

TRANSPORTATION  
LIBRARY

TL  
686  
B56  
U58  
1944

# PILOT TRAINING MANUAL

FOR THE BLACK WIDOW

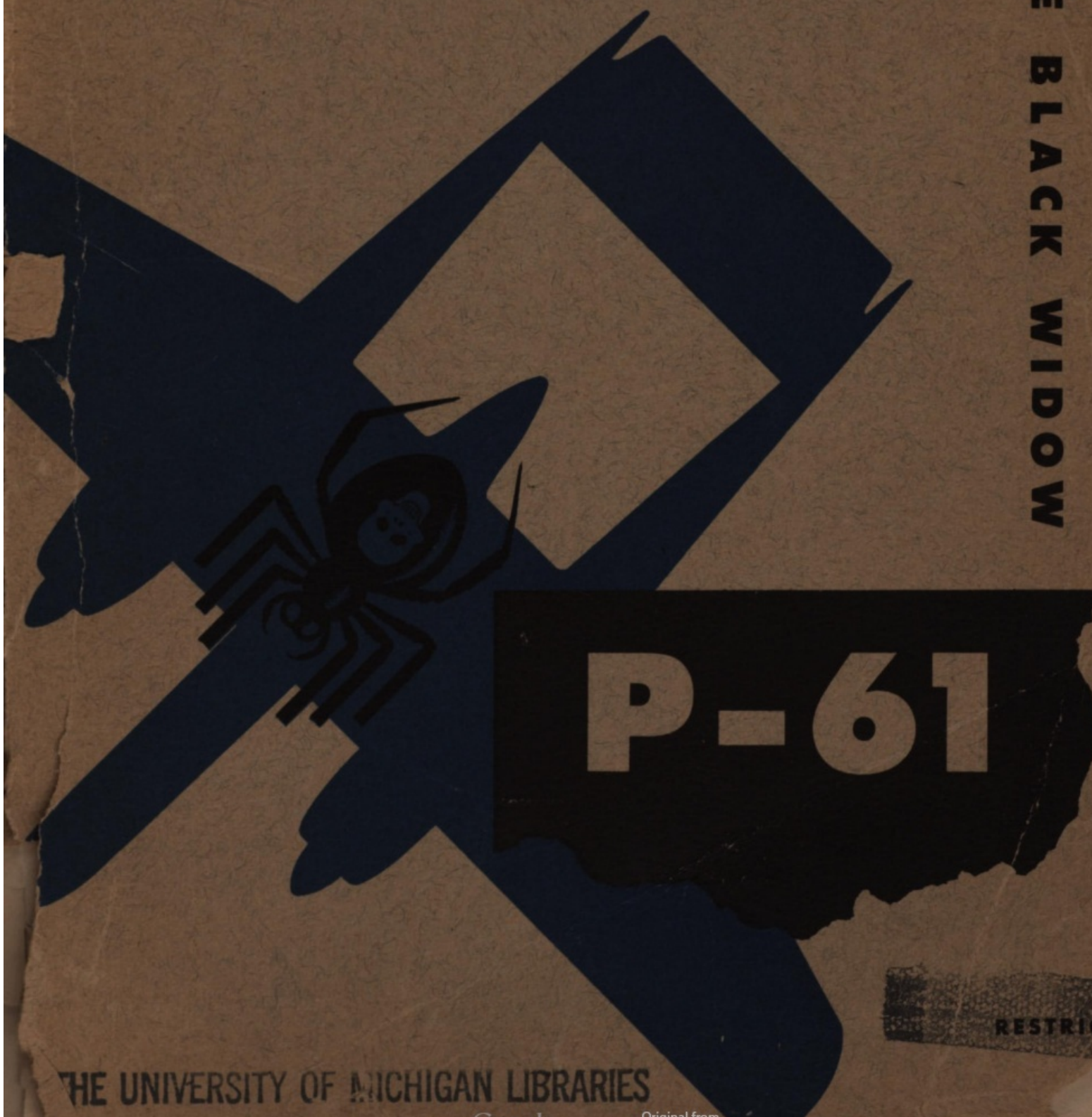

# P-61

RESTRICTED

THE UNIVERSITY OF MICHIGAN LIBRARIES

Digitized by Google

Original from  
UNIVERSITY OF MICHIGAN

RESTRICTED

# PILOT TRAINING MANUAL

## FOR THE BLACK WIDOW

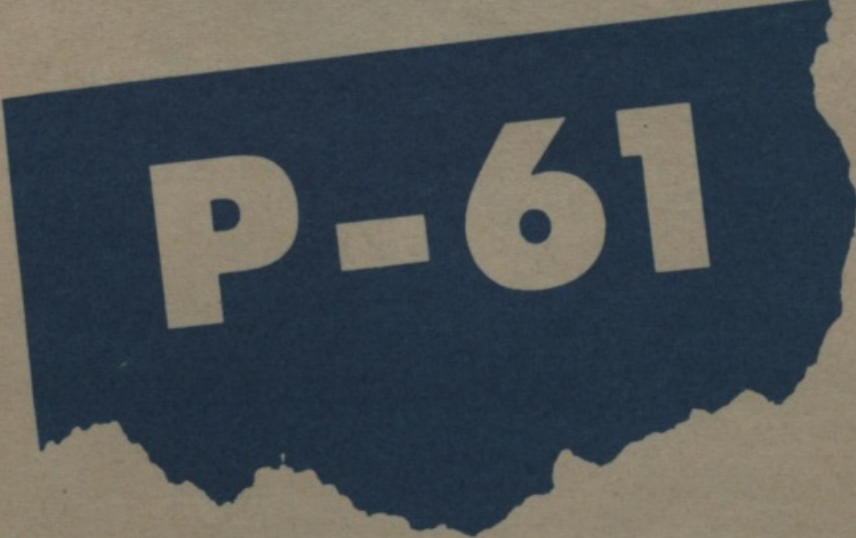

**P-61**

PREPARED FOR HEADQUARTERS AAF

OFFICE OF ASSISTANT CHIEF OF AIR STAFF TRAINING

---

BY HEADQUARTERS AAF, OFFICE OF FLYING SAFETY

RESTRICTED

Emigration  
Library

TL

686

B56

U58

1944



# Foreword

THIS MANUAL is the text for your training as a P-61 pilot and airplane commander.

The Air Forces' most experienced training and supervisory personnel have collaborated to make it a complete exposition of what your pilot duties are, how each duty will be performed, and why it must be performed in the manner prescribed.

The techniques and procedures described in this book are standard and mandatory. In this respect the manual serves the dual purpose of a training checklist and a working handbook. Use it to make sure that you learn everything described herein. Use it to study and review the essential facts concerning everything taught. Such additional self-study and review will not only advance your training, but will alleviate the burden of your already overburdened instructors.

This training manual does not replace the Technical Orders for the airplane, which will always be your primary source of information concerning the P-61 so long as you fly it. This is essentially the textbook of the P-61. Used properly, it will enable you to utilize the pertinent Technical Orders to even greater advantage.



GENERAL, U. S. ARMY,  
COMMANDING GENERAL,  
ARMY AIR FORCES



## HISTORY OF THE AIRPLANE

The plane you will soon fly was born for the job it has to do. The P-61 is the first American airplane designed and built to fly and fight at night.

Though for security reasons the Army Air Forces did not let the world know there was such a plane until January 9, 1944, when one flew over the Los Angeles Coliseum at an Army-Navy show, it existed in drawings as early as November, 1940.

Late in the gloomy fall of that tragic year, a top-ranking Army officer returned from England with a list of what the British and, incidentally, the Americans needed in the way of armament. He had been an anxious observer during the Battle of Britain. High on the list of requirements he compiled was a night fighter. He had watched the British make valiant use of converted pursuits and light bombers in trying to defend themselves against night raiders. These planes were not adequate.

What was needed was a new type of airplane. It should be able to prowl in the dark, inter-

cepting enemy bombers before they could reach their objective, shooting them down as they attempted to return to their bases. But it was to do more than that. It should play an offensive role, too, intruding on the enemy and destroying his installations by night or on days too murky for the average plane to fly a mission.

To meet these specifications, the new night fighter must have excellent radar equipment and extensive radio installations of other kinds. It must be fast in flight but able to land at slow speeds on barely visible runways. It must be highly maneuverable but exceptionally stable, for its pilot would need to fly for long periods strictly on instruments, without having to make continual corrections. Most important of all, it must have extremely heavy firepower, enough to be certain of blasting an enemy plane out of the sky in the crucial few seconds of night interception.

This night fighter also had to have adequate accommodations for extensive equipment, and places for a pilot, gunner, and radar operator.

## RESTRICTED

It was to be designed around the Pratt & Whitney R-2800 engine, then new, or the Wright R-3350 engine. Both of them are radial air-cooled engines of about 2000 horsepower (Hp).

When the P-61 finally emerged from the long ordeal of creation through which every airplane must go before Army or Navy acceptance, it had two 2000 Hp engines and two tail booms. This was one design. There was another with a single tail. The Army decided the less conventional model was superior.

Officials of Northrop Aircraft, Inc., which builds the P-61, flew East in November, 1940, for initial conferences about the first real night fighter plane. As a result of these talks, the original designs were made. Again there were conferences, and changes. A wooden mockup was built. Twenty six experts from the U. S. Army and Navy and from the Royal Air Force visited the factory and inspected the mockup. There were more changes as a result. Wind-tunnel models were made and tested. At last, the basic layouts were agreed upon and fixed. Then, factory engineers in groups went to work on the various parts of the plane which were their specialties: armament, controls, electrical equipment, crew nacelle, hydraulics, landing gear, and so forth. The stress group set out to calculate the loads the P-61 would be forced to withstand in flight. The test group soon began

testing sub-assemblies to make sure they were strong enough to carry their design loads.

The manufacturer received an order for two XP-61 airplanes on January 30, 1941. These were the two experimental models the AAF Materiel Command customarily orders when considering the purchase of a new airplane. Normally, when the experimental models have been built and satisfactorily flight tested, the Y or service test order is given. That order is for 13 airplanes plus one static test plane. The 13 Y's go to the Army Air Forces for more tests, under service conditions. The static model has no engines or instruments. It consists only of load-carrying structures. It is sent to Wright Field, where it undergoes a wide variety of tests to find out how strong it is and what load will ultimately destroy it.

However, the XP-61 looked good on paper. Furthermore, the night fighter was urgently needed. So Army Air Forces officials decided to take the risk of departing from their usual procedure in acquiring a new airplane. An order for the Y series of service test P-61's was awarded 38 days after the XP order. The first production contract, calling for hundreds of P-61's, was signed on February 26, 1942, even before the first experimental model was flown.

That first experimental model was finished May 8, 1942. It was painted a shiny black, with red serial numbers and red inspection door

6

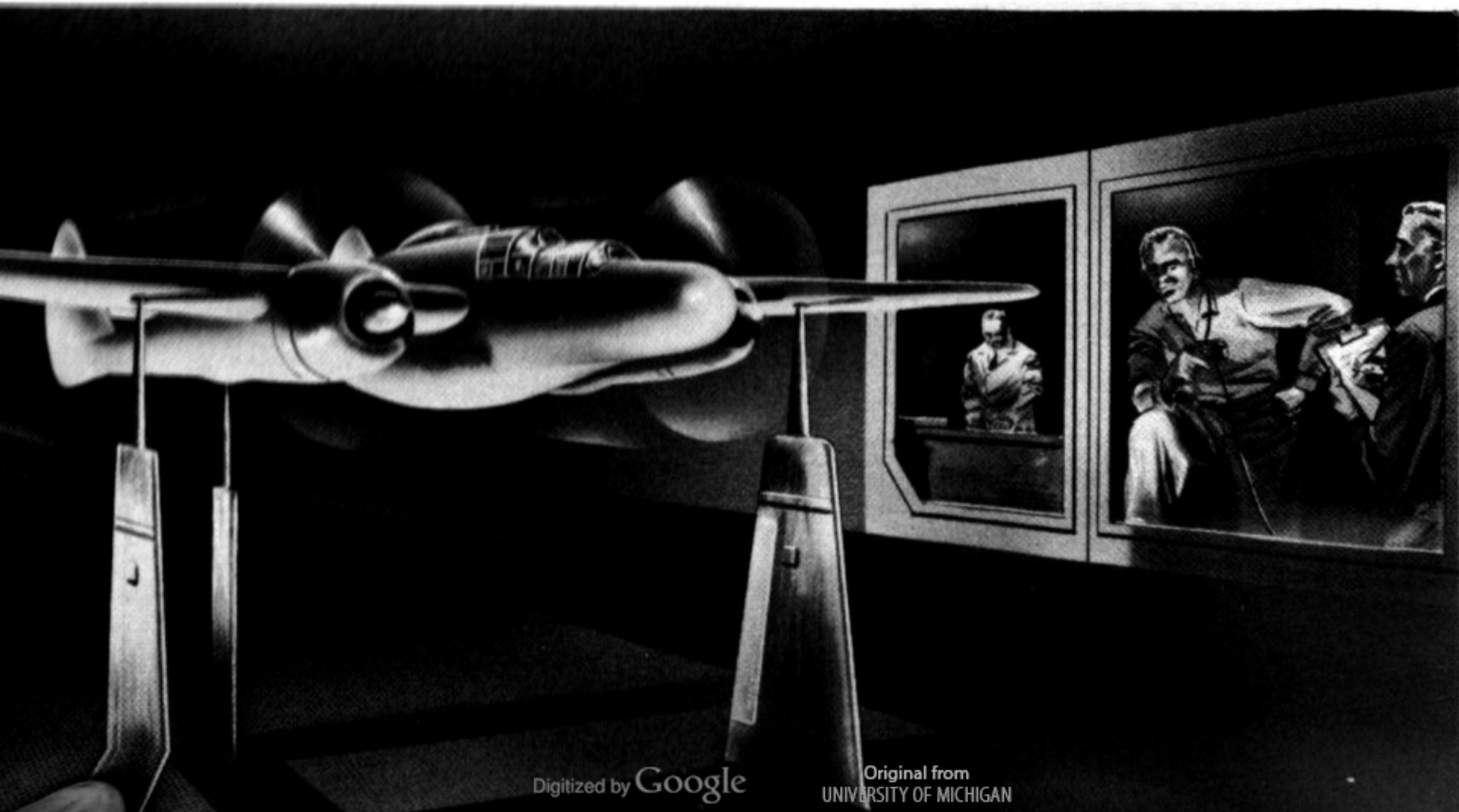



markings. Within a few hours after it was wheeled from the experimental department onto the main assembly floor at the factory, workers had christened it the Black Widow.

Like the deadly spider for which it was named, the Black Widow lurks in the dark, attacks unseen, and cuts down its prey with powerful venom. Its four .50-cal. machine guns and four 20-mm. cannon spit almost certain death at any enemy which comes within range.

P-61's are in action in the Pacific and in Europe. They made a spectacular debut in France. On their first missions, they wiped out four German raiders. One Black Widow downed a Messerschmidt-110 after a 23-minute battle at such close range the planes sideswiped each other. Afterwards, a P-61 pilot boasted:

"We'll take on any day fighter made."

The P-61 is conventional in design, except for its full-span flaps, spoiler-type ailerons, and booster-type elevator tabs. It had to have a lot of flap area to land at the exceptionally slow speed specified. The airplane can land at less than 80 mph. To make this possible, the flaps were extended into the part of the wings where the ailerons usually are placed. Therefore, the engineers had to design a new type of control to take the place of the aileron. What they did was to create a curved spoiler plate hinged along the upper surface of the wing. It has holes in it to lighten its weight. It extends along the outer two-thirds of the outer wing. In addi-

tion, on the P-61A there is a small trim tab, about 40 inches long, which is like the usual aileron both in shape and movement. One authority on airplanes called the spoiler type aileron control "the aileron control of the future."

Non-adjustable spring tabs on the elevators reduce control forces, especially at high speeds.

There was one requirement specified for a night fighter which the P-61 has not yet met satisfactorily: flame damping of the engine exhausts to eliminate glow in the dark. There have been many attempts to solve the problem perfectly. They are still being made and undoubtedly the answer will soon be found. At the present time, however, the flame damping is only fair. It represents the best compromise to date between good damping and good serviceability of the exhaust stacks and jet exhaust.

Pilots, both American and Allied, who have flown the P-61 generally are enthusiastic about the airplane. The only major unfavorable comment has been that the P-61A does not have sufficient range. That criticism is being met by equipping the airplane with external wing racks capable of carrying gasoline tanks in various combinations up to four 310-gal. tanks. These same racks can carry four 1600-lb. bombs, if they seem to be more important at times than the approximately 1800 extra miles of range which four 310-gal. tanks of gasoline provide.

**Other changes built into the P-61B include:**

1. Mechanically operated main landing gear doors, in place of the A model's hydraulic ones.
2. Bigger and better heater units for the crew nacelle.
3. Automatically operated lower engine cowl flaps, oil cooler air exit flaps, and intercooler flaps.
4. Night binoculars.
5. A main landing gear down-lock emergency release. The pilot now can trip the down locks in an emergency, even with the entire hydraulic system out.
6. A safety latch on the main landing gear hydraulic valve handles. This eliminates the possibility of tripping the gear on the ground.
7. Oil tanks in the engine nacelles instead of the outer wings.
8. Taxiing lamp added to landing gear strut.
9. Built-in fire extinguishing system.
10. Natural position trim tab controls. These rudder and elevator tab controls operate in the same plane as the change of trim desired.

11. An absolute altimeter.

12. A new gun camera (N-6).

13. Cannon chute ejection doors are being eliminated. The cannons no longer can jam because the ejection doors fail.

14. The aileron tab is being removed entirely. The Army requested this change, for it feels there is not sufficient need for a lateral trimming control.

The Black Widow is still painted shiny black, as she was when the first experimental model won the name which the plane bears. There is an excellent reason for this. You might think dull black would be harder to see at night. Actually, dull black looks almost white in searchlight beams. However, when those long blue-white pointers pick up a shiny black airplane they bounce right off it. It is almost impossible to see the plane.

When the Black Widow takes to the night sky, sticking her long nose into whatever trouble lies there, she is hard to see, hard to hit, and **hard to beat.**







## GENERAL DESCRIPTION

This is how the P-61 differs from the P-70:

In the first place, it has two tail booms and looks like an overstuffed P-38. It has a larger and roomier cockpit than the P-70. Its combat weight is roughly 8000 to 10,000 lbs. heavier. Its wing span is 66 feet, compared to the P-70's 61½ feet. Its length (nearly 49 feet) is only 1 ft. longer than the P-70. It feels heavier than the P-70, but is actually much more maneuverable in flight, smoother and more stable.

The relative positions of pilot and radar ob-

server (RO) in the P-61 remain the same as in the P-70. In the P-61, however, a gunner is added to operate the turret.

Without bomb bay tanks (P-70) or external wing tanks (P-61), the two planes are similar in range and endurance. In speed, the P-61 has the edge over the P-70 at all altitudes. The P-61 also climbs much faster than the P-70, especially above 15,000 feet. The arrangement of instruments and controls in the P-61 is quite different from that of the P-70.

RESTRICTED

9

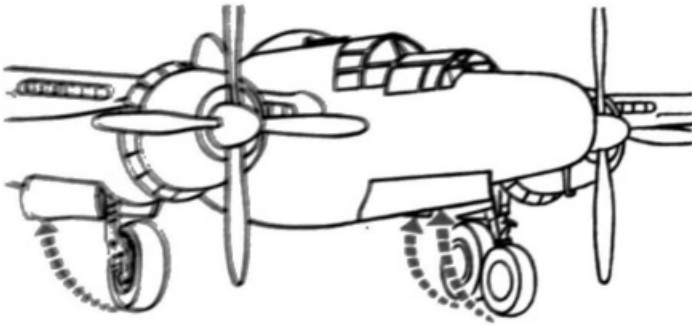

**Structure**

You already know the wing span and length of the P-61 and the fact that it has two engines, two tail booms, and two vertical stabilizers. It is an all-metal, midwing monoplane with tri-cycle landing gear. The main landing gear retracts to the rear and into the engine nacelles by hydraulic pressure. The nosewheel retracts hydraulically into the forward part of the crew nacelle. The P-61 has a stressed-skin, 2-spar, cantilever wing. You can get at the interior of the wing through removable doors.

The pilot and gunner enter their forward compartment by a ladder attached to the front entrance door. That's located in the nosewheel well. The door has a latching handle and opens down. To close the door, first step on the rod that folds the ladder. Then pull the door up and turn the latch to secure it.

The RO enters his compartment by means of a ladder attached to the rear entrance door in the bottom of the crew nacelle. He opens the door by pressing a large red button in the bottom of the nacelle just forward of the plexiglas tail cone. When he pulls the door up after him, it closes securely as it latches.

There are dual hydraulic disk-type brakes on each main gear wheel of the P-61. These provide twice the braking surface of the P-70 and, consequently, are much more sensitive to operate. There is an emergency air brake system which you can use if the hydraulic system fails.



**Engines**

The airplane has two 2,000 Hp Pratt & Whitney engines. They are 2-stage, 2-speed, super-charged engines, designed to operate on Grade 100-130 fuel **only**. These engines are either Model R-2800-10 or R-2800-65. The difference lies in the magneto and ignition systems.



**RATIO**

Compression ratio	6.65:1
Main blower gear ratio	7.80:1
Auxiliary blower LOW gear ratio	6.46:1
Auxiliary blower HIGH gear ratio	7.93:1
Propeller gear ratio	.500

**OIL PRESSURE**

Desired, at 2000 rpm at 60°C	75-80 psi
Maximum, at 2000 rpm at 60°C	90 psi
Minimum, at rated rpm at 100°C	75 psi
Minimum, at 2100 rpm at 85°C	60 psi
Minimum, at 1200 rpm at 85°C	50 psi
Minimum, at idling	25 psi

**OIL TEMPERATURES**

Minimum, for takeoff and flight	40°C
Desired	60°-75°C
Maximum, level flight	85°C
Maximum, climb	100°C

**FUEL PRESSURE**

Desired	16 psi
Allowable	15-17 psi
Minimum	15 psi

## RESTRICTED

### Water Injection

The actual fuel mixture which the P-61 uses at maximum power is too rich. This is necessary to keep the engines cool. If the mixture were leaned to best power, the maximum horsepower would increase about 15%. The engines, however, would burn up quickly.

By using water injection you accomplish nearly the same result with no harm to the engines. The cooling lost in leaning the fuel mixture is made up for by the water vapor added. In water injection, water containing about 30% alcohol to prevent freezing at high altitudes is actually mixed with gasoline before it enters the engines.

To operate the water injection feature of your plane, first push the throttles wide open. In the wide open position, they turn on a water pump in each engine, though the water pressure does not yet rise above its normal 3 to 5 psi. Just forward of the throttles there is a small lever. This lever is a switch that turns on the water supply to the engines and at the same



time leans out the fuel mixture. When you have pushed the throttles wide open, flip the lever to the left with your thumb. With the water injection feature in use, the water pressure gage at the right of your cockpit should now register 17 psi. If your water supply becomes exhausted, be sure to turn off the water injection system.

It is not practical, though it is possible, to test the water injection system while the plane is on the ground, for to do so you must open the throttles wide. You can test it in the air, however, without worrying about blowing other planes into a scrap heap with your prop wash. At an altitude where you can get military power (54" Hg. manifold pressure and 2700 rpm), water injection, if it's working properly, increases your manifold pressure to 60" Hg. and you can definitely feel the plane accelerate.

Never use water injection for more than 5 minutes at a time. Remember, it's your war emergency power. Save it (and the engine) for war emergencies.

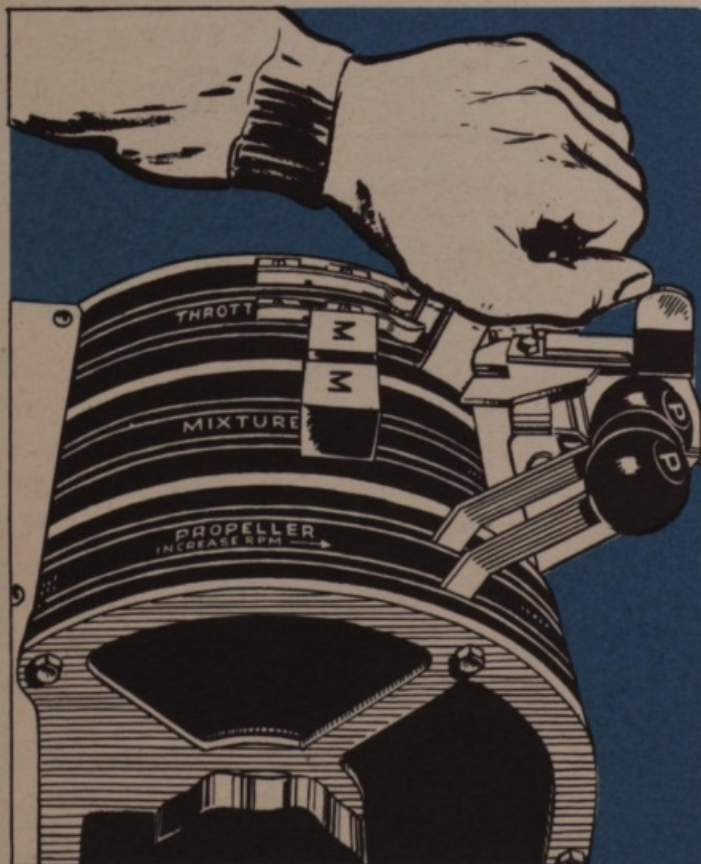

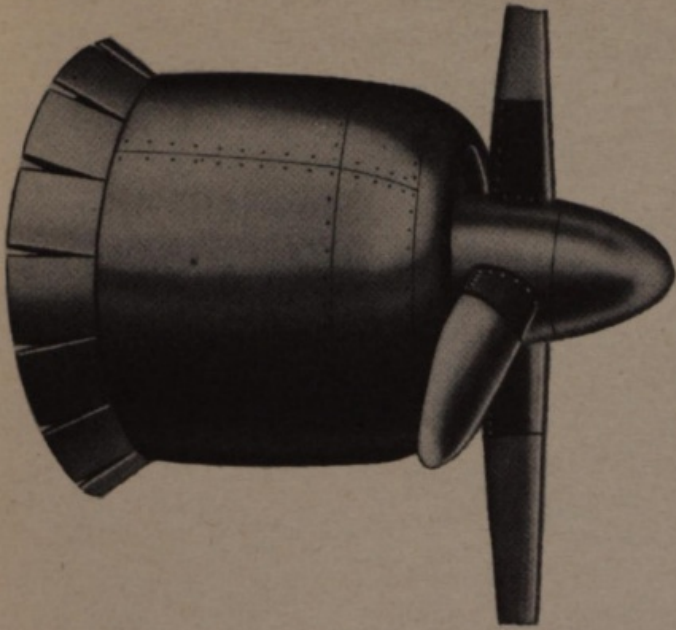

This type of circuit breaker is designed to carry extremely high loads when you hold the button in. By making careful use of this feature, you may set the propeller blades at a satisfactory angle in spite of a damaged or overloaded propeller circuit. **But don't hold the button in except in an emergency.**

#### Fixed Pitch Operation

Normally, there is no reason to fly the P-61 with its propellers in fixed pitch position. However, your generators or the voltage regulator system may become damaged so that the batteries won't charge. If this happens, you'll want to save the current normally used in holding the propellers at constant speed for more valuable use in keeping the radios going. Accordingly, you set the propeller selector switch at the **FIXED PITCH** position.

#### Propellers

The P-61 engines operate two Curtiss electric, full-feathering, 4-bladed propellers, 12 feet 2 inches in diameter. The angle of the propeller blade is controlled automatically or manually. Normally, you control the propellers with the automatic constant-speed system. This system keeps the engines running at a constant speed, no matter what the throttle setting is. When the manual control system is used, you decrease or increase the blade angle by moving the propeller selector switch.

The propeller circuit breakers are of the push button type. You can't open them by hand after you've set them, but you must re-set them if an overload opens them. When a circuit breaker opens because of an overload on the propeller circuit, the blades remain at a fixed angle setting. Therefore, it is essential, in this event, that you re-set the circuit breaker to the **ON** position.

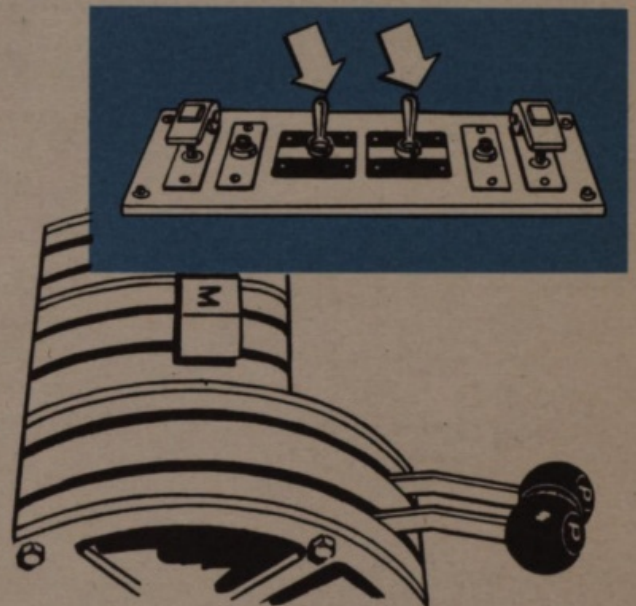
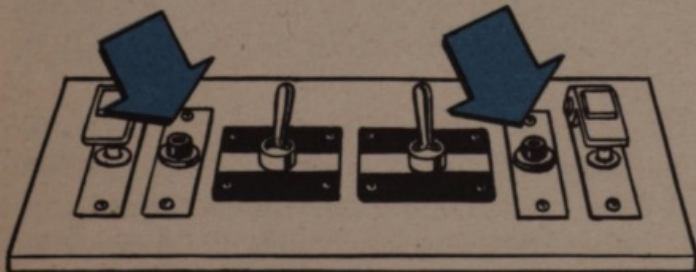

However, as you know, with the propellers at a fixed pitch, you must increase the engine rpm whenever you want to climb, and decrease it when you want to descend. To do this, hold the propeller selector switch either in the **DECREASE** or **INCREASE** position until the desired rpm is reached. Remember that the selector switch is spring-loaded. As soon as you let it go, it snaps back to the **FIXED PITCH** position.

**Never, under any circumstances, take off in a P-61 with the propellers at fixed pitch. Never land with them at fixed pitch, either, except in an emergency.**

**FUEL LINES**
  
**DRAIN LINES**
  
**VENT LINES**

1. PRIMER SWITCH
2. BOOSTER PUMP SWITCHES
3. CROSS FEED CONTROL
4. R.H. TANKS CONTROL
5. L.H. TANKS CONTROL
6. DRAIN COCK
7. CROSS FLOW VALVE
8. ELECTRIC FUEL PRIMER
9. CARBURETOR
10. DRAIN
11. STRAINER
12. VENT
13. FUEL PUMP
14. FUEL SELECTOR VALVE
15. AIR SCOOPS
16. BOOSTER PUMP
17. SIPHON BREAKER

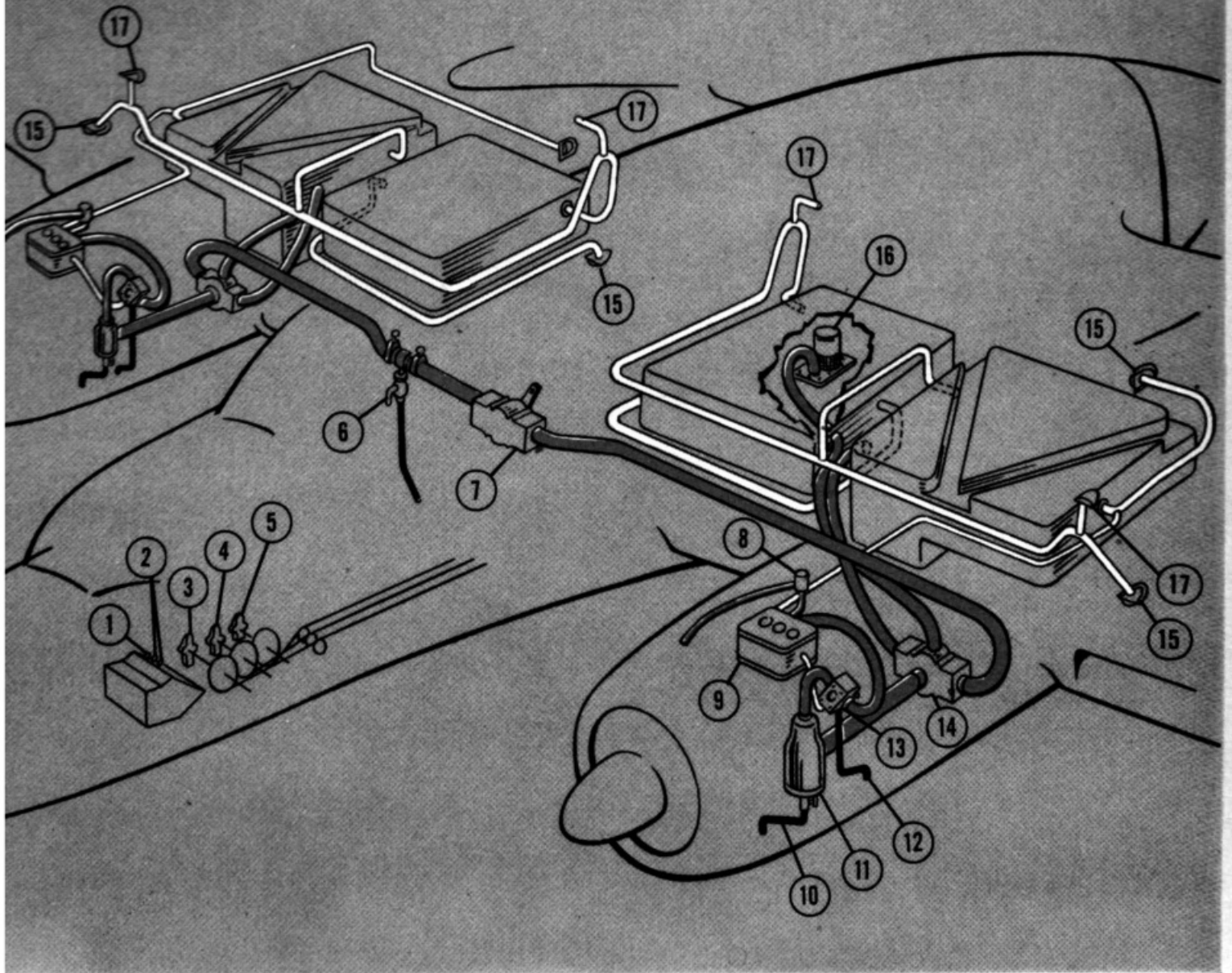

### Fuel and Oil System

The P-61 has four self-sealing fuel tanks built in the wings. The total capacity of these tanks is 630 U.S. gals. (522 Imperial gals.). Each out-board tank holds 200 U.S. gals.; each inboard tank, 115 U.S. gals. You can use fuel from any

tank desired, but it is customary to use the right-hand tanks for the right engine, and the left-hand tanks for the left engine. There is a gage which tells you how much fuel there is in each tank. All built-in fuel and oil tanks on the plane are filled from the top of the wing.

Each tank has an electrically operated, 2-

1. OIL DILUTION VALVE
2. OIL IN
3. OIL OUT
4. OIL HOPPER
5. OIL FILTER CAP
6. OIL TANK
7. OIL TEMP. REGULATOR
8. OIL COOLER
9. COOLER DRAIN
10. OVERFLOW
11. OIL SUMP
12. SUMP DRAIN
13. OIL COOLER AIR INTAKE
14. CARBURETOR AIR INTAKE

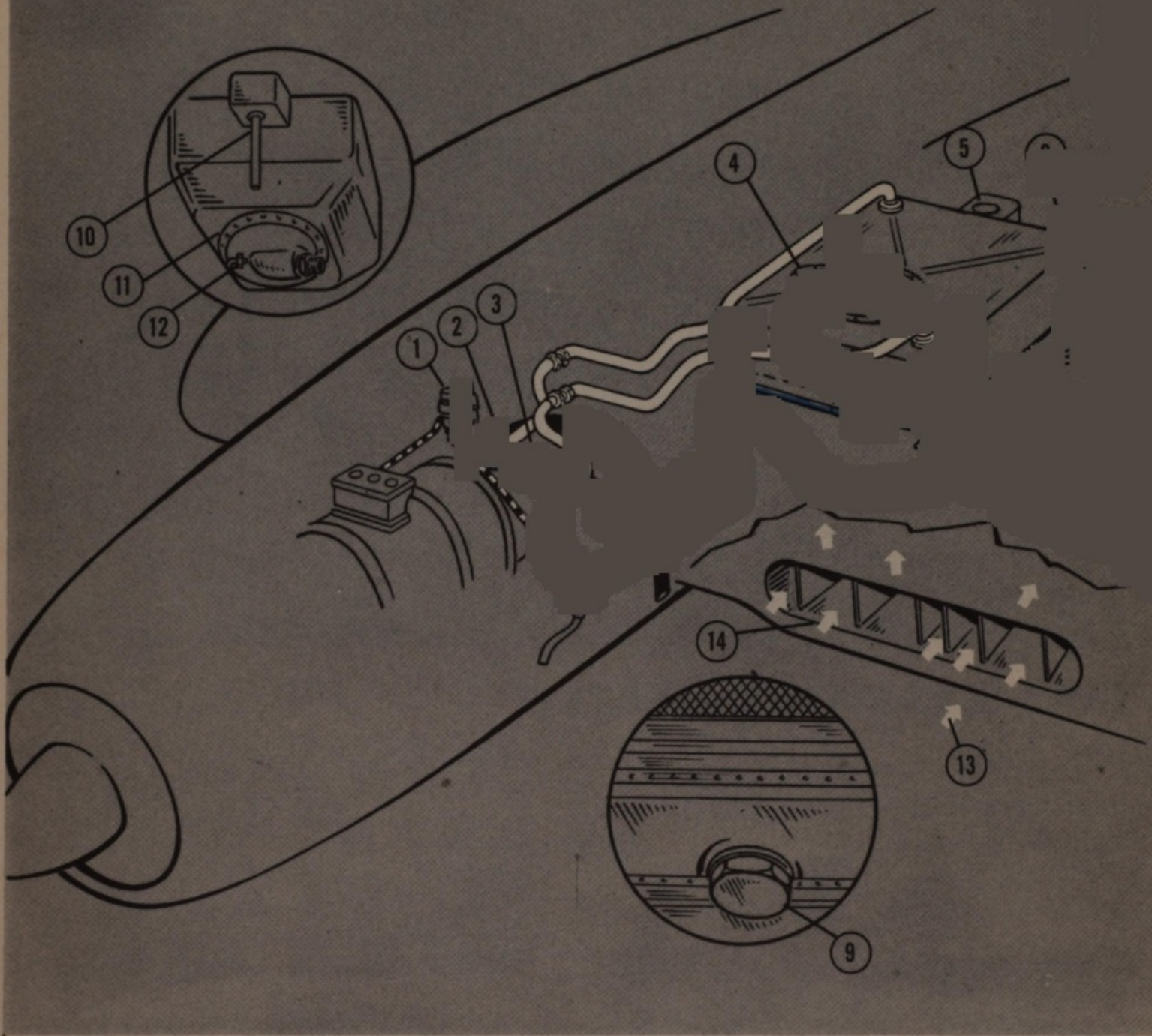
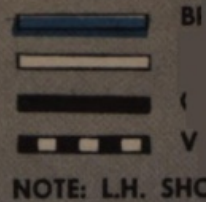

speed booster pump which you may use to supply fuel to the engine-driven pumps. Normally, the booster pumps are not used while the airplane is cruising, unless fuel pressure is low. The booster pumps operate either in LOW or HIGH position and, if the engine-driven pumps fail, you may use the boosters to supply fuel to

the engines.

A crossfeed valve permits fuel to flow under pressure from one tank to another. Accordingly, you can quickly transfer fuel from a damaged tank to another tank.

The P-61A has one 22-gal. (U.S.) self-sealing oil tank in each outer wing panel.

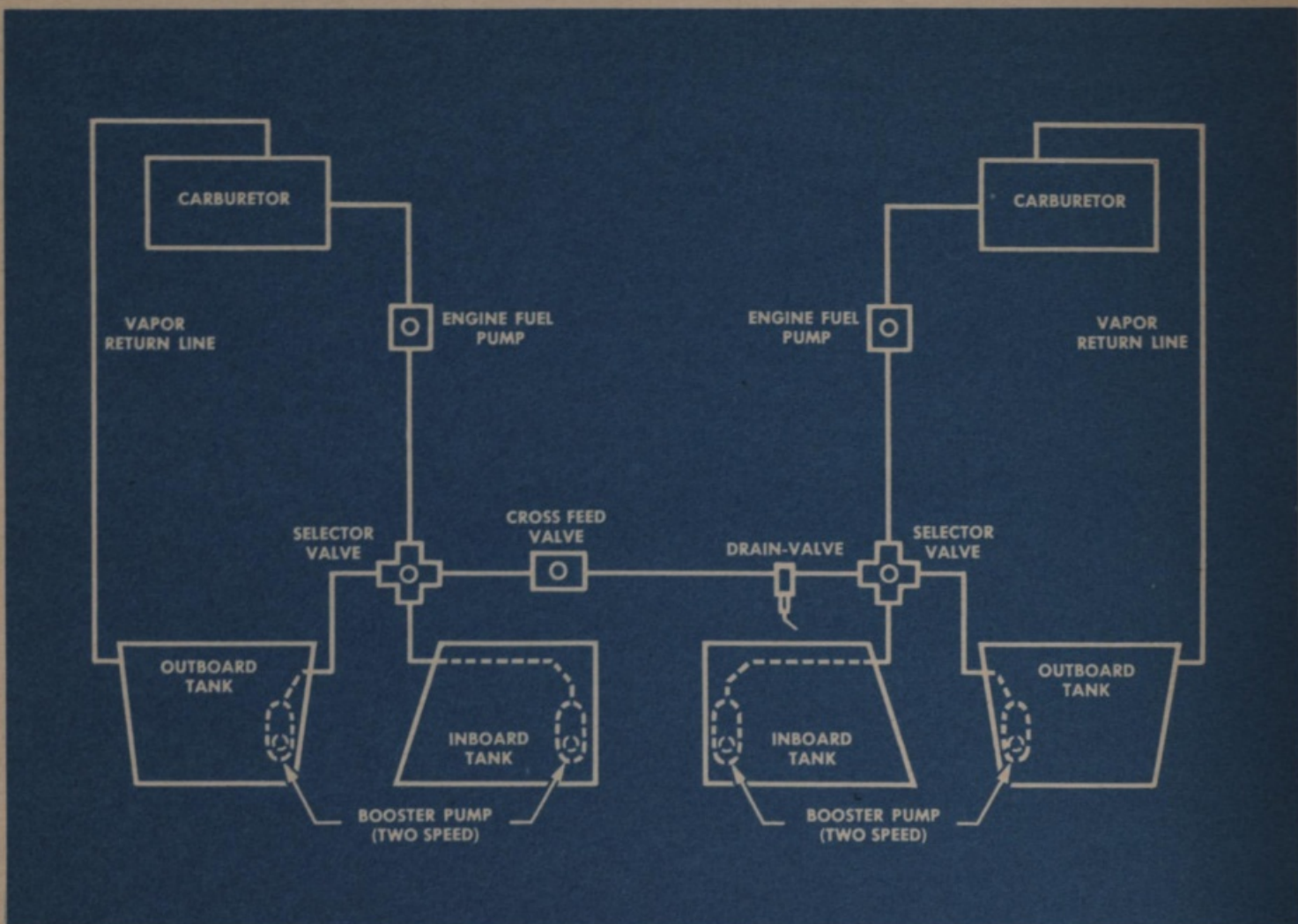

## FUEL TRANSFER SYSTEM

How to Operate Both Engines  
from One Fuel Tank

1. Turn fuel selector valve to tank desired.
2. Turn fuel booster pump on that side to HIGH.
3. Turn crossfeed valve ON.
4. Turn other fuel selector valve to OFF.
5. Turn other fuel booster pump OFF.

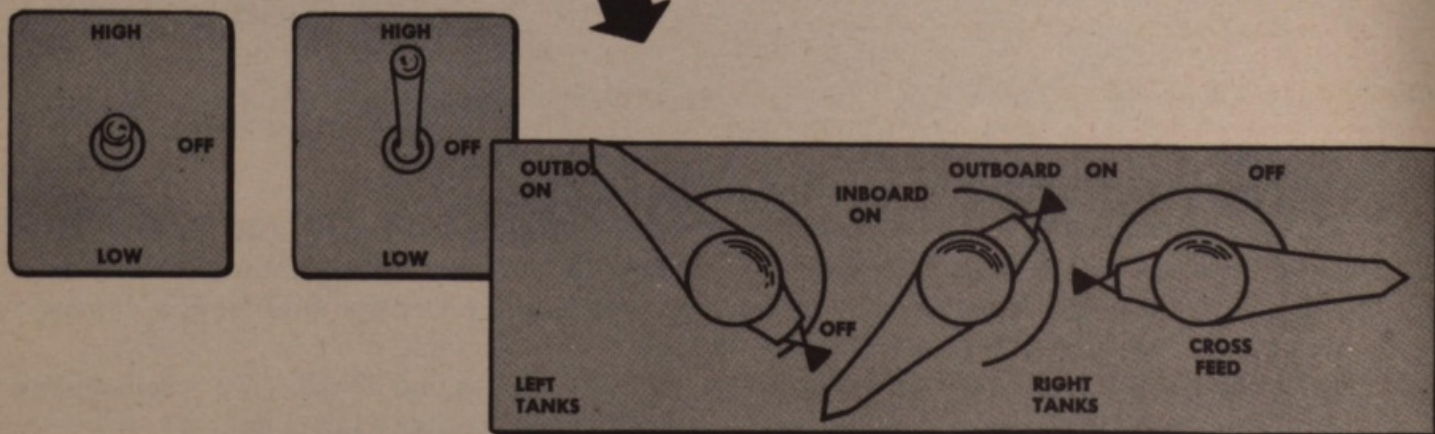



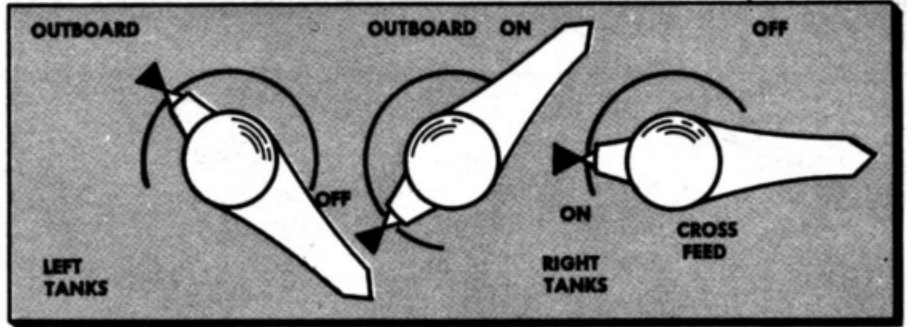
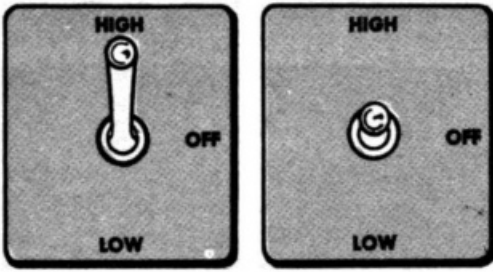

**How to Operate An Engine from An Opposite Tank**

1. Turn fuel selector valve to tank desired.
2. Turn fuel booster pump on that side to HIGH.

3. Turn crossfeed valve ON.
4. Turn other fuel selector valve OFF.
5. Turn other fuel booster pump OFF.
6. Place mixture control for dead engine in IDLE CUT-OFF.

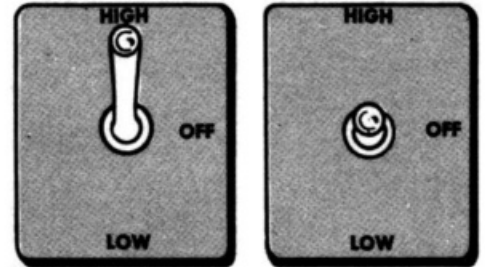
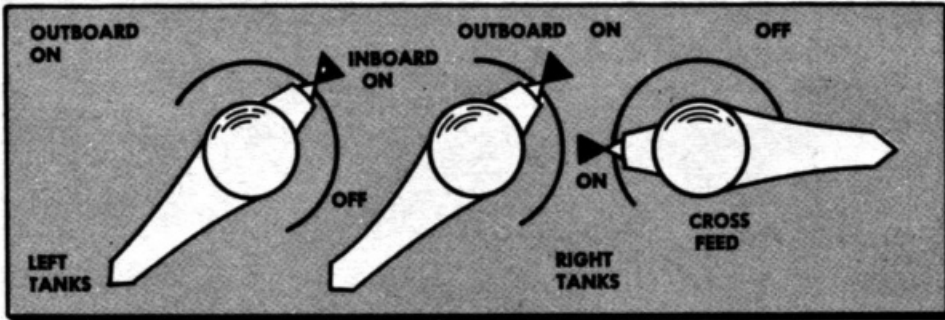

**How to Transfer Fuel**

1. Turn one selector valve to the tank you want to drain.
2. Turn the other selector valve to the tank which is to receive fuel.

3. Open the crossfeed valve.
4. Turn booster pump switch for the tank you want to empty to HIGH. Turn other booster pump switch OFF.
5. When you're through transferring fuel,

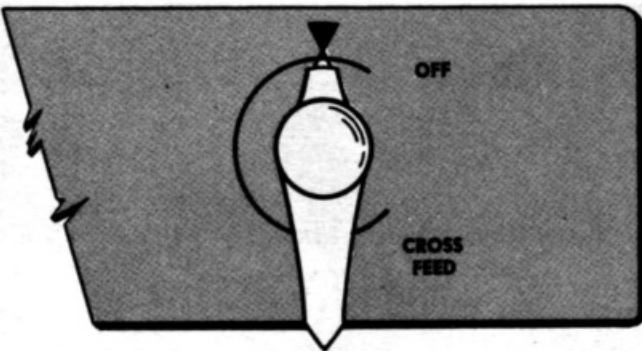

**Cross Feed Values**



reset the booster pump switches and selector valve switches for normal operation. Close the crossfeed valve.

Keep the crossfeed valve in OFF position for all normal operations.

Place your fuel booster pump switches in HIGH to get adequate fuel pressure for high altitude maneuvers. Put them in the LOW position in all normal flight operations in which you need additional pressure for the engine fuel pumps. For "hovering" flight, you don't need the fuel booster pumps at all.

**Fuel Booster Pump Switches**

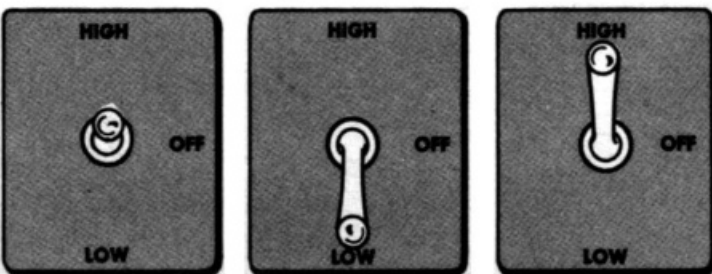

Hovering Flight

Normal Flight

High Altitude

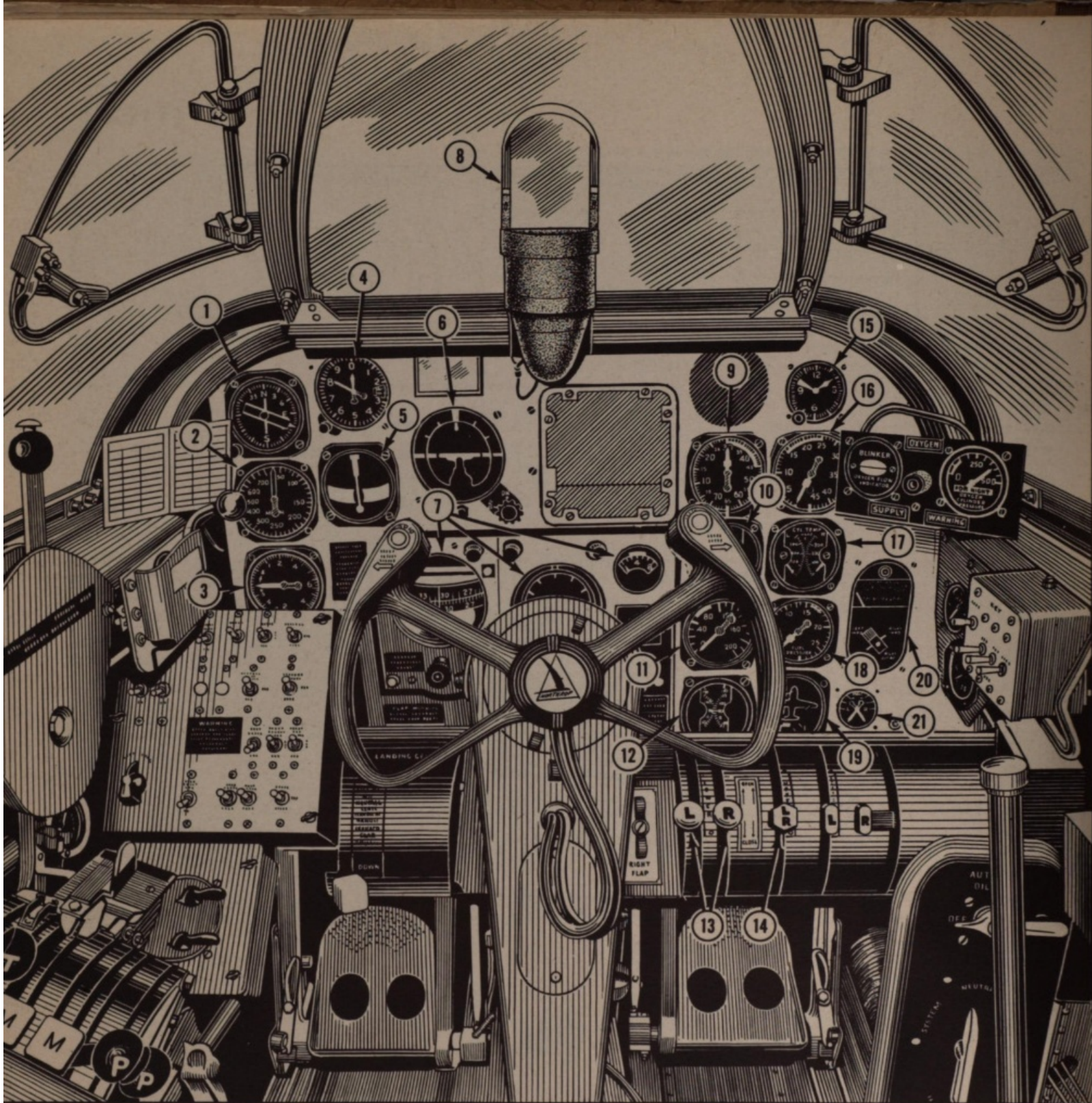

### Controls, Switches, Instruments (Front Panel)

- |                             |  |   |
|-----------------------------|--|---|
| 1. Remote compass           | 9. Manifold pressure indicator           | 15. Clock                               |
| 2. Airspeed indicator       | 10. Oil temperature indicator            | 16. Tachometer                          |
| 3. Rate of climb indicator  | 11. Oil pressure indicator               | 17. Cylinder head temperature indicator |
| 4. Altimeter                | 12. Carburetor air temperature indicator | 18. Fuel pressure indicator             |
| 5. Turn and bank indicator  | 13. Lower cowl flaps control valves      | 19. Wheel and flap position indicator   |
| 6. Gyro horizon             | 14. Upper cowl flaps control valve       | 20. Fuel gage                           |
| 7. Dials of automatic pilot |  | 21. Oil cooler flap indicator           |
| 8. Pilot's gunsight         |  |   |

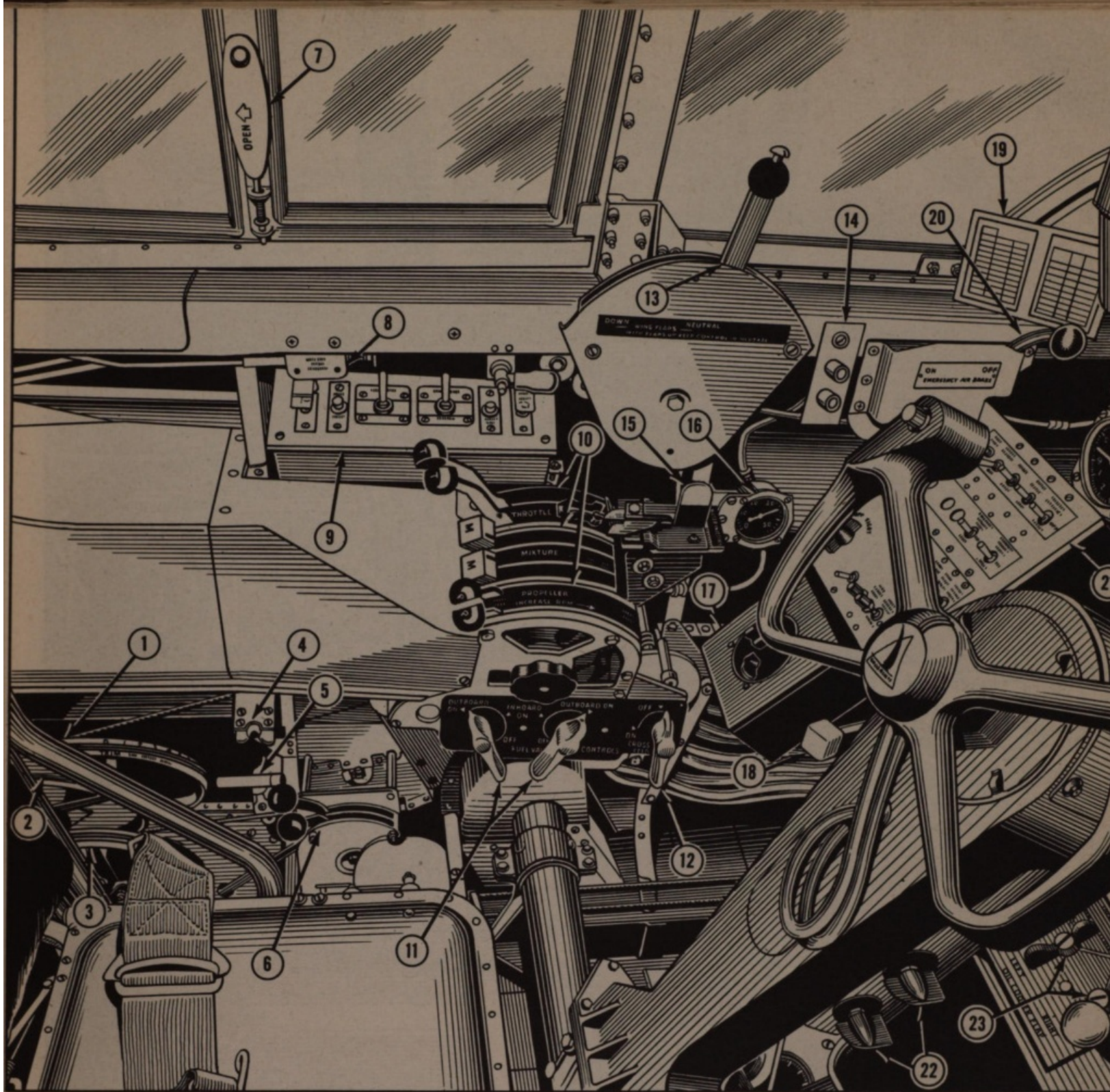

**Controls, Switches, Instruments (at Pilot's Left)**

- |  |  |                                       |
|--|--|---------------------------------------|
| 1. Aileron trim tab wheel              | 9. Pilot's propeller control panel     | 16. Emergency air brake pressure gage |
| 2. Elevator trim tab wheel             | 10. Engine control quadrant            | 17. Box assembly ignition switch      |
| 3. Rudder trim tab wheel               | 11. Fuel selector valve controls       | 18. Landing gear selector valve       |
| 4. Emergency release handle support    | 12. Fuel tank cross flow valve control | 19. Correction card holder            |
| 5. Main landing gear emergency release | 13. Flap control lever                 | 20. Emergency air brake lever         |
| 6. Supercharger controls               | 14. Flap position warning lights       | 21. Pilot's electrical switch panel   |
| 7. Left window latch                   | 15. Water injection control switch     | 22. Fluorescent light switches        |
| 8. Landing gear warning horn release   |  | 23. Oil cooler flap switches          |

**RESTRICTED**

19

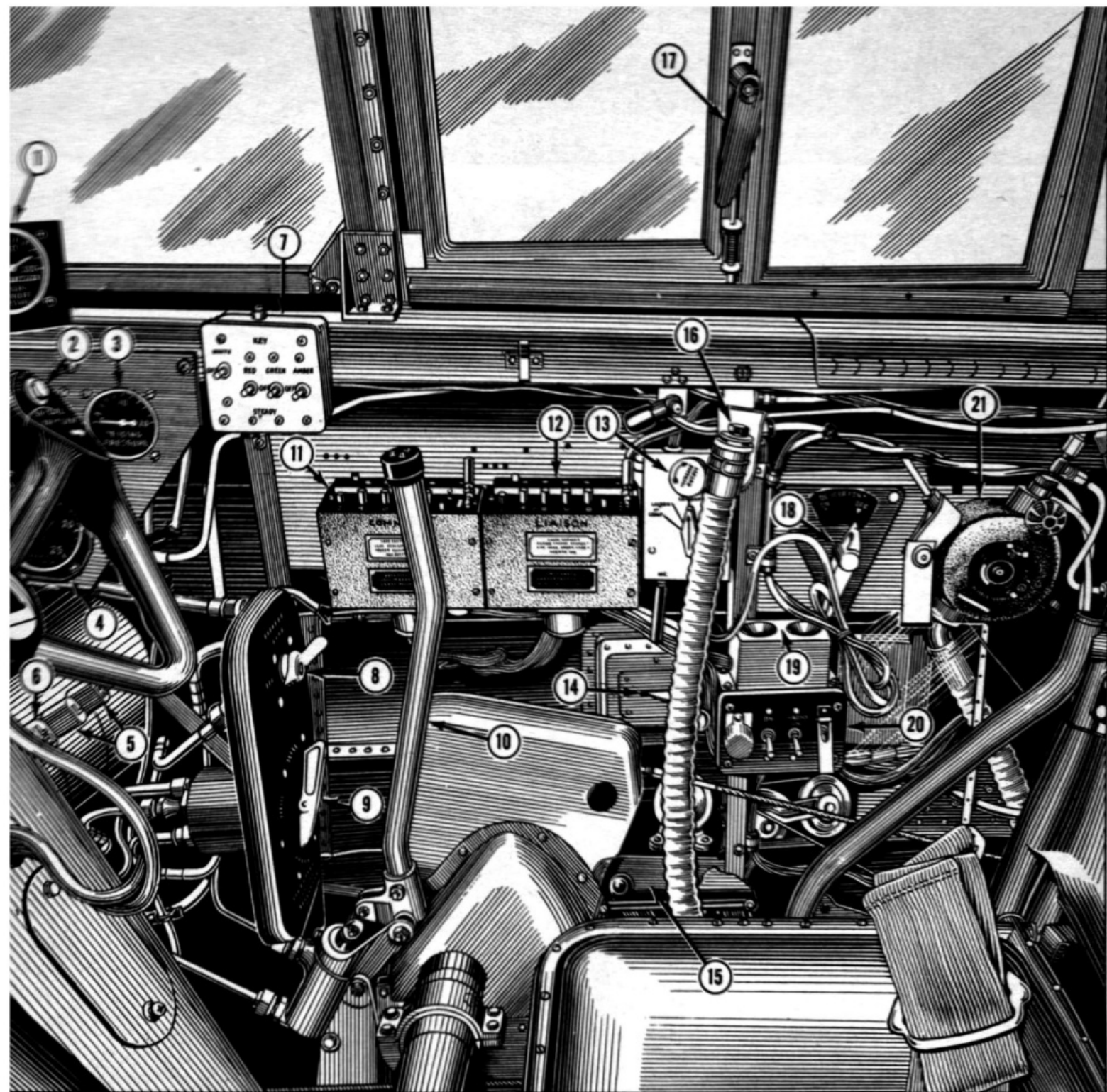

### Controls, Switches, Instruments (at Pilot's Right)

- |                                    |   |  |
|------------------------------------|---|--|
| 1. Oxygen pressure gage            | 8. Automatic pilot pressure valve             | 14. Pilot's ventilator                               |
| 2. Cannon firing button            | 9. Hydraulic hand pump selector valve         | 15. Automatic pilot master control                   |
| 3. De-icer air pressure gage       | 10. Hydraulic hand pump handle                | 16. Pilot's oxygen tube                              |
| 4. Water injection pressure gage   | 11. Command radio control box (SCR-522 No. 1) | 17. Right window latch                               |
| 5. Intercooler door control valves | 12. Liaison radio control box (SCR-522 No. 2) | 18. De-icer control valve                            |
| 6. Upper cowl flap control valve   | 13. Interphone jack box                       | 19. Destructor switch                                |
| 7. Recognition light control box   |   | 20. Identification radio (IFF) control box (SCR-695) |
|                                    |   | 21. Oxygen regulator                                 |



**Armor and Armament**

The P-61 has bullet-resistant glass plates, armor plates, and deflector plates which protect the crew and ammunition from .30-cal. and .50-cal. machine gun fire.

The plane's armament consists of four 20-mm. cannon in fixed positions in the bottom of the crew nacelle and four .50-cal. machine guns in a remote control turret on top of the crew nacelle. (Some planes of the P-61A and P-61B series do not have this gun turret). Two hundred rounds of ammunition are carried for each 20-mm. cannon and 500 rounds for each .50-cal. machine gun. The P-61 packs a mighty wallop.

You'd be wise to make a point of helping the armorers until you learn how to load and check the P-61's guns. The life of everyone in the plane depends not only on the crew's ability to shoot well but on the smooth functioning of the guns. Know your guns as intimately as the frontiersman knew his rifle.

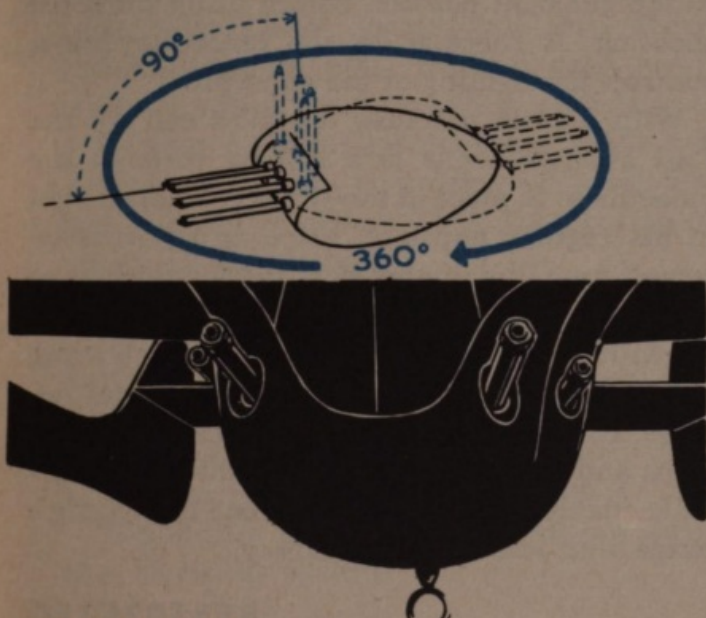

**Pilot's Gunsight**

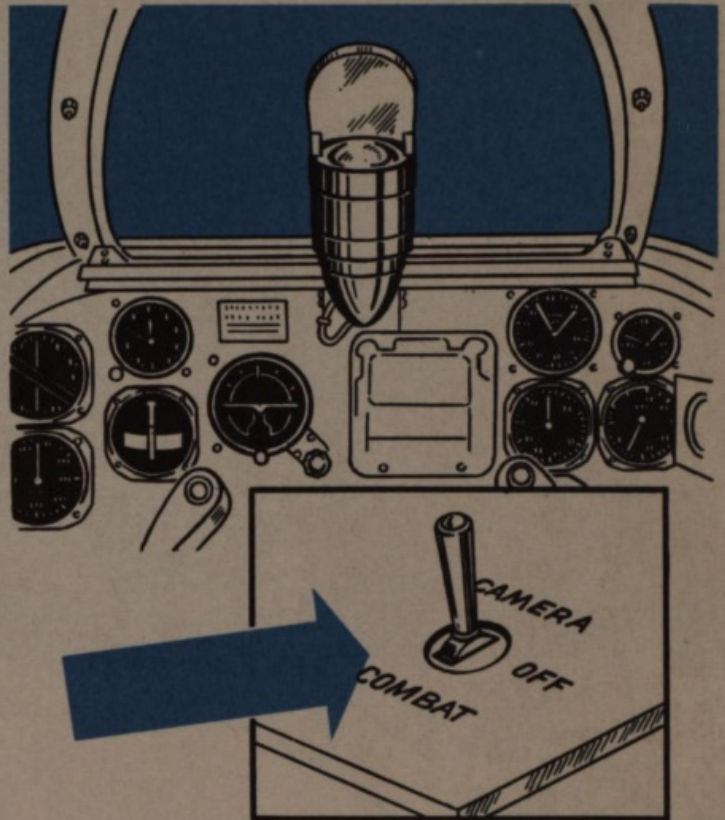

The P-61's pilot has an optical gunsight (100 mil), which is mounted directly in back of his bulletproof windshield and at the top of the instrument panel. With this sight, he aims the fixed guns and directs the fire of the movable guns when they are in the strafing position.

A rheostat on the pilot's electrical panel controls the light in the gunsight. When the rheostat is turned as far to the left as it will go, the light is off. As the rheostat knob is turned to the right, the light comes on and increases.

In some models, a sliding switch built into the bottom of the gunsight turns the light on and off.

Before you fire the guns of the P-61 you practice firing with the gun camera. This is set in the nose of the plane with its lens looking out over the top of the pitot tube mounting. The camera can be adjusted on the ground to continue to take pictures up to 3 seconds after the belly guns have stopped firing.

To operate the camera, first push the toggle switch at the lower right-hand corner of the pilot's electrical panel to CAMERA. The camera then takes pictures when you press the 20-mm. button on your control wheel.

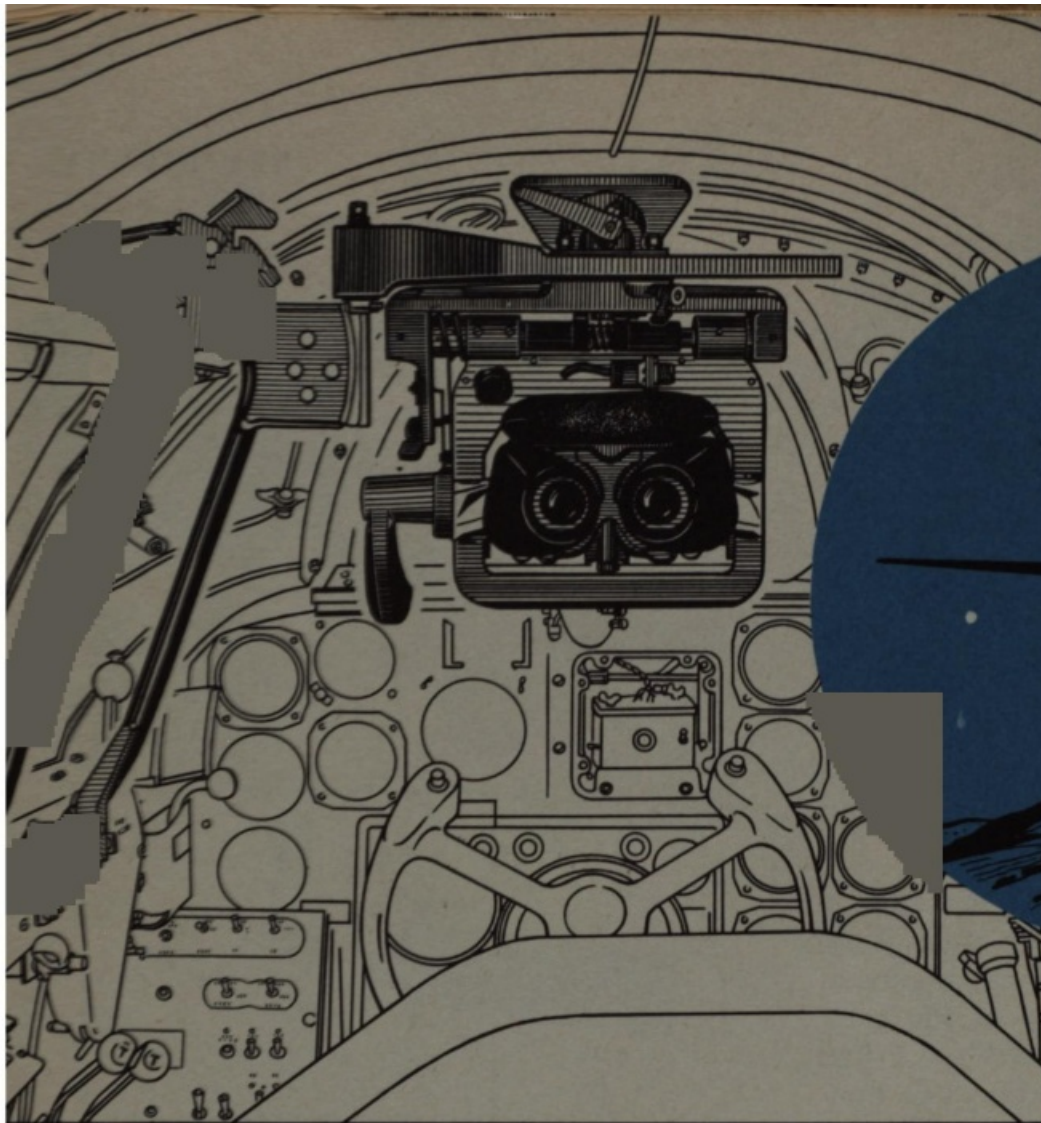

Pilot has to line up dots with wing of enemy plane he's following.

### Night Binoculars

P-61B's have night binoculars for the pilot. With these binoculars, he can see to shoot accurately about four times as far at night as he can without them.

The night binoculars are mounted on a carriage that travels along a track straddling the windows to the left of the pilot's seat. Normally, when not in use, they are stowed behind him, approximately over the front entrance door.

The night binoculars are a combination of 5.8 power night glasses and optical gunsight. They are mounted on gimbals, which prevent all vibration from affecting them, and are set in a frame which swings out from the carriage like a door.

When starting out on a mission in which he expects to use the night binoculars but doesn't need them right away, the pilot usually pulls the binocular carriage forward as far as it will go but leaves the binoculars swung back against the carriage until he needs them.

When he's ready to use the binoculars, the pilot swings them forward and then locks them in position directly in front of him by turning a handle at the top of the frame.

There's a pistol grip at the left side of the binocular frame. With this grip, the pilot can rotate the binoculars from side to side and up and down, for searching. He must return them to the gunsight position before using them for shooting. A rheostat on the binocular frame controls the lighting of the gunsight.

With a little practice, the pilot can fly the P-61 at night while he's looking through the binoculars. In place of the circle and dot of light in his regular gunsight, there is a horizontal row of four illuminated dots in the gunsight of the night binoculars. The pilot lines these dots up with the wing of the plane he is following and uses that combination for an artificial horizon. The inner dots of the gunsight are 10 mils apart and the outer dots are 70 mils apart. This scale enables the pilot to determine the enemy's range with remarkable accuracy.



## EQUIPMENT

There is a 28-volt, 200-ampere generator on each engine of the P-61 and there are two 24-volt, 34-ampere-hour storage batteries. These provide current for all the electrical equipment in the plane. That equipment includes: primers, starters, instruments, lights, the control valve for the ejection chute doors (P-61A), selector valves, gun controls, cannon, gun camera control, fuel pumps, oil dilution system, crew nacelle heater, pitot heater, anti-icers, de-icers, radios, warning bell, landing gear position warning system, and propeller feathering control. There are three control panels in the P-61A (four in the P-61B) containing electrical circuit breakers and switches. They are pictured elsewhere in this manual.

The P-61 has the usual navigation and landing lights. The landing lights are mounted in the bottom of the outer wing panels and swing down and forward when turned on. The plane also carries recognition lights, which can be blinked or kept steady, and taxi lights.





**The master ignition switch does not turn off the electrical system.**

**RESTRICTED**

In the event of emergency, the master battery switch does this.

There is a place on the outer side of the left engine nacelle for plugging in an external battery cart. Whenever one of these carts is available, use it for starting the plane's engines rather than drawing down your own batteries. However, be sure to turn OFF the master battery switch in the plane before plugging in a battery cart.



- LEGEND**
-  PRESSURE
  -  RETURN
  -  SUCTION
  -  SELECTOR VALVE TO UNIT

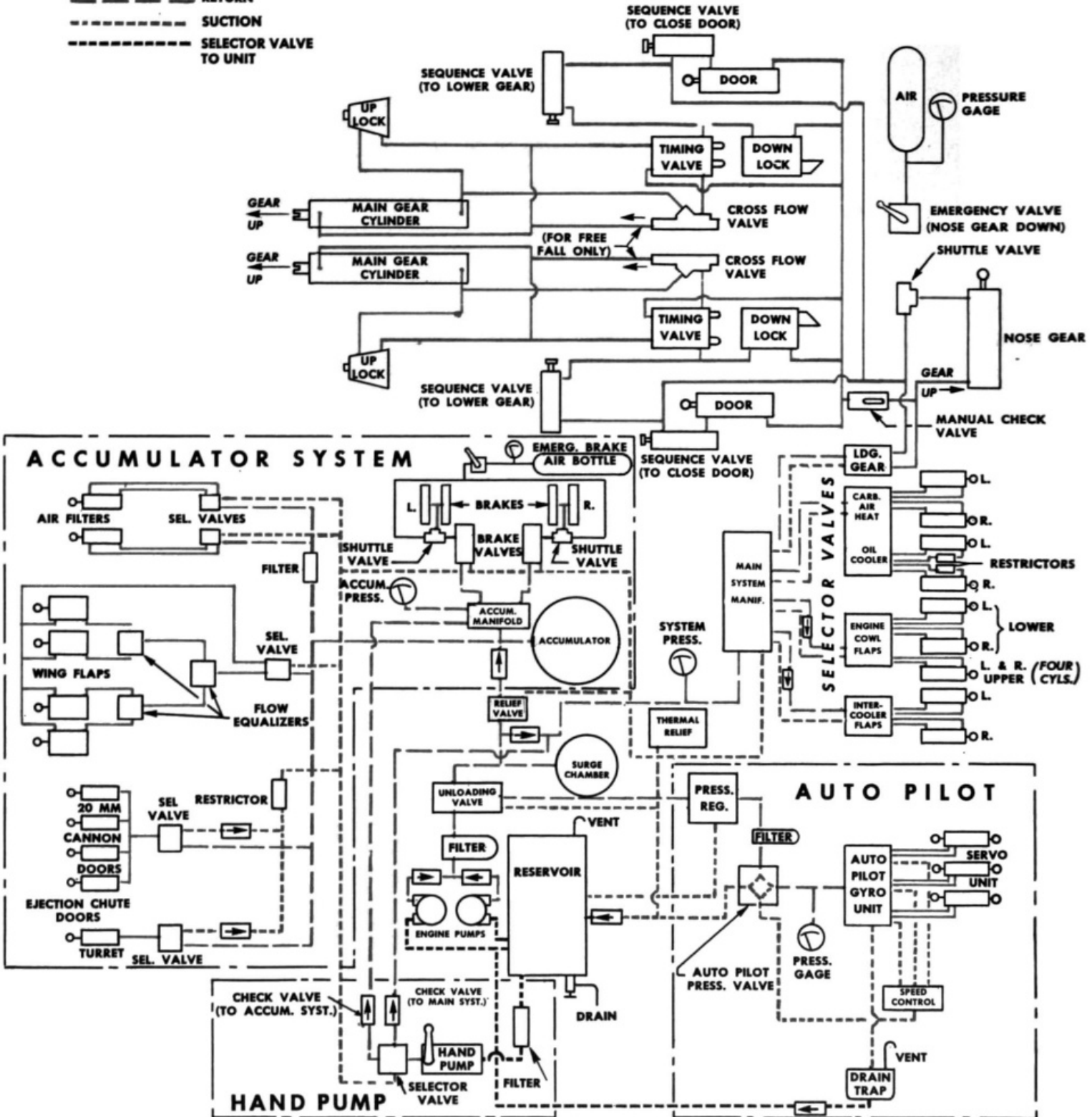

**HYDRAULIC SYSTEM**



### Hydraulic System

The hydraulic system of the P-61, supplied with fluid from tanks located in the compartment behind the gunner's seat, operates the following equipment: landing gear, brakes, main gear latches and wheel doors (P-61A), engine cowl flaps, carburetor air heat valves, inter-cooler exit flaps, carburetor air filters, oil cooler flaps, wing flaps, ejection chute doors (P-61A), and the automatic pilot.

A pump on each engine supplies pressure for the hydraulic system. The fluid from both pumps converges and flows through a filter to a valve which maintains 850-1000 psi pressure in the main and accumulator systems. This valve also supplies fluid to the automatic pilot through a pressure regulator.

The hydraulic system has four parts: main system, accumulator system, emergency system, and automatic pilot. One engine-driven pump can provide pressure for the entire hydraulic system of the plane, but operation of the landing gear and wing flaps is much slower in this case. If both engine-driven pumps fail, you can still operate the hydraulic system by means of a hand pump at your right knee.

The proper emergency procedures to follow, in case of damage to or failure of the hydraulic system, are described in the chapter on Emergency Operations.

### Landing Gear and Warning Horn

The landing gear control lever is just forward of your left knee. When you are slowing down to lower the landing gear, **make sure the landing gear warning horn blows when the throttles are pulled back.** After the gear is lowered and locked, retard the throttles momentarily again to make sure the warning horn **does not blow.**

(Naturally, when you retard your throttles to make a test glide, with wheels up, the landing gear warning horn is going to blow. You may silence it temporarily by pushing back the switch above the propeller electrical control panel. The switch automatically re-sets itself for normal operation when you open the throttles again.)

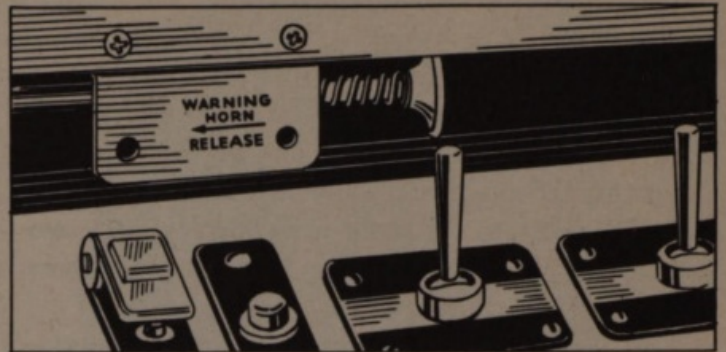

In addition to checking on the operation of the landing gear warning horn when you are about to land, also look at your landing gear indicator on the instrument panel. It should show that the wheels are down. In the daytime, take the added precaution of glancing out the window to check the position of each main wheel. Then, look at the front portion of either engine cowl. If these engine cowls are kept clean and shiny, they're as good as mirrors for telling you the position of the nosewheel.

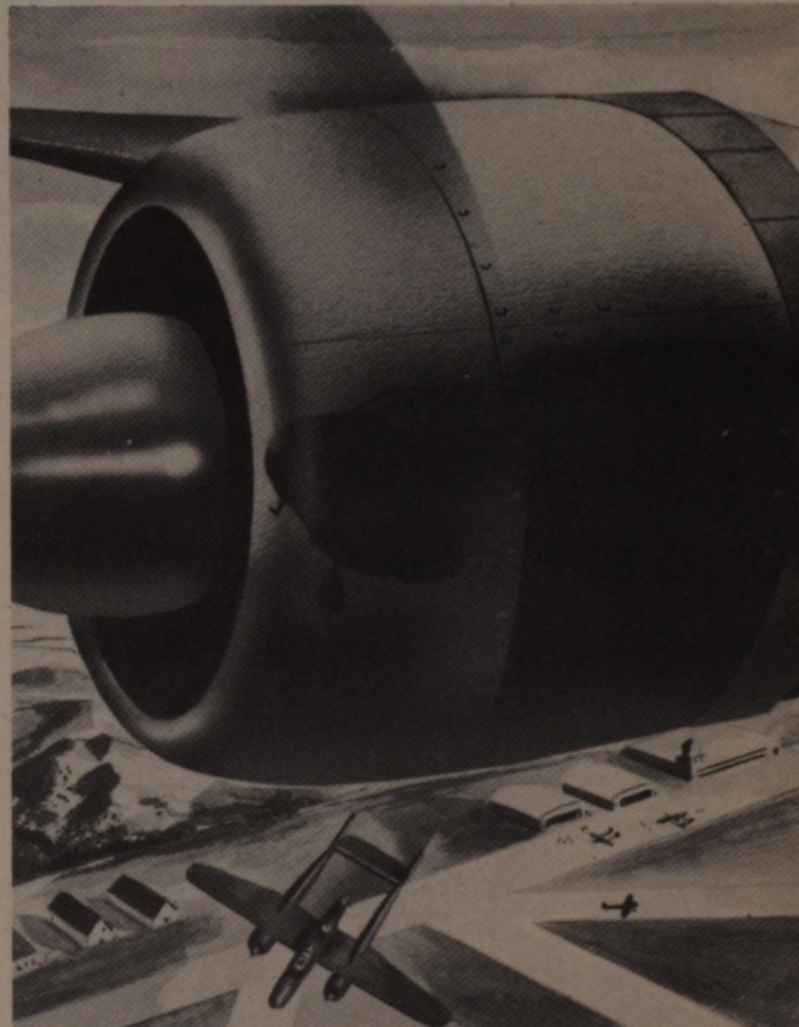

**Wing Flaps**

The position of the airplane's wing flaps is controlled by a lever mounted on the side rail over the throttle quadrant. The flaps lower 60° from the UP position. They also lock firmly in the UP position. If they are not locked, two lights just forward of the flap control lever warn you of that fact.

You must move the flap control lever two-thirds of the way from NEUTRAL to DOWN to release the flap locks mechanically. As it moves through the last one-third of its arc, the lever releases the hydraulic pressure which moves the flaps.

The flap control lever usually works stiffly in the first two-thirds of its arc. Be prepared for this. One pilot, finding the lever so hard to push that he thought something had gone wrong with the control, unnecessarily made a no-flaps landing.

The proper procedure to follow in case the main hydraulic system isn't working is described in Emergency Operations.

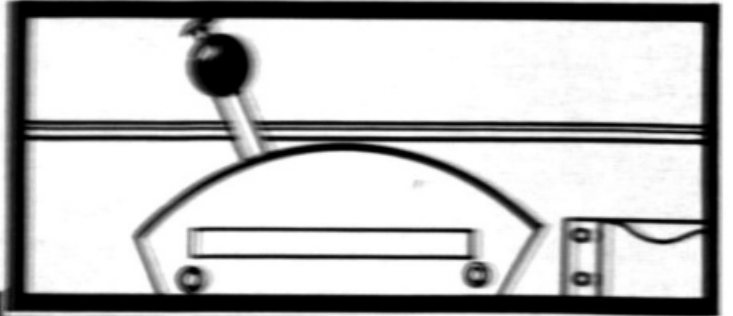

**Heating and Ventilating System**

At the right of every crew member in the P-61, though generally well hidden on the nacelle wall among wires, tubes, levers, and control boxes, is a ventilator. It operates manually. By manipulating a lever on the inside of the plane, you can push a scoop into the slip-stream outside and get all the air you want. In addition, if conditions justify it, the pilot and gunner can open side windows in their forward compartment.

P-61A's have four small gasoline heaters. The P-61B has only two such heaters but, fortunately, they are large and adequate. The heaters supply heat for the windshield defroster, 20-mm. cannon breech blocks and, incidentally, the crew members. **Don't use the heaters until the plane is in flight.** The engine manifold pressure must exceed the outside atmospheric pressure by 2" before the heaters work.

### Radio

The P-61 carries an exceptionally large amount of radio equipment, both for communication and interception purposes. We cannot describe the radar equipment in this manual. The pilot's chief concern, anyway, is with the communication equipment and that is adequately described on Pages 83-86.

There are T-30 throat microphones and HS-33 earphones at all crew positions. Carefully stow this equipment in a convenient corner of the plane and use your A-11 helmet headset and the A-14 oxygen mask with the installed T-42 microphone. The helmet earphones keep out noise much more effectively and are a great deal more comfortable than the headband earphones. The oxygen mask microphones are considerably clearer and more comfortable than the throat microphones. You have to use oxygen from the ground up on all night missions, anyway, and **you must be able to understand every whisper from your RO.**

### Oxygen

P-61's carry low pressure, demand-type oxygen systems, one for each crew member. The outlet is located along the rail at the right of each man. All you have to do is plug your mask into the tube and breathe.

The oxygen regulator has a lever which reads AUTO MIX ON and OFF. When the auto mix



is OFF, the regulator supplies pure oxygen. With the auto mix ON, it blends the proper amount of oxygen with the normal air at whatever altitude you are flying.

The red EMERGENCY knob on each oxygen regulator may be opened to provide a steady flow of additional oxygen instantly in case you feel slightly dizzy. However, don't use this emergency source any longer than you have to, for it will use up your entire supply of oxygen in a hurry if left on. If the demand regulator mechanism fails, you must also use the EMERGENCY knob to supply yourself with the necessary oxygen.

There is a flow indicator (blinker) that shows you when oxygen is flowing from the tanks to be mixed with the air you're breathing. An amber light located between the blinker and the pressure gage for the oxygen system warns you when the pressure is dangerously low.

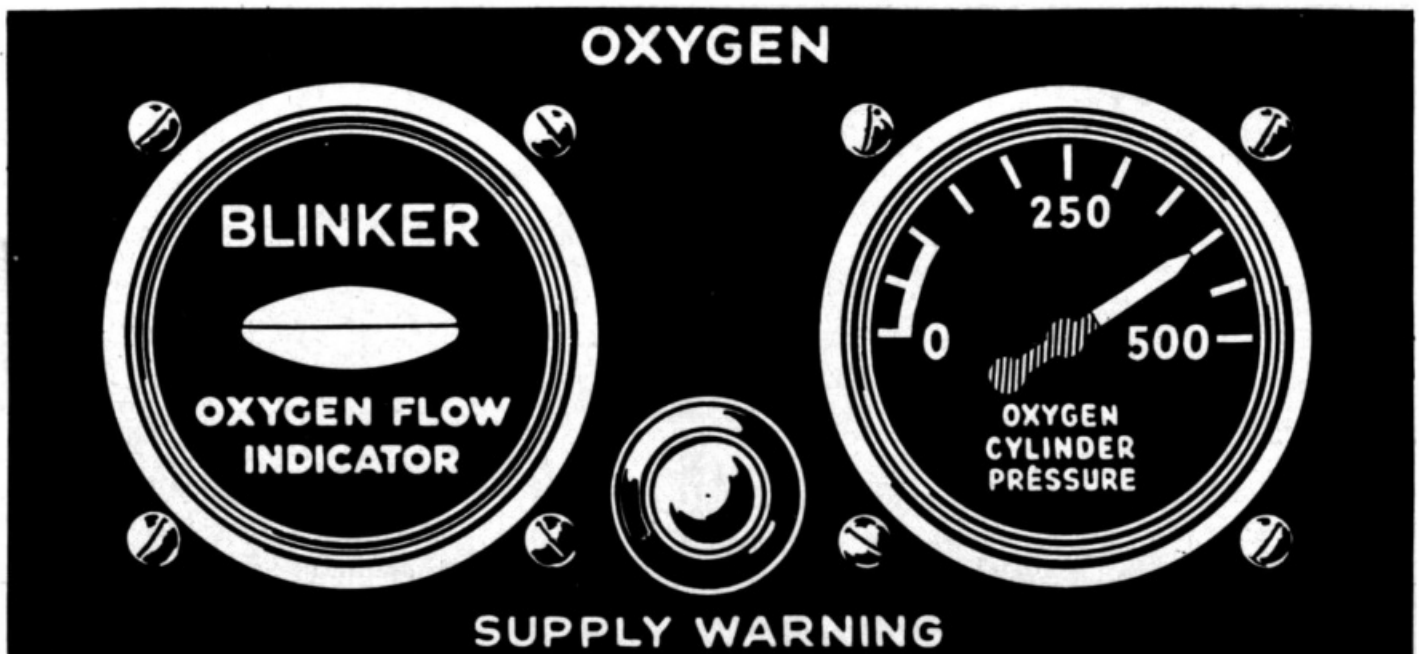

**Automatic Pilot**

Generally, on cross country missions the pilot makes good use of George, the automatic pilot. He is a great help in keeping you on a straight and level course while you read maps or use your E-6B computer.

The automatic pilot operates hydraulically. When you want to use it, first be sure that both gyro instruments which control it are uncaged. Then, turn ON the AUTOMATIC PILOT OIL PRESSURE. Trim the ship to fly hands off. Next, by means of the little knobs at the top of the automatic pilot panel, line up the pointers which indicate the relative positions of rudder, aileron, and elevator controls. If these pointers are not lined up properly, you may

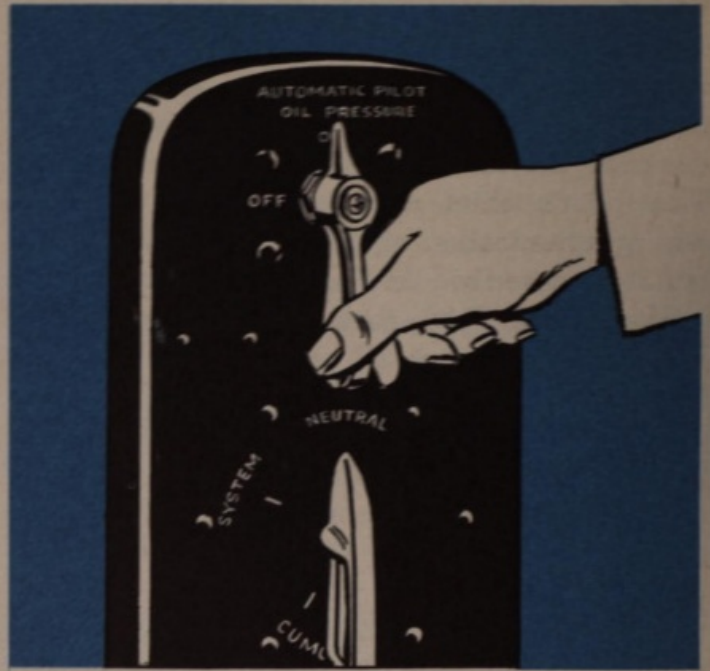

Turn aileron knob to aline vertical markings; turn elevator knob to aline horizontal markings on dial.

Turn this knob to left or right to aline top row of figures on dial of directional gyro with bottom row.

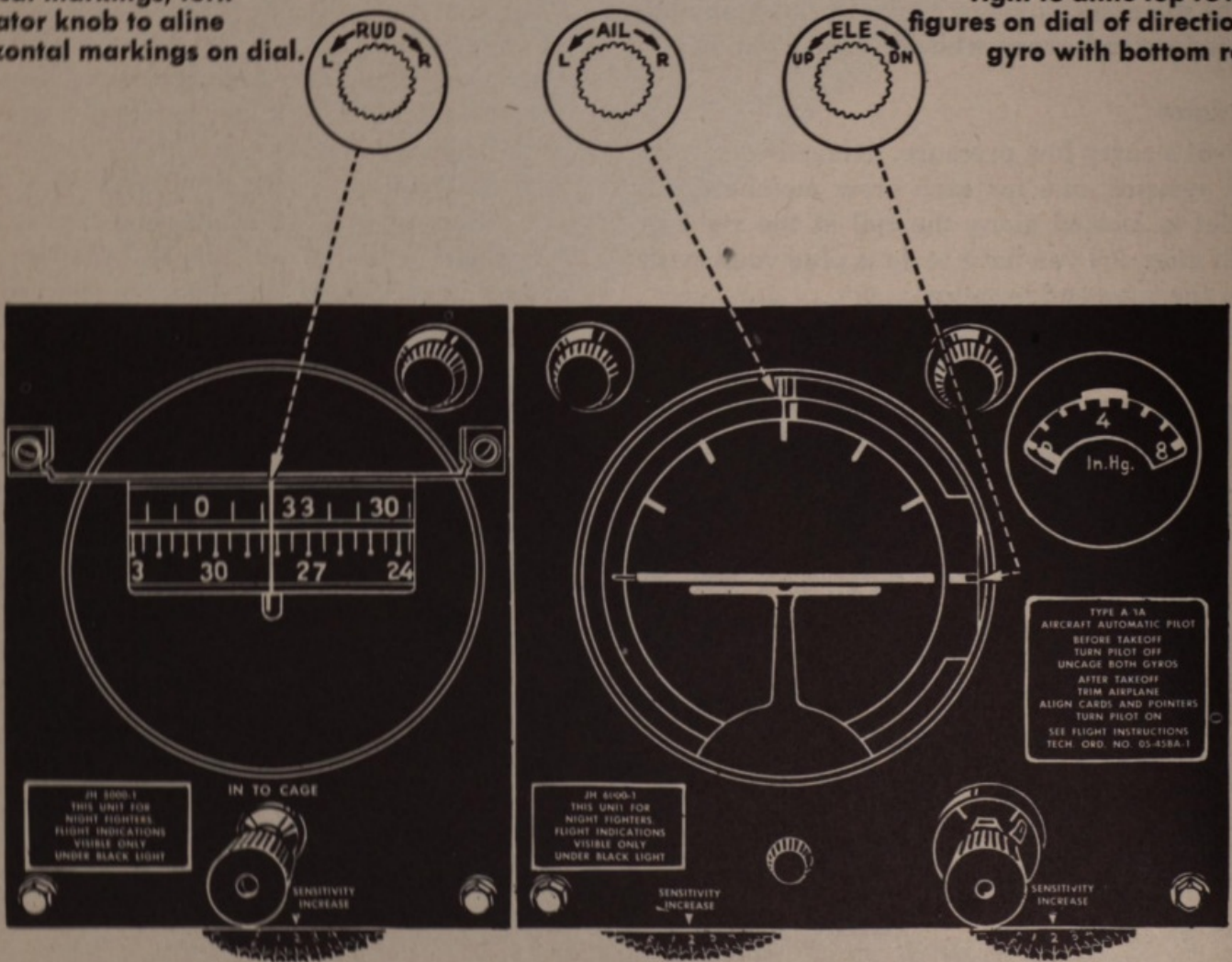

fly off in a totally unexpected direction when you engage the automatic pilot.

Regulate the speed control valves as desired. These determine how fast the automatic pilot



corrects the attitude of the plane in flight. A good setting for the speed control valves is 2 in smooth air.

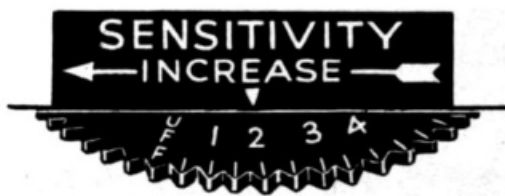

When you have completed these necessary preparations, you are ready to engage the automatic pilot by means of the lever in the floor at the right side of your seat.

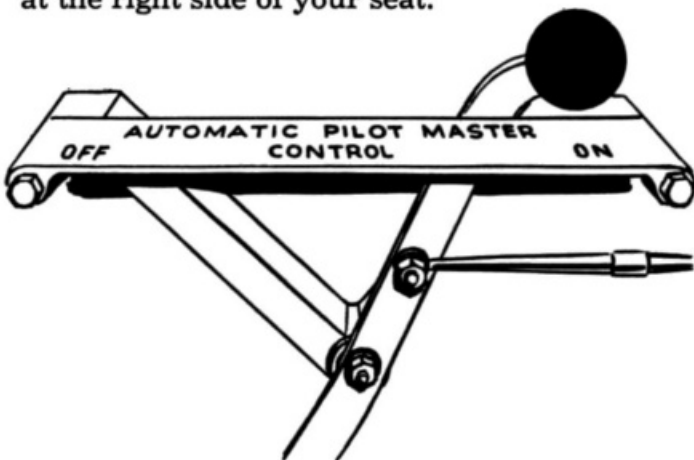

The automatic pilot oil pressure gage should read 100-125 psi for normal operation. Sometimes, it will read low before you engage the automatic pilot. Generally, however, it promptly registers a normal reading after the automatic pilot is engaged. If it does not, disengage the automatic pilot and enter your unhappy discovery on the Form 1.



The automatic pilot's suction gage should read between 3.75" and 4.25" Hg. at all times.

Never use the automatic pilot to control the airplane in extremely turbulent air, when wing de-icers are operating, when either engine is not running properly, or when the plane is flying at less than 140 mph indicated airspeed (IAS).





### Pyrotechnical Equipment

Every P-61 carries an M-8 Very pistol, signal cartridges, and parachute flares. They are in the gunner's compartment in a container fastened to the bulkhead behind and above his seat. In each plane there are also two small smoke grenades. One is kept in the RO's compartment; the other is in a rack in the gunner's office.

The signal cartridges and parachute flares are frequently used for normal identification purposes in tactical areas at night, as well as to guide rescuers to the site of a forced landing.

### Fire Extinguishers

There are three fire extinguishers in the P-61. There are two quart-size carbon tetrachloride extinguishers, one in each main landing gear wheel well. The third one, a two-pound CO<sub>2</sub> extinguisher, is in a holder on the bulkhead behind the gunner's seat.

### First-Aid Kits

The plane carries two first-aid kits. One of them is on the forward side of the gunner's armor plate. The other is on the wall of the crew nacelle to the left and aft of the rear entrance hatch.

### Miscellaneous Equipment

Polaroid night adaptation goggles are furnished for each crew member of the P-61. A standard airplane emergency kit and four Type D-1 mooring kits are carried in the wheel wells of each plane.

There is a data case for the RO and a map case in the flight control report holder in the pilot's compartment.

### Seats

In the P-61A, the pilot's seat can be raised, lowered, and moved left or right. It is also possible to tilt the bottom of the seat without changing the angle of the back. And the back is hinged so that the pilot can get in and out of his seat more easily. In the P-61B, the pilot's seat cannot be moved sideways. Otherwise, it is the same.

Each seat in the plane has a standard safety belt and a shoulder harness. **Be sure to wear the shoulder harness.** Even if you weren't required to wear it, by AAF Reg. 62-18, it would still be an important safety precaution. The gunner and RO each have a seat which includes a remote control gun turret sighting station.

There is a relief tube near each seat in the plane.

### Escape Hatches

There are three escape hatches in the P-61. The top of the pilot's compartment opens to the left when the latch above his right shoulder is released. Normally, he opens this hatch to climb over the back of his seat every time he enters and leaves the plane.

The right side of the gunner's compartment may be unlatched and pushed out completely. This hatch should never be used except in an

emergency. Neither should the RO's escape hatch. In the early A models, the plexiglas panel over the RO's head opens in the middle and folds outward to left and right. In later A's and in the B model, only the port half of this panel opens. It opens out and down.

The chapter on Emergency Operations, Pages 96-105, tells you and your crew when and how to use the escape hatches. It also tells you when to resort to the entrance hatches in bailing out, and how to leave the plane through them when that becomes necessary.

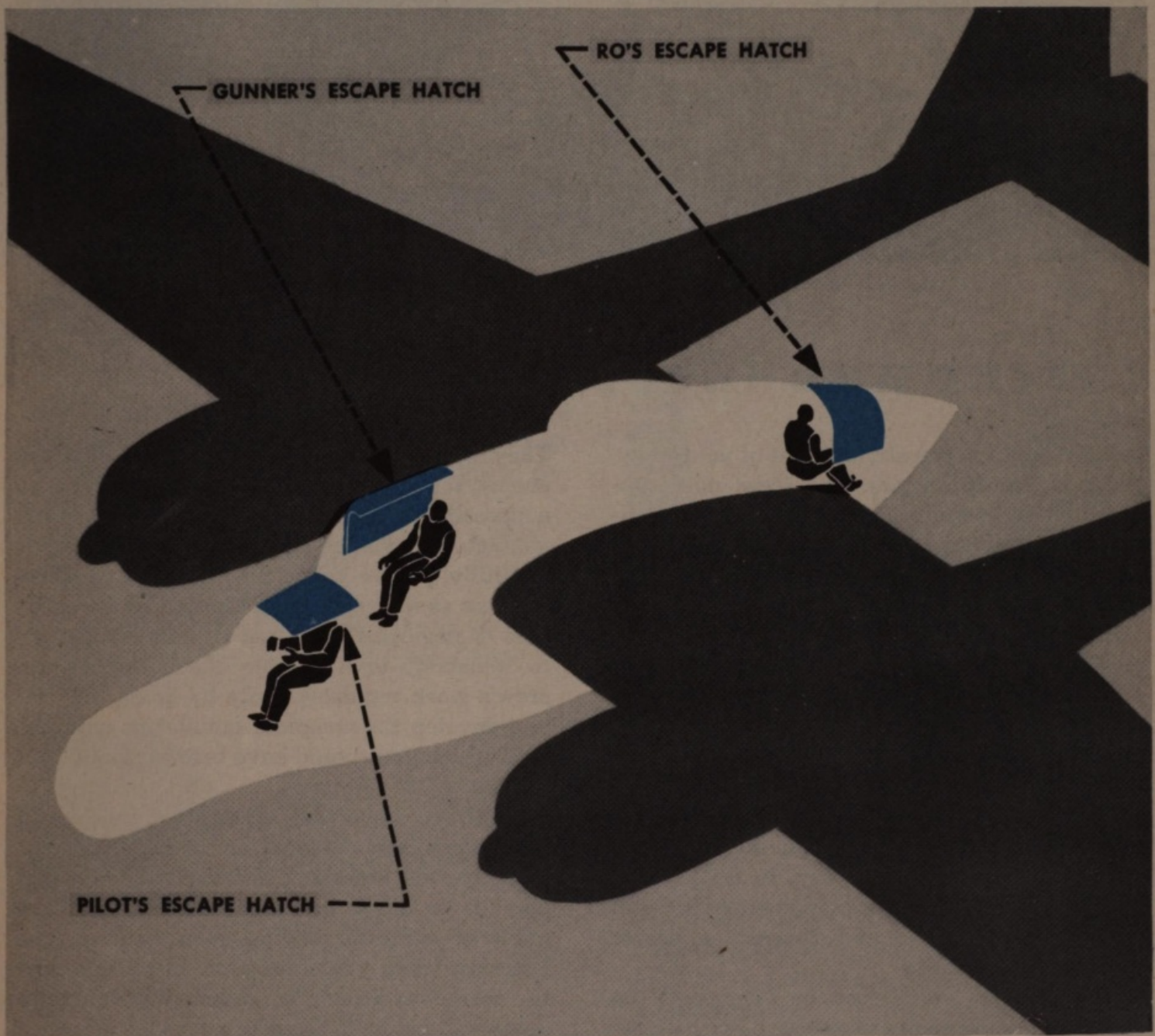

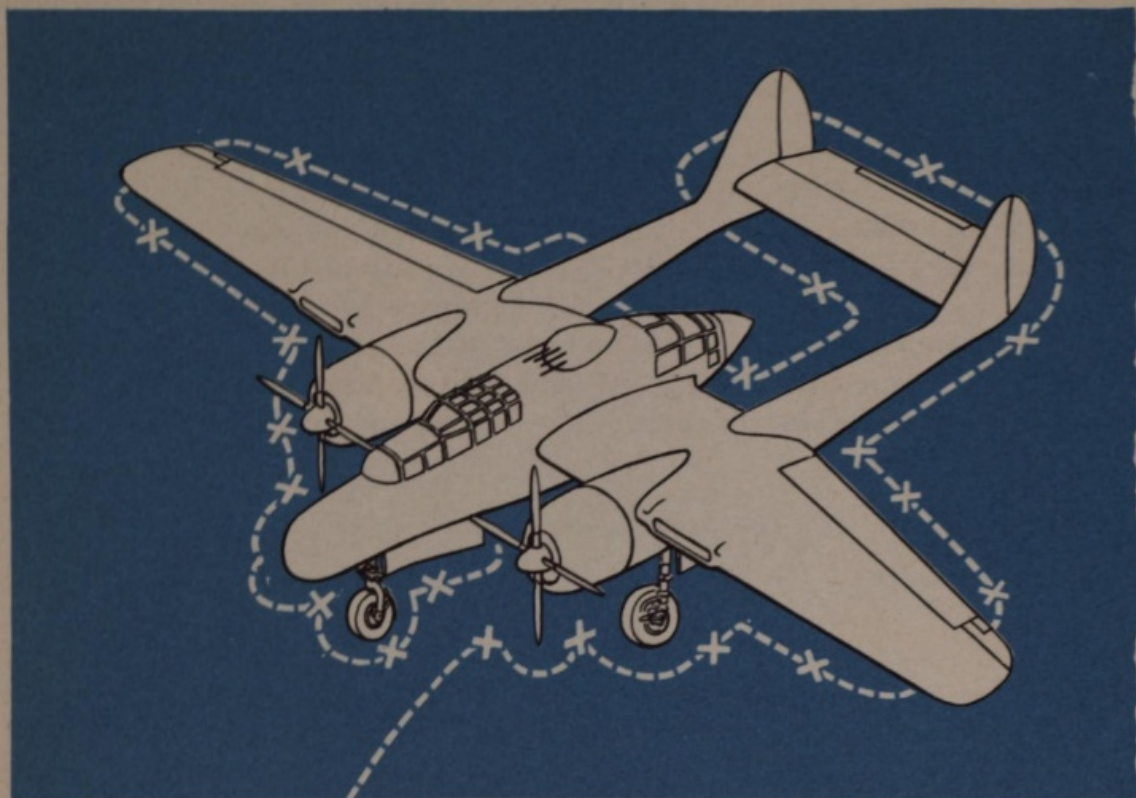

## CHECKS AND INSPECTIONS

Your safety in the air, and that of your crew, depends mainly on you. The crew chief supposedly has carefully checked the plane's condition before you are ready to fly it. But don't rely on him entirely. He may forget. **You can't afford to forget.**

Somewhere, sometime, in a tactical area, you may have to be crew chief, ground crew, and pilot all rolled into one. It may be your responsibility to find out whether your plane is in proper shape to fly and, if not, to put it in shape to fly. To prepare for that day, which has come to many a pilot in combat theaters, find out what the crew chief and his men do when they go over your plane every day. In fact, it's an excellent idea to watch or help them go through a preflight check and daily inspection before you first fly the P-61.

This airplane you'll soon be flying cost the folks back home plenty of dough. They had one purpose in mind—and one purpose only—when they bought the war bonds which paid for it.

They were buying a weapon to help beat the enemy. It was put in your hands because you're supposedly the guy who can use it to best advantage. But you've got to do more than fly it skillfully; you've got to see to it that its effectiveness as a weapon isn't blunted by carelessness or neglect. Don't trust its care completely to somebody else. Double check the ground crew's work regularly. Only by doing this can you develop the complete familiarity with the P-61 which you should have before you fly it in combat.

Until you have that intimate knowledge of your plane, the practical and sensible way to make certain you don't overlook an important point is to use a thorough checklist. Make a habit of carefully testing each item on the checklist when you come to it. In a short time the correct order and condition of your equipment will be so familiar to you that anything out of order or adjustment will stick out like a sore thumb.



## VISUAL INSPECTION — Outside the Airplane



When you first approach your P-61, before you enter the cockpit, walk around and inspect the airplane from front to rear, starting at the left wing.

Your inspection should cover these points:

- **Wheel Chocks:** In place?
- Pitot Tube:** Uncovered?
- Nosewheel Lock Pin:** Is the red cap on tight?
- Tires:** Any signs of defects? Leaks? Low deflation? Slippage on rim?

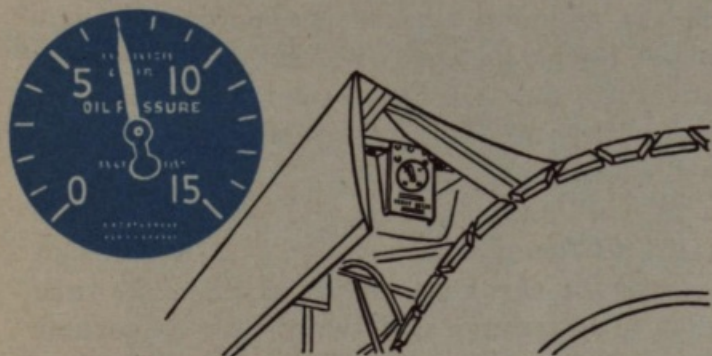

**Wheels:** Any cracks? Distortions? Is the nosewheel hub cap secure?

**Hydraulic and Brake Lines:** Any leaks? Loose fittings?

**Struts:** Is each strut extended about 4 inches? If so, you have proper inflation.

**Bungee Pressures:** Look at the gages in the wheel wells. Do they indicate 750 psi on each of the main wheels? 700 psi on nosewheel? These bungee air bottles help lower the plane's landing gear, especially if the hydraulic system fails.

**Propellers:** Before you touch them, look in the cockpit to **make certain all ignition switches are OFF**. Now, are there any pits, cracks, or nicks on the blades? Are the hubs and attached parts secure and free from obvious defects?

**Engines:** Excessive dirt in cooling fins? Have any rags or wrenches been left behind?



**Cowlings:** Properly installed and fastened?

**Leading Edges:** Inspect top and bottom sides of all lift and control surfaces.

**De-icer Boots:** Are they fastened securely? Are there any rips? Oil or gasoline spots?

**Control Surfaces and Hinges:** Visible defects? Excessive looseness?

**Inspection Plates: Secure?**

**RO's Upper Escape Hatch:** Is it positively locked? If not, it will blow away during take-off. After checking the hatch, be sure to close the compartment door when you leave.

**Gun Bay Doors:** Securely locked? Test with the wrench you find inside the door of the 20-mm. ammunition compartment. You feel and hear two distinct clicks when you lock each end of the gun bay doors.



There are four more important items to check in order to make your visual outside inspection of the airplane complete. To inspect the first two, stand on the ladder leading into the pilot's compartment. To inspect the others, you must climb up through the cockpit, unlatch and open the pilot's hatch, and go out on the top of the plane. Don't step on the plexiglas over the gunner's compartment. Walk on the metal ribs and warn the servicing crew to do so.

The last four check points of your visual inspection of the airplane are:

**Gunner's Escape Hatch:** Are the locking pins securely in place? Look at both of them.

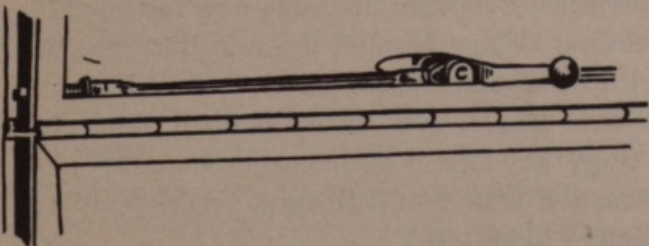

**Gun Turret Power Switches: Are they OFF?**

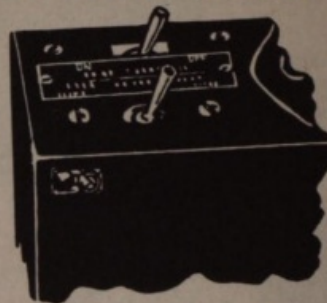

**Gun Turret Fairing:** Is it latched? Are the solenoid doors closed? Take hold of the guns and try to move them. They should be firmly fixed in the forward position.



**Fuel and Oil Tank Caps:** Are they firmly in place?

**Don't try to climb into a P-61 with your parachute on.** Have the crew chief make a practice of placing it in the airplane before you enter.

The vital, visual, outside inspection of your P-61 won't require a lot of time. You can check many items, such as the landing gear, wheel chocks, and pitot tube, as you approach the airplane. Keep your eyes open. If the landing gear struts appear low, for example, or a cowling looks loose, get the crew chief on the job and make a further inspection.

In addition, when you and your crew have come to function as a team, you will assign part of the checking routine to them. **Be sure they are thorough and realize how important this duty is.**

**Remember that it is your important responsibility not to fly that plane until you are thoroughly satisfied that it is in proper condition.**

## CHECK WITH THE CREW CHIEF



Make a point of talking things over with the crew chief. Ask him about any recent repairs, any additions to or changes in equipment. Question him about the general status of the airplane, and anything that may have been reported from the previous flight. Friendly contact with the crew chief serves a double purpose. You not only pick up a lot of useful information, but you also stimulate the crew chief's interest in the airplane and heighten the ground crew's morale.

### When You First Enter the Cockpit

After you have checked the fuel and oil tank caps, return to the cockpit. Before you take your

seat, however, turn on all circuit breakers on the panel in the compartment behind the gunner's seat. One of these, the circuit breaker which controls the position lights, is not necessary in the daytime. Turn it on, anyway. Your flight may last beyond dusk, and once you are piloting the plane you can't reach that switch.

Next, take your seat and check Form 1A.

### Form 1A

Always know the STATUS TODAY of the airplane before you fly. When ground crew members place a red symbol under this heading they are doing it to safeguard your flight. It's then up to you to determine the nature of the trouble and govern your flight accordingly.

The Form 1A clearly states the meaning of the red diagonal. Be sure you understand the exact nature of the minor defect which it indicates before you fly.

You must understand and release the red diagonal before you can take off.

Pay particular attention to the airplane and engine time, the time that must elapse before the next inspection. Read any notes that the previous pilot and crew chief have entered. Notice the quantities of fuel and oil, and the amounts serviced. You will shortly check these against your gages.

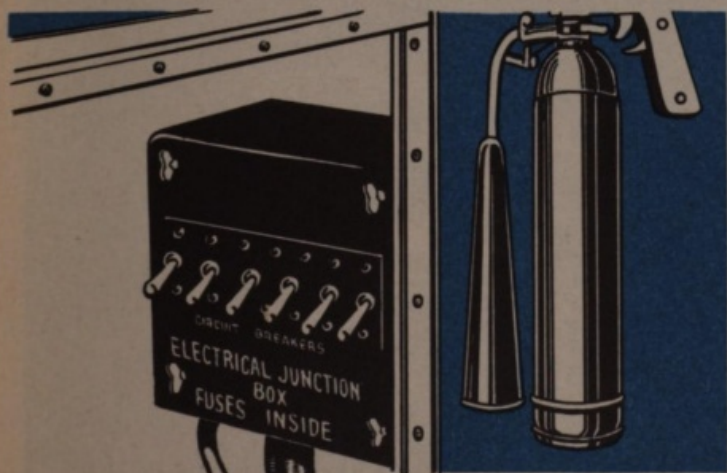

## RESTRICTED

Check the status of your communication and radar equipment.

When you have finished checking the Form 1A, fasten on your parachute. Then adjust the safety belt and shoulder harness. Fasten your safety belt before you regulate the height of the seat. You may have to raise it, and you'll find it easier to do if your safety belt is already in proper adjustment. Finally, adjust your rudder pedals properly.

### Cockpit Check

**Know your cockpit thoroughly.** It takes at least three hours of concentrated study, and you must pass a blindfold check before you are permitted to take up a P-61, even in the daytime. Remember, you will do most of your flying in this plane at night, and on instruments. Therefore, you must know **by touch** how your controls are set.

At the start of the cockpit check, first look at your windshields. How clean are they? They must be spotless. Moisture collects on a dirty or greasy surface much faster than it does on a clean one. A dirty windshield clouds up more quickly when you are descending from high altitudes. It also reflects any stray light that is present, and can cut down your vision as much as 50%.

Make sure the crew chief has closed both the entrance door to your compartment and the entrance door to the RO's compartment.

Look over your left shoulder to make certain the fire extinguisher is latched in place behind the gunner's seat.

Look around the cockpit. Is it clean? Is there anything lying around which might shift in flight and foul the controls?

Now, turn on all circuit breakers and switches on your generator control panel, except those for the heater and cannon relay. If you hear any large electric motors running, check both radar and gun turret switches to see which is ON. Turn it OFF.

Next, look at your instruments:

1. Are there any loose or broken cover glasses?
2. Does your wheel indicator show that the wheels are down and the flaps up?

3. Does the fuel gage agree with the entry on Form 1A? All tanks should be full.

4. Does the oil cooler shutter indicator show the shutters are  $\frac{1}{4}$  to  $\frac{1}{3}$  open, as they should be?

5. Has the clock been wound and set to Operations Office time?

6. Is your altimeter set to field elevation?

7. Do the oil pressure gage, fuel pressure gage, and the tachometer read zero?

8. Does your manifold pressure gage read approximately 30?

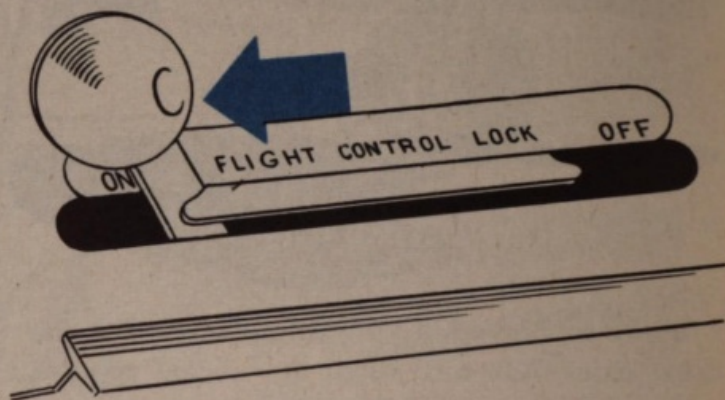

9. Are the oxygen tanks full (showing 425 psi pressure)?

10. Is the emergency air brake pressure correct (425-450 psi)?

Now, release the surface control lock. Until you do this, you can't open the throttles.

Set the parking brakes.

### Pre-Starting Check

You are now ready to make your pre-starting check. When you do this, **always inspect the cockpit all the way around from left to right.**

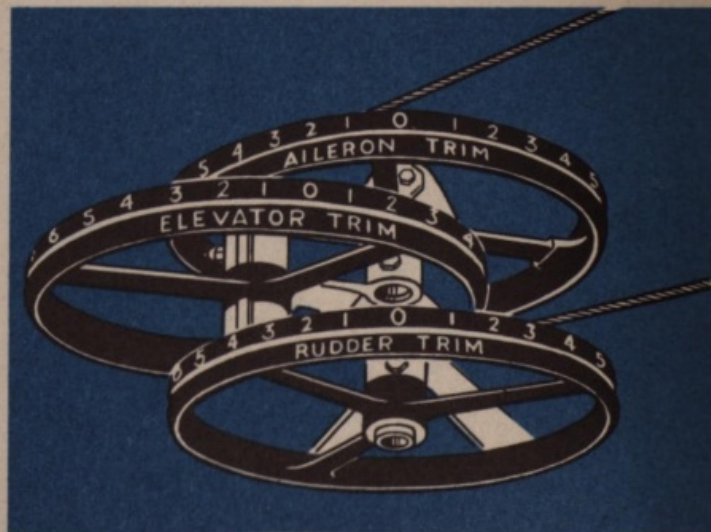

1. Set all trim tabs at neutral. To do this, move the 0 of each trim tab wheel into the line of vision between your eyes and the shaft on which the wheel is mounted.

2. Set fuel selector valves to the outboard tanks, with the crossfeed valve OFF. Be sure you have turned the valves to the tank you want to use.

5. Place throttles approximately 1/3 open. Set mixture controls at IDLE CUT-OFF. Move propeller control levers all the way forward.

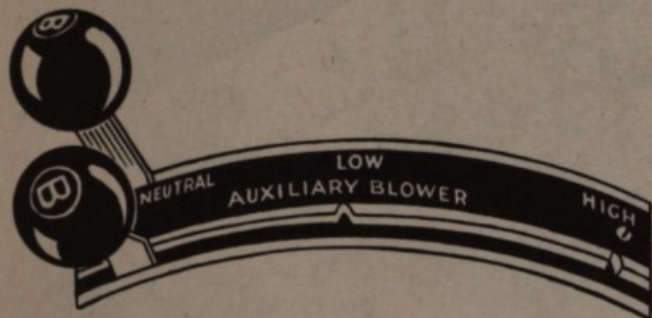

3. Blowers must be in the NEUTRAL position.

4. Check propeller electrical controls. Feather switches must be in the NORMAL position. Push both circuit breakers down. Selector switches must be in the CONSTANT SPEED position. Always keep them in this position, except in an emergency.

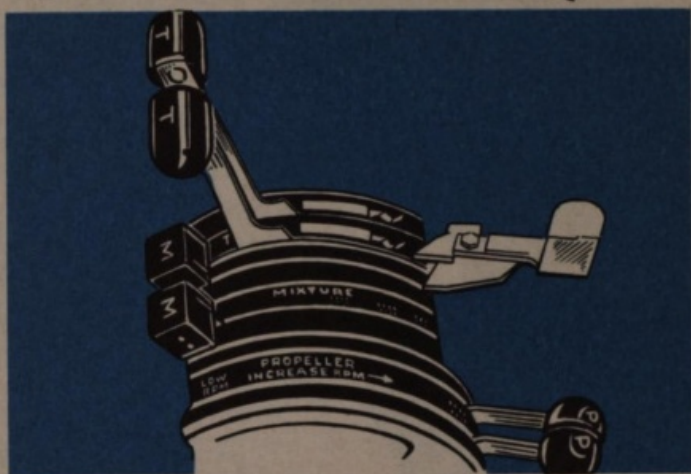
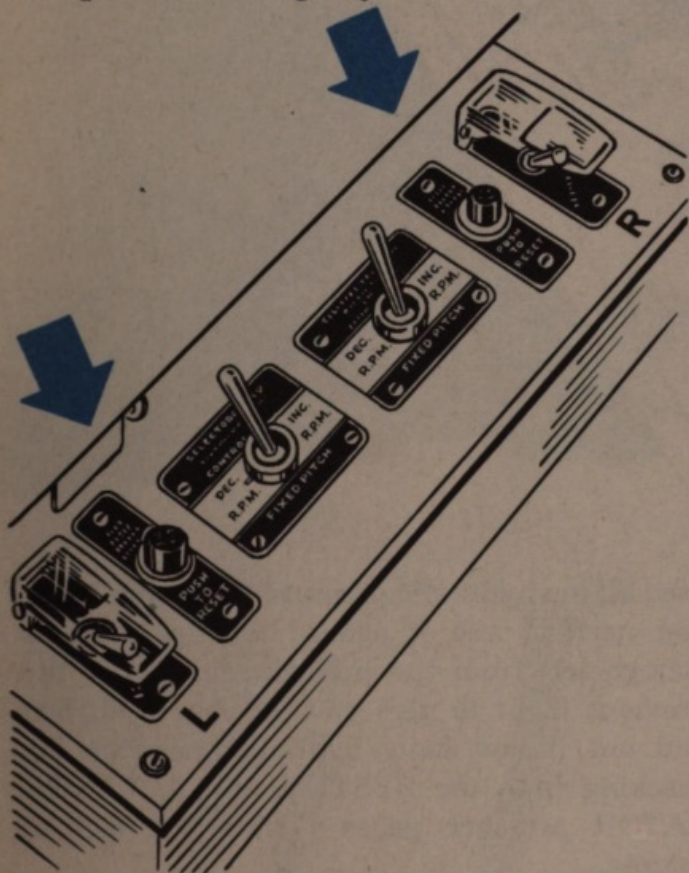

6. Are your flaps up? If not, put them up as soon as the engines are running.

**RESTRICTED**

7. Look at your electrical control panel. See that all switches are in the proper position: batteries ON, oil dilution OFF, fuel booster pumps on LOW, pitot heater OFF, position and landing lights OFF, camera OFF.



8. Check the position of the landing gear handle. Make sure that it is latched down firmly.

9. Turn your carburetor air heat controls to OFF and leave them there for a few seconds. Then, return them to LOCKED position.

In setting the parking brakes, before you began your pre-starting check, you may have

used all the hydraulic pressure there was. Now, you need to use it again. Usually, there is enough left from the preflight run-up or the previous flight to give you all you need. But find out if you have hydraulic pressure by checking both the SYSTEM and ACCUMULATOR pressure gages behind the control column.

If these pressure gages register zero, follow this procedure:

Turn your hand pump selector valve to SYSTEM and operate your cowl flaps, intercooler flaps, oil cooler shutters, and carburetor tem-



perature controls by pumping.

Then, switch your hand pump selector valve to ACCUMULATOR and set your parking brakes by pumping. The wing flaps also operate from the accumulator system, but it takes two minutes of pumping to raise or lower them by hand. If, for any reason, the wing flaps are down when you are making your pre-starting check of the airplane, wait until the engines are running before you put the flaps up.

10. Open all cowl flaps and return the levers to the LOCKED position.

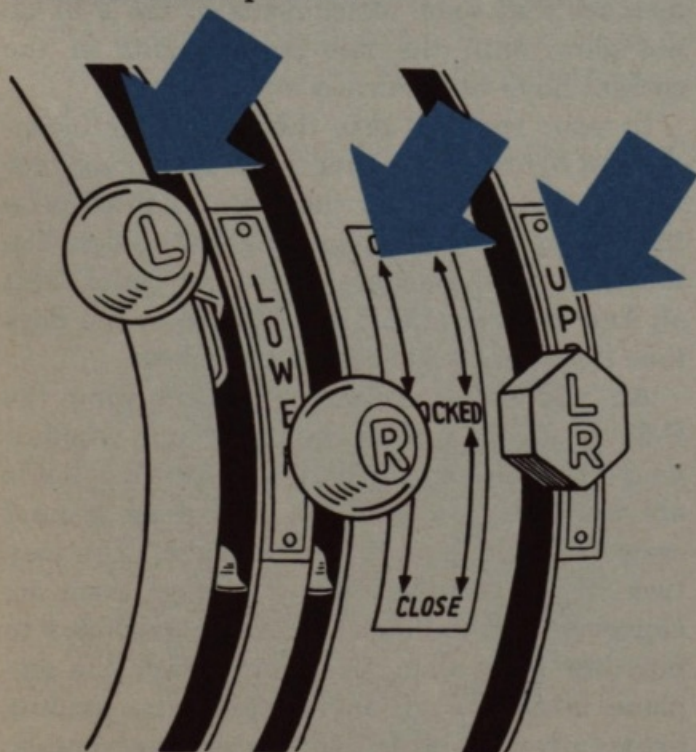

11. Close intercooler flaps and return handles to LOCKED position.

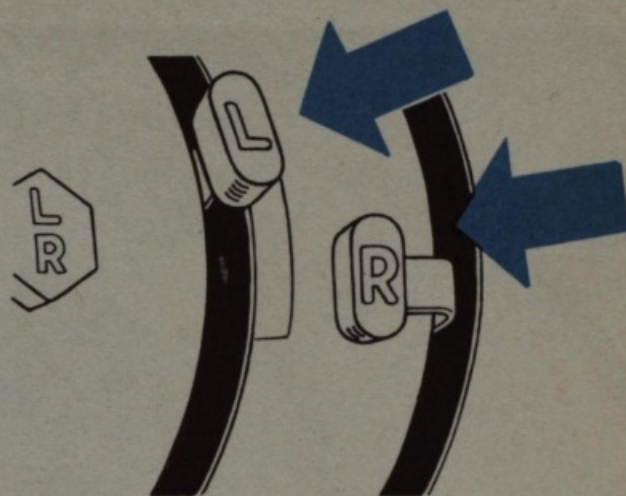

12. Be sure the oil pressure for your automatic pilot is OFF, and that the automatic pilot itself is not engaged.

13. Check both VHF radio switches to make sure they are OFF.

14. Make sure that your identification light switches are in the OFF position.

Just before starting the engines, look to see whether the canopy of your compartment is closed, as it must be. Then, if dust is blowing across the field, turn on your carburetor air intake filter. Hold the switch in the ON position for a few seconds, and release. This changes the flapper valves in the induction system and

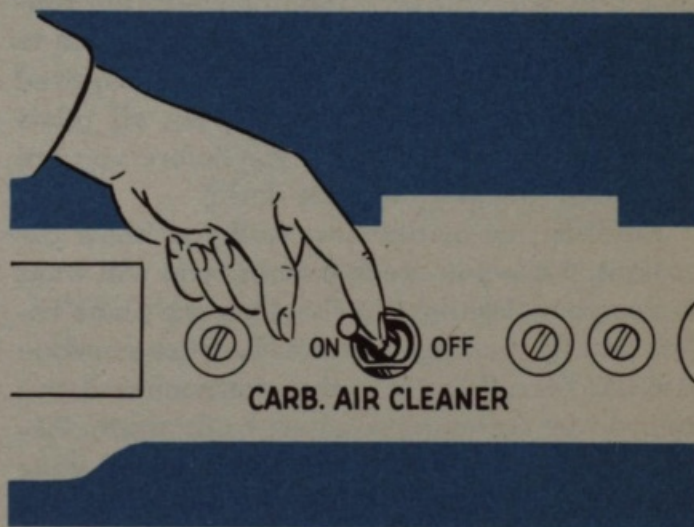

forces the air to flow through a cleaner. If, on the other hand, no dust is blowing, hold the filter switch in the OFF position for a few seconds to make certain the cleaner will not operate.



## NIGHT CHECKS AND INSPECTIONS

By the time you make your first night flight in a P-61 you will be so familiar with the routine of the cockpit check that you'll be able to do it blindfolded. In fact, you may be required to repeat the blindfold check given all pilots when they first fly the airplane before you are permitted to take it up after dark.

However, no matter how well you know the cockpit, while you are in training you will want to use your flashlight in checking the plane before you fly it at night. That is because someone else has been flying it in the afternoon and you want to be certain it is all set to fly again. Accordingly, don't worry too much about your night adaptation. It is more important to be sure of your plane's condition.

But when you reach a tactical area, your airplane will be made ready completely during the afternoon night flying test for you to fly it in darkness. By that time, too, you'll be able to make any necessary checks satisfactorily by

touch and the aid of luminous instruments. Remember that some instruments in the P-61 do not glow until the fluorescent lights in the cockpit have been turned on.

In your cockpit, also, there are four incandescent lights. One is over the propeller selector switches; another over the radio. A third is on the canopy above the pilot's right shoulder. The fourth is on the generator control panel. Test all four before takeoff at night, or in the daytime if you expect to return after dark.

An additional procedure, in checking the P-61 at night, is that of finding out whether your recognition, position, and landing lights are working. You need the help of the ground crew in checking most of these lights. You may turn on the position lights and leave them on. However, don't allow the recognition lights to burn for more than 10 seconds while the airplane is on the ground. Extend the landing lights fully and retract them as soon as possible.



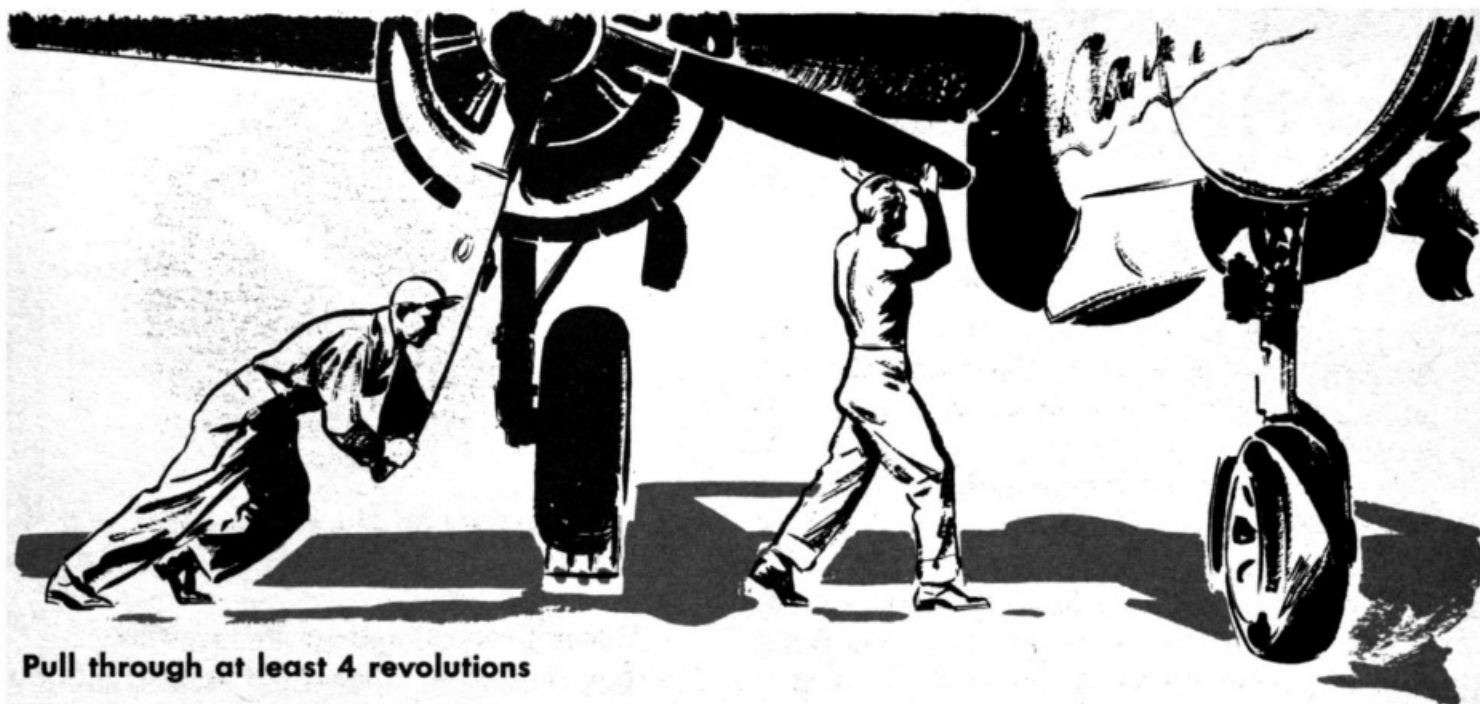

Pull through at least 4 revolutions

## STARTING

You are now ready to start the engines.

Before turning on the switches, first make sure the crew chief has pulled the propellers through at least four revolutions. This is necessary to remove the oil which has drained into the lower cylinders of each engine since the plane's last flight.

Each engine of the P-61 has a generator and hydraulic pump. Accordingly, it makes no practical difference which one you start first. For convenience, we'll first start the right engine.

Follow this procedure:

1. Turn on the ignition switch for the right engine.

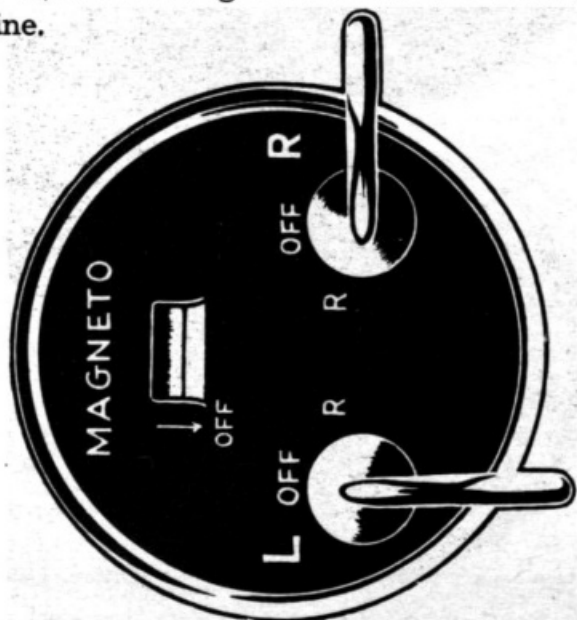

RESTRICTED

2. Recheck your throttle. The P-61's engines generally start more easily when the throttles are  $\frac{1}{3}$  open or more.

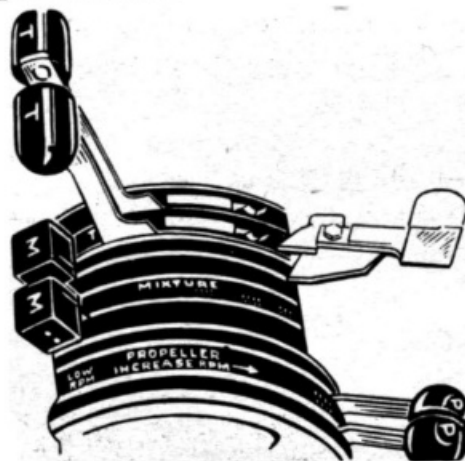

3. Be sure your mixture control is in IDLE CUT-OFF position. While the booster pump is ON, during starting procedure, the mixture control should never be out of the IDLE CUT-OFF position for more than a second or two. Otherwise, the induction system becomes flooded, creating a bad fire hazard.

It takes the starter about 20 seconds to gain the necessary momentum when batteries, either within the plane or on a battery cart, are supplying power. It takes only about half as long (10 seconds) to give the starter full momentum when you are using an auxiliary gen-

**RESTRICTED**

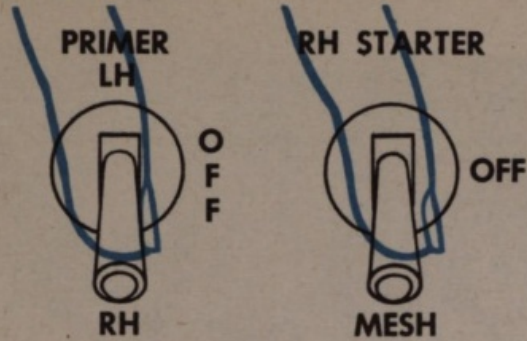

erator power supply. Under either condition, don't energize the starter longer than the time limits just given, or you will damage it by over-speeding.

If you use an external source of electrical power to energize the starters, turn OFF the master battery switch meanwhile.

Start the right engine first, but before you do so, put your head out the window and shout "Clear!" to the mechanic. **Be sure he answers** and understands you are about to start the engines. Also, make certain he has a fire extinguisher. There is one in each wheel well of the P-61.

Now, energize the right starter for the proper length of time. During the last 5 seconds of this interval, prime the right engine. The primer is spring-loaded and returns to the OFF position when released.

Then, just before you engage the right starter, shout "Clear!" again.

Engage the right starter. The engine starts turning over. As soon as it begins to fire, push



your mixture control forward to **AUTO RICH** and leave it there. If the engine does not start, **be sure the starter jaws are disengaged before you energize the starter for another try.** If your throttle has been opened  $\frac{1}{3}$  or more, pull it back quickly and smoothly as the engine picks up speed. This prevents backfiring.

Keep the starter engaged until the engine is firing smoothly, because the booster ignition

coil provides a nice, fat spark while the engine is running at low speeds. Now, turn off your

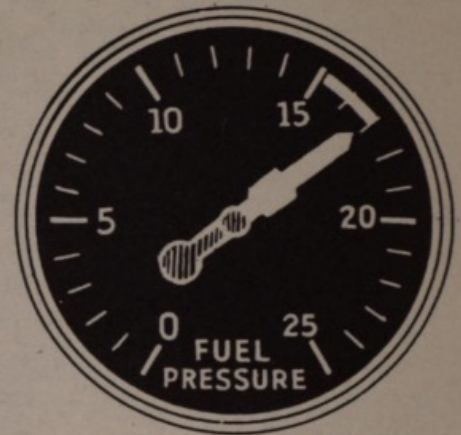

fuel booster pump and check to see that the engine-driven fuel pump is maintaining a pressure of 15-17 psi.

**It does no good to pump the throttles.**

Run the engine at from 600 to 800 rpm until you are certain there is oil pressure. If no oil pressure is indicated in 30 seconds, stop the engine and investigate the trouble. As soon as oil pressure shows, start warming up the engine from 1000 to 1200 rpm.

Repeat the entire starting procedure with the left engine.

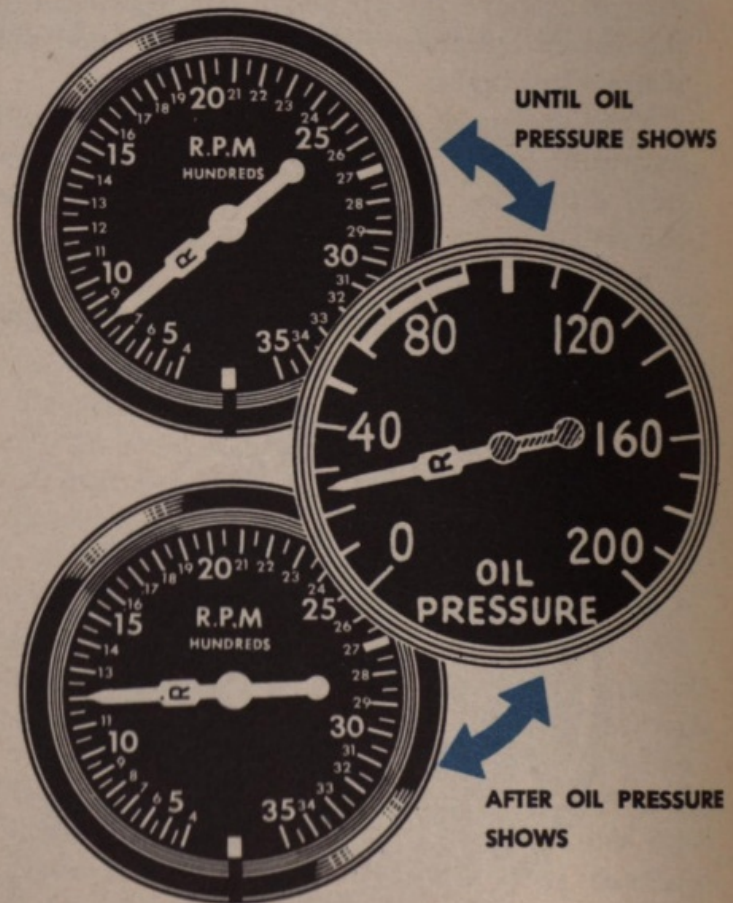

## MIXTURE...

If not one cylinder fires and no gasoline vapor issues from the exhaust stacks when an engine turns over, the mixture is probably too lean and there is not enough fuel in the primed cylinders. In this event, hold the primer down while continuing to turn the engine over. The engine generally starts after the primer has been on for 2 or 3 seconds.

If gasoline drips from the exhaust stacks

on the top cylinders, and gasoline vapor or heavy black smoke is blown from those cylinders, the cylinders are over-primed. Open the throttles wide and continue turning the engine over. The engine will usually start with this treatment. When it does, bring the throttle back immediately from the wide open position to the idling position (600-800 rpm). Keep the throttle there until oil pressure rises normally.

If, for any reason, it is impossible to use the electric starters, a hand crank is available. This will give some unhappy ground crew man a lot of exercise.

Continue warming up both engines until the oil pressure drops from its initial high of 150-200 psi to the normal operating range (25-85 psi), until the cylinder head temperature has risen to normal, and until the oil temperature is at least 40°C. **Do not begin your magneto check until these limits are reached.**

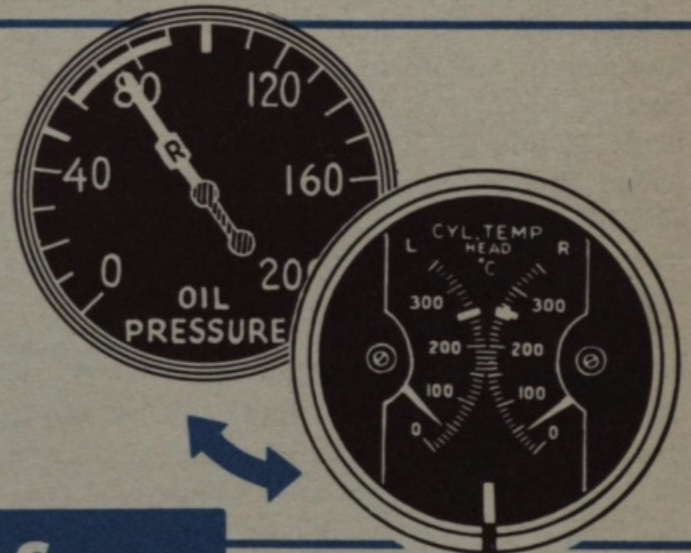

## FIRES...

### While Starting Engines

The pilot, as well as the ground crew, must be **fire conscious** and ready to take the proper action in case a fire breaks out while the engines are being started. Make sure you know the location of fire extinguishing equipment in the P-61, and **how to use it.**

**Remember always to keep on trying to start the burning engine, even while a**

member of the ground crew is using a fire extinguisher. Open the throttle wide. Cut the mixture control and fuel selector. **But keep turning the starter.** If the engine starts, it usually blows out any blaze.

If the plane you are flying has a built-in CO<sub>2</sub> fire extinguishing system, use it and abandon attempts to start the burning engine.

## RESTRICTED

While your engines are warming up, take the opportunity to check the operation of:

1. Cowl flaps. Leave them open.
2. Intercooler flaps.
3. Oil cooler flaps.
4. Wing flaps.

**Note:** Oil temperature rises more rapidly during warm-up if the oil cooler flaps are closed.

## WARNING

Never attempt to warm the engines more quickly by closing the cowl flaps. This may cause burning of the ignition wires at the spark plug elbows.

### Magneto Check (After Warm-Up)

When the right engine is thoroughly warm, begin a magneto check on that engine. The check will be more accurate if you **clear the engine** before you make the test. To do this, first run the manifold pressure up to almost 40" Hg. for 5 seconds, with the propeller control lever at full INCREASE RPM and the propeller selector switch in the CONSTANT SPEED position. While doing this, look over your right shoulder at the ammeter, to be sure the generator of the right engine is charging.

At the end of 5 seconds, reduce the manifold pressure to 30" Hg. The engine now should turn over at about 2100 rpm. It may not turn over at more than 1950 rpm, if there is a lot of time on it. If the tachometer reads less than 1950 rpm, however, something is wrong. Have the crew chief investigate.

Next, turn off one magneto. Notice the loss of rpm. This loss normally does not exceed 50

to 75 rpm. **It should not exceed 100 rpm.** On the other hand, if the tachometer does not register a loss at all there is something wrong. Ask the crew chief to find out what it is.

Now, check the other magneto in similar manner, but make your magneto check in as short a time as practicable. Running an engine at high manifold pressure on one magneto may cause serious detonation.

Then, check engine instruments on the right engine to see that they are reading properly.

Next, while the manifold pressure is still at 30" Hg., go through a propeller check on the right engine. To do this, first pull back the propeller control lever until the tachometer registers a drop of 200 rpm. Return the lever to full INCREASE RPM position. The tachometer should quickly return to its previous setting.

Then test the propeller selector switch by holding it in the DECREASE RPM position until the tachometer shows a drop. Now, move the switch into the INCREASE RPM position. Watch to make sure the tachometer indicates a rise. Then, return the switch to the CONSTANT SPEED position.

Next, put the propeller feathering switch in the FEATHER position. As soon as the tachometer shows a decrease in rpm, return the feathering switch to NORMAL.

Repeat all these checks on left engine.

Pilots frequently warm up their engines while taxiing to takeoff position. It saves time. Accordingly, they usually make their magneto and propeller checks at the end of the runway, while waiting for takeoff clearance.

## TESTING BLOWERS

In his daily inspection of your airplane, the crew chief normally checks the operation of the blowers. If you want to make a double check:

1. Be sure that engine and oil temperatures are normal for takeoff.
2. Move blower control levers for both engines to LOW. After a delay of several seconds, both oil pressure gages register slight drops. This indicates the blowers are beginning to operate. The manifold pres-

sure should rise slightly. Make this test at 1000 to 1200 rpm.

3. Move blower control levers to HIGH. The engine oil pressure again drops momentarily, indicating that the auxiliary blowers have been shifted from low to high rpm. The manifold pressure likewise should rise slightly.

4. After completing check, return both blower control levers to NEUTRAL without stopping in the LOW position.

# FLIGHT INSTRUMENT CHECK

Now, examine your flight instruments, to make sure they are set or operating properly :

1. **Compass**—Check heading with the known bearing of the runway. Also check freedom of movement while taxiing.

2. **Airspeed Indicator**—You have already made certain the pitot head cover is off and have checked pitot heat. When taxiing, note whether indicator needle moves in response to the wind.

3. **Rate of Climb Indicator**—Note if the needle is on zero.

4. **Altimeter**—Just before taxiing out, adjust it to the setting the tower has given you. Check this with the field elevation.

5. **Turn and Bank Indicator**—Check its reaction while making turns in taxiing.

6. **Artificial Horizon**—There are two of these instruments on a P-61. One of them is on the automatic pilot. **Check both.** They should be left uncaged during takeoff and landing. If you find them caged during the pre-takeoff check, uncage them and adjust the miniature airplane.

7. **Directional Gyro**—This should be left uncaged during takeoff and landing. If you find it caged, set to compass heading and uncage.

8. **Suction Gage**—When you make your engine run-up, this should indicate between 3.75" and 4.25" Hg.

9. **Carburetor Heat**—Apply full heat momentarily. CARB. AIR gage should show a rise. Turn radio ON. Set fuel to takeoff position.

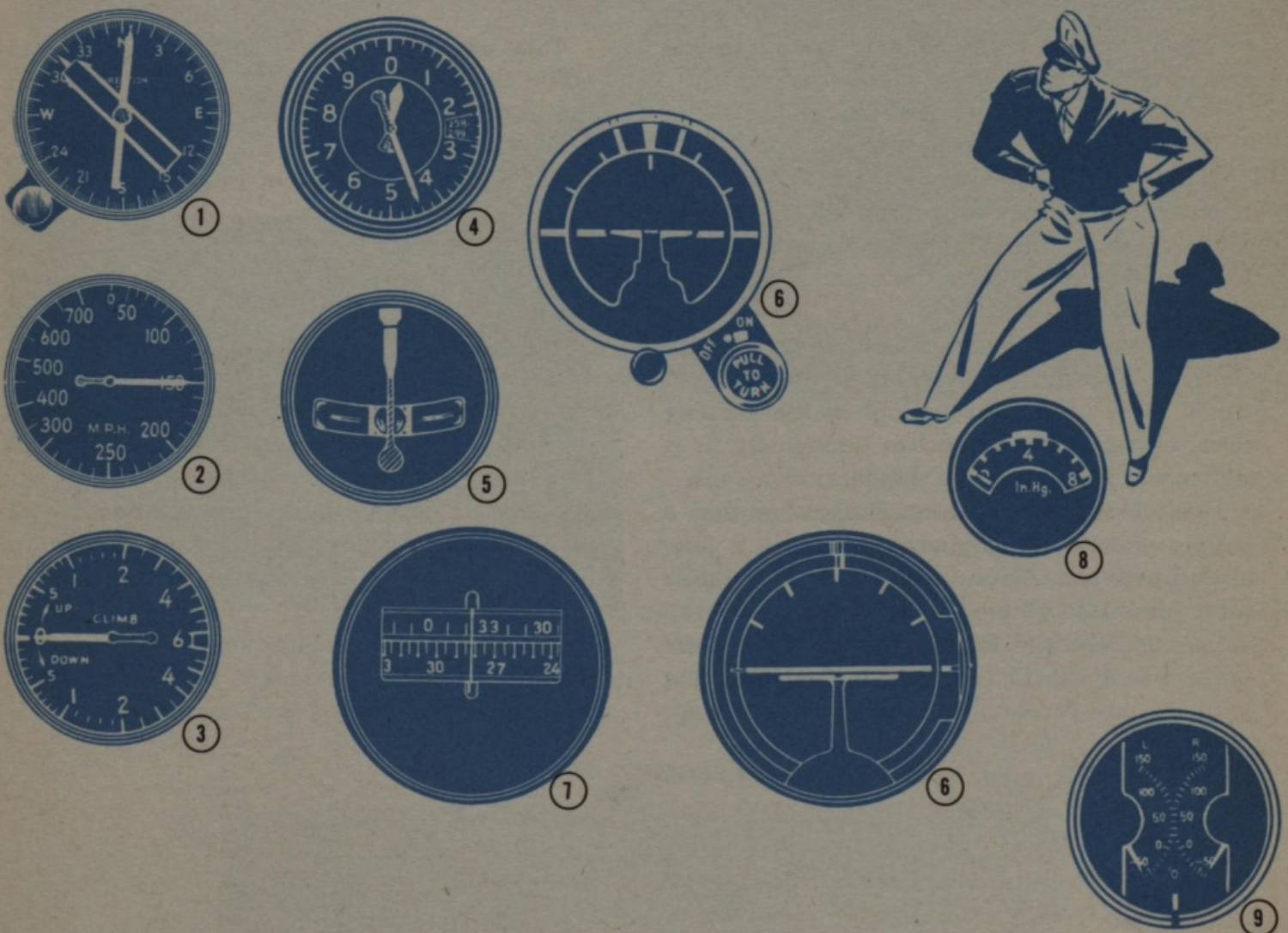

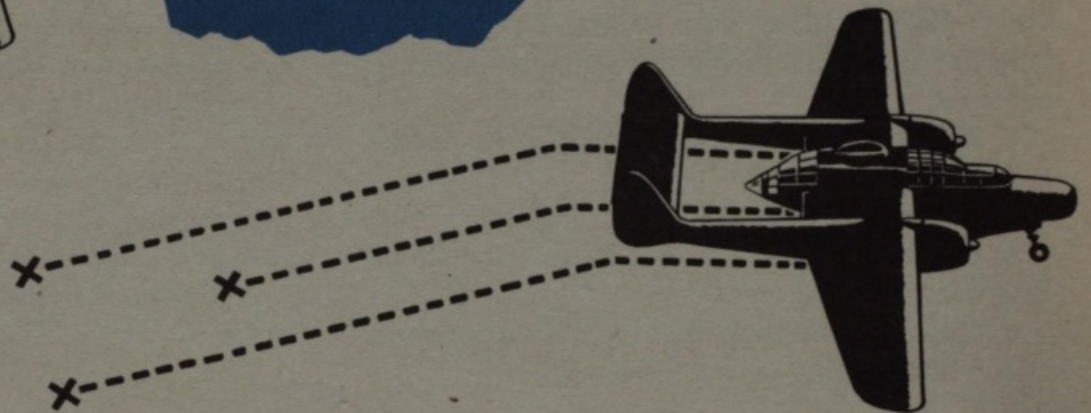
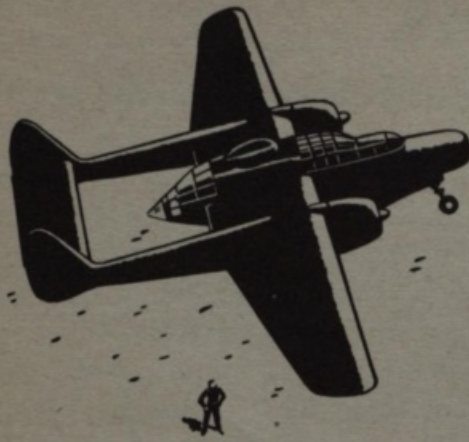

When you are ready to start taxiing, signal the crew to pull the wheel chocks away. At the crew chief's answering signal that all is clear:

1. Release your parking brakes.
2. Advance the throttles slightly and taxi out of the parking area. Get rolling forward before you attempt to turn. If the airplane is heavily loaded, you may damage the nosewheel by trying to turn against it.

Until you clear the parking area, do not taxi faster than a ground crew man can walk. At night, even when you are out of the parking area, be especially careful to taxi slowly. It is difficult to judge speed in the dark.

**Don't blast your engines.** Remember that a couple of 2000-Hp engines can create a fair-sized hurricane. At one Army field, a careless pilot blew two planes together with his prop wash and wrecked them both. Don't get **your** name on a Form 14 (accident report) by using your engines carelessly in taxiing and run-up.

Take advantage both of engines and rudders while taxiing. Be careful, though, not to run the engines too long at less than 1000 rpm. It fouls the plugs. And use the brakes sparingly. Don't forget the brakes of the P-61 are much

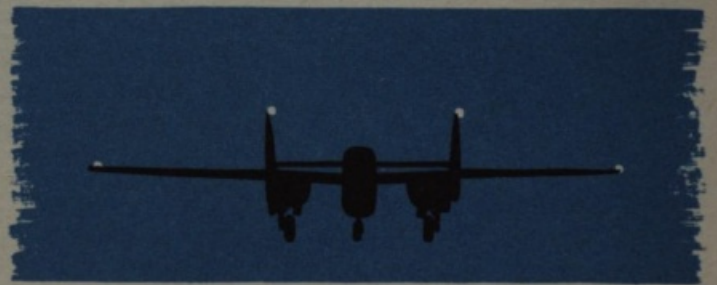

more sensitive than those of the P-70.

Use your taxiing light whenever possible at night. Don't forget to turn on your navigation lights after dark. The tower rather likes to know where you are.

Use the outside engine and full rudder in making turns. The rudder is more effective if you lighten the load on the nosewheel by hold-



**DON'T BLAST YOUR ENGINES**

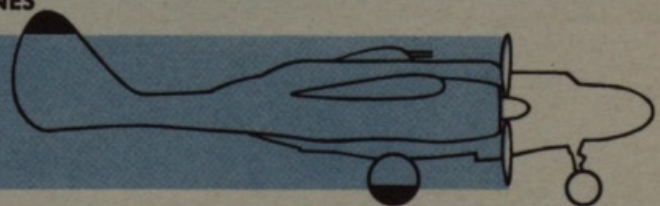

ing the control column all the way back.

Don't ride the brakes while taxiing. Use them only when necessary.

**Use of Brake**

Bear these facts in mind:

1. Brakes tend to heat up quickly.
2. Heat causes excessive wear. If you use brakes too much, you not only give the maintenance crew unnecessary headaches, but your brakes are likely not to be there when you need them most!
3. With too frequent or prolonged use of brakes, they may overheat and lock.
4. There is always this added danger: you may blow a tire because of overheated brakes.

IN MAKING TURNS USE FULL RUDDER

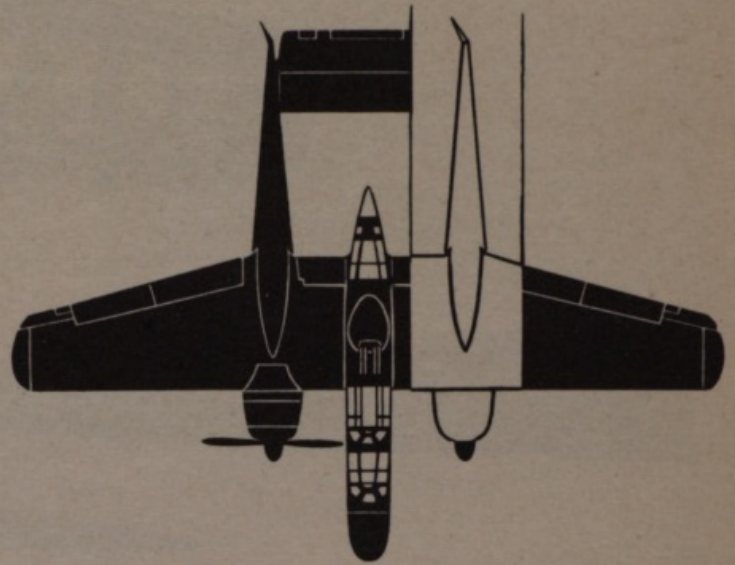

AND OUTSIDE ENGINE



DON'T LET YOUR RUDDER  
BLOW AROUND IN  
THE BREEZE

Taxiing in a crosswind, even a strong one, doesn't bother the P-61 much. However, give your upwind engine enough extra power to offset the weathercock effect from the crosswind and to avoid riding the downwind brake.

Don't let your rudders blow around in the breeze. This may crack hinges and lead to losing rudders in flight . . . a most embarrassing predicament.

Avoid rough handling of the throttles. Learn to apply power smoothly, evenly and only as needed.

Keep your head out of the cockpit. Taxi with your eyes wide open and your head turning to take in all sides. This is particularly important at night.



DON'T STAND ON YOUR BRAKES

# TAKEOFF



When you have taxied to the end of the runway and have finished your propeller and magneto check, take one more careful look around the cockpit **from left to right** to make sure the plane is set for takeoff.

**Here is an important precaution:** If, for some reason, you have altered the position of any control since you made your cockpit check, **look at it now** to be certain you have returned it to takeoff position.

**Pay special attention to the following points:**

- 1. Have your trim tabs been set (in neutral position) for takeoff?**
- 2. Are the fuel valves turned to the tanks you want to use (outboard tanks)?**
- 3. Is your throttle lock tight enough to prevent the controls from creeping?**
- 4. Are your fuel booster pumps on HIGH?**
- 5. Are your wing flaps set right? Set them where you want them from the UP position. Don't jockey them around or they won't be even.**
- 6. Are all three gyros uncaged and set properly?**
- 7. Are your upper engine cowl flaps closed and the lower ones cracked an inch?**
- 8. Is your automatic pilot OFF?**
- 9. Are your controls free?**



## ARE YOUR GYROS UNCAGED?

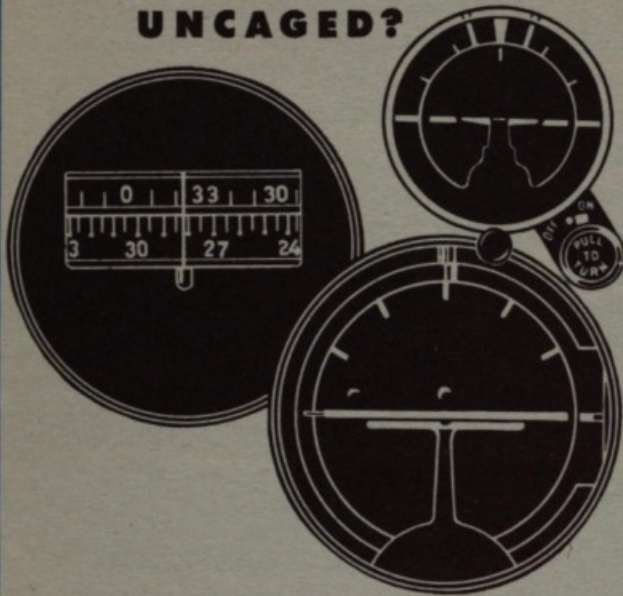

In the course of a year, at a Southern air base, four experienced pilots crashed during night takeoffs within a mile and a half of the end of the runway. Nine men were carried to their deaths. The pilots either had failed to uncage their gyros or had not used them during takeoff.

It is the practice of night fighter pilots both here and in England to go on instruments immediately upon leaving the ground after dark. They continue on instruments until the planes have gained at least 1000 feet of altitude.

## NORMAL TAKEOFFS (With Flaps)

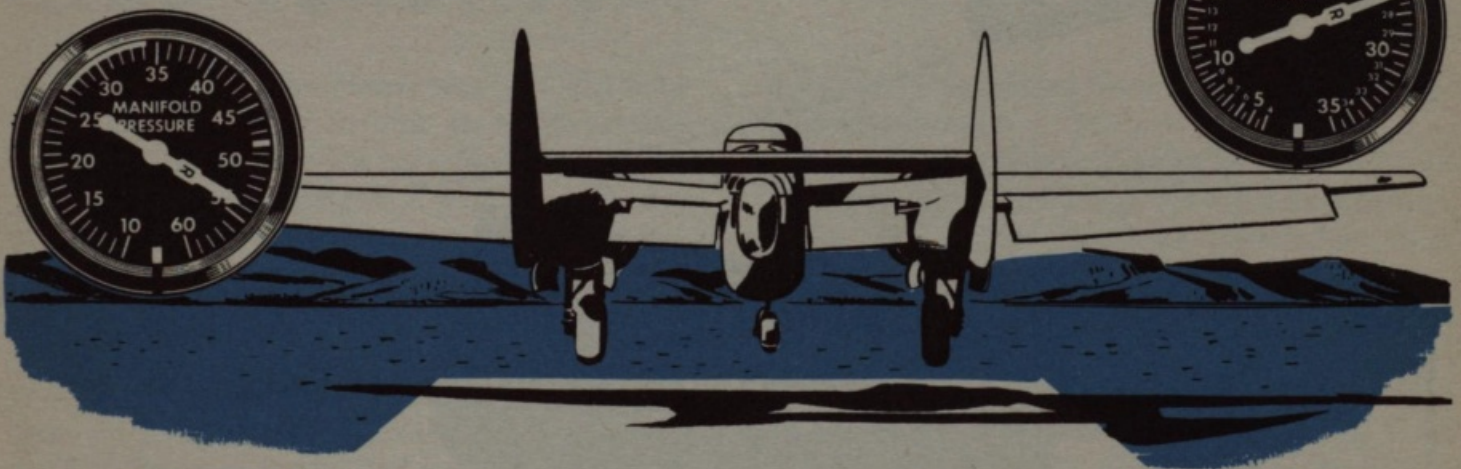

In a P-61, you can make the best and smoothest takeoff by using  $\frac{1}{3}$  flaps. After obtaining the control tower's permission for takeoff:

1. Turn on to the runway. Open both throttles to about 35" Hg. against the brakes to clear the engines. Release the brakes and smoothly apply full takeoff throttle (54" Hg. manifold pressure) to the engines. Keep the plane straight during its run with the rudders.

By the time you have opened the throttles to 54" Hg., the engines should be turning up 2700 rpm, the plane doing at least 50 mph, and you may raise the nosewheel off the ground. The plane is then in a flying attitude and as

soon as you have gained a speed of 100-110 mph IAS, it lifts itself off the ground.

Raise the landing gear as soon as the plane is safely off the ground. Level out long enough to attain critical single engine speed (110 mph IAS at 28,000 lbs. gross weight).

Critical single engine speed is the slowest speed at which the rudder has a safe margin of control over the unbalanced thrust of a single live engine at maximum power. So long as you have critical single engine speed, you are able to fly or land the airplane in the event one engine fails.

Never begin your climb until you have at-

## RESTRICTED

tained this essential speed.

Raise the flaps as soon as possible after attaining critical single engine speed and **500 feet altitude**. The flaps may not lock in the up position if they are raised at over 175 mph IAS.

Turn off booster pumps, unless you are going to climb above 15,000 feet, or unless the engine-driven pumps will not maintain 15-17 psi. If they won't, land and find out what the matter is.

You normally maintain an indicated airspeed of 165 mph, up to about 20,000 feet, while climbing. If you make long climbs at lower IAS you overheat the engines, except in cold weather.

Above 20,000 feet, while climbing, you may reduce your IAS somewhat, varying it according to the oil and cylinder head temperatures registered. **Never allow the oil temperature to rise above 100°C or the cylinder head temperatures to exceed 260°C.**

In a short, rapid climb, you can obtain maximum rate at an IAS of 140 mph with full military power (54" Hg. and 2700 rpm). **Remember, this is for short climbs only. Save it for emergency use.** Lower IAS and full power cause oil and cylinder-head temperatures to rise swiftly.

## NORMAL TAKEOFFS (Without Flaps)

LESS THAN 30,000 LBS.



STEEPER ANGLE

The P-61 makes a nice takeoff without flaps, provided the gross weight is below 30,000 lbs. Above that weight, use  $\frac{1}{3}$  flaps.

Without flaps, however, you must raise the nose to a steeper angle during takeoff than is necessary during takeoffs with flaps.

### TRIMMING YOUR SHIP

To get the most out of your airplane, you must keep it in trim. This is especially true in instrument flying. As a night fighter pilot, you will be flying on instruments most of the time.

On takeoff, improperly set trim tabs can cause loss of control. During flight you can work yourself to death if you do not use trim tabs.

The P-61 trims as easily as the P-70. There is only a slight torque effect notice-

able in climbing and diving. Consequently, you seldom set the rudder trim tabs more than 2° from neutral (zero) either way. You must use the elevator trim tab to compensate for any change of attitude or speed.

Because of the type of aileron used on the P-61, the aileron trim tab is practically unnecessary and has almost no effect. Accordingly, beginning with the P-61B, it has been eliminated.

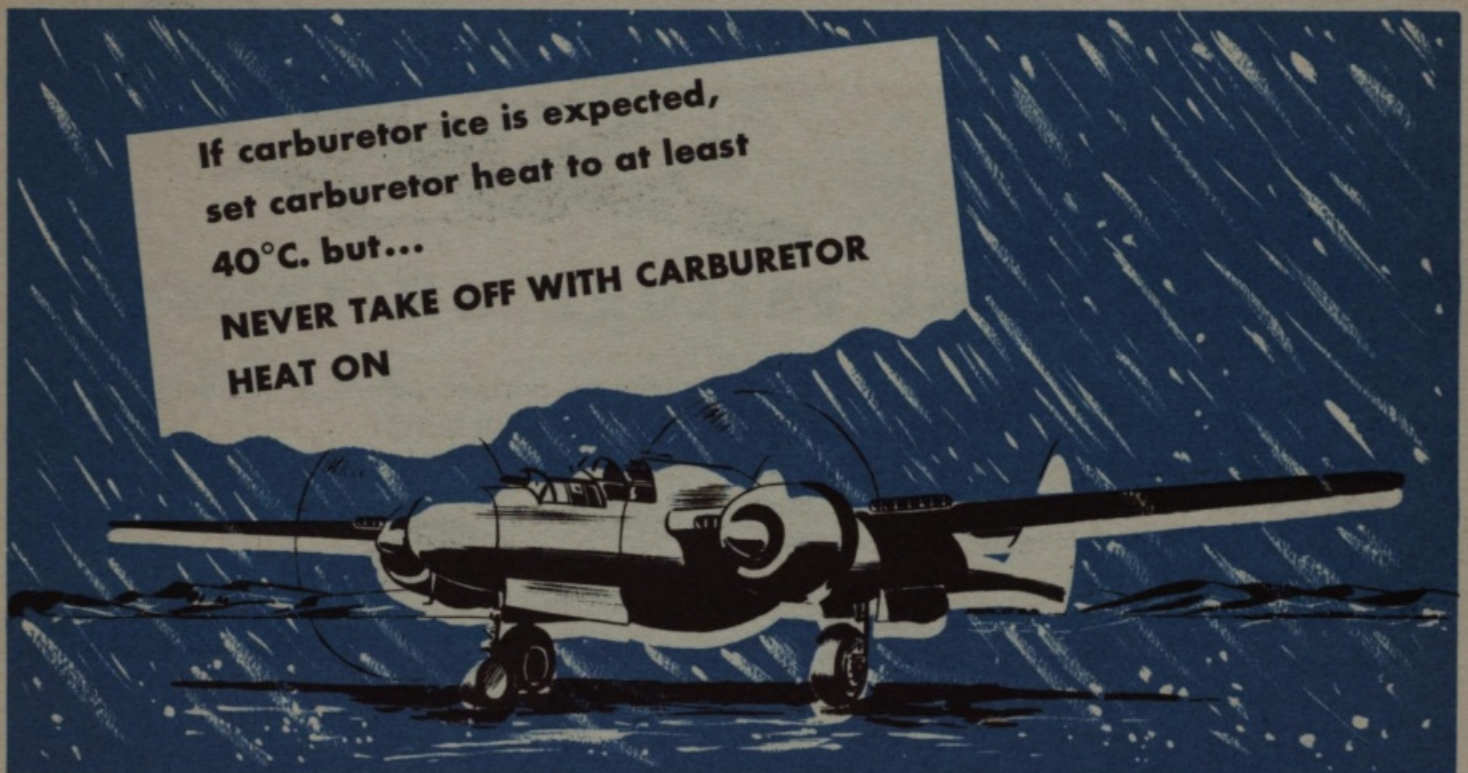

## ICING CONDITIONS

Icing conditions are more likely at night than in the daytime. If carburetor air temperatures warn that carburetor ice may form during engine run-up and taxiing, at a fixed throttle setting put the carburetor heat control ON. Leave it on until the carburetor air temperature rises to at least 40°C. Turn it OFF and return the control to LOCKED position for takeoff. When you have climbed to 1000 feet, turn the carburetor air temperature control ON again, if you need it. Don't use it in flight unless it's necessary. It causes you to use more fuel than you need and encourages detonation at high powers.

As a matter of fact, carburetor ice is not likely to form in P-61 engines, especially when the auxiliary blowers are operating. However, if ice does form, turn the carburetor heat control ON long enough to remove the ice, and then turn it OFF. If icing conditions persist, you may keep on using carburetor heat.

Warning of the presence of carburetor ice is given by a drop in manifold pressure when you're using NEUTRAL blowers. In the other blower positions, no such drop in manifold

pressure is registered because of the automatic blower regulator.

Keep the intercooler doors closed as much as possible, unless carburetor air temperatures are above 32°C. This maintains carburetor heat when you're using LOW or HIGH blowers.

In case propeller icing is possible, turn the propeller anti-icing control on full for approximately one minute at low engine rpm just prior to takeoff. This distributes the anti-icing fluid over the entire length and breadth of the blades before ice is actually encountered.

The old adage, "An ounce of prevention is worth a pound of cure," is especially true in fighting propeller ice. If your propeller blades are thoroughly coated with anti-icing fluid before you take off, ice never has a chance to form. On the other hand, once the ice has formed, it is practically impossible to remove it from the leading edges of the blades, especially near the tips.

Never use the de-icer boots during takeoff or landing, no matter whether ice is present or not. They play nasty tricks with your stalling speed, for they act as spoilers.

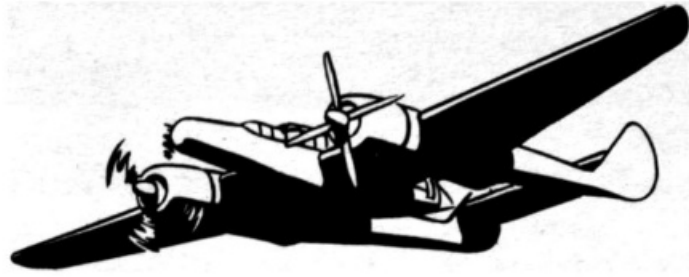

## SINGLE ENGINE FAILURE ON TAKEOFF

You already know that a two-engine airplane can be flown and landed safely on one engine so long as you know how to do it. Fortunately, the P-61 performs unusually well on one engine. But don't be overconfident, just because the plane you are flying is exceptionally controllable. It is always hazardous to lose an engine during takeoff. **You've got to know what to do.** These are the basic rules:

1. **If you are carrying wing tanks, drop them as quickly as possible.** Do this first, whether an engine fails while you are still on the ground or after you are in the air. You don't want to make a crash landing surrounded by 1200 extra gallons of gasoline. For obvious reasons, if you are carrying bombs, drop them (unarmed) too.



2. **If one engine fails before the plane has left the ground, cut power on both engines and stop straight ahead.** If it is apparent that you will run off the end of the runway before you can stop, **get your wheels up fast!**



3. **If one engine fails in the air, but before the airplane has attained critical single engine speed, cut the power on both engines and land straight ahead.** Obviously, if the wheels have already been retracted, you will make a wheels-up belly landing. If the wheels are still down, and there isn't enough runway left for you to

make a normal power-off landing, get the wheels up in a hurry!

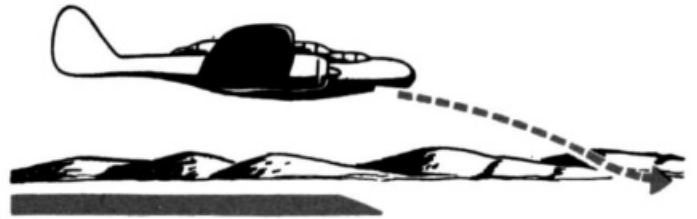

4. **Never try to turn more than 15° or 20° in attempting to land straight ahead after one engine has failed during takeoff.**

5. **If one engine fails in the air, after critical single engine speed has been attained, feather the propeller on the dead engine, continue single engine flight and circle for a landing.**

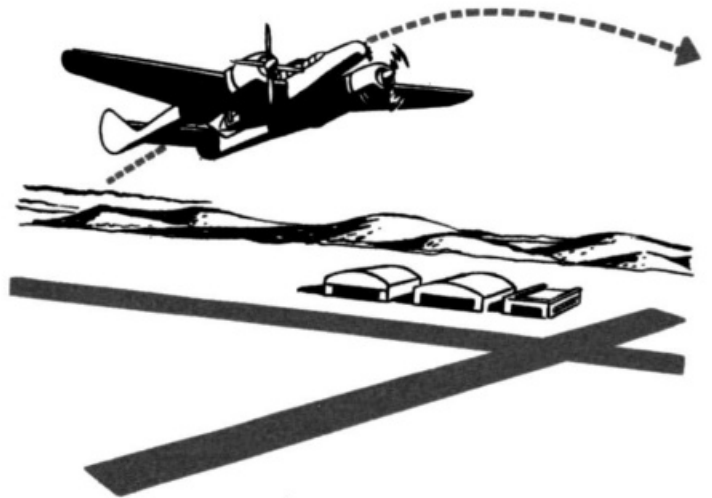

**CHECK TABLE ON PAGE 66  
TO FIND CRITICAL SINGLE ENGINE  
SPEEDS AT VARIOUS  
LIKELY WEIGHTS**

## CROSSWIND TAKEOFFS

You find little difficulty in taking the P-61 off the ground in a crosswind. Just be especially careful to keep it going straight down the runway. You normally do this with the aid of a little rudder on the downwind side, at the same time rolling your ailerons slightly into the wind. In very strong crosswinds, use a slight lead on the upwind throttle for additional control.

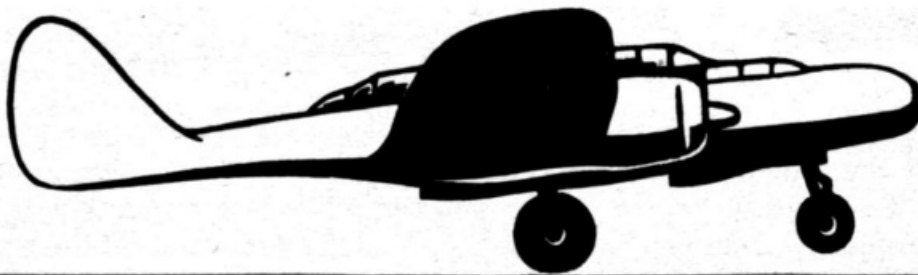
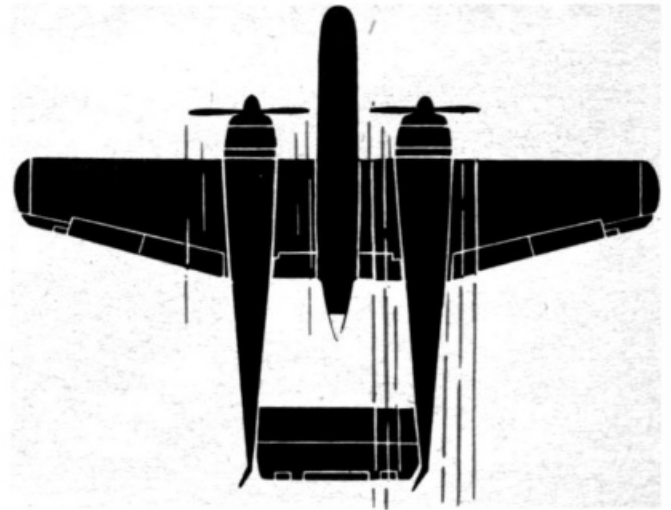

Raise the nose at the usual time (50-60 mph), but keep both main wheels solidly on the runway until you have attained plenty of speed for takeoff. Then pull the plane smoothly and

cleanly off the runway to avoid bouncing. Any bouncing is made with the drift, and therefore is extremely hard on the landing gear. The landing gear isn't built for heavy side stresses.

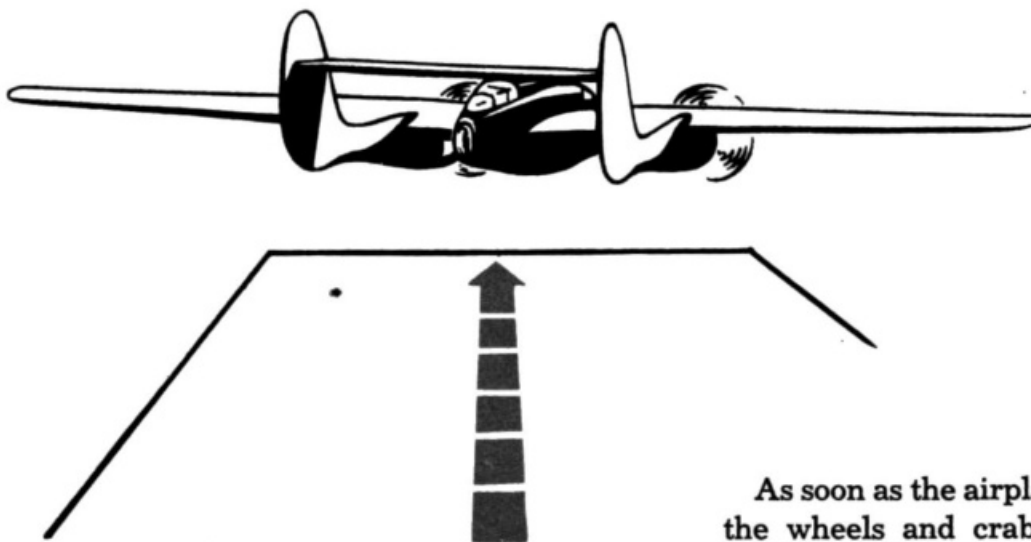

As soon as the airplane is off the ground, raise the wheels and crab into the wind to avoid drifting off the line of the runway.

## SHORT-FIELD TAKEOFFS

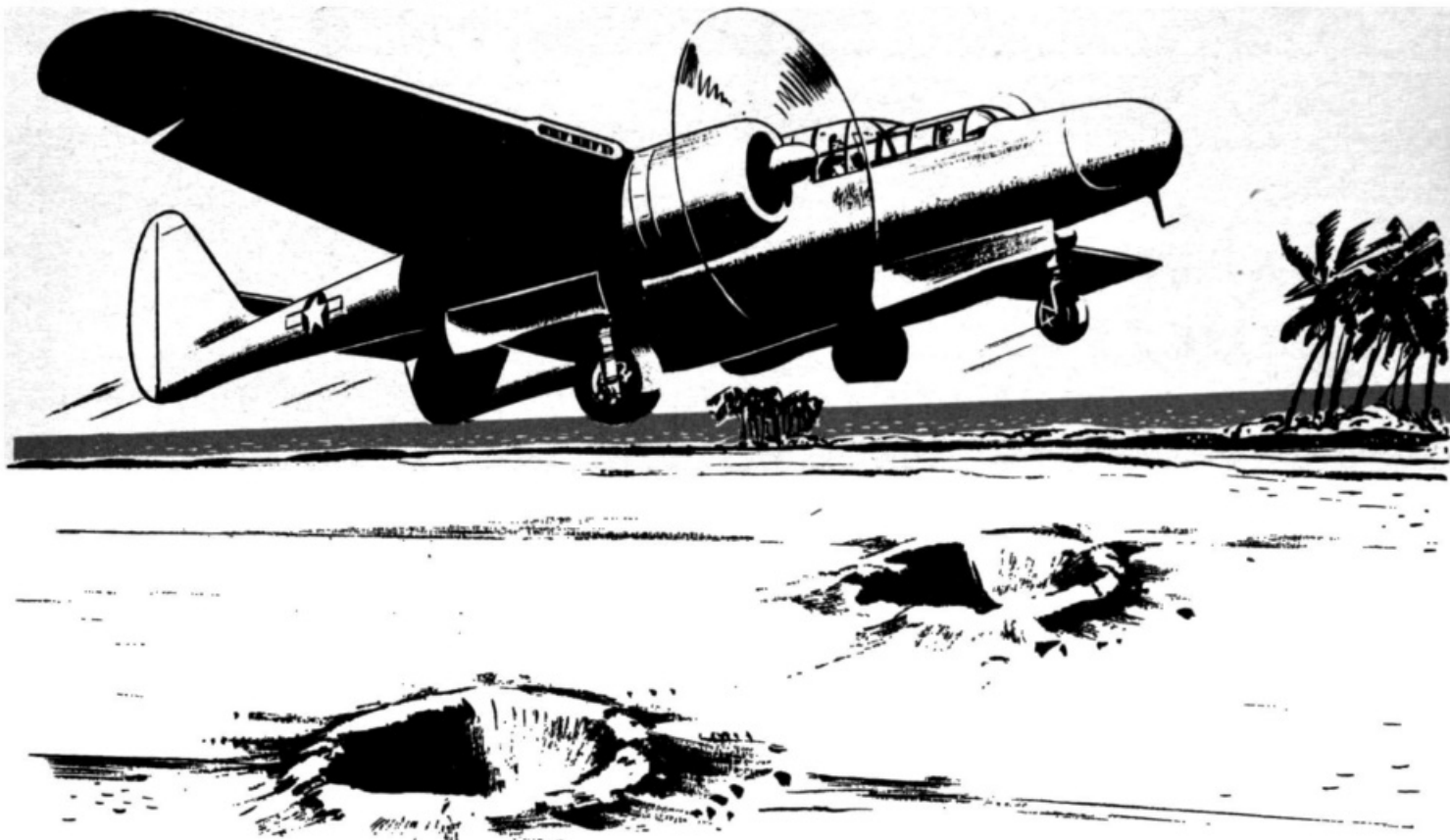

Suppose you are on a field pitted with bomb holes. You must get off the ground as soon as possible. However, we'll assume there are no obstacles to clear. Therefore, you do not have to pick up altitude quickly.

1. Make the usual pre-takeoff check.
2. Lower your wing flaps  $\frac{2}{3}$ .
3. Line up for takeoff as close to the end of the runway as possible.
4. Run the engines to full takeoff manifold pressure (54" Hg.) against the brakes.

5. Release the brakes and start your run, but keep the nosewheel on the ground as long as you can while picking up speed.

6. Pull the nosewheel off the ground and take off as soon as you have reached flying speed (75 mph at 29,000 lbs. gross weight). Then, raise the wheels and level off to attain critical single engine speed before climbing.

In short-field takeoffs, you may use your water injection system to increase the engines' horsepower and help you get off sooner.



## TAKEOFFS OVER OBSTACLES

Fields bordered by obstacles generally are also short. To take off under these conditions, follow the procedure of a short-field takeoff, with the following exceptions:

1. Take off at the last possible moment.
2. After getting off the ground, raise your wheels and climb steeply until you have cleared the obstacle. Then level off to gain speed.

## NIGHT TAKEOFFS

Before you fly a P-61 at night you must really know your cockpit. You must be able to tell by touch whether the controls are correctly set and be able to reach accurately for levers without hesitation.

Always have a flashlight within reach, in case the airplane's electrical system fails while you are in the air.

During your training period, it is not always practical for you to be completely night adapted before flying. That is because you are going to fly a plane which someone else has been flying. It should be checked thoroughly before you take off. You will probably do this with the aid of a flashlight and, in the process, lose what night adaptation you had.

In a combat area, however, you fly your

own plane and make your NFT (night flying test) the afternoon before you fly. Your plane is always all set for you to hop in and scramble. Under these conditions, you must be night adapted. Any light would doubtless attract unwelcome visitors other than insects.

Under combat conditions, you make the usual pre-takeoff check by touch and the use of fluorescent instrument lights. **Be absolutely certain your gyro instruments are uncaged and properly set.**

After the normal run-up, line up your plane with the flare path, give her the gun, get off the ground, and go on instruments from the time you are airborne until you reach an altitude of at least 1000 feet. Your margin for error below that is nearly nil.





## LANDING

While approaching a field on which you plan to land, but **before you have entered the traffic pattern:**

1. Be sure your fuel valves are turned to the fullest tank. Many an accident has occurred because a pilot carelessly turned to an empty tank instead of a full one while coming in from a long flight. **Make certain you have turned to the tank you intend to use.** Do not land while using the fuel from a bomb rack tank.

2. Set your mixture controls at **AUTO RICH.**

3. Turn off the automatic pilot.

4. Turn off the de-icer boots.

5. Make sure the gun turret is locked in the forward position.

6. Turn your booster pumps to **HIGH.**

7. Set the supercharger at **NEUTRAL.**

8. Turn cockpit heaters **OFF.**

Once you are on the downwind leg of the traffic pattern, check the following:

1. **Landing gear.** Put it down at less than 175 mph IAS. Be sure it is down and locked. Check your warning horn and the landing gear indicator on the instrument panel. Also, **look** to see if the wheels are extended. As the landing gear descends, the nose of the plane rises until the wheels are about half way down. From that

point on, the plane's nose drops and you have to re-trim the elevators.

2. **Cowl flaps.** Generally, you close them for landing.

3. **SYSTEM and ACCUMULATOR hydraulic pressures.** They should indicate 800-1100 psi.

4. **Brakes.** Test them to see if they feel normal.

5. **Propellers.** Increase to 2400 rpm on the base leg.



**LEVEL FLIGHT  
With  
Wheels Down**

You need about 25" Hg. manifold pressure at 2400 rpm to maintain level flight with wheels down at 150 mph IAS and with a gross weight of 26,000 lbs.



- SWITCH TO FULLEST TANK
- MIXTURE AUTO RICH
- AUTOMATIC PILOT OFF
- TURN DE-ICER OFF
- BOOSTER PUMP HIGH
- SUPERCARGER NEUTRAL
- COCKPIT HEATERS OFF

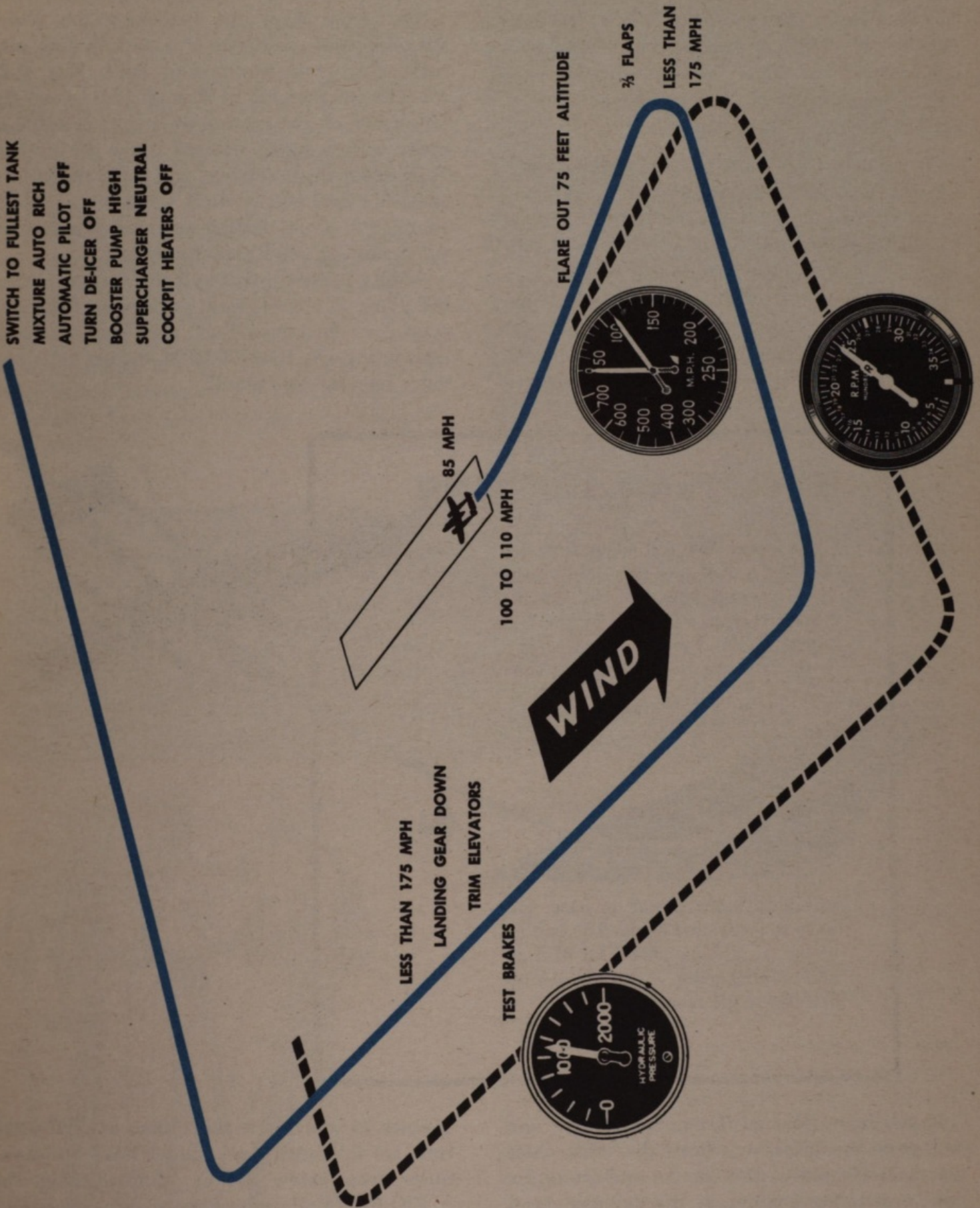

## RESTRICTED

When you turn on to the approach leg, put your flaps down, but never when the plane is traveling faster than 175 mph IAS. As the flaps go down, start rolling back on the elevator trim tab, because the flaps make the airplane nose down rather steeply. You can make a good, smooth landing with  $\frac{2}{3}$  flaps.

At the average landing weight of the airplane (26,000 lbs.), you should maintain an approach speed of 105-110 mph IAS, and the ship should be slightly nose heavy in trim, to avoid difficulty if you have to go around. It is necessary to use 10" to 15" Hg. manifold pressure to keep the glide from becoming too steep. Don't get careless and let your speed drop too low on the approach or in the pattern. The airplane will

probably not spin if it stalls, but you won't have enough altitude left to recover from the stall.

Start your flare out (breaking the glide) smoothly and gradually at about 75 feet altitude. Cut your power and land. The P-61 touches down nicely at 85 mph IAS. Keep the nosewheel off the ground as long as possible in order to lose speed without using the brakes. Then lower the nosewheel and apply the brakes smoothly and evenly until the landing roll is completed. Avoid putting too much pressure on the brakes, or you'll skid the wheels.

After you have turned off the runway, bring the plane to a stop, raise your wing flaps and open your cowl flaps. Push your propeller controls to full INCREASE RPM and set your elevator trim tab for takeoff.

### FULL-FLAP LANDING

You may use full wing flaps for landing a P-61 any time you desire. Bear in mind, however, that the approach is steeper in order to maintain airspeed. Your flare out must start a few feet higher, and it requires con-



siderably more power in case you have to go around again. The last  $\frac{1}{3}$  of the wing flaps adds a lot of drag and braking action and practically no increase in lift over the first  $\frac{2}{3}$ .

If you have finished flying, taxi to the line and park the airplane where the crew chief wants it. He places the chocks and waits for you to stop the engines. If the cylinder head temperatures are high, after landing, allow the

engines to idle for a short time at 1000-1200 rpm. Do this until the cylinder head temperatures drop below 205°C. Mixture must be AUTO RICH, oil cooler flaps must be open, and all cowl flaps must be open.

### How to Stop the Engines

To stop the engines, move the mixture control levers to IDLE CUT-OFF and slowly open the throttles all the way. Turn the ignition switches OFF when the engines have stopped. Turn off all the other electrical switches before you leave the plane. Leave the mixture controls in IDLE CUT-OFF and do not shut off the fuel tank selector valves.

If IDLE CUT-OFF doesn't stop the engines, close the throttles, turn the ignition switches OFF and slowly open the throttles wide as the engines quit. Have the IDLE CUT-OFF adjusted properly as soon as possible.

If the weather is cold, use your oil dilution system before the engines are stopped and after the cylinder head temperatures have dropped below 205°C.

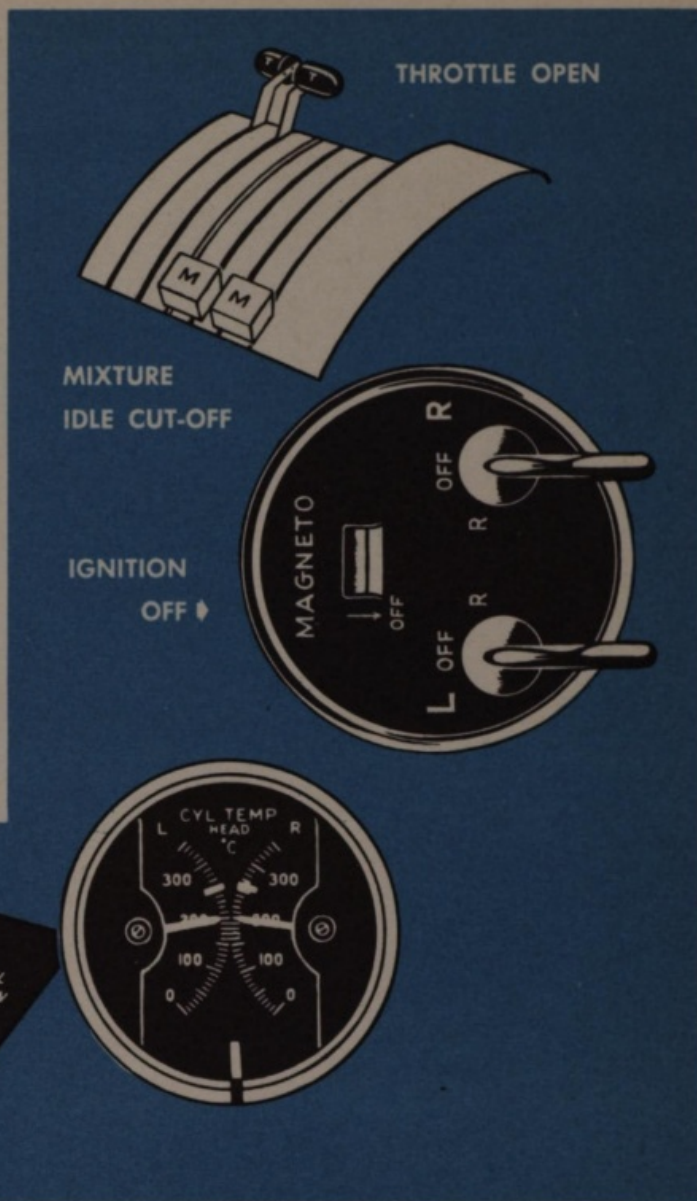

IF THE WEATHER IS COLD USE YOUR OIL DILUTION SYSTEM

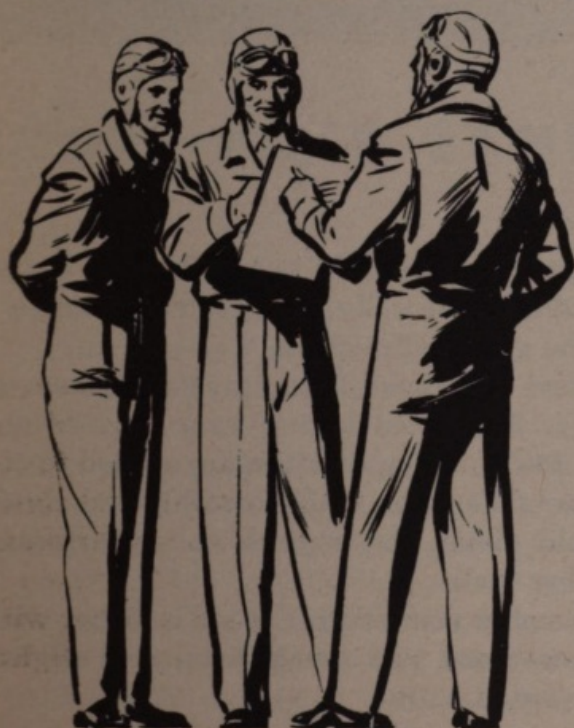

### Afterflight Check

Lock the flight controls before you leave the cockpit. Set the lock by moving the lever into the ON position. Then gently move the elevator, aileron, and rudder controls until you feel them lock in neutral.

Don't set the parking brakes if they're hot, or the mechanic later may have to take them apart to move the airplane.

Before you and your crew walk away from the plane after a flight, go into a huddle to see if they've found anything you should enter on the Form 1. If they have, put it down on paper right away. Don't say to yourself, "I'll have to see the crew chief about that." He may be out having a coke when you hunt him up, and then you'll forget it.

# POWER-OFF LANDINGS

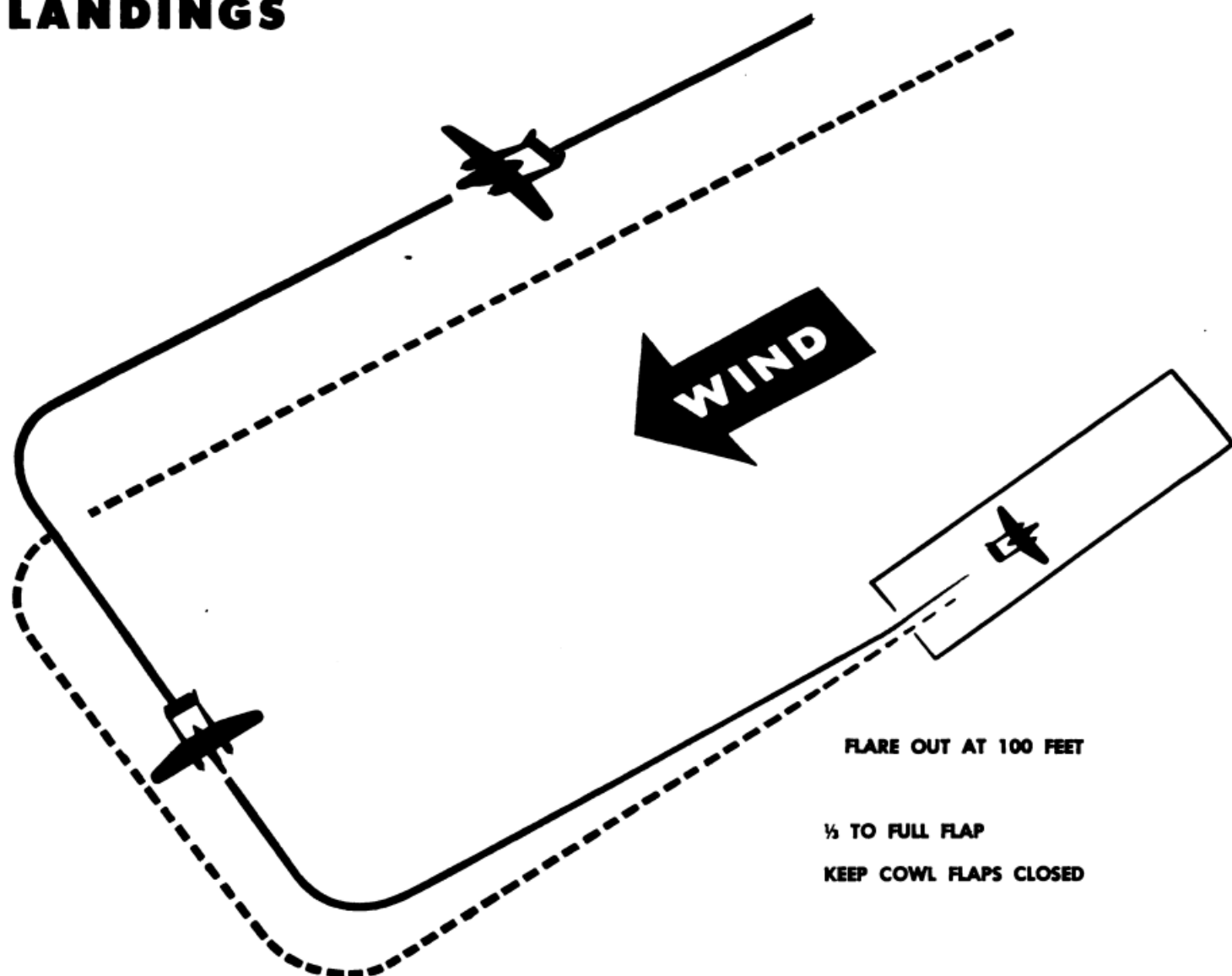

Power-off landings in a P-61 require an unusually steep approach to maintain gliding speed. This is because of the exceptionally large flap area on the airplane.

You should maintain an IAS of 110-115 mph during the approach, and start your flare out smoothly and gradually at 100 feet above the level of the runway.

Your tendency during the first few power-off landings is to undershoot the field by a wide and uncomfortable margin. So be ready with the throttles to correct your error in judgment.

You may use from  $\frac{1}{3}$  to full flaps on power-off landings. Naturally, the greater the angle of flap, the steeper the glide.

Always close cowl flaps in making power-off landings and avoid letting your engines cool below 100°C. When throttles are opened to correct the glide, open them smoothly and slowly to avoid giving the engines an embarrassing coughing spell.

**Remember your stalling speed is higher without power and you touch down at a slightly higher speed.**

# POWER-OFF LANDINGS

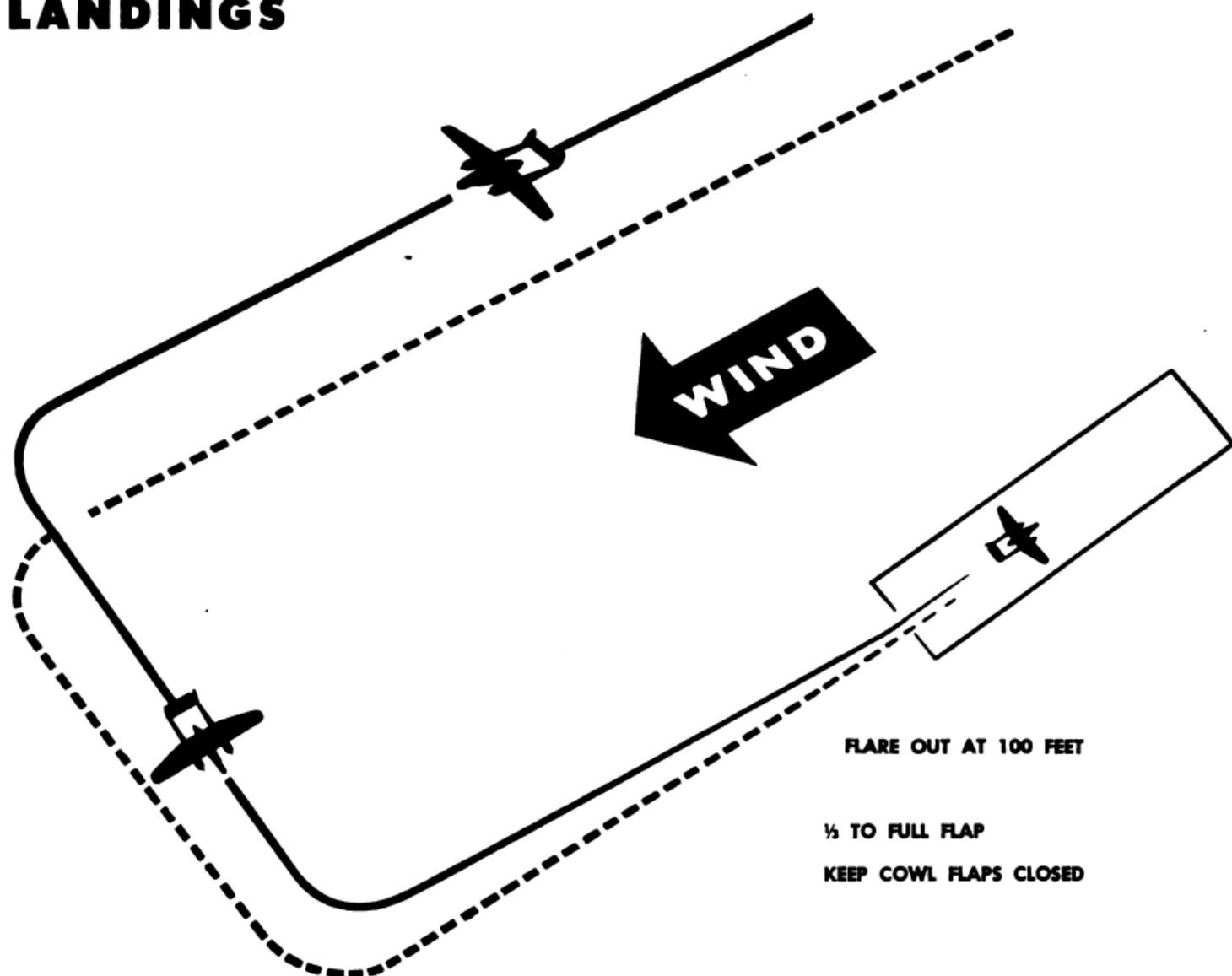

Power-off landings in a P-61 require an unusually steep approach to maintain gliding speed. This is because of the exceptionally large flap area on the airplane.

You should maintain an IAS of 110-115 mph during the approach, and start your flare out smoothly and gradually at 100 feet above the level of the runway.

Your tendency during the first few power-off landings is to undershoot the field by a wide and uncomfortable margin. So be ready with the throttles to correct your error in judgment.

You may use from  $\frac{1}{3}$  to full flaps on power-off landings. Naturally, the greater the angle of flap, the steeper the glide.

Always close cowl flaps in making power-off landings and avoid letting your engines cool below 100°C. When throttles are opened to correct the glide, open them smoothly and slowly to avoid giving the engines an embarrassing coughing spell.

**Remember your stalling speed is higher without power and you touch down at a slightly higher speed.**

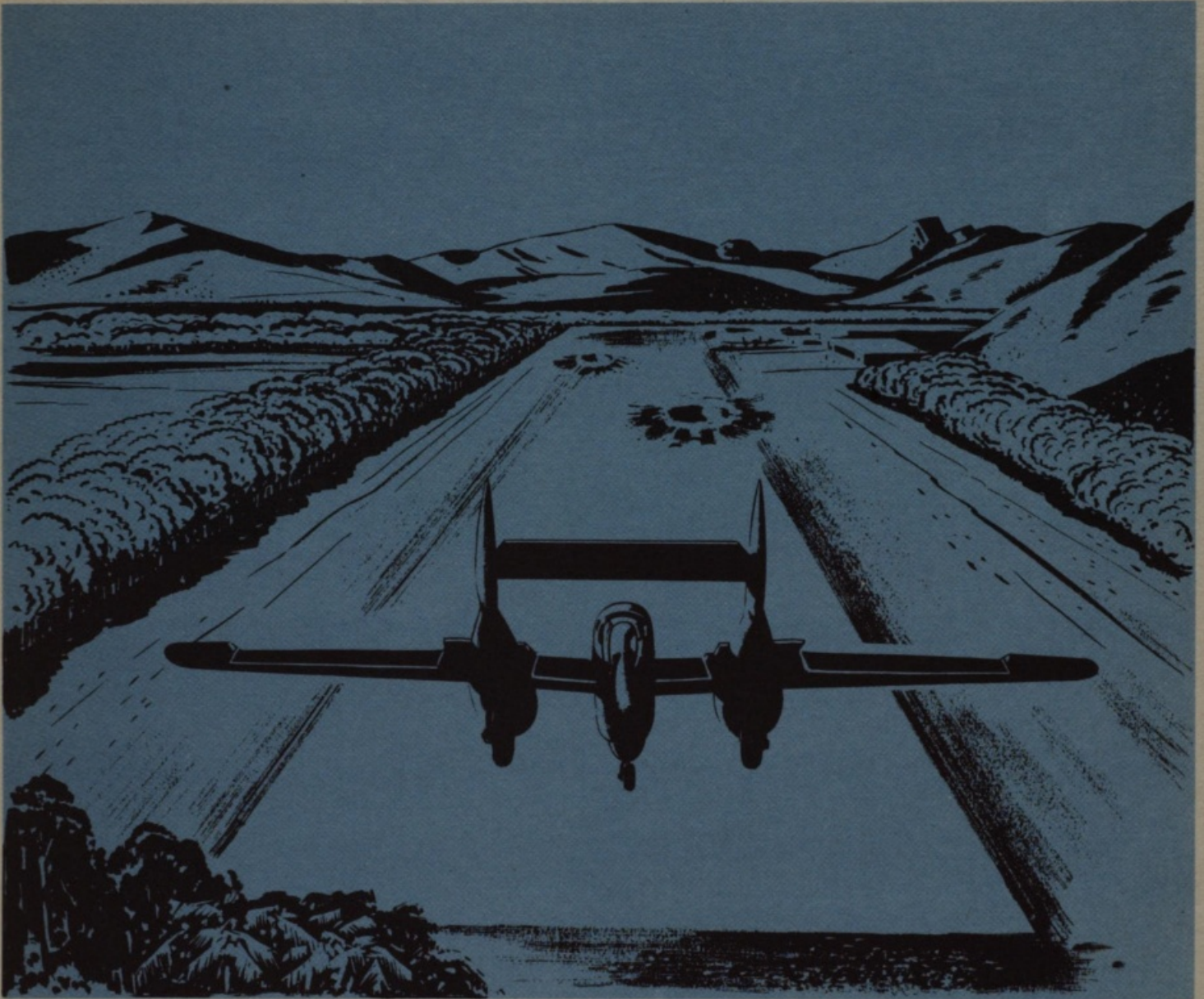

## SHORT-FIELD LANDINGS

You normally make short-field landings under one of two conditions:

1. When the field is naturally short.
2. When part of the runway has been destroyed by bombs.

The full-flap, wheels-down stall, both with power on and power off, and slow flying are the basis for short-field landings. In fact, you must be proficient in these three maneuvers before you can make good short-field landings.

When you make a short-field landing:

1. Establish a normal full-flap glide with

power, in order to undershoot the field slightly.

2. Hold normal speed throughout the flare out, then gradually pull up the nose, increase power, and go directly into slow flying. Do this when you are close enough to the ground to land as soon as the power is cut.

3. As you approach the point where you want to land, cut the power. Since the airplane is already at the power-off stalling speed, you can make the landing easily. You may use maximum permissible brakes, **but do not skid the tires.**

# APPROACH OVER OBSTRUCTIONS

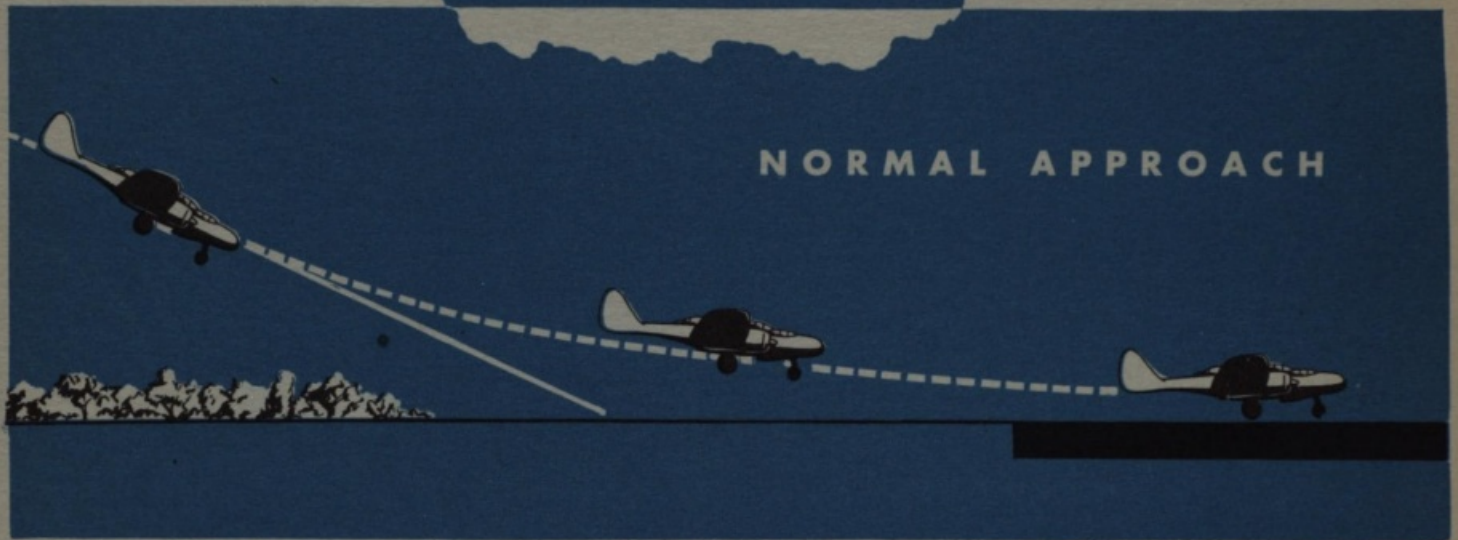

Obviously, the type of approach described above isn't practical if you are landing over an obstruction. In approaching over an obstruction, establish the base leg so that you can make a fairly steep power approach, clear the obstacle, and touch the wheels as soon as possible after you have cleared it.

Plan your glide so that you can clear the obstacle by **power** rather than by depending upon your judgment as in the power-off approach. Reduce speed according to the height of the obstacle.

Bring the airplane to a 3-point attitude and

control the rate of descent as you approach the obstacle. The approach path governs how high above and how far behind the obstacle the airplane should assume this position.

As the airplane approaches the ground, your speed should be the power-off stalling speed. The rate of descent should not exceed 1000 feet per minute.

Under the above conditions, you can cut power as soon as the plane is close enough to the ground for a safe landing.

**Be careful not to drop in too hard** as a result of cutting power suddenly.

# CROSSWIND LANDINGS



**WIND**

It is important that you know how to make a good crosswind landing. Advanced air fields in combat areas usually have only one runway. Frequently, the wind is blowing across it. Therefore, you must know how to land your airplane without exerting side loads on the gear, blowing a tire, or collapsing an oleo.

There are three possible ways to land crosswind:

1. Hold the airplane straight and level toward the landing strip, and drop one wing into the wind just enough to counteract drift.
2. Head the airplane into the wind enough to keep a straight ground path (crabbing).
3. Combine the first two methods.

The best method is the third—head into the wind and lower the upwind wing. This keeps you from dropping the wing too low or crabbing too much. It is easier to straighten the airplane when close to the ground. But remember to crab just enough to avoid slipping. Any uncoordinated movement may raise the stalling speed of the airplane.

Recognize the importance of the approach. Allow for drift on the turn into the approach so as not to overshoot or undershoot the approach leg. Correct for drift as soon as possible. The airplane should then be making a straight path to the landing strip and the only correction needed on actual landing is the angle of crab.

If there is only a moderate wind, use full flaps; in stronger winds, use less flaps.

As the airplane begins the flare out for landing, bring up the low wing and straighten the plane so there is no side load on the gear as it touches the ground. It may be necessary to kick the rudder hard to straighten the plane properly. Other controls available for keeping the airplane headed straight after landing are: cautious use of downwind brake, and smooth use of the upwind engine.

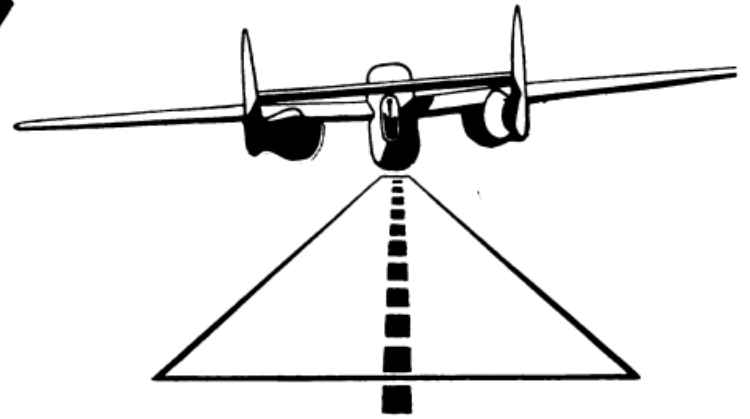

**UPWIND WING LOWERED**

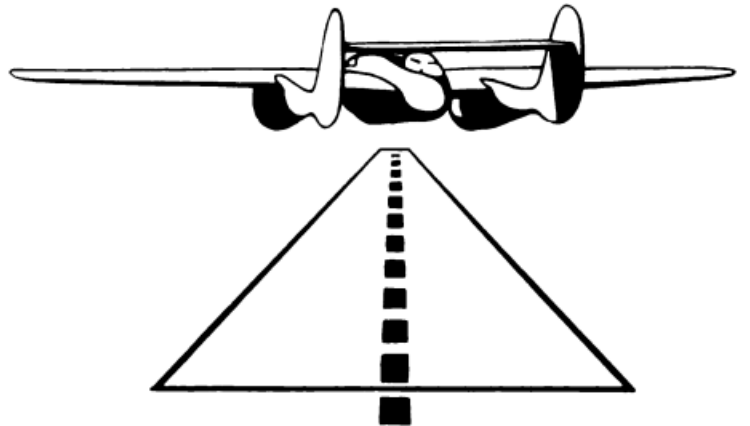

**CRAB INTO THE WIND**

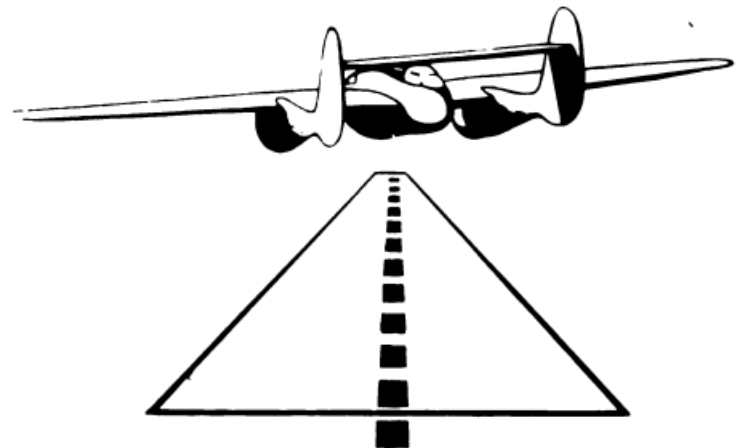

**UPWIND WING LOWERED  
CRAB INTO THE WIND**



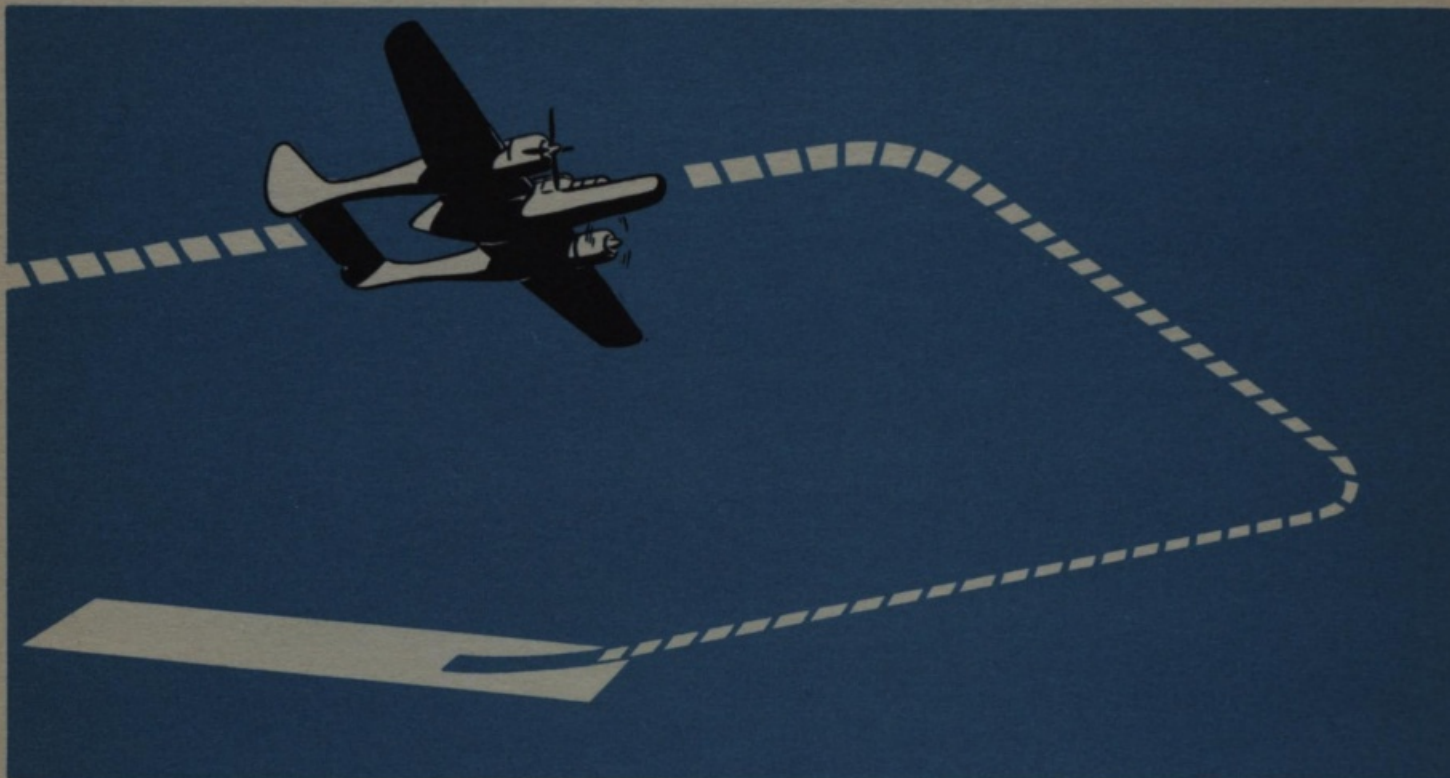

## SINGLE ENGINE LANDINGS

The P-61 handles remarkably well on one engine, but there are certain fundamental rules which should be applied to a single engine landing in any two-engine airplane:

1. Make the turns of your traffic pattern in the direction of your good engine, if practicable. It is entirely possible to turn in the direction of the dead engine, **provided you know how to do it**. Trim the airplane for straight and level flight, leaving a little rudder pressure on the side of the good engine. Be sure to keep your airspeed constant. Lose a little altitude on the turns, if necessary, to maintain critical single engine speed or whatever airspeed you may have above that minimum.

2. Be sure you have made a careful pre-landing cockpit check. You do not want to run out of gas on your one good engine.

3. Follow the normal traffic pattern, if possible. Under any circumstances, notify the control tower that you are coming in with a dead engine to make an emergency landing. Tell the tower the traffic pattern you plan to follow.

4. Lower the landing gear only after you

have turned in on the approach leg, and when you are sure you are going to make the field.

5. Lower the flaps not more than  $\frac{1}{2}$  when you are certain you are going to reach the field. In case there is danger of overshooting, lower the flaps all the way.

6. Keep only a small amount of power on the good engine. Make your approach as normal as possible. However, the airplane has the gliding angle of a streamlined brick and full flaps and no power and you may reach the field from quite a high approach. But put the plane on the ground and stomp on the brakes, even if you're doing 150 mph. Don't hold it off. It is better to hold a little rudder pressure into your good engine than to trim the plane to fly hands off with the power on. This prevents a sudden large change in rudder pressure when you cut the engine for landing.

If, through an error in judgment, you come in too fast, **go ahead and complete the landing even at 150 mph**. Don't try to go around on one engine, and run the risk of a stall near the ground. The good engine may quit, too.

## NIGHT LANDINGS

By the time you first fly a P-61, you will have flown at least 100 hours at night in a P-70. The two planes fly much alike, except that the P-61 is smoother and more stable. It also lands slower. Moreover, because of the P-61's greater flap area, the pitching motion is much more noticeable when flaps are lowered. Don't let this so disconcert you that you plow a new approach path through the tops of the trees.

Usually, you land without the use of wing lights. If you use them, never lower these lights when you're flying faster than 140 mph IAS. The normal procedure of night fighter squadrons is to land with the aid of a glide-path indicator and the runway lights.

Make sure you know what the glide-path indicator is and where it is located. It gives out three distinct color bands of light. The landing you make with its help is similar to an instrument landing. You are supposed to come in on

the green band of light.

If the airplane approaches on the yellow band, it is too high: if on the red band, it is too low. Learn how to follow the green band—keeping as near the center of it as possible—and make contact with the ground near the approach light. This insures clearing all obstacles in the approach path and leaves enough runway to complete the landing.

Remember, you must hold a constant rate of descent (about 500 ft. per minute) for the full distance of the approach. As you approach the glide-path indicator, and the runway lights begin to level out, decrease the speed and start a slight flare out. Then ease the airplane down to a tail-low landing.

It is easier to make blind approach beacon landings in the P-61 than in the P-70. The P-61's greater stability makes all instrument flying in it easy.



**Go-Around Procedure**

There are many reasons why you may have to go around after starting a landing. Whatever the reason, don't waste time debating with yourself. Level off, advance the throttles to climbing manifold pressure and raise the wheels immediately. Then, re-trim your elevators. The trim tabs are powerful, and if you don't re-set them as soon as you apply increased power, it is most difficult to keep the nose down. Your propellers already should be set at climbing rpm. Don't exceed recommended maximum airspeed—flaps down.

When you have sufficient altitude, raise the

flaps slowly and resume normal operations. Milk the flaps up gently. Remember that flaps change the lift of the wing and the attitude of the plane.

**Weight and Balance**

The P-61 is a Class 1B airplane, according to the definition of T.O. 01-1B-43. Accordingly, it is unlikely that it will be incorrectly loaded except under unusual circumstances. However, if you have any doubt at all about the loading condition of the plane, check the weight and balance chart. Obviously, you should know the gross weight and corresponding stalling speed of the plane you're going to fly.

**TABLE OF GROSS WEIGHTS AND CORRESPONDING CRITICAL SINGLE ENGINE AND STALLING SPEEDS**

<b>CONDITION OF AIRPLANE</b>	<b>GROSS WEIGHT (P-61B Weighs Approx. 350 Lbs. More)</b>	<b>CRITICAL SINGLE ENGINE SPEED (CLEAN)</b>	<b>STALLING SPEED (Flaps Full Down, Wheels Down, Rated Power (1600 Hp On Each Engine))</b>
Without gun turret, ammunition and external wing tanks	27,494 lbs.	120 mph	75 mph
With gun turret and ammunition, but without external wing tanks	29,007 lbs.	125 mph	78 mph
With gun turret, ammunition, and two 165-gal. external wing tanks.	31,077 lbs.	130 mph	85 mph
With gun turret, ammunition, and two 1000-lb. bombs	31,087 lbs.	130 mph	85 mph
With gun turret, ammunition, and two 300-gal. external wing tanks	32,969 lbs.	133 mph	87 mph
With gun turret, ammunition, and four 165-gal. external wing tanks	33,147 lbs.	133 mph	87 mph
With gun turret, ammunition, and four 310-gal. external wing tanks	37,091 lbs.	137 mph	95 mph

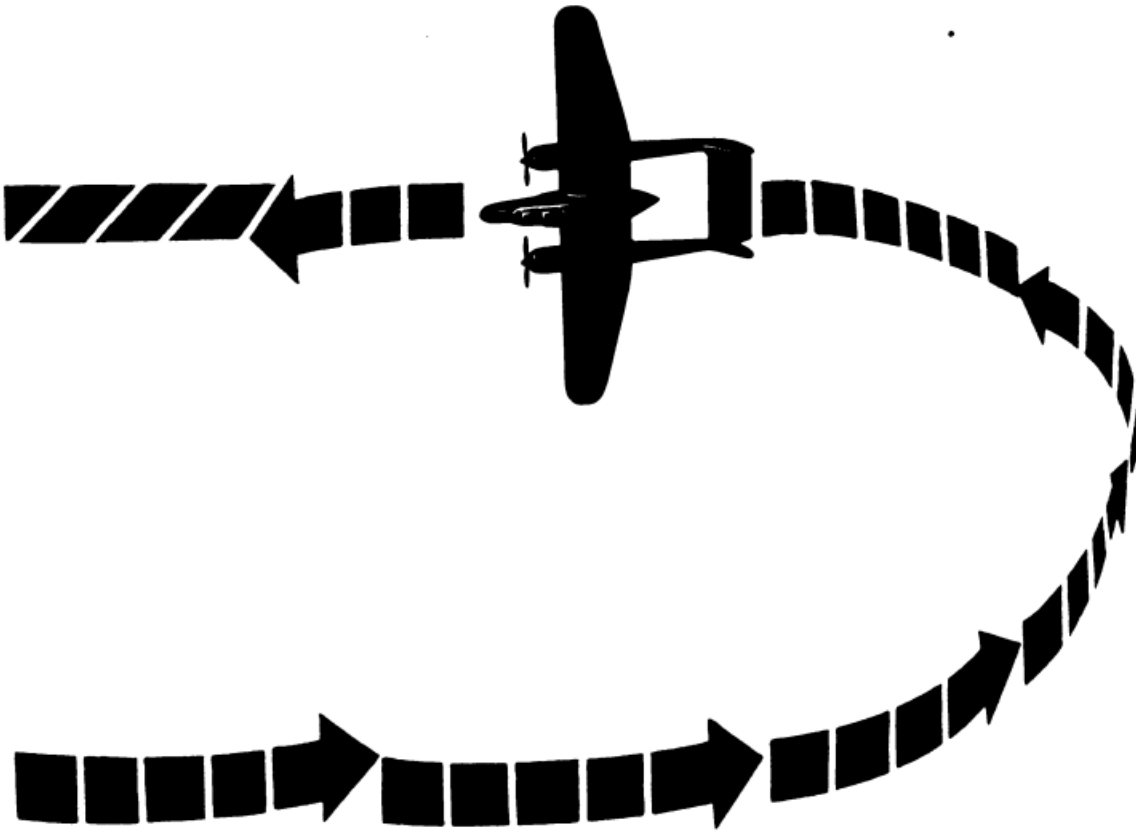

**MAKING A TURN  
BY A SERIES OF  
HIGHSPEED STALLS  
AND RECOVERIES**

## FLIGHT CHARACTERISTICS

As one pilot put it, "the P-61 is an honest airplane and extremely forgiving of pilot error." However, don't consider this an invitation to practice stalls at 1500 feet. You'd probably kill yourself on your first try. Foolhardiness in handling a P-61 ends in disaster as readily as it does in any other airplane.

The P-61's stalling speed is exceptionally low—75 mph IAS in a power stall with flaps and wheels down, and gross weight of 28,500 lbs. Its stalling speeds under various other conditions are listed on Page 66. However, as you know, stalling speeds vary slightly depending on how the plane is flown.

The P-61 gives you ample warning of an impending stall. It shudders and shakes like a jeep on a rough road.

The airplane recovers straight ahead from a stall. There is absolutely no tendency to fall off to one side or the other, whether the flaps and landing gear are down or up.

You can stall the P-61 at high speed in a turn. It has no tendency to whip either way. It does a series of stalls and recoveries while continuing to turn. One pilot, entering a 360° turn at 250 mph IAS, completed it in 25 seconds. He used the technique of letting the airplane repeatedly stall and recover all the way around the circle.

You can stall the P-61 safely with one propeller feathered or even windmilling and with full military power on the other engine. In this condition, the pilot must apply considerable rudder pressure to correct for the uneven thrust of the good engine. However, though the forces are high, he can hold this type of single engine stall without re-trimming the rudder tab. This makes the airplane safe, even if one engine quits during takeoff.

In a stall, the unconventional ailerons of the P-61 are still effective. The use of normal ailerons during a stall aggravates the condition.

# SPINS

It is extremely difficult to spin the P-61 and highly unlikely that any pilot will spin on approach or takeoff. It takes approximately 3/4 of a turn, with full elevator and full up rudder applied, to start spinning. At any time during the first 3/4 of the turn, you can recover immediately by relaxing pressure on either the rudder or elevator control. After two turns of a spin, however, recovery becomes increasingly difficult. But it still can be achieved by the normal method of sharply kicking the rudder against the spin, then applying full down elevator.

With the conventional ailerons, you need to exert firm rudder pressure to start a coordinated turn. That is because more drag is usually present on the side of the airplane that is being raised, causing it to yaw in the opposite

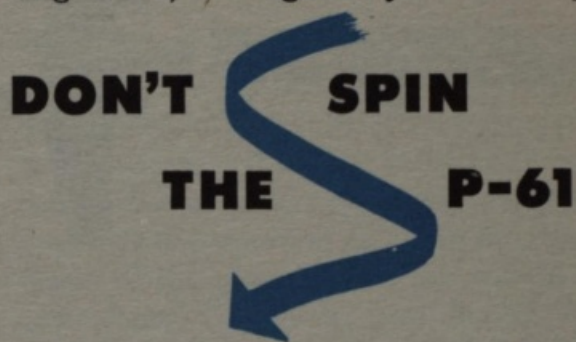

# AILERON PRESSURE

Because of the type of ailerons used on the P-61, the lateral control pressures are extremely light at all speeds. The ailerons of a P-70, at 250 mph to 300 mph IAS, feel as if they were nailed to the wing and banking the plane requires considerable effort. P-61 aileron control pressures are half as great at those speeds.

direction. With the spoiler type ailerons of the P-61, the wing on the outside of the turn is not disturbed. But the spoiler on the inside wing extends into the slipstream, causing drag and loss of lift. The size and shape of the spoiler cause it to furnish nearly the right amount of drag for any given turn. Because of this, you generally can make any turn, not violently executed, with your feet off the rudder pedals.



## CLIMBING

One recommended power setting for a medium climb is 37.5" Hg. manifold pressure and 2350 rpm in AUTO RICH position. To maintain this power, you must shift the blowers, depending on how high you're planning to climb. If icing conditions are present, however, and you have carburetor heat on, be sure to turn it off before shifting the blowers out of NEUTRAL. **If you don't, the engines may cut out.**

If you're going to climb only to about 10,000 feet, leave the blowers in NEUTRAL position. If you plan to climb to between 10,000 feet and 19,000 feet, shift them to LOW at about 9000 feet. If you expect to climb above 19,000 feet, shift the blowers to HIGH at about 18,500 feet.

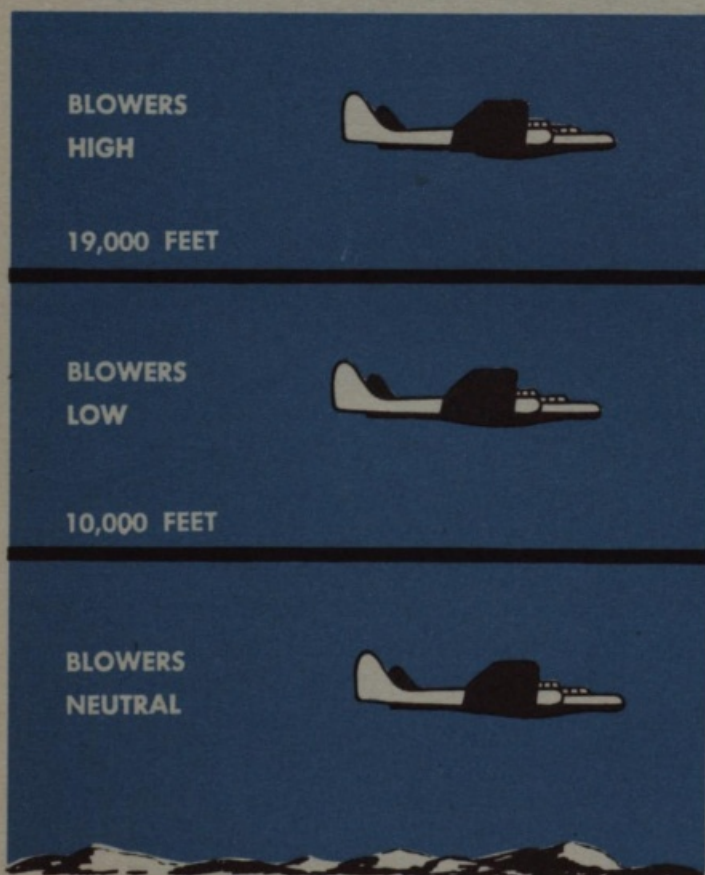

**Remember, the blowers steal horsepower from the propellers.** In LOW position, they use up about 200 Hp more than they do in NEUTRAL. In HIGH position, they use up approximately 350 Hp more than they do in NEUTRAL. Therefore, if you are going to climb to a height just under the point at which you normally would shift blowers, don't shift them, even when your manifold pressure seems a lit-

tle low. You'll gain more by letting the propellers have that extra horsepower.

### How to Shift Blowers

While you are learning to shift blowers from one position to another, the smooth way to do it is to shift them on one engine at a time. First, be sure the mixture is AUTO RICH. Then, move one blower handle in a swift, sure movement from NEUTRAL to LOW. Next, reduce manifold pressure to 29" Hg. and wait for the blower to shift. You will know when the shift is

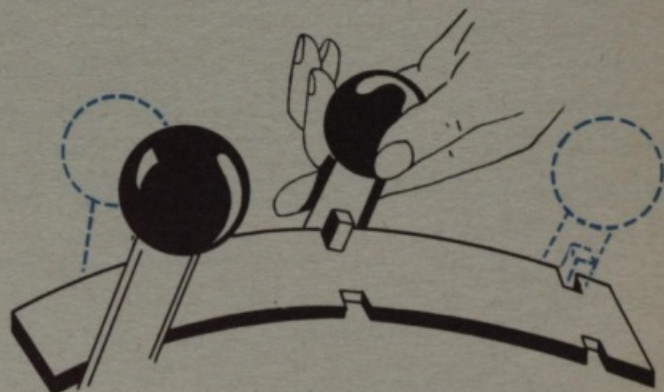

taking place, for the oil pressure drops and returns to a reading about 5 psi below its previous one. This reaction lags an instant or two behind the movement of the blower handle. At the same time, the manifold pressure tends to surge upward. Pull back the throttle to prevent it from exceeding the value you want to maintain temporarily. When the shift is completed, advance the throttle to the desired setting. Now, repeat the procedure with the other blower.

The shift from LOW to HIGH is done in the same manner. When you shift blowers, the engine blower does not change its gear ratio at all. In LOW position the auxiliary blower starts to operate; in HIGH position it speeds up.

When you have become more experienced, and certainly when you are flying in combat, you will shift the blowers on both engines at once. Usually the engines vary in the speed with which they shift blowers. It is even possible that one engine may cut out momentarily. You had better shift one blower at a time until you're used to the way they work.

Never fly for more than three hours in the P-51 without shifting blowers through the complete cycle from NEUTRAL to HIGH and back. This prevents sludge from accumulating.

# CRUISING

You obtain maximum range from your airplane at an altitude between 5000 feet and 7500 feet. To get this range, adjust the throttles to 35.5" Hg. manifold pressure, with AUTO LEAN mixture and NEUTRAL blowers. Or push them wide open, if you will not exceed 35.5" by doing so. If you are flying the P-61 without external wing tanks, adjust the rpm to maintain an IAS of 195 mph. The lowest practical rpm setting is 1450. If you are flying with external wing tanks attached, subtract 10 mph from the IAS for each pair of 165-gal. tanks, 20 mph for each pair of 310-gal. tanks. Similar variations would apply to medium-sized and large bombs.

The figures given for maximum range assume dropping the wing tanks in pairs as the gasoline in them is used. These figures also anticipate utilizing your last drop of fuel. **There is no margin for error.**

Don't drop empty 310-gal. tanks when you're flying faster than 200 mph IAS, or empty 165-gal. tanks at speeds greater than 355 mph IAS.

In order to stay up in the air as long as possible, for instance on patrol over an island or stooging around an enemy airfield, fly at an IAS of about 150 mph with 27" Hg. manifold pressure. Or use full throttle, if it doesn't cause the manifold pressure to exceed 27", in AUTO LEAN. Adjust your rpm from a minimum of 1450 to maintain this airspeed, and use whatever blower position is necessary for your alti-

tude. **But, avoid engine speeds of 1700 and 2000 rpm for continuous operation.**

For practically every other condition of cruising you meet, consult the complicated looking chart on Page 114. It looks complicated. Actually, it isn't. When you have studied the explanation printed opposite it, you'll find it easy to read the chart. It's a great help in planning missions. It tells you what your indicated airspeed, true airspeed, and fuel consumption will be at certain gross weights, power settings, temperatures, and altitudes. No printed list of combinations of these factors is adequate for future use when you've become an expert P-61 pilot.

However, this cruising chart reflects a primary desire to prolong the life of the engines as much as possible. The power settings it recommends involve the use of somewhat more fuel and oil than the engines actually need to operate efficiently. In order to make more efficient use of your engines, you may sometimes want or need to increase as much as 3" the manifold pressure readings which the chart suggests, without increasing the rpm. You won't exceed safe pressures inside the cylinders if you do this.

Note that this has been done in the following examples, taken from the chart. They show how fast the P-61 will fly and how much fuel it will consume while cruising economically at two different weights and two different altitudes but with a constant power output and AUTO LEAN mixture. For cruising, always use AUTO LEAN mixture below 2230 rpm and 35" Hg. manifold pressure.

GROSS WEIGHT	IAS	TAS	FUEL CONSUMPTION	ALTITUDE	MANIFOLD PRESSURE	RPM	BLOWERS	TEMP.
27,000 lbs.	220 mph	257 mph	130 gals. per hour	9,000 feet	31.5" Hg.	1850	NEUTRAL	-3° C
28,500 lbs.	216 mph	253 mph	130 gals. per hour	9,000 feet	31.5" Hg.	1850	NEUTRAL	-3° C
27,000 lbs.	203 mph	260 mph	135 gals. per hour	16,000 feet	32.5" Hg.	1850	LOW	-15° C
28,500 lbs.	199 mph	256 mph	135 gals. per hour	16,000 feet	32.5" Hg.	1850	LOW	-15° C

GROSS WEIGHT	IAS	TAS	FUEL CONSUMPTION	ALTITUDE	MANIFOLD PRESSURE	RPM	BLOWERS	TEMP.
27,000 lbs.	180 mph	270 mph	141 gals. per hour	25,000 feet	29" Hg.	1975	HIGH	-18° C
28,500 lbs.	175 mph	265 mph	141 gals. per hour	25,000 feet	29" Hg.	1975	HIGH	-18° C

See what happens at a higher altitude. In order to continue obtaining a TAS of between 255 mph and 270 mph, at 25,000 feet it is necessary to change the airplane's power setting.

**Oil and Cylinder-Head Temperatures**

You have already been warned of oil and cylinder-head temperatures which you must not exceed while climbing the P-61. Oil and cylinder-head temperatures are a factor of importance in cruising, too. In fact, they are of more lasting concern to you then, because of the far greater length of time you are cruising.

You have learned that your airplane flies faster if you keep the oil cooler flaps and cowl flaps closed. However, to do so causes your oil and cylinder-head temperatures to rise. It harms the engines and creates frequent maintenance problems if these temperatures are al-

lowed to exceed certain maximums. For continuous operation, those **maximum temperatures** are 85°C for the oil and 232°C for the **cylinder heads**.

Make your engines last longer and preserve cordial relations with your crew chief by opening the oil cooler flaps and cowl flaps just enough to keep the oil temperature at about 75°C and the cylinder-head temperatures at approximately 190°C. It is far better to coddle the engines and arrive 5 minutes later than you wanted to, than to achieve maximum cruising speed at all costs.

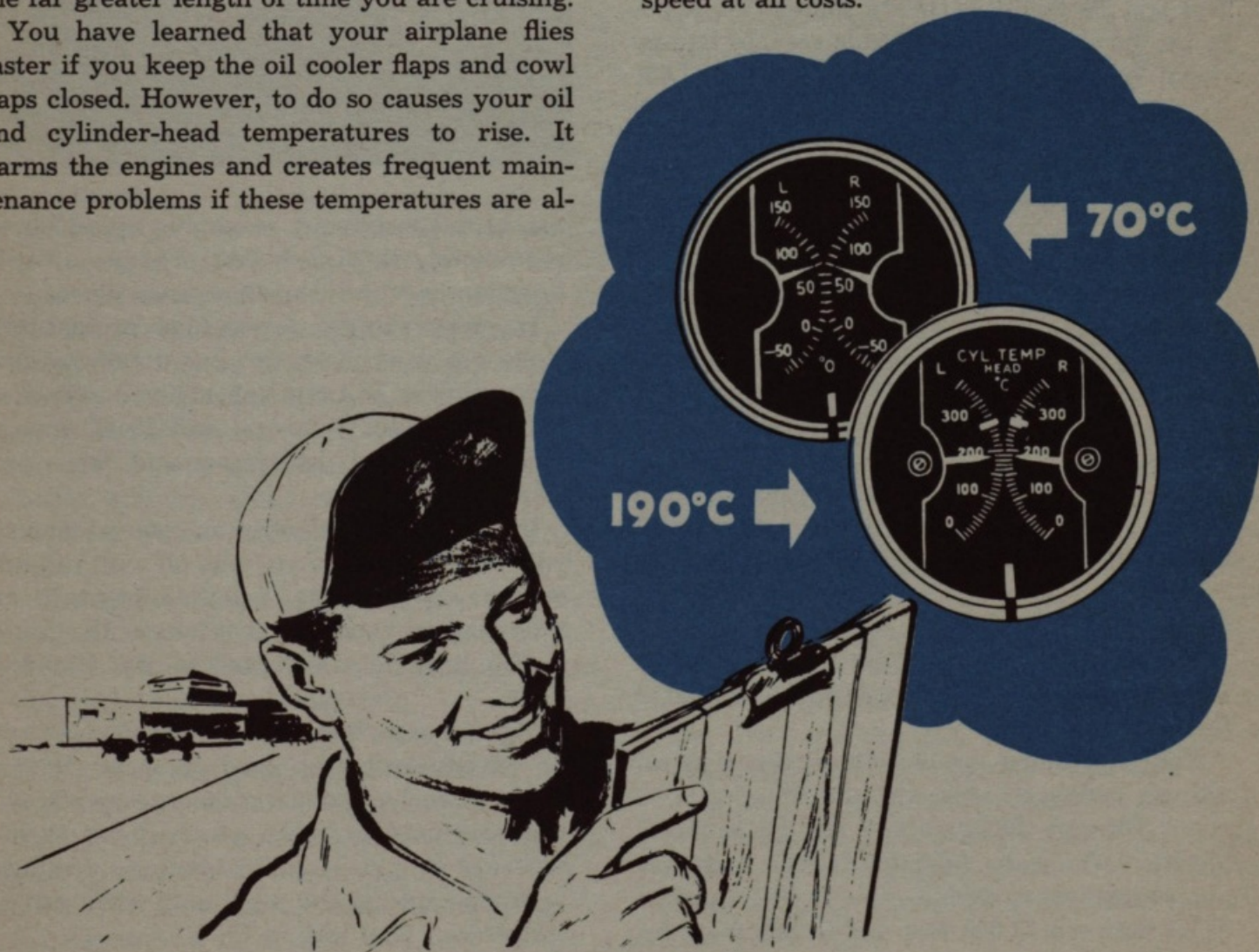



## DIVES

The P-61 does not pick up speed as rapidly in a dive as a P-38 or P-51. It dives quite like the P-70, except that elevator pressures are less noticeable, because of the spring tab. The airplane has been dived at 425 mph IAS, at 25,000 feet. It handled normally at this speed. There was no hint of compressibility. In combat, the plane has been dived at considerably greater indicated speed at lower altitudes.

But don't try diving the P-61 that fast yourself. **Your permissible limit is 415 mph IAS and 3060 rpm.** That's at altitudes below 10,000 feet. Don't exceed 375 mph IAS in dives between 10,000 and 20,000 feet. Don't dive faster than 305 mph IAS at altitudes between 20,000 feet and 30,000 feet.

If you **do** encounter compressibility in a dive, continue straight down to 18,000 feet or 15,000 feet and start your recovery there. This is because the plane at that altitude reaches its terminal velocity at a little above 425 mph IAS. From that point on, the plane's TAS decreases even though its IAS continues to rise.

### Prohibited Maneuvers



The following maneuvers are prohibited in a P-61: normal spins, inverted spins, snap rolls, outside loops, and inverted flight.

### Maximum Performance

Suppose you are in a tight spot in combat. What is the utmost you can get out of your P-61?

Your maximum speed in level flight, at an altitude between 21,000 feet and 23,000 feet, is about 375 mph TAS, without the use of water injection. The water injection feature increases the horsepower of each engine by 10%. At altitudes between 21,000 feet and 23,000 feet, the

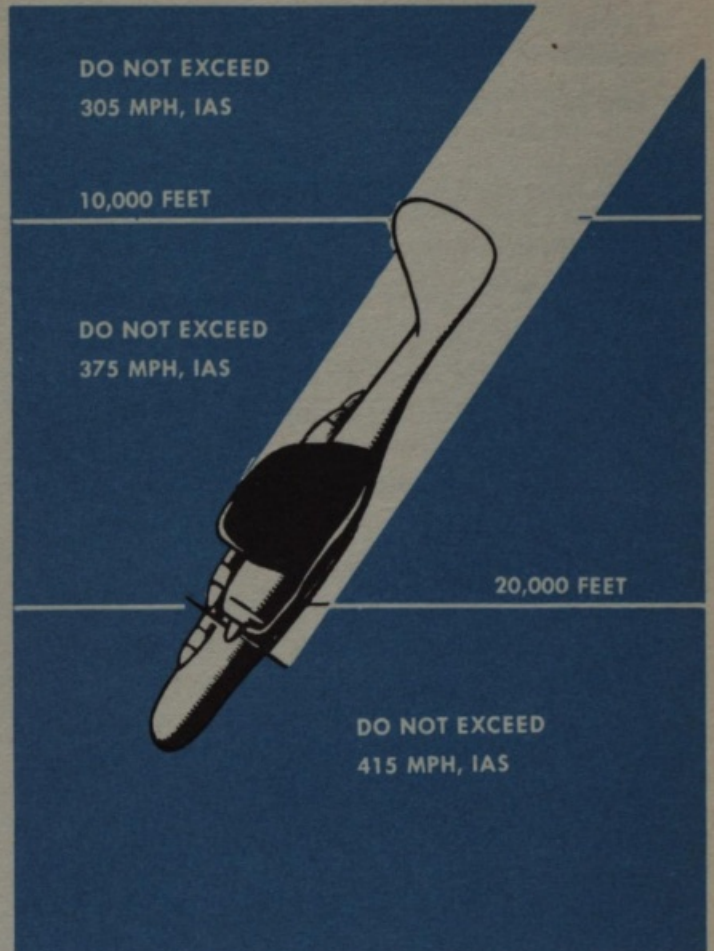

use of it boosts your maximum speed by approximately 15-20 mph TAS. The use of water injection provides **war emergency power**.

If you're saving your own hide, you naturally don't worry much about oil and cylinder-head temperatures. But **remember**: if you exceed the maximums (100°C for oil and 260°C for cylinder heads), you lose power and defeat your own purpose.

If you're taking off after an enemy plane and you're really in a hurry, take off with **full military power** (54" Hg. manifold pressure and 2700 rpm) and maintain it as long as 15 minutes, if you have to. **Don't exceed the 15-minute limit.**

**Maximum performance** of your airplane must be saved until you need it most. Reserve strength, such as your war emergency power, is like ammunition. When you're away from a source of supply, in enemy territory, you hoard your ammunition and use it only when you can make every shot tell.

## ACROBATICS ARE FORBIDDEN IF...

**RADAR IS INSTALLED**

**WEIGHT EXCEEDS 28,000 LBS.**

**WING TANKS ARE CARRIED**

## ACROBATICS

If there is anything that makes your radar maintenance man unhappy it is to have you do acrobatics in a night fighter while the radar equipment is in it. That equipment is delicate and hard to maintain. Furthermore, it is of the utmost importance to the effectiveness of your airplane in training missions and in combat that its radar be in perfect working order.

Accordingly, there are three firm limitations to the performance of acrobatics in a P-61. **Acrobatics are forbidden** if radar equipment is installed, if the gross weight of the airplane exceeds 28,300 lbs. (its normal weight with gun turret installed); and if it carries wing tanks. If wing tanks are attached you should think enough of your own skin to avoid doing acrobatics, anyway. Don't even make tight turns or sharp pullouts when you're carrying wing tanks.

Except for these restrictions, you can safely perform the following maneuvers: half roll, slow roll, barrel roll, normal loop, Immelmann, chandelle, and intentional stall.

However, you must keep one fact constantly in mind. Don't attempt **any** maneuvers until you have a comfortable margin of altitude. The P-61 is a heavy airplane and loses altitude rapidly if mistakes are made.

Yet, the P-61 is amazingly maneuverable for an airplane of its weight and size. It does a

**normal half roll**, either pulling through in a split S from the upside down position or rolling back to level flight. **It is not safe to do the split S at less than 12,000 feet altitude when your initial speed is 220 mph IAS or more.**

The P-61 rolls easily and you can roll it unusually slowly. Don't ever attempt to do a **slow roll** at more than 350 mph IAS. The best speed for this maneuver is about 260 mph IAS.

Start the **normal loop** at about 375 mph IAS. Don't pull the plane in too tight to begin a loop—just to a couple of G's. At the top of the loop, you should be doing about 125 mph IAS. If your first few loops in the P-61 are marred by stalling out upside down at the top of the loop, don't be alarmed. You recover from an upside down stall much in the same way you recover from a normal stall. First, cut the power. Let the nose drop down and the plane regain airspeed. Pull through in a split S or roll back to level flight.

Of course, you may still prefer to recover from your stalls in a sitting rather than a hanging position. If so, you may roll the plane over by using the ailerons, while it is still stalled. Then, recover from the stall normally.

If you stall in an unusual position during any acrobatic maneuver, cut the power and let the nose of the plane drop. In this way you regain both flying speed and composure with the least amount of effort.

# HALF ROLL

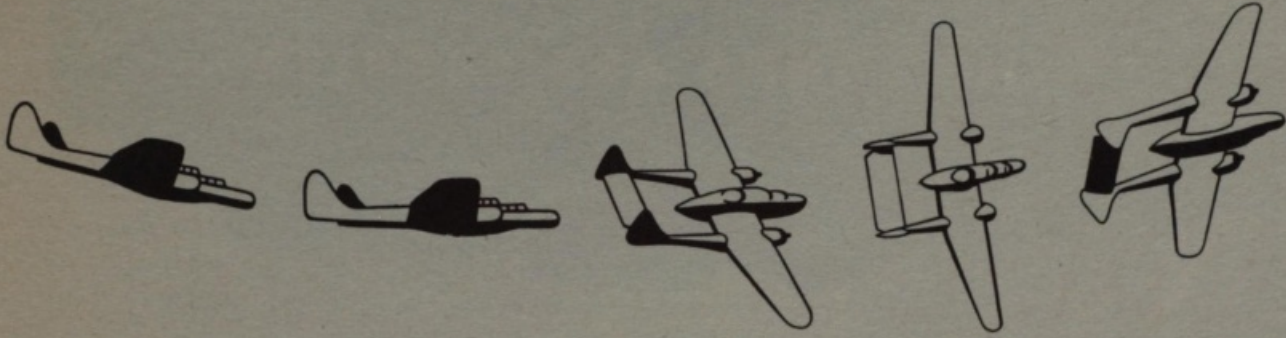

# SLOW ROLL



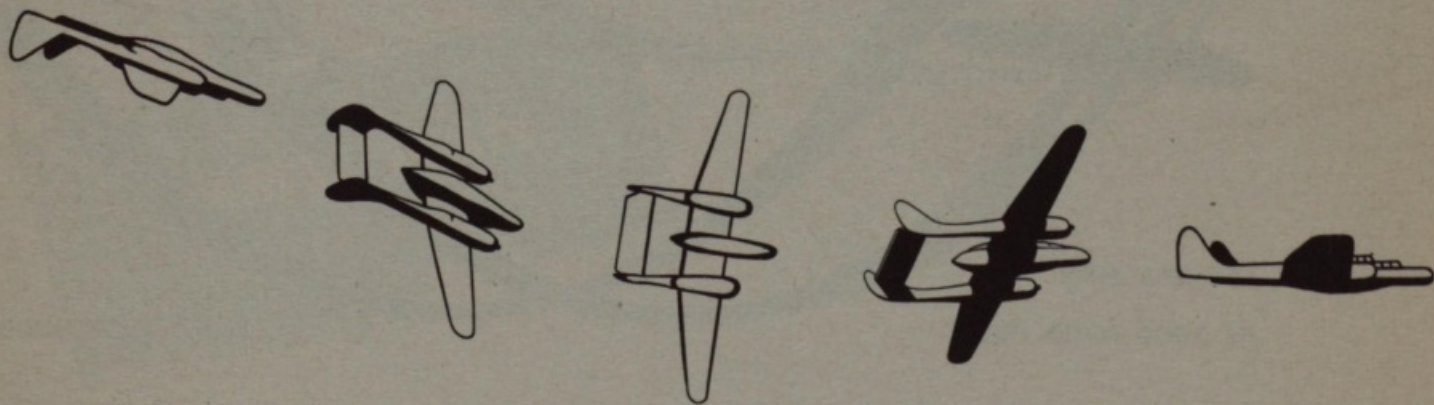
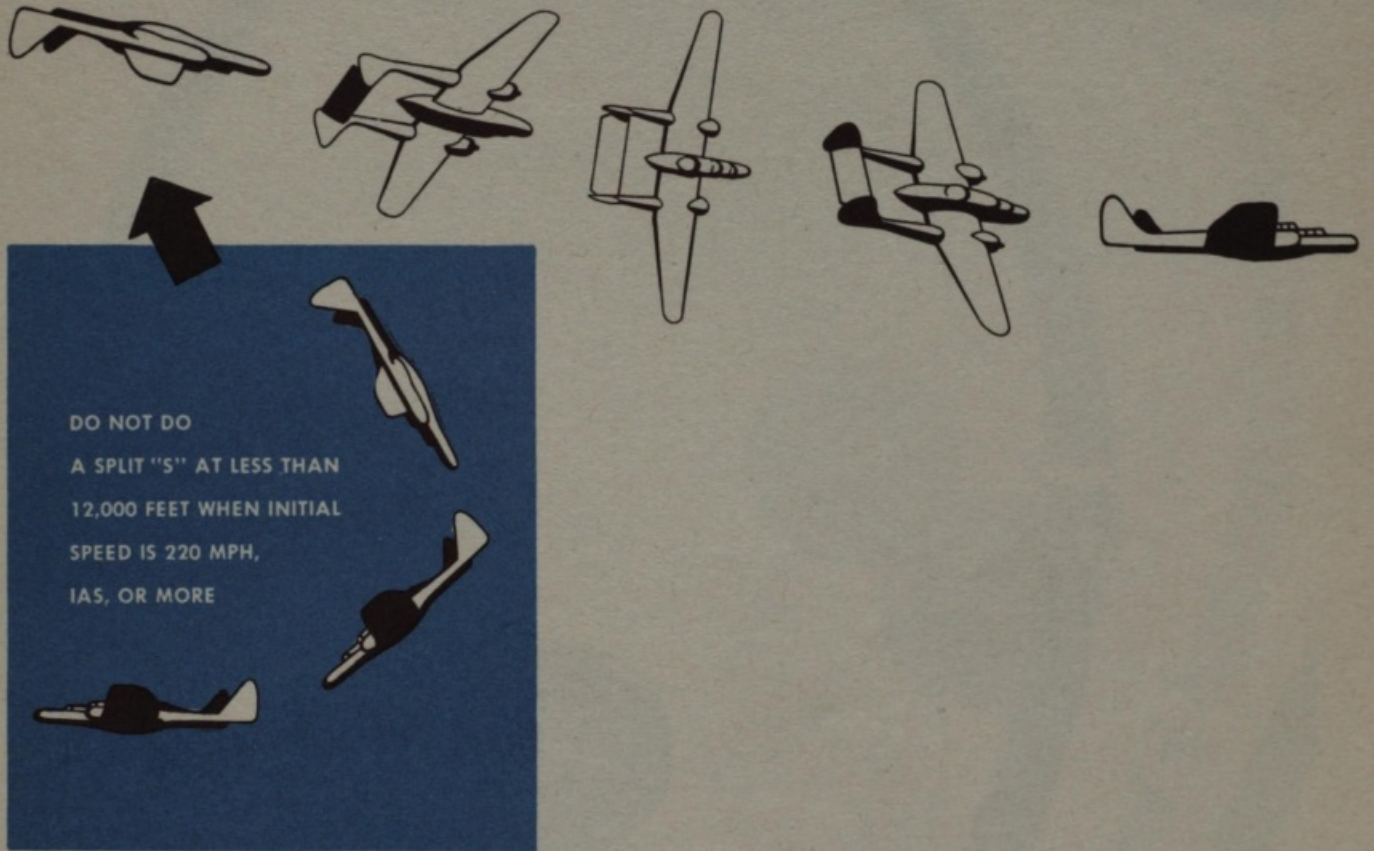

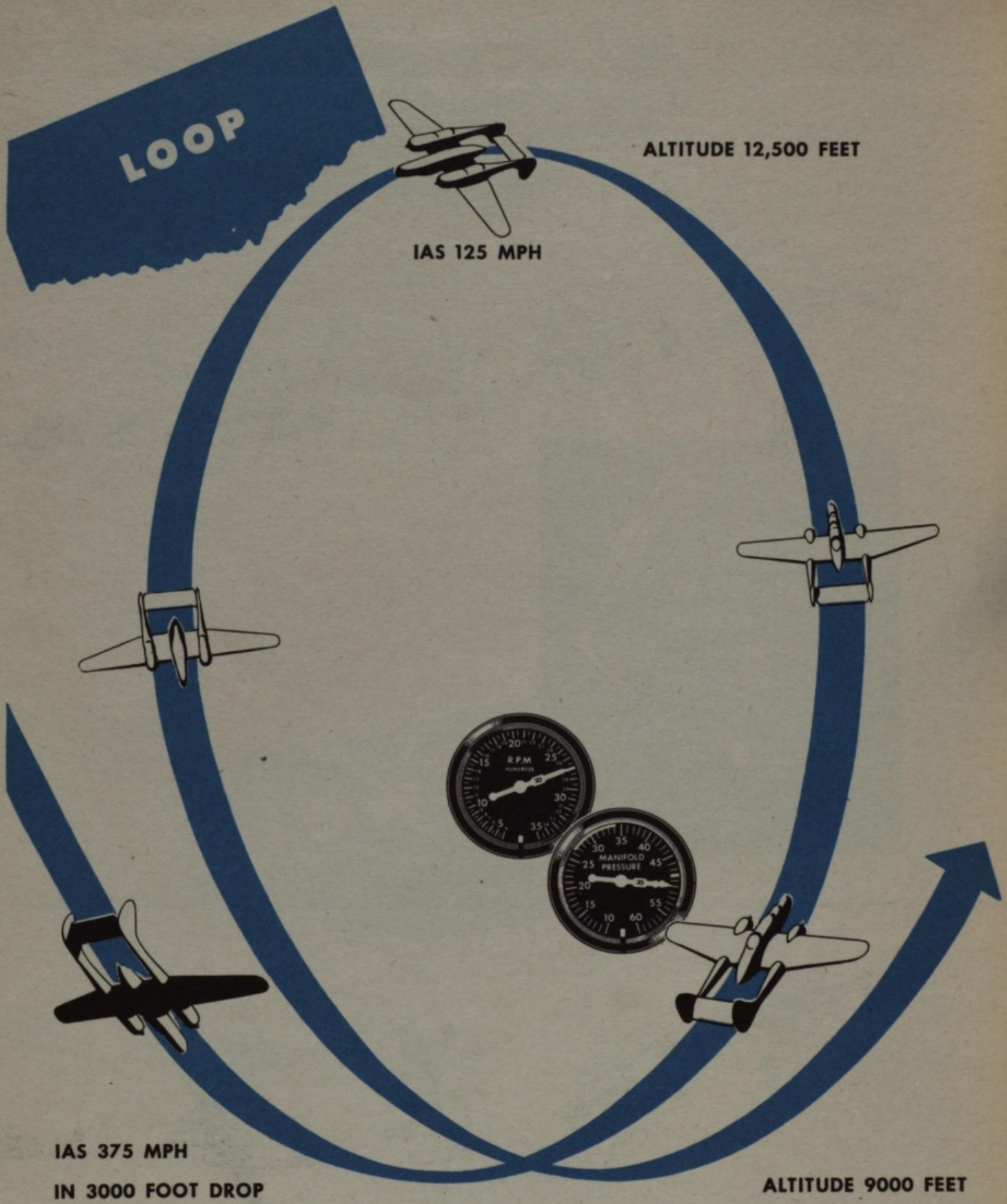

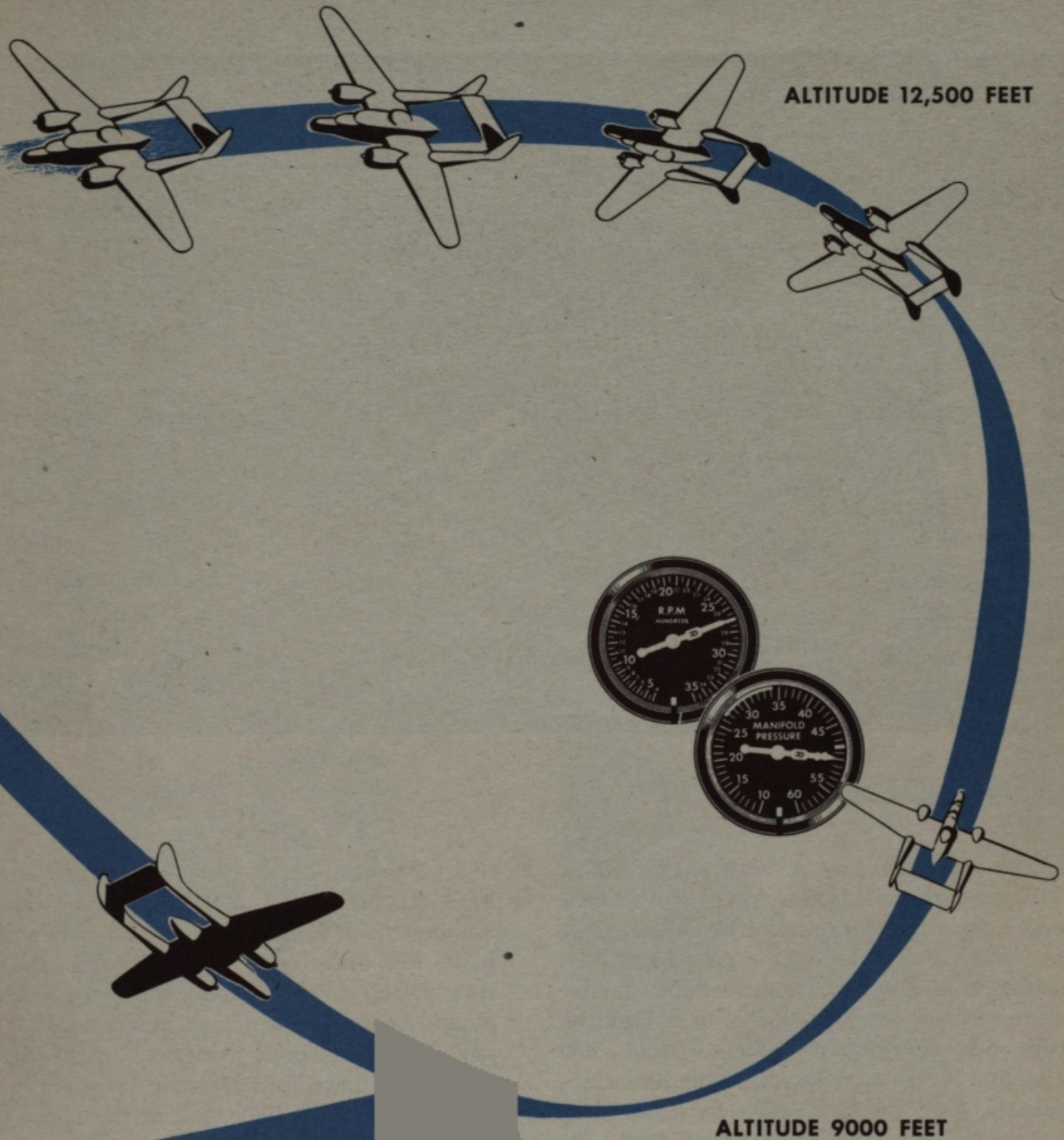

**IMMELMAN**



## INTRUDING

Aerial night fighting is only partly defensive. The nearer our ground forces move to the enemy's principal bases and inner defenses, the more action the night fighter pilot sees, over beachheads and newly taken airfields. As we close in on the enemy, he is able to strike back harder and more frequently than he could when we lay at a far greater distance from him. Consequently, each forward move we make must be protected by a cover of night fighters. To that extent, they are used defensively.

Intruding, on the other hand, is a phase of aerial night fighting which is definitely offensive in character. Yet it is not limited to use when the enemy is being driven before advancing infantry. For instance, early in the Battle of Britain, British intruders flew out to hover over German night bomber bases and attack the planes as they entered the traffic patterns of their home fields. That is a favorite game of

night fighters. They sneak in over an enemy base, staying out of sight and hearing but remaining near enough to watch the field, note lights and other signs of activity there. Then, they swoop down and knock off the enemy's planes as they return from missions. It is reported that a single American night fighter plane shot down four German bombers in the traffic pattern of their field in the space of a few minutes one night.

But intruding covers many phases of offensive aerial fighting besides the type described above. It includes strafing trains and supply vehicles at night, shooting up and bombing ships, bombing airport facilities, ammunition dumps, and other installations vital to the enemy.

One situation in which you must know how to get the maximum endurance out of your plane is while stooging around an enemy air-

field, waiting for the targets to come home. That is when a knowledge of how to read your cruising chart pays big dividends. You must fly slowly and at exceptionally low altitudes to avoid attracting attention. It is essential to use the lowest possible rpm in order to conserve fuel and keep engine noise to a minimum.

If your airplane is equipped with a radio (absolute) altimeter, it is on such a mission as this that you can use it to best advantage. In case your P-61 does not have an absolute altimeter, make yourself thoroughly familiar with the altimeter correction chart on Page 112. This chart shows you how much error there is in your barometric altimeter at various indicated airspeeds.

**Gunnery**

Assume you are starting out on a typical practice gunnery mission in a P-61. If your gunner is not going with you, turn on the fire selector switch for the gun turret to PILOT before you take off.

When you are ready to fire at the target, turn on the cannon relay switch on the generator

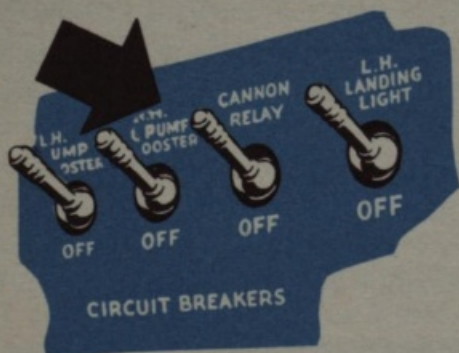

panel. Your gunsight won't work until you have done this. Now, turn the camera switch on the electrical panel to COMBAT. (When this

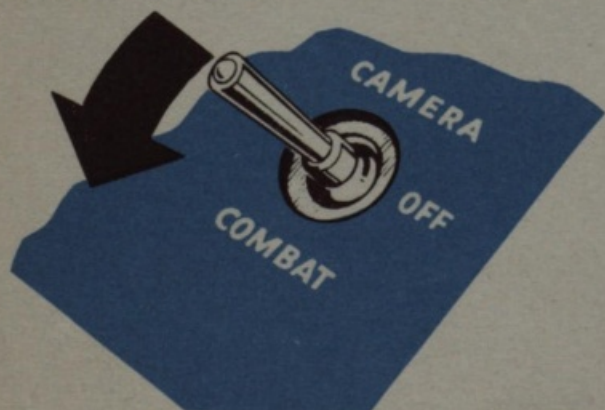

switch is in the OFF position it acts as a safety for all guns.) Adjust your gunsight to the desired brilliancy by turning the rheostat at the bottom of the electrical panel



Fire the guns with the button (on top) and the trigger (underneath) at the righthand side

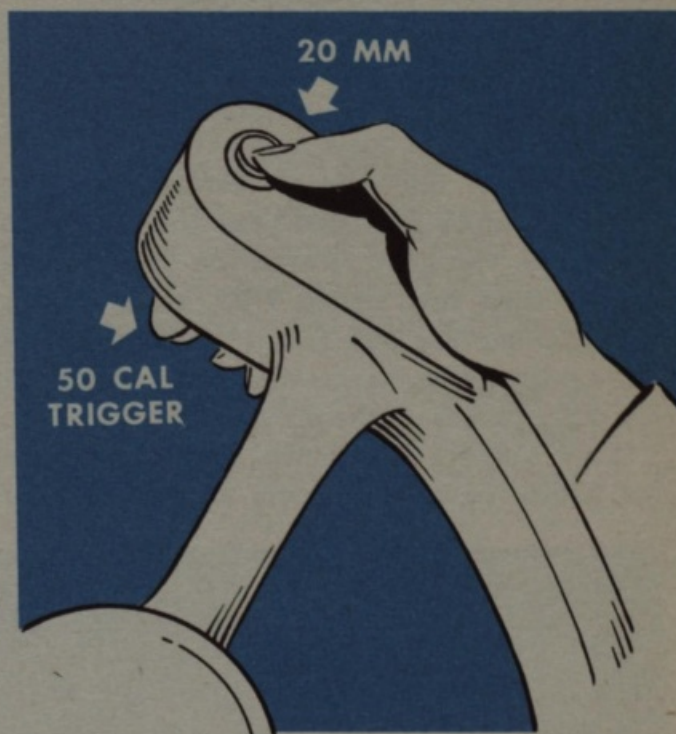

of your control wheel. Because of the noise of the engines, the guns sound like the sputter of an outboard motorboat. The cockpit temporarily fills with smoke from the firing but quickly clears. At night, the flashes from the turret guns, when fired in the forward position, are as blinding as lightning. However, the pilot cannot see the flashes from the 20 mm. cannon in the belly of the airplane.



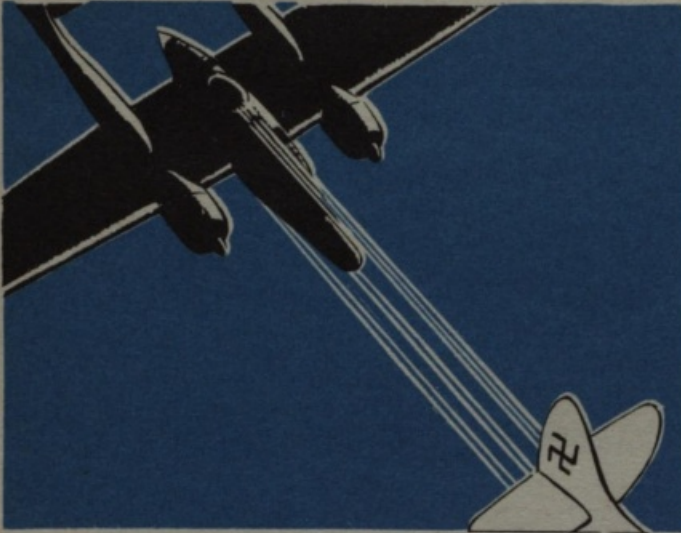

You can fire the fifties and twenties together or separately. The fifties fire faster and more evenly. Because the P-61 is an especially heavy airplane, firing the guns has little effect on its speed, although it shudders noticeably.

Don't overheat the guns by firing long bursts. You are more likely to ruin the guns than to run out of ammunition quickly. The P-61 carries an unusually large supply.

**Don't turn the camera (safety) switch to COMBAT until you start your pass at the target.** When you have cleared the target, **immediately turn this switch OFF** until you are ready for another pass. If you leave the guns on, there is always a chance of shooting up some of the other planes on the mission with you.

When you are in a combat area and shooting for keeps, have your guns all ready to fire

whenever you are anywhere near the enemy.

If your P-61 is equipped with night binoculars, you may use them as a gunsight—**at night, preferably.** Use these binoculars with caution on ground and aerial practice missions in the daytime. They change your depth perception drastically and you may fly into the target.

Some P-61's are fitted with bomb racks, either two or four. You may carry fuel tanks or bombs on those racks, depending on your mission. Each rack can carry a 310-gal. tank or a 1,600-lb. bomb. The release switches are so arranged that you can drop from one to four tanks or bombs at a time.

It isn't practical to do high altitude precision bombing with a P-61 or any other fighter plane. If you fly the P-61 on bombing missions, you will probably do either glide or skip bombing.

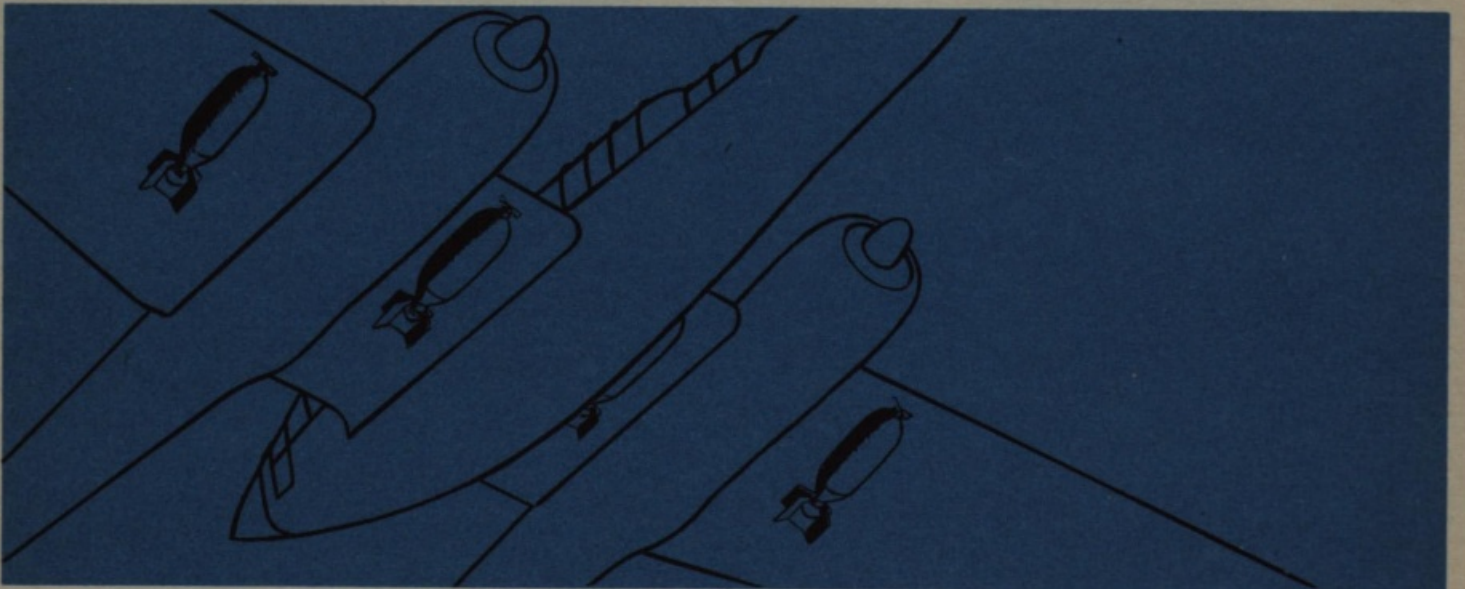

NIGHT

ADAPTATION



The average pilot doesn't need to eat a carload of carrots to see well in the dark. His night adaptation is normally adequate without special diets. However, if there has been a decided lack of vitamin A in the food he eats, his night vision will be inferior. If he eats the eggs, butter, cheese, liver, apricots, peaches, carrots, squash, peas, and whatever greens he is served at mess, he has nothing to worry about.

You may accomplish night adaptation in two main ways: by staying for about half an hour in a completely dark room before takeoff, by wearing night adaptation goggles with red lenses. Don't permit any white light to leak around the edges of these glasses. A third method is to

stay in a room lighted only by a dark red bulb. This is the least satisfactory way of obtaining night adaptation.

The use of red lensed goggles is the best. It is most convenient, doesn't interrupt your poker game, and by remaining in the dark, without the glasses, for an additional 5 minutes before taking off you can make your night adaptation complete.

It is possible for one eye to be night adapted while the other isn't. It's a disturbing sensation but an important fact to know. For instance, if you have to use a flashlight to look at something in the cockpit while flying at night, first close one eye. Save its night adaptation for use when

WEAR RED GLASSES

5 MINUTES  
IN THE  
DARK  
BEFORE  
TAKEOFF

## RESTRICTED

you switch off the flashlight. If you encounter lightning on a night flight, fly with one eye shut. When caught in searchlight beams, use only one eye to read your maps and instruments, and use it sparingly. Also, when you fire your turret guns in the forward position, keep one eye closed while you sight the target with the other one. The flash of these guns is as brilliant as lightning.

You can quickly discover how important it is to preserve night adaptation in one eye by trying a simple experiment. Sit in a dark room long enough for both eyes to become thoroughly accustomed to the lack of light. Then, while you put a hand firmly over one eye, leave the other eye open and turn on a bright light for about a minute. Switch it off. Look around the room. You can't see a thing. Now, shift your hand and open the night adapted eye. You can see almost as well as you could with both eyes before the light was turned on.

Miners have long recognized the importance of keeping at least one eye constantly adapted to the dark. They even put blinders over one eye of their mules when the animals leave the pits for a short time so they can readily find their way when they go back into the mine.

Once you are flying your airplane at night, there are certain precautions to take which will help preserve your night adaptation:

1. Keep all unessential lights in the plane turned off. Dim the lights you have to use.



82

2. Use red light in the plane whenever you can. Put a red lens in your flashlight.

3. Read instruments, maps, and charts rapidly; then look away. Better still, use one eye.

4. Wear your oxygen mask from the ground up on all night missions, practice or combat.

5. Keep goggles, enclosure windows, and windshields clean and free from scratches. Scattered or reflected light reduces contrast between faint lights and their backgrounds.

6. In the dark, look to one side of the thing you want to see. Remember, at night you can't



see what you look at directly. A night blind spot lies at the center of your eye.

7. Move your eyes slowly back and forth across the field of vision. Then the image of what you want to see is more certain to register. Often you can see more efficiently simply by shifting your gaze a few degrees. You can do this more easily by moving your head slowly then by moving your eyes alone.

RESTRICTED



## RADIO AND RADIO NAVIGATION

Radio equipment is of the utmost importance in aerial night fighting but it is primarily the concern of the radar observer. Furthermore, information about it is classified as confidential or secret. We cannot include such information in this book. You will learn all you need to know about it during your night fighter training.

However, there is other radio equipment in the PFI which you must know how to operate. There are eight channels of VHF with which you communicate with the ground control. There are also very high frequency beam receiver and an interphone system. There is special radio equipment SCR-585, which identifies your airplane in flight. In some PFI's, in addition, there are a radio compass and a radio altimeter.

Your SCR-522 equipment, commonly called VHF, is in constant use. The controls are located on the right side of the pilot's compartment. One of these radios is the command set, and the other is the liaison set. The position of

the switch on the aluminum jack box determines what radio you use.

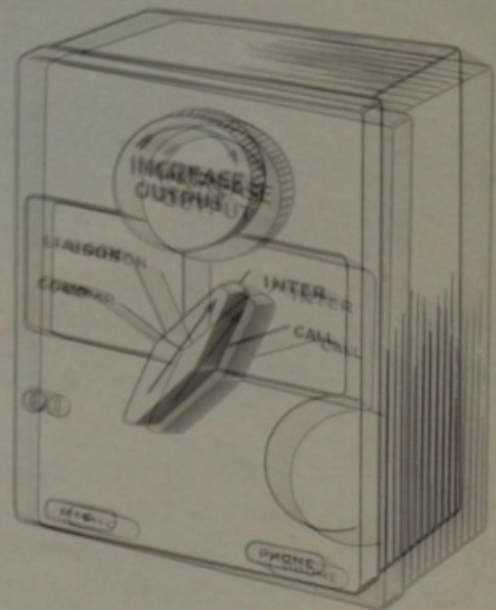

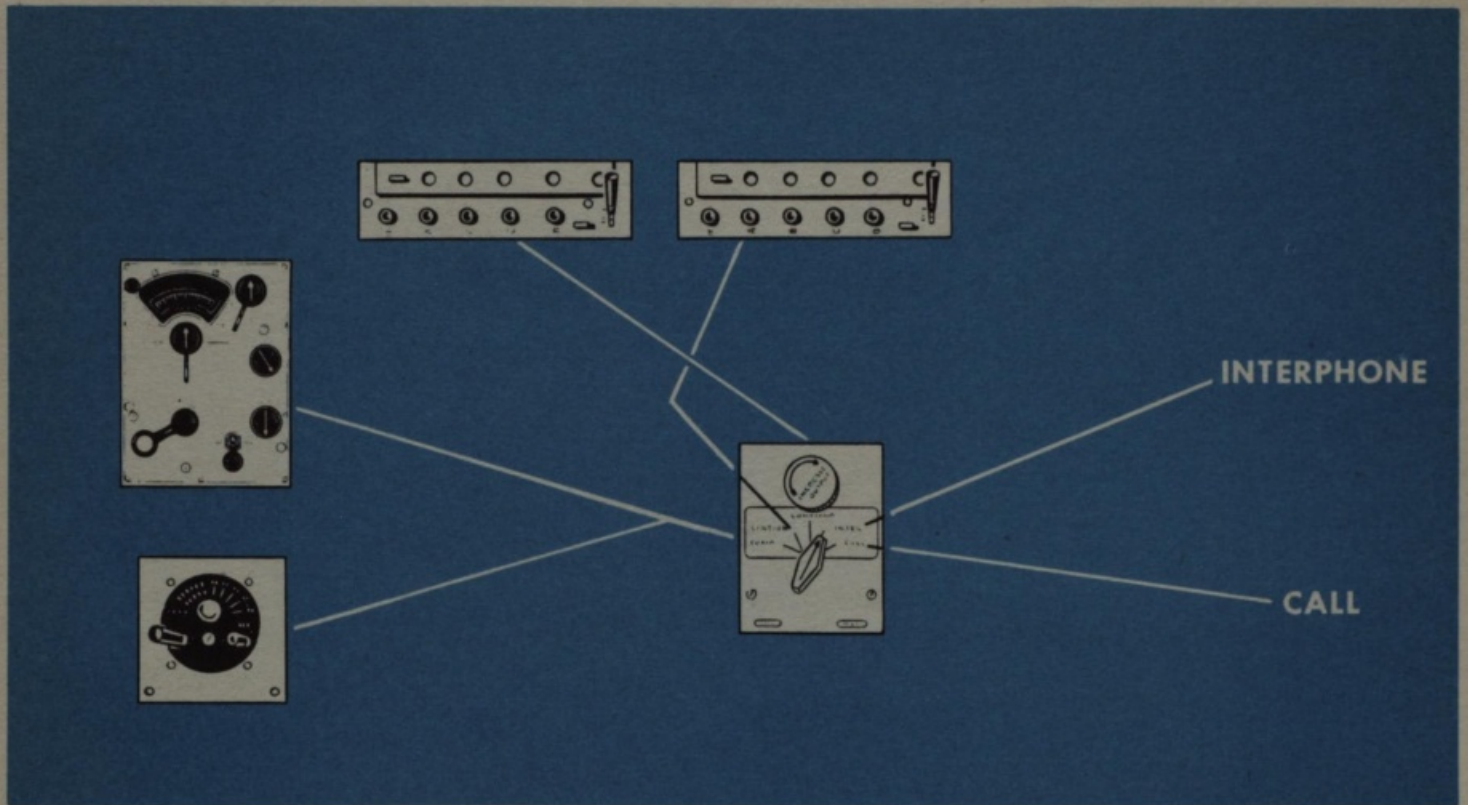

**VHF Equipment**

To operate the VHF equipment, all you need to do is press the push button controlling the channel you want to use. To talk to a ground station, push the RADIO button at the left-hand side of the control wheel.

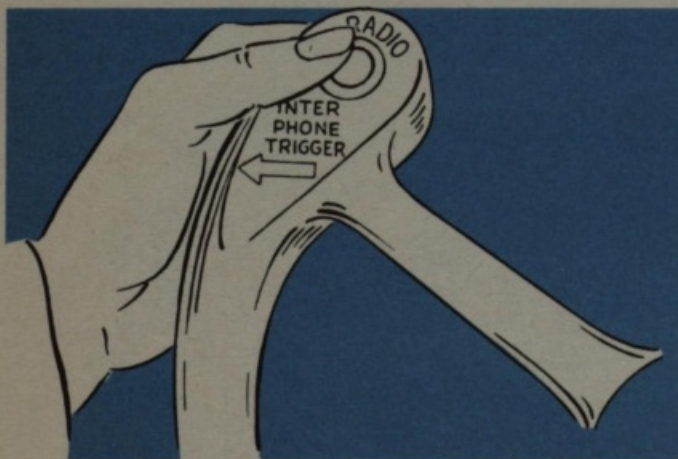

Before starting any mission, test the homing channel to see that it is operating. Too many pilots have waited until they were lost to find out their homing channel was dead.

Give the homing station plenty of practice in bringing you home. This builds up your confi-

dence in the equipment and improves the homing station's efficiency.

Remember, if you cannot raise the ground control or homing station the first time you call, climb to a higher altitude and try again. VHF radio waves travel in a straight line. The curvature of the earth or obstructions such as mountains and high buildings make it impossible to contact ground stations if you're too low.

Your small Detrola set receives only American beam stations and control towers operating in a range of 200-400 kilocycles. You can hear the beams and towers with this radio, but you can't talk to them with it.

To use the Detrola set, first turn the jack box switch to COMPASS. Then, turn the volume control knob on the face of the Detrola set to the right. This turns on the radio. **Don't forget there is a circuit breaker for this radio on the generator control panel. This must be on first.**



**Radio Compass**

If you wish to use the radio compass, first turn the jack box switch to COMPASS. Then, turn the compass control switch from OFF to COMPASS. Set the tuning control to the station desired and turn the airplane until the compass needle centers itself. You then can home on that station.

Check to make sure you are not flying directly away from the station rather than directly towards it. If you are headed towards the station, as you turn left the compass needle moves to the right, and vice versa. If you are flying away from the station, the compass needle swings in the same direction you turn the plane. As you pass over a station, the compass needle first fluctuates rapidly, then swings

as far to one side or the other as it can go. As you fly away from the station, the needle once more functions normally, except that the indications are the reverse of those given you as you approached the station.

Reduce the sensitivity of the radio compass indicator enough to prevent the needle from swinging wildly when the airplane turns only a few degrees off course. Do this by turning the knob marked COMPASS to the left. If, on the other hand, the needle responds sluggishly to turns, increase the sensitivity of the indicator by turning the COMPASS knob to the right.

If you are in any doubt about the proper procedure for using the radio compass or beam receiver, read Technical Orders 30-100A-1, 30-100B-1, and 30-100F-1. These are the T.O.'s on Instrument Flying. Read them frequently.



◆ IF YOU ARE FLYING TOWARDS STATION, COMPASS NEEDLE SWINGS OPPOSITE TO DIRECTION OF TURN.

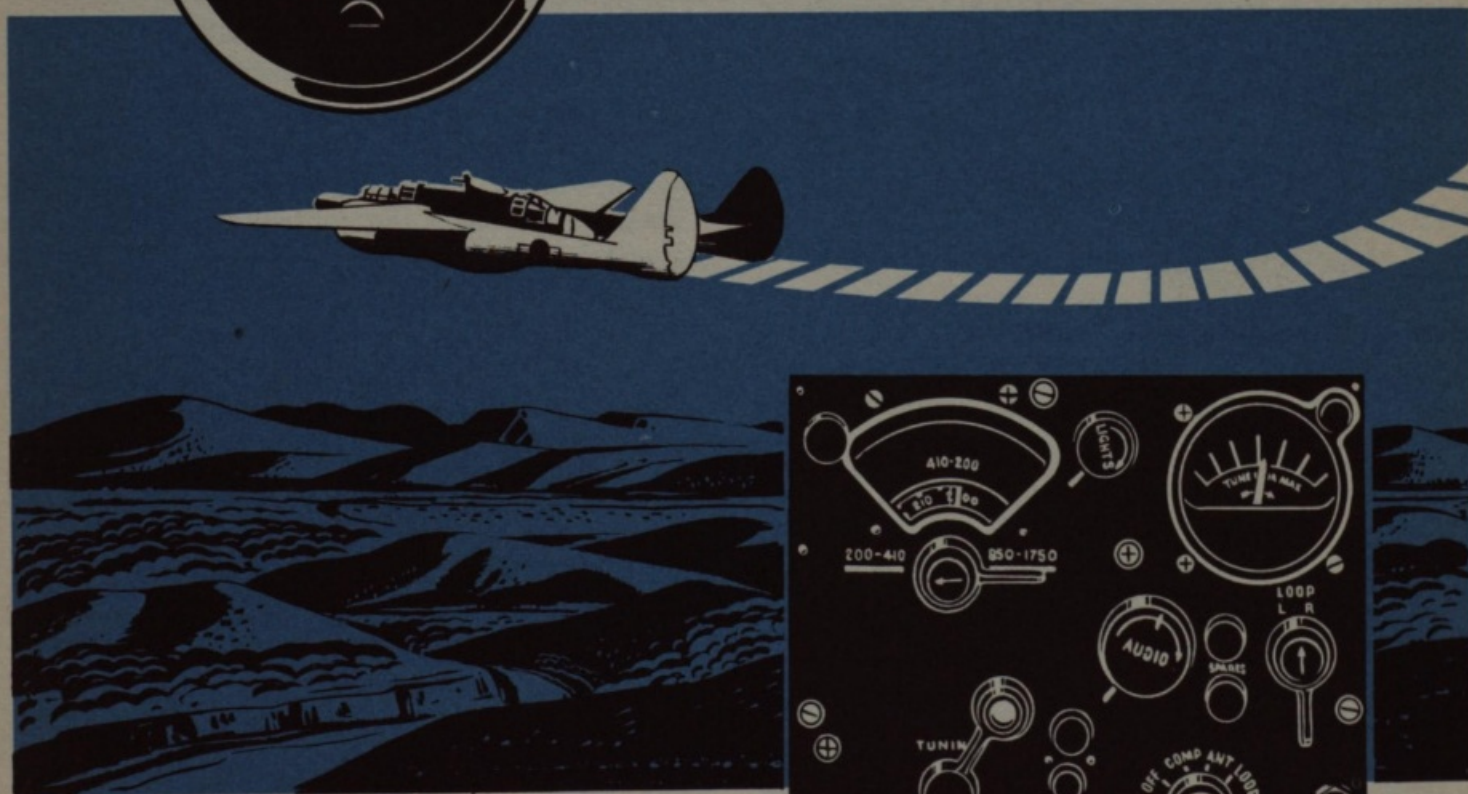

ADJUST SENSITIVITY OF COMPASS WITH KNOBS

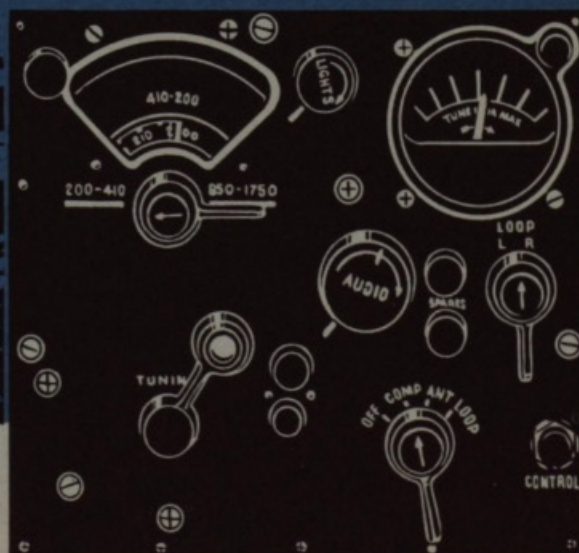

### Radio Altimeter

The radio altimeter is a device which tells you exactly how high you are above the ground that's directly underneath you. It doesn't function by means of a signal in the earphones. There is a dial on the instrument panel. This dial has two scales: 0 to 400 feet, and 0 to 4000 feet. By turning the knob at the upper righthand side of the altimeter's dial, you cause the reading of the dial to change from the 400-foot scale to the 4000-foot scale. The knob at the lower left of the dial turns the equipment on and off.

You use the radio altimeter mainly for low-level intruder flying and blind approach beacon landings. The lower scale of the instrument is used to give exact readings at extremely low altitudes, where a variation of even a few feet may be the margin between safety and disaster. You use the 0 to 400-foot scale, for instance, in making a blind approach beacon landing.

An altitude limit switch is part of the radio altimeter. This switch may be set at specific points within a range from 50 feet to 300 feet. So long as the plane does not vary from the altitude at which the switch is set, an amber light glows. If the plane dips below this altitude, a red light glows. If the plane exceeds the altitude at which the switch is set, a green light comes on. All three lights are located in a vertical row near the altitude limit switch.

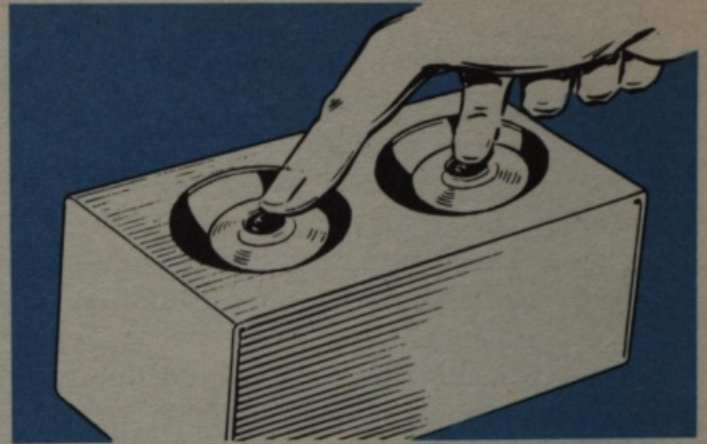
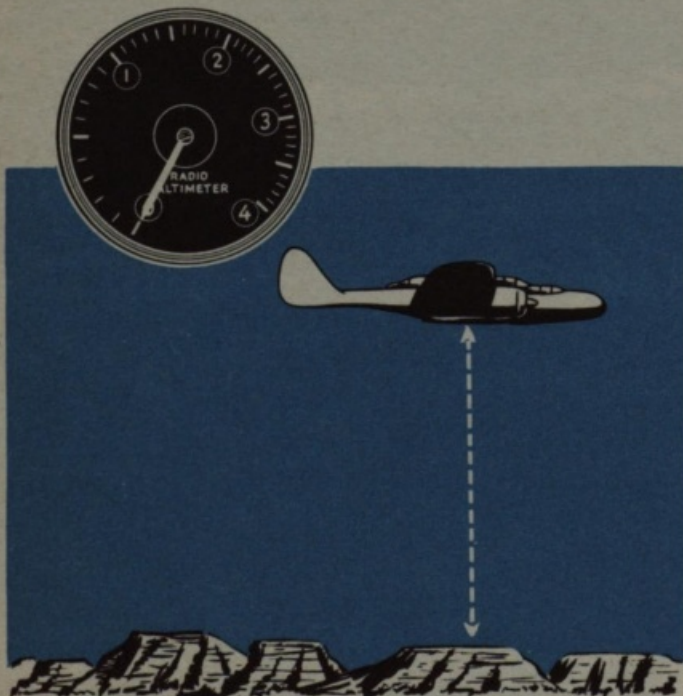

### SCR-695

Your radar observer normally operates the SCR-695, which identifies your airplane in flight, but there is also a set of controls, together with a destructor switch, on the right side of the pilot's compartment. The destructor will wreck this IFF equipment, for reasons of secrecy, if it ever becomes necessary to do so during a tactical mission. If you use it, **press both buttons of the destructor switch simultaneously.**

In case you, instead of the radar observer, are operating the SCR-695, start it by turning the ON-OFF switch to ON. The communications officer will have told you how and when to use the G band switches and the emergency switch.

### Trouble Shooting

If the VHF channel you want to use seems dead, first look at the control box. If no lights show there, the channel is really dead. In this case, reset the circuit breaker.

Generally, however, the silent channel merely seems to be **not working**, and you may be able to bring it back to life easily. Maybe your headphones or the mike aren't plugged in. (Don't laugh! That happens frequently.) Or perhaps the volume is too low.

The batteries may be weak and the voltage low **while taxiing**. To raise the voltage, increase the engine rpm until the generators start charging. Be sure your generators **are on**.

The crystal of the apparently dead channel may not be oscillating. Turn to any other channel and then back to the one you want to use. You frequently find, when you've done this, that the desired channel is now operating.

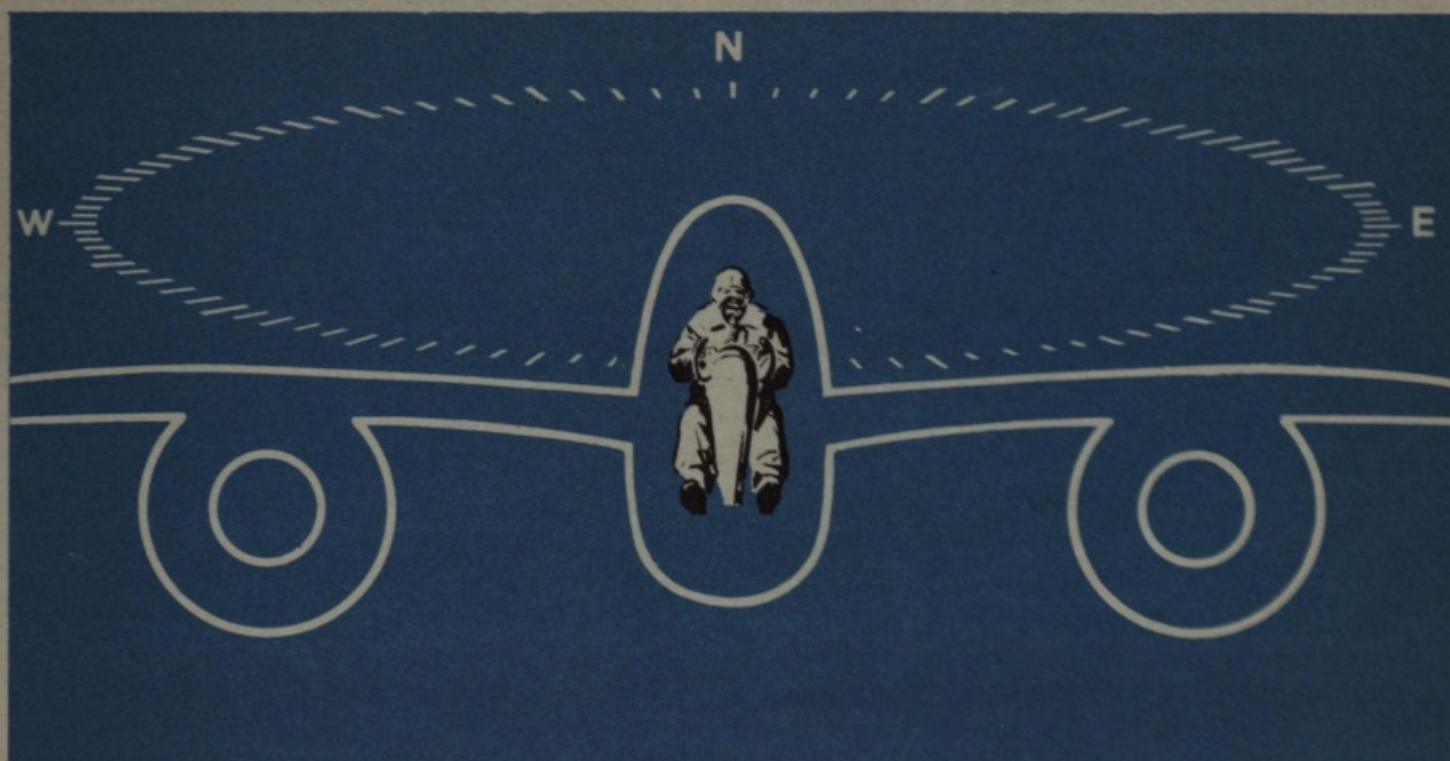

## DAY AND NIGHT NAVIGATION

Whether or not your gunner also serves you as navigator, there will be times when you have to navigate the plane yourself. Make up your mind now to practice navigation whenever you have a chance. Air navigation should become second nature to you. Practice it until it is as familiar and easy to you as flying near your home field.

Make **exact** computations. Remember that there is really no point in making them at all if you don't make them exact.

Practice navigation in straight and level flying with this in mind: you must hold the course accurately and keep the airplane as level as possible while the navigator, if you have one, takes celestial observations or radio bearings or tries to read drift accurately.

If possible, try handling the sextant. See for yourself how hard it is to center the bubble when the ship is not level. Try to read drift while the airplane is swinging from side to side. This will help you understand the navigator's problem.

The E-6B computer solves all your navigational problems that arise from the effects of

the wind. If you are not sure how to use it, read the T.O.'s on Instrument Flying. They tell you exactly how to do it.

### Navigation for the Pilot

Suppose you are about to practice navigating on a typical cross country flight:

1. Make sure you have Radio Facility Charts, Instrument Approach Procedures, Cross Country Envelope and required emergency kits.
2. Get proper sectional and regional charts of the intended flight area.
3. Draw in the true course from departure to destination on your sectional charts. Remember, it's just a **straight line** between those two points.
4. Study the intended course for check points, auxiliary airports, and the height of the terrain. This helps you choose the proper altitude at which to fly. Draw a circle around the prominent check points you may use. This makes map reading much easier in the air.
5. Visit the weather office to find the winds aloft. Get the winds at several altitudes, in case you have to change altitude in flight. Choose



## RESTRICTED

the altitude that will give you the best tailwind, if other conditions don't prevent its use.

6. Measure your true course. Apply drift correction from winds aloft, variation and deviation to obtain the correct compass heading.

**True course** is what you measured on that straight line to destination.

Apply **drift correction** from the wind at flight altitude and you get **true heading**.

Apply **variation**, which is a bunch of gremlins pulling your compass needle out of whack. In some sections of the country they are stronger than in others. Easterly variation is a **minus** correction. Westerly variation is a **plus** correction.

Remember: "East is Least; West is Best!"

This gives you **magnetic heading**.

Apply **deviation**, which is the error in the compass itself. A little card next to the compass gives you the deviation. If there is no card, forget about deviation.

Now you have your **compass heading**—that's what you want to be reading on your compass all the time.

7. Knowing what the wind will be, set the wind on your E-6B computer and find the **true airspeed** that will give you the groundspeed you want to maintain. To find the **indicated airspeed** you have to hold to make this airspeed good, use the following rule of thumb:

To change indicated airspeed to true airspeed at—

5000 feet, increase IAS by 5%  
7500 feet, increase IAS by 10%  
10,000 feet, increase IAS by 15%  
15,000 feet, increase IAS by 25%  
20,000 feet, increase IAS by 35%  
25,000 feet, increase IAS by 50%  
30,000 feet, increase IAS by 65%  
35,000 feet, increase IAS by 80%

To change true airspeed to indicated airspeed: Divide TAS by 1.05, 1.10, and so forth, depending upon the altitude at which you will be flying.

8. Mark off your intended course in 20-mile intervals. This helps you make groundspeed calculations during flight.

9. Check the altimeter setting on the ground, and, by radio, at flight altitude. Be sure it is set

properly. You don't want to be running into any mountains or towers!

10. Watch for abnormal changes in temperature. Such changes alter your TAS and drift. The temperature is worth watching.

11. Note the time of takeoff and time over check points, to obtain correct groundspeed. Keep your eyes on the terrain at all times while not checking instruments or sky-gazing. Get off to a good start by figuring out how long it should take you to climb to your cruising altitude and how far you will have traveled by the time you reach that height.

12. Find groundspeed by setting distance over time on the computer.

13. Find your estimated time of arrival by computing the time necessary to cover the remaining distance to your destination.

### Fuel Facts

Learn how to check fuel consumption. Remember these points:

On the computer, read "gallons" where it says "miles." "Gallons" replaces "miles" in this calculation.

1. Gallons per hour **always** falls on the outside scale opposite the black hour pointer.

2. Gallons consumed is **always** found on the outside scale.

3. Time taken to consume fuel is **always** found on the minutes or hours scale. The two scales on the movable disk are hours and minutes.

### How to Get Back on Course

If you have flown for 60 miles, each mile you are off course is equal to 1° off course. For every mile you are off course, correct 1°. You are then paralleling your intended course. By correcting 2° for every mile off course, you will be back on your intended course in 60 miles.

You can use corrections proportionately. If you are 4 miles off course after flying 20 miles, that is the same as being 12 miles off course after flying 60 miles. If you fly 120 miles and find you are 24 miles off course, that is also the same as being 12 miles off course in 60 miles.

Remember: Hold a constant compass head-

ing. If you wander all over the sky, these corrections aren't worth a plugged nickel!

If you don't know your position, **hold your compass heading!** By holding a constant heading you always know how long you've been flying that heading, and can estimate pretty accurately what your groundspeed is. With these factors known, you need only to estimate the amount of wind drift to locate yourself and correct your course. You won't be very far from where you should be.

If you start changing heading you lose all conception of time, speed and distance. You'll be unable to do any figuring. Then you will be lost for fair.

So, don't change heading unless you know **where** the change of heading will take you.

### Lambert Conformal Map

You must know how to use a Lambert Conformal map. That is the map you use most of the time.

Measure courses on mid-meridians (that means the meridian that's half way between departure and destination).

This gives you the average course, because the meridians converge at the top of the map,

and a straight line makes a different angle with each meridian.

The scale is constant. One minute of latitude equals one nautical mile. Statute mile scale is at the bottom of the map. Your Weems plotter also has the statute mile scale along its length: the outside scale for use on regionals, and the inside scale for use on sectionals.

### Mercator Projection

Now, learn these facts about the Mercator Projection:

Meridians on it are parallel. So, measure your course on **any** meridian.

But, since the latitude scale expands as you travel away from the equator, use the latitude scale exactly opposite the section of the chart on which you are measuring. This is called measuring on the mid-latitude scale.

In tactical operations, Mercator charts are sometimes the only charts available. That is why it is important for you to know how to use them. You can use a small Mercator to fly around the entire earth at the latitude which the chart covers. The longitude may be changed to make the chart conform to any desired section of the earth at that latitude.



## NIGHT NAVIGATION

Before you fly on a night navigation mission in the P-61, be sure you know these facts about pilotage at night:

Automobile headlights point out roads to you.

Rivers and bodies of water are easy to see in the early evening and on nights when there is a moon. The water reflects the sky and you

can easily see that reflection from the air. In preparing for a night mission always mark plainly on the map any bodies of water that can be seen from the air.

In checking towns from the air at night, practice judging their size. It isn't an easy thing to do, but when possible check a town of one size



against a town larger or smaller to obtain relative size.

Mountains are often silhouetted against the evening sky and sometimes you can see them at night. The relationship of towns to prominent mountains gives you a better check point than either one by itself.

Airways light lines are easily distinguished. If you're in doubt about your position, and if you have enough gas, try to fly across a light line and orient yourself.

A light line is a series of beacons that flash six times a minute. They are placed from 10 to 15 miles apart, and most of them continually flash in red a code letter along the direction of the airway. The beacons flashing the code in red have no night landing facilities. The beacons flashing the code in green have night landing facilities. There are also beacons that flash the code in amber, which sometimes looks white.

These beacons indicate there are unlighted emergency landing fields in the immediate vicinity.

The beacons are numbered from 1 to 10 in the direction of the airway and always originate at a prominent town. Remember the code letters that correspond with the numbers by memorizing the following sentence:

On many airways there are more than 10 beacons. The code sentence starts over again with Beacon Number 11, Beacon Number 21, and so forth. Therefore, be sure to identify a beacon in relation to nearby towns or terrain features. Make certain, for instance, you are identifying the Number 5 beacon and not the Number 15 beacon.

You can readily tell where you are on the airway or where you are crossing it, for the code is marked prominently on your sectional charts. With this information you can orient

NUMBER OF BEACON	CODE	CODE LETTER
1	••—	When
2	•••—	Undertaking
3	••••—	Very
4	•••••	Hard
5	•—•	Routes
6	—•—	Keep
7	—••	Direction
8	—•••	By
9	—•—•	Good
10	—•—••	Methods

yourself and get a new start for your destination. If possible, follow the light line until you reach a point where the course to your destination is practically perpendicular to the light line. This will give you the shortest possible distance to travel away from the light line and lessen the possibility of getting lost.

If a highway runs from the vicinity of the light line towards your destination, however, there will be towns along the highway. The lights of automobiles and of towns will serve as adequate check points so that you can follow the road to your destination.

Remember, an airway is like a highway. Keep to the right. But be sure that you do not fly a "scalloped" course in following a light line. This is likely to happen to an inexperienced flyer when he can see only one beacon at a time ahead of him. In his attempt to keep to the right of this beacon, he frequently veers from his course. When he has flown far enough beyond to spot the next beacon, he finds he must swing back to the right again to pass it on the proper side. This not only results in a wavy course but may cause the pilot to become lost.

The best way to avoid flying a scalloped course and to avoid getting lost is to fly cross country at night on your automatic pilot. This is like having a co-pilot to do the flying while you navigate.

Under no circumstances should you try to drag a strange field at night for an emergency landing. If you are hopelessly lost and about out of gas, climb the airplane to at least 3000 feet, if possible, trim to level flight, set it on automatic pilot, head it towards sea or mountains, cut the switches just as you leave, and bail out.

### Blackout Flying

When you are flying at night strictly under ground control it is quite possible that you will not see the ground or any lights on the ground from the moment you leave the field until you return, several hours later, with a couple of scalps to your credit. You will fly entirely on instruments, taking vectors and other directions from your control station or flying on instruments under the direction of your radar observer. A lot of the time you probably won't

have the least idea where you are. You return home through the aid of your ground control or the radar equipment in your plane. You may also land with the aid of your blind approach beacon system.

On intruder missions, you'll probably be navigating strictly on your own. Your navigation then is largely dead reckoning and night pilotage with the aid of lakes, rivers, shorelines and mountains. The radar and radio equipment in your P-61 also help you navigate under most conditions. At times you may have the aid of a beacon or the help of friendly searchlights, usually on the return flight only.

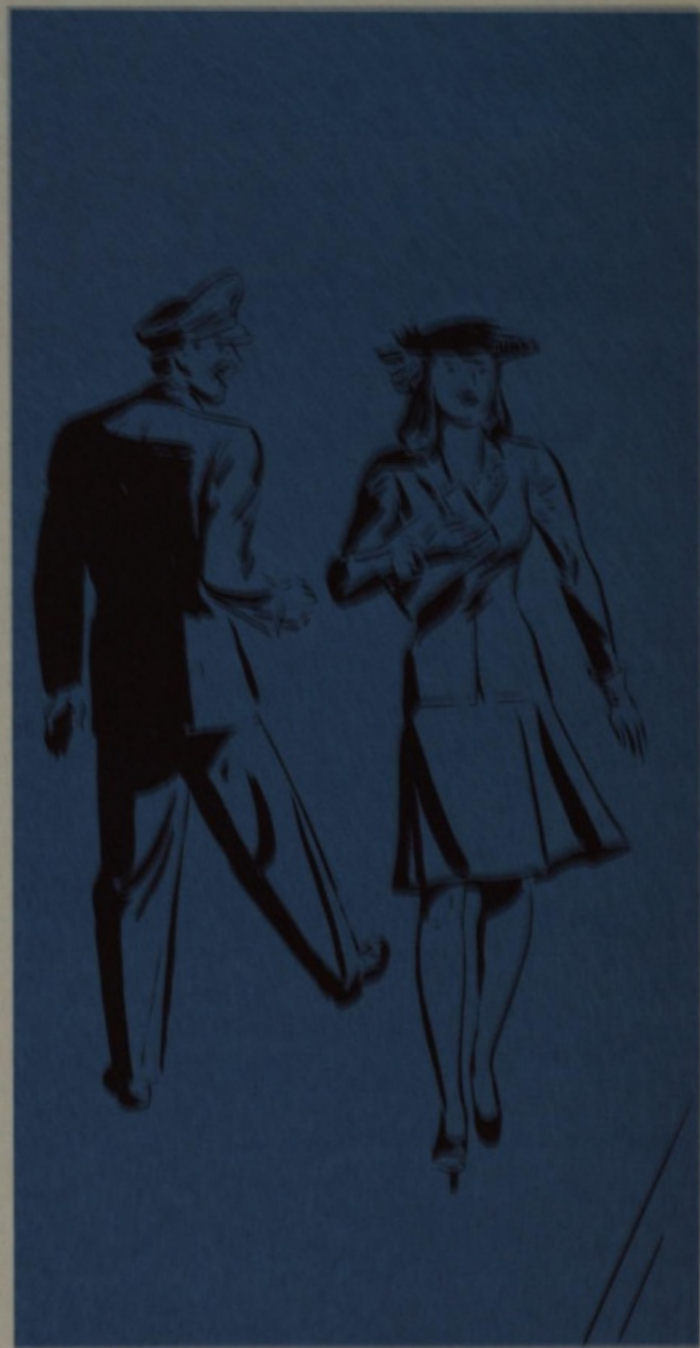

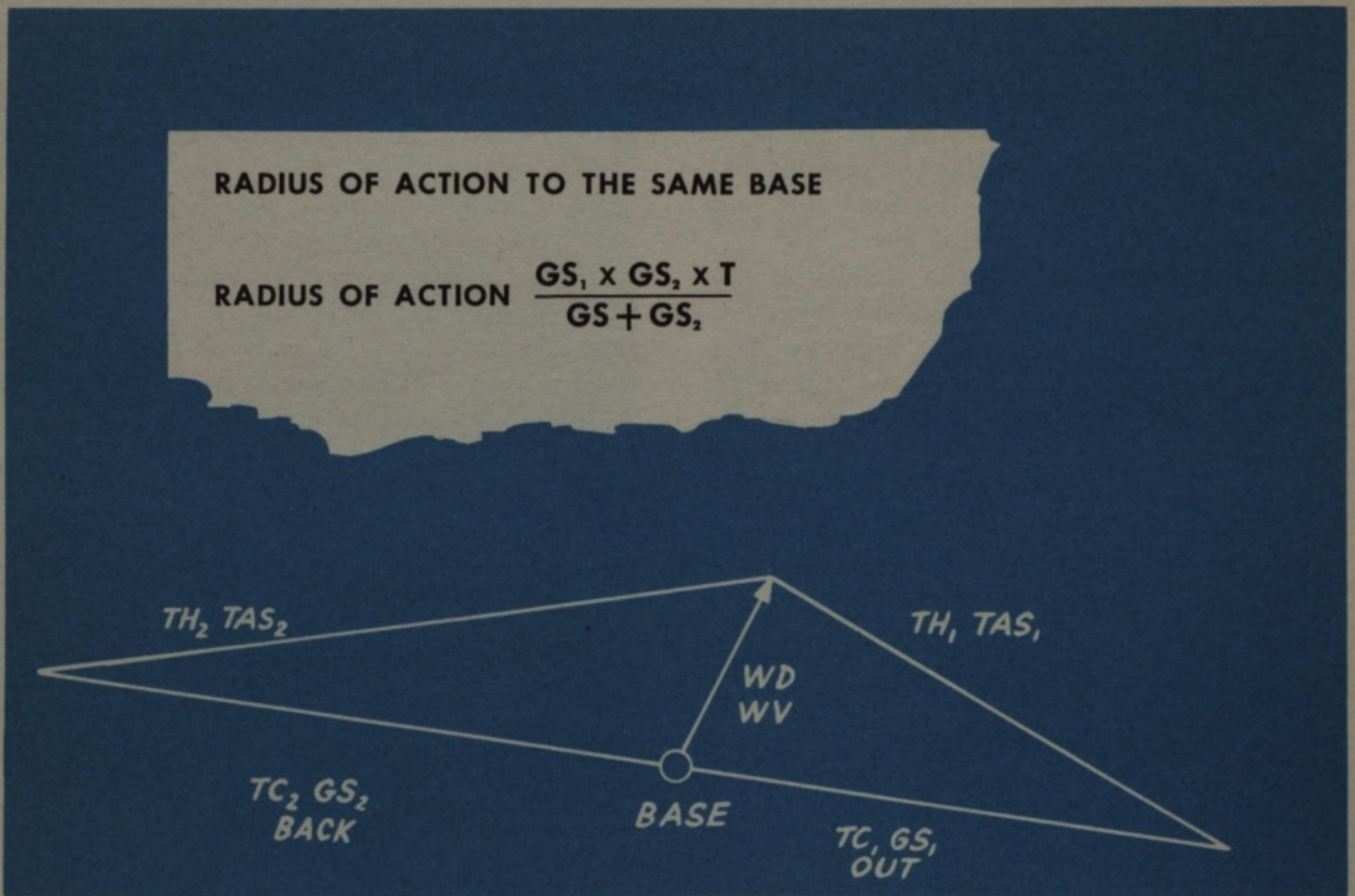

## RADIUS OF ACTION

Before every instrument flight, or a flight where the weather is doubtful, work a radius of action problem. This tells you at what point you will have to turn back in order to reach the airfield from which you departed, or an alternate airport. Accordingly, you actually have two problems.

**Note:** When you work on a Mercator chart, you make all measurements from a mid-latitude scale, and thus they are in nautical miles. The symbol for nautical miles per hour is K.

After you have solved the problem, you can easily convert the nautical to statute miles.

Since you know the groundspeed out, and how far out you can go on this heading before you must turn, it is a simple matter to find at what time you must turn around.

$GS_1$  = Groundspeed out

$GS_2$  = Groundspeed back

T = Available fuel hours.

Twenty-five per cent of the total fuel is usually held in reserve for unforeseen emergencies. T then is equal to total fuel hours minus 25%.

This is how you construct the diagram:

First, set the wind arrow off from your point of departure. The wind used is the wind aloft at the altitude at which you intend to fly.

Next, from the end of the wind arrow, with the help of a pair of dividers set at your probable true airspeed for one hour, swing this true airspeed off until it crosses your course. Then swing it off until it crosses the reciprocal of your course. Draw lines connecting the end of the wind arrow and these two points on your course and your reciprocal.

By measuring the length of these two distances from departure, you find the groundspeed out and the groundspeed back.

# RADIUS OF ACTION TO AN ALTERNATE BASE

GIVEN:

35°00'N

Leave Base "A" 122°00'W to patrol a course of 330° and return to Base "B."

36°29'N

120°57'W

T = 3 hours.

TAS = 135K

Wind from 10° at 30K

FIND:

Hourly Increment = 34½ N.M.

True heading out (TH<sub>1</sub>) = 338°

True course return (TC<sub>2</sub>) = 118°

True heading return (TH<sub>2</sub>) = 106°

Groundspeed out (GS<sub>1</sub>) = 111K

Groundspeed return (GS<sub>2</sub>) = 142K

Rate of departure (S<sub>1</sub>) = 98

Rate of return (S<sub>2</sub>) = 144

Time on TC<sub>1</sub> (t) = 1:47

Distance on TC<sub>1</sub> (RA) = 198 naut. miles

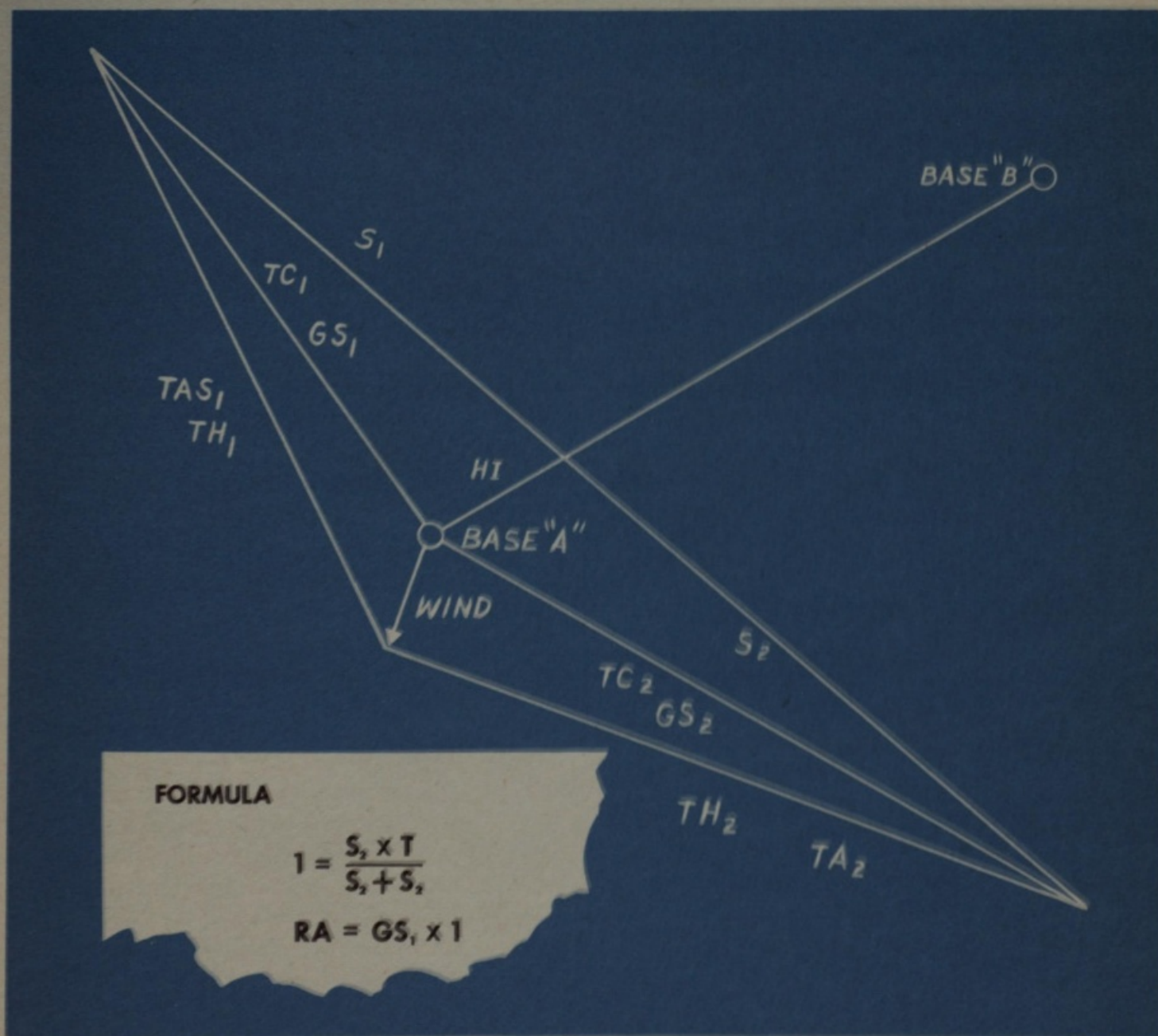

## RESTRICTED

### Procedure

1. Plot in Base "A" and Base "B" on Mercator Chart.
2. From Base "A" plot patrol course of  $330^\circ$ .
3. Through Base "A" plot wind direction from  $10^\circ$ .
4. Using mid-latitude scale on Mercator determine length of wind arrow. (30K)
5. Using mid-latitude scale swing TAS (135K) from end of wind arrow to intersect patrol course.
6. Draw line of bearing between Base "A" and Base "B."
7. Divide bearing line into an equal number of parts to correspond to the number of hours you intend to run. ( $T = 3$  hours). Divide distance between "A" and "B" by  $T$ , and mark the results off from "A" towards "B."
8. From the intersection of the  $TH_1$  and  $TC_1$  lines drop  $S_1, S_2$  line through the first hour seg-

ment of bearing line, point "M."

9. Using mid-latitude scale swing TAS (135K) from the end of the wind arrow onto  $S_2$  line and connect these points.
  10. Complete second vector triangle by plotting  $TC_2$  from Base "A" to the intersection of  $TH_2$  and  $S_2$ .
  11. Solve formulas using mid-latitude scale for values of  $GS_1, GS_2, S_1$  and  $S_2$ . (You must convert that "t" of your formula into hours and minutes.)
- The advantage of working this problem is that it tells you where the deadline is. At any time before reaching, or upon reaching, the Radius of Action of your airplane with the winds and fuel supply as they are, you can turn back to your alternate airport. After that time, you must proceed to some other base. You won't have enough fuel to get back to the alternate base on which you had planned to land.

## INTERCEPTION

The ability to work and fly an interception problem is important, because of the necessity of intercepting enemy surface craft, and being able to rendezvous at the proper time for formation attack. If you don't reach a formation on

time, they'll go off and leave you. If you get there too soon, you may run out of gas waiting for the rest of the formation, or at least warn the enemy of impending developments.

If you want to drop your bombs on enemy

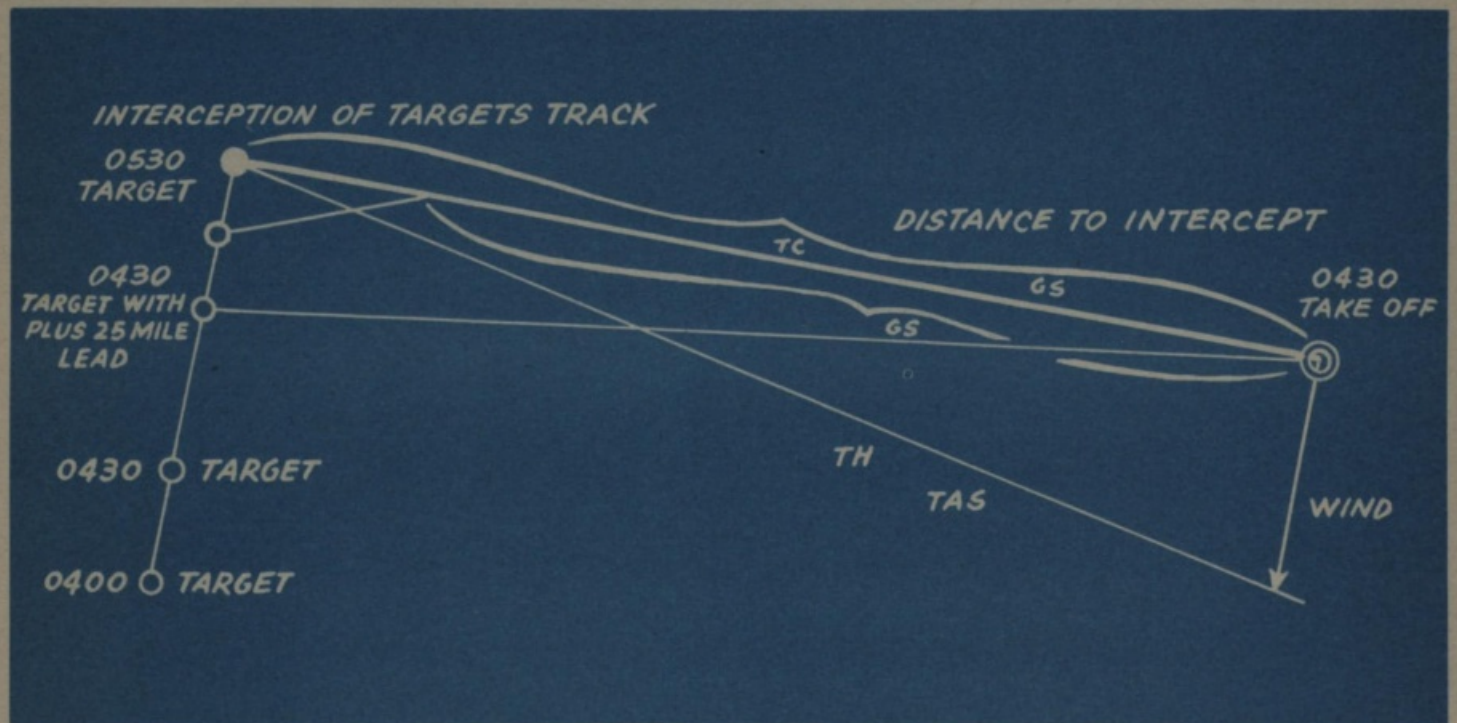







## EMERGENCY OPERATIONS

There are three ways for you to leave the P-61 in a hurry. Your choice of exits depends on the emergency.

When you ditch the plane, climb out through the top hatch in your own compartment of the crew nacelle. You may also take this way out in case of a bad engine fire while the plane is on the ground. **It is not a safe emergency exit for bailout, however.** You're almost sure to get caught on the guns, hit the horizontal stabilizer, or fall into the propellers.

As soon as you have decided that the crew and you must bail out, warn the gunner and RO by interphone, if you can. To make sure they understand your decision, ring the warning bell three times and then leave it ringing.

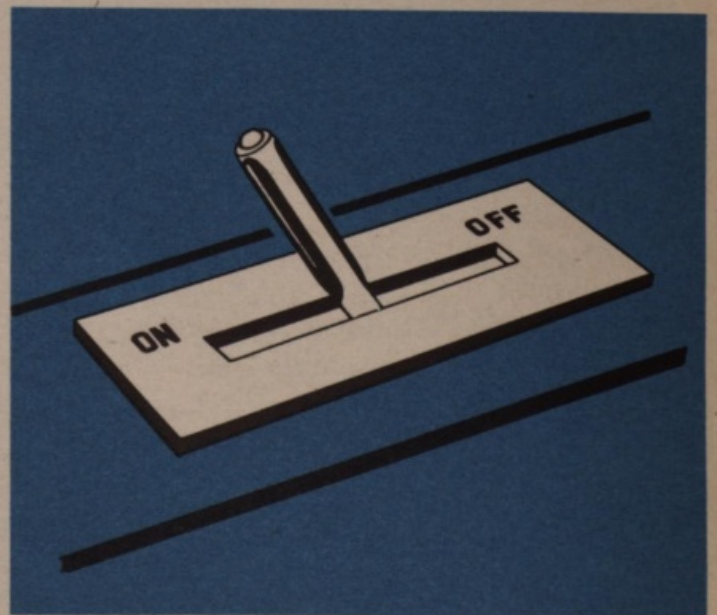

### Quick Bailout

In a quick bailout, first slow the airplane as much as possible. There are several ways of doing this, but the most practical is to pull it up in a medium climb. By doing this, you gain altitude and lose speed at the same time.

If you have to bail out in the shortest possible time, you'll probably use the gunner's escape hatch. When you leave the plane this way, collapse the back of your seat with a shove of the push rod, turn around on your knees, and crawl back to the gunner's seat. If his armor plate is locked in position, unbolt the lock at the bottom and brush the armor plate out of your way.



If you're able to hold on in the hurricane that's blowing out there, you and he then climb onto the inner wing and slide off over the leading edge, face down. Otherwise, you both are blown off over the trailing edge of the inner wing and hope you don't strike the horizontal stabilizer on the way down. In the meantime, your RO goes out through the bottom hatch of his compartment. He gives the red emergency release handle a strong tug at the same time he pulls the normal release. This removes the hinge pins and, when it is given a sharp kick, the door drops free. Then, facing the rear of the plane, the RO jumps out, feet first. He jumps with his hands raised before his face and shoves himself clear of the rear edge of the opening as he drops. This prevents his head from hitting the crew nacelle as the lower part of his body is blown back in the slipstream.



RESTRICTED

**Controlled Bailout**

The safest way for you and the gunner to bail out of the plane, if you're able to control the conditions, is through the entrance hatch in the bottom of the forward cockpit.

First, put the airplane on automatic pilot, if you can, and fly at the slowest feasible speed (about 140 mph IAS). Then, lower the landing gear. It's now the gunner's job to scuttle the entrance hatch. He turns the latch and, at the same time, pulls the emergency release handle. The hatch drops away when he gives it a sharp kick. Then, the gunner leans forward and dives

out. The RO, meanwhile, leaves the plane, feet first, just as he does in a quick bailout.

When you're ready to leave the plane yourself, collapse the back of your seat and dive out, head first, through the hole in the floor. **If it is at all possible to do so, step over the floor opening, turn around, and face the nose of the plane before you dive.**

You should know how to make a good parachute jump. If you are at all uncertain about how to jump in the best and safest way, read the section of the Pilots' Information File on this subject. **Make sure your crew members read it, too.**

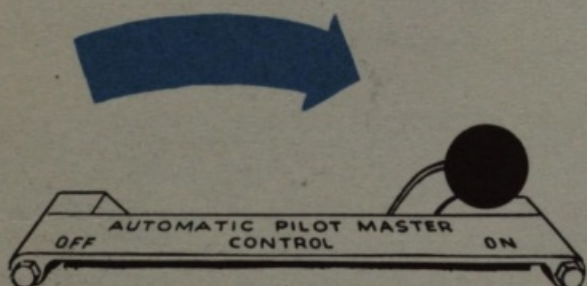

**1** TURN AUTOMATIC PILOT ON



**2** LOWER LANDING GEAR

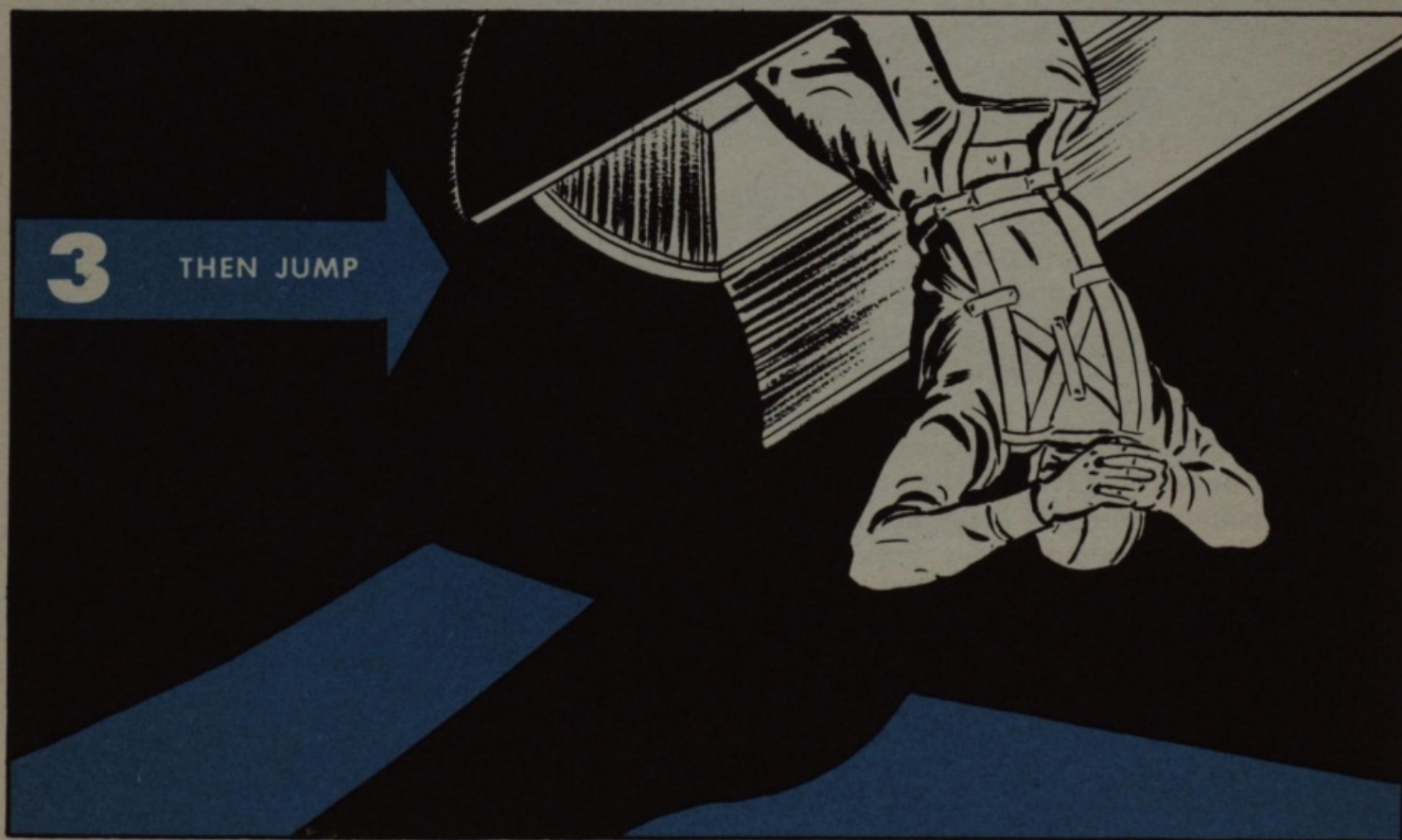

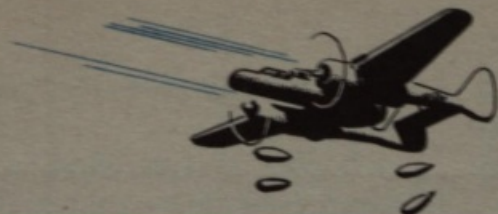

## DITCHING

Never ditch a P-61 at night, unless you are too low to bail out. If serious trouble develops while you're flying over water in daylight, and you decide to ditch the plane, don't wait until the last minute before letting the crew in on your decision. There are several things you all have to do before setting the plane down. Warn the crew by interphone; or ring the warning bell six times and then leave it on.

As soon as you have decided on ditching, send out an SOS, giving time and position. Do this in plenty of time before you hit the water. If it turns out that you don't have to ditch the plane after all, you can always cancel the distress call.

If the plane is carrying external wing tanks, drop them immediately. If it is carrying bombs, release them unarmed. Provided you have time, fire all the ammunition in the plane. This precaution has double value. It prevents an ammunition explosion on landing and at the same

time lightens the plane considerably.

Unfasten your parachute, and have the crew do the same, but be sure you all re-fasten shoulder harnesses and safety belts.

Have your RO and gunner check to make sure the bottom entrance doors of the forward and aft compartments of the crew nacelle are closed and fastened. Then, each one of you must open his overhead escape hatch. The gunner can get rid of his entirely. Yours and the RO's will almost certainly blow away. Then, there is no danger of jamming the hatches when you land. All three of you can make a quick getaway the instant the plane stops moving.

If you have to ditch at night, turn off all bright lights inside the plane as soon as it is feasible to do so. This helps you and the crew to accustom your eyes to the darkness before you have to leave the plane.

Ditch the airplane while there is still enough

## RESTRICTED

fuel left to make a power-on landing. Under power, you are sure of being able to control the plane and flatten it out properly for a satisfactory landing on the water.

### Approach and Landing

As the airplane nears the water, try to find out which way the wind is blowing on the surface and about how strong it is. Watch the lines of waves and note which direction they are moving. The wind is certain to be at right angles to them, unless you are close to shore or over a



swift current. To be doubly sure of the wind direction, look carefully at the surface of the water in the troughs of the waves. Remember, it always appears to be flowing **into the wind**.

Don't mistake swells for waves. Swells have no breaking crests. Furthermore, they don't necessarily move with the wind, the way waves do. You want to land along the upslope of a swell, if surface conditions permit.

Land at the slowest possible IAS. **Don't lower**

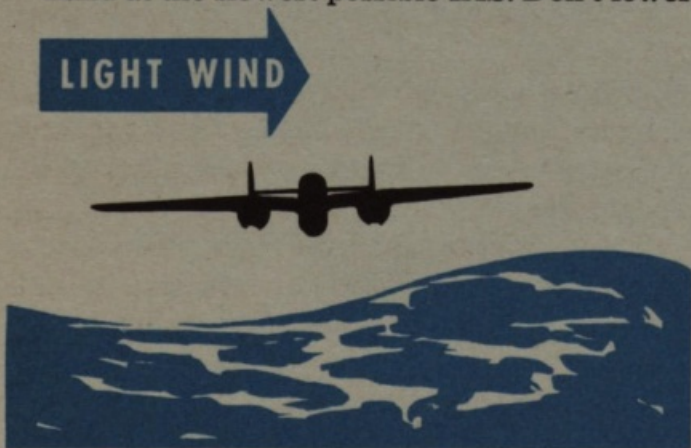

**your landing gear.** Put your wing flaps down about  $\frac{1}{3}$ .

If only a light wind is blowing across the swell, land crosswind and ditch the plane on an upslope, parallel to the movement of the swell. If a heavy wind is blowing across the swell, face into the wind as much as possible and ditch the plane on an approaching upslope near the top. If you are landing in waves or in a steep swell, set the plane down on the top of a wave or swell, unless there is an exceptionally strong crosswind.



Have it understood with your crew that just before the plane strikes the water each man is to shield his face with his left forearm. This protects the head from pieces of debris and helps absorb shock in case it is thrown forward against part of the structure.

Land the plane in the water with its tail down. You feel a slight jolt as the rear of the airplane strikes, then a severe jolt and rapid stop as the rest of it hits the surface. The faster you are traveling when you strike the water, the more rugged the impact is and the greater the danger of having the plane collapse. Also, in an overly fast landing, the plane usually bounces. This makes collapse all the more likely.

You and your crew must release your safety belts and climb out through the top escape hatches as soon as the plane stops. Inflate your Mae Wests. Pull your individual dinghies loose from the parachutes. Inflate the dinghies and wriggle into them. Salvage the parachutes if you possibly can, for sails, cover, and extra lines. They come in mighty handy.

### If the Hydraulic System Fails

Your hydraulic system may fail because of a leak in a line or unit, or failure of the engine-driven pumps. The pressure gage usually warns you of such failure by dropping well below the normal reading of 850-1000 psi.

If there's a leak in the main system, the hydraulic fluid in the accumulator and about one-third of the fluid in the main reservoir is still available for emergency operation.

For a short time, if you pump like mad, you can operate all the hydraulic equipment except the automatic pilot by means of your hand pump. That is, unless the fluid is leaking so fast the hand pump can't supply pressure. The best idea, in case the hydraulic system fails, is to save the hand pump for operating your flaps and brakes during landing. Both of them work from the accumulator.

### Emergency Air Brake

There is a good chance that the hydraulic pressure you build up with the hand pump will be all gone after you've lowered the wing flaps. In that case, use your emergency air brake system in landing. The release lever, marked **EMERGENCY AIR BRAKE**, is along the cockpit rail at your left, just above the electrical panel. When you pull this lever ON, air pressure flows into the brake lines from a storage bottle and forces the brakes on. There is enough air pressure in the storage bottle to enable you to apply and release the brakes about six times.

If you have to use the emergency air brake system, make sure the ground crew bleeds the lines afterwards and refills the storage bottle to 425 psi.

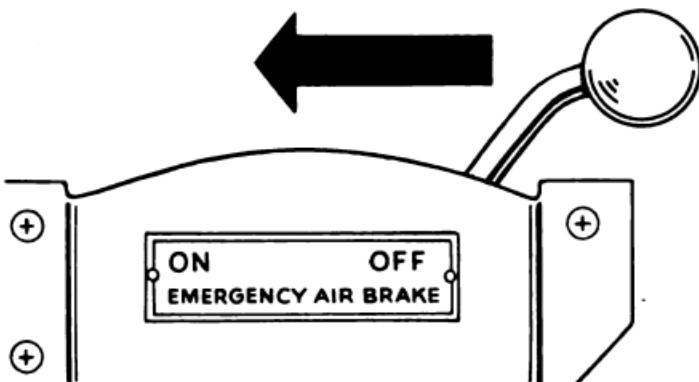

### No-Flaps Landing

If your flaps won't come down, either because they're stuck or because there isn't any hydraulic pressure, follow the normal traffic pattern, approach the field at 130-135 mph IAS (with normal landing weight of 27,000 lbs.), and put the main wheels on the ground at about 110 mph IAS. The plane's nose will be higher than usual during the approach and landing. Try to avoid hitting the ground with the tail either during or after landing.

In making a landing without flaps, use the emergency air brake rather than wasting time trying to build up brake pressure with the hydraulic hand pump. There may not be any hydraulic fluid left.

### Emergency Operation of Landing Gear

In case the main hydraulic system of the plane fails, operate your landing gear with the aid of the hand pump, if you can. Put the landing gear lever DOWN, turn the hand pump selector valve to SYSTEM, and pump as hard as you can until the landing gear wheels are locked DOWN.

If you can't build up enough hydraulic pressure for this procedure to work, try another method. Reduce the airplane's speed to 130 mph IAS or less. Then, with the landing gear lever DOWN, pull the landing gear emergency release handle. Hold this handle up until the nose gear is locked in the down position before you release it.

### Belly Landing

In the event that you have to land the P-61 with its gear up, follow this procedure:

1. If you have time, and other conditions permit, fire all the 20 mm. cannon ammunition.
2. Drain the airplane's oxygen supply completely. (You should have told your crew in advance that whenever you have to make a belly landing each man is to turn the red emergency knob of his oxygen regulator ON.) Get rid of the oxygen and you have removed a principal source of fire in gear-up landings.
3. Lower wing flaps all the way.

## RESTRICTED

4. Make your approach just above stalling speed.

5. Pull the mixture controls back to IDLE CUT-OFF. Turn the master ignition switch and master battery switch OFF.

6. Land at the slowest practical speed.

7. Take precautions against fire immediately after landing.



### Propeller Feathering (Practice)

As soon as you have been checked out properly in a P-61, thoroughly understand the correct way to stop and start the engines in flight, and are familiar with the way the plane flies with one engine dead, practice feathering the propellers. Do this frequently until you are sure that if an engine fails in flight you'll feather its propeller quickly and smoothly.

But here's an important point to remember: To protect the engines from possible damage, you practice feathering in a slightly different way than you do it in an emergency. It's a slight but vital difference. In practice, you close the throttle of the engine before you touch the feathering switch. In an emergency, you set the feathering switch and then close the throttle.

Because this distinction is important, first learn the proper way to practice feathering, as it is given just below. But study, too, the box on Emergency Feathering which appears on the opposite page. Memorize so well the procedure given there that if an engine fails in

flight, your brain instantly will remind you, "Feathering switch first!"



In practice this is the way to feather a propeller:

1. Close throttle.
2. Set feathering switch to FEATHER.
3. Move mixture control to IDLE CUT-OFF.
4. Shut off supply of fuel to the dead engine.
5. Turn ignition switch OFF, after the propeller stops rotating.

## EMERGENCY FEATHERING

In an emergency, this is the way to feather a propeller:

1. Set feathering switch to FEATHER.
2. Close throttle.
3. Move mixture control to IDLE CUT-OFF.
4. Shut off supply of fuel to the dead engine.
5. Turn ignition switch OFF, after the propeller stops rotating.

If for any reason the feathering circuit fails to work, you can still place the propeller blade at the feather angle. Return the feathering switch to NORMAL and hold the propeller selector switch in the DECREASE RPM position until the blade is feathered.

### Unfeathering the Propeller

To return a propeller blade to the position it was in before you feathered it:

1. Turn ignition switch ON while throttle remains closed.
2. Put propeller control lever in the DECREASE RPM position.
3. Turn fuel supply ON.
4. Move mixture control to AUTO RICH.
5. Set the feathering switch at NORMAL. Hold selector switch in the INCREASE RPM position until the engine speed reaches 800 rpm, then release it.
6. If the engine has cooled while the propeller was feathered, get the cylinder-head temperatures up to 100°C at about 800 rpm before you increase engine speed.

7. As soon as proper engine operating temperatures are reached, put selector switch in AUTOMATIC. Adjust mixture, throttle, and propeller control levers to the desired power and engine rpm.

### Engine Failure During Flight

With one engine dead and its propeller windmilling, with military power on the other engine, and with rudder trim neutral, you can control a P-61 down to a normal stalling speed (gear and flaps up) of 102 mph IAS. With gear and flaps lowered, you can control the plane down to a normal stalling speed of 80 mph IAS. **But you've got to do the right things quickly.**

Under normal conditions, you won't have to cut the power of your good engine. Just change its mixture to AUTO RICH. However, on the dead engine:

1. Set feathering switch to FEATHER.
2. Close throttle.
3. Move mixture control to IDLE CUT-OFF.
4. Shut off supply of fuel.
5. Turn ignition switch OFF, after the propeller stops rotating.

6. Close cowl, oil cooler and intercooler flaps.

If your forward speed happens to drop below the minimum for adequate control, gain speed by losing altitude. Don't apply additional power.

**Avoid violent maneuvers when you're flying on one engine.** Don't make steep turns into the dead engine, unless you know exactly how.

### If Fuel System Falls in Flight

If a fuel pump fails while you are in flight, the booster pump should maintain enough fuel pressure to keep the engine running normally. If the engine fails, however, turn the fuel selector valve to another tank and restart it. In case both fuel and booster pumps for one engine fail, turn the crossfeed valve ON, switch the booster pump on your good engine to HIGH, and restart the dead engine.

In the event that the fuel system on one engine has failed because of a break in the line to the engine, first turn the mixture control for that engine to IDLE CUT-OFF. Turn OFF the booster pump on the side where the break has occurred. Turn the selector valve OFF. If the crossfeed valve is ON, turn that OFF, too. Feather the propeller on the dead engine. Turn the ignition switch for that engine OFF as soon as the propeller stops rotating. Fly the plane on one engine and **keep a sharp lookout for fire.**



### If Oil System Fails in Flight

If the oil system in one engine fails while you are flying, follow this procedure:

1. Turn mixture control for that engine to IDLE CUT-OFF.

2. Turn selector valve OFF until the other engine needs the gasoline.

3. Turn booster pump OFF.

4. Feather the propeller on the dead engine. Turn OFF the ignition switch as soon as the propeller stops rotating.

5. Fly on one engine.



### FIRES IN FLIGHT

If a fire breaks out in an engine nacelle, first turn OFF the fuel supply for that engine and open the throttle. Then, close the cowl flaps. This may smother the blaze. If that treatment doesn't work, dive the plane. You may be able to blow out the fire.

In the event there is fire in a wing, turn OFF all switches for landing and navigation lights. Try to put out the fire by sideslipping.



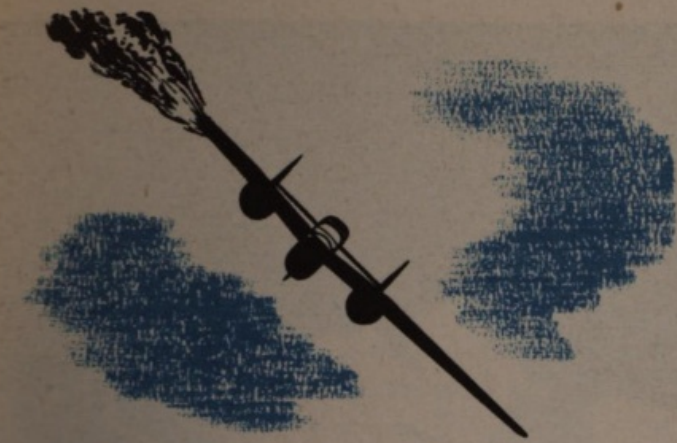

If a fire breaks out in the crew nacelle, first close all windows and ventilators. Then, if the fire is in the electrical system, turn the master switch OFF. If the blaze has started in a leaking fuel or hydraulic line, shut off the valves.

Use a fire extinguisher **immediately**. It is effective in fighting fires only as they start.

#### Oxygen System Failure

Separate systems supply you and your gunner and RO with oxygen. Have it thoroughly understood with them both that when one of them finds his oxygen supply has failed or is running low, he is to notify you immediately on the interphone, if he can. You will then descend at once, if tactical conditions permit, to an altitude at which lack of oxygen won't be fatal to him.

You have the responsibility, in addition, of checking frequently with both crew members at oxygen altitudes to make sure they are keeping an eye on their oxygen equipment. You can usually tell if the gunner is all right by looking over your shoulder at him. If your interphone query to the RO brings no response, descend immediately, if possible, to an altitude at which canned oxygen is not necessary.

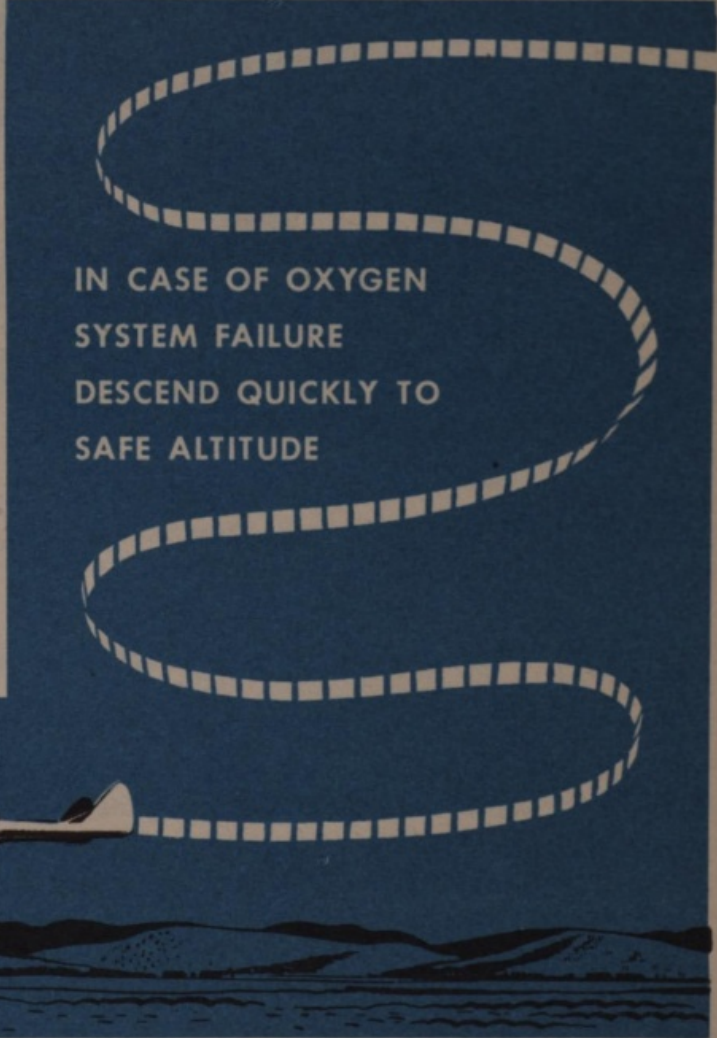

IN CASE OF OXYGEN  
SYSTEM FAILURE  
DESCEND QUICKLY TO  
SAFE ALTITUDE





## COLD WEATHER OPERATIONS

Don't read this chapter unless you are going into a cold weather theater of operations. It is confusing and valueless for pilots flying P-61's in mild climates. However, the information it contains is vital to your safety and the efficiency of your plane when you're flying in weather that's really cold.

Normally, a discussion of how to operate this

airplane in cold weather would begin with preflight instructions. However, before you can start the P-61's engines in Arctic temperatures, the oil must be diluted. And this is part of the afterflight procedure. It is done after landing, after the cylinder-head temperatures have dropped below  $205^{\circ}\text{C}$ , and before you have stopped the engines.

This is the proper procedure:

1. Operate both engines at 1200 rpm.
2. Maintain oil temperatures between 5°C and 50°C. Above 50°C, gasoline vaporizes from the oil.

Vary the dilution time with the temperatures expected while the airplane is not in use. Follow this schedule:

For temperatures from +4°C to -12°C (+40°F. to +10°F.), dilute oil 3 minutes.

For temperatures from -12°C to -29°C (+10°F. to -20°F.), dilute oil 7 minutes.

For temperatures from -29°C to -46°C (-20°F. to -50°F.), dilute oil 12 minutes.

There is much more work involved in preparing an airplane to fly in Arctic weather than there is normally. Only in exceptional cases are the planes kept in hangars. They stand out in all weather conditions. This makes the preflight check even tougher than the cold alone does. Accordingly, even you hot pilots must get out there and help thaw things out. The smart pilot will be there anyway, to double check and assist in the important preflight inspection routine.

### Preflight Check

Make the normal preflight check, with these variations and additions:

1. **Parking Brakes.** Have the maintenance crew move the airplane to see whether the tires are frozen to the ground. They shouldn't be, if you parked it on pine boughs or canvas, but in case they are, have them thawed out. If the plane moves but the wheels slide, the brakes are frozen. Have them thawed out.

2. **Tires.** Be sure your plane is equipped with special snow and ice tires. They provide far better traction for braking action. Air Service Command furnishes them when required.

3. **Covers.** Before the preflight check, remove crew nacelle and propeller covers; loosen and



roll back the engine covers. As soon as you have made the necessary check of ignition wiring, and so forth, button up the engine covers again in preparation for heating the engines with a hot air blast heater. If snow, sleet, or freezing rain is falling keep all other covers on until just before takeoff. If there is no precipitation, remove all except the engine covers during preflight inspection.

4. **Propellers.** Remove ice and snow by hand, or with a hot air blast heater.

5. **Instruments.** You may have to apply heat to make the normal preflight check of those instruments which operate independently of the engines.

6. **Controls.** If they work stiffly, the chances are that they are frosted or frozen in place. In either case, apply hot air.

7. **Starters.** Use hand crank to check each starter for freeness before you turn on the ignition switch.

8. **Booster Coils.** Mesh each starter with the ignition switch ON. Listen to be sure the booster coils buzz.

9. **Drains.** In addition to making the normal check of fuel drains, look at the oil tank sump drains. If no oil flows from the drain cock when you open it, obviously ice is present and must be thawed out.

Check the valves on the Y-drain fittings. **Never start the engines in cold weather until you've checked these valves and found that the oil is flowing freely.**

10. **Vent Lines.** Check them all and make sure they are free from ice.

11. **Accumulation of Snow.** Covers prevent snow from accumulating on the horizontal surfaces of the plane, but blowing snow sticks in every nook and cranny that will hold it. During preflight inspection, look for and remove every bit of this snow by hand or with compressed air.

12. **Frost Removal.** If all the plane's covers have been on since its last flight, as they should have been, you will not have any frost removal problem. However, if there is frost on any surface of the airplane, you must remove it with a blast of hot air before you take off. Frost is mighty treacherous. One time you can take off with a heavy coating of it on the plane and

## RESTRICTED

have no trouble. The next day, with the same amount of frost present, you won't be able to get off the runway. Play safe, always use the covers when the plane stands outdoors, and don't give frost a chance to form.

**13. Windshields and Windows.** If the plane has been properly covered, there shouldn't be any frost on the inside of the glass surfaces. However, if there is frost, the best way to remove it is to warm the cockpit with blast heaters and wipe off the frost as it melts. Once the windows are clear and dry, open them until you are ready to take off. Make sure you can open the clear view panels easily if you have to use them.

**14. Batteries.** They should be warm before you start the engines. Keep the batteries indoors between flights, if possible.

**15. Oil.** Oil that has been removed from the airplane must be heated to at least 70°C. before it is put back in the oil system. If the oil has not been drained, use the heaters in the oil tanks to heat it before starting.

**16. Engines.** Before you attempt to start or even to heat your engines on a cold day, first make certain there are adequate CO<sub>2</sub> fire extinguishers handy. Raw gasoline and fumes are always present in abundance and one-quart carbon tetrachloride fire extinguishers are relatively ineffective in fighting a gasoline fire.

If the outdoor temperature is below -18°C (0°F), don't try to start the engines without first heating them. If they still have enough heat left from the previous flight to indicate any cylinder-head temperature at all, this pre-heating should not be necessary.

Pre-heating engines can take as long as three hours, depending on outdoor temperatures and equipment available. The colder the weather, the sooner you start this process, if you want to fly on schedule.

Use hot air blast heaters, Type D-1 or F-1, if they are available. Be especially careful in using makeshift heaters. Open flames are particularly hazardous because gasoline is vaporizing from the oil and coming out of the engine breathers. But, whatever type of heat you use, take care to protect all rubber and fabric-covered hoses from temperatures above 121°C

(250°F). Use an asbestos baffle or metal sheet for this purpose.

**17. Starting.** As soon as the engines are warmed externally, your first step is to unbutton and loosen the engine covers. Then, when you have made sure the ignition switch is OFF, the mixture control is in IDLE CUT-OFF position, and the throttle is wide open, have a member of the ground crew hold the duct from the hot air heater in turn to each outboard carburetor air intake in the leading edge of the wing. At the same time, see that someone else holds a board cover tightly over the inboard carburetor air intake of the engine that is being heated. This prevents the hot air blasts from going in one intake and coming right out the other.

While the hot air is being directed into the outboard carburetor air intake of each engine in turn, have other crew members turn the engine over by hand through at least 6 revolutions. This heats and dries the spark plugs, the induction system, and the inside of the cylinders.

As soon as the preheating of both engines is complete, remove engine covers.

In cold weather starting:

**Use an external battery cart, by all means, if one is available.**

Underpriming causes more difficulties than overpriming.

The time required for adequate priming varies from 5 to more than 30 seconds, depending on the outdoor temperature.

After the primer has been held on for the usual length of time while energizing the starter, you may have to keep on priming the engine after the starter is meshed until the engine runs. It may even be necessary to run the engine on the primer until it is firing on all cylinders.

If backfiring occurs, the engine is underprimed. On the other hand, a sure indication of overpriming is gasoline dripping from the exhaust stacks. If you overprime the engine, keep the mixture in IDLE CUT-OFF and keep the throttle at least  $\frac{3}{4}$  open. Keep turning the engine over with the starter. It will probably start in a matter of seconds.

18. **Warm-Up.** Follow normal procedure, except when extremely cold temperatures make it necessary to dilute the oil further. This is an emergency procedure, to be used only when lack of time prevents a normal engine warm-up.

19. **Carburetor Heat.** Use it during warm-up, on the ground, when outside temperatures are  $-4^{\circ}\text{F}$  ( $-20^{\circ}\text{C}$ ) or below, to help vaporize the fuel. Use it also on the ground when conditions are favorable for carburetor ice to form. But be sure to turn off carburetor heat before takeoff. It is either fully on or off. There is no halfway between point. If left on, it overheats the engines, causes loss of power, and will probably produce detonation.

20. **Accessories.** Check operation of de-icer boots, cowl flaps, intercooler flaps, and other accessories, in the normal manner. Make sure the hot air heaters are off **prior to takeoff**. They may be turned on after the plane is airborne.

### Cold Weather Takeoffs

When you are ready to take off, check to make certain there are no mooring lines, heater hoses, or other entangling devices attached to the airplane. Then taxi slowly to the end of the runway. Be as cautious as if you were driving an automobile on ice.

If there is enough fresh snow to cover the runway, have a ground crew member drive a truck up and down the runway several times. This packs the snow slightly in your takeoff path and outlines the runway so you won't wander off it.

If any covers have been left on the wings, horizontal stabilizers, or elsewhere, because of precipitation, remove them at the end of the runway, before engine run-up.

If your propellers are likely to ice up, turn on the anti-icing control for at least a minute at low engine rpm just before takeoff.

The rest of the pre-takeoff check remains just the same as if you were in California, except for the chatter of your teeth.

Always use  $\frac{1}{3}$  flaps in takeoffs on snow or ice. You want to be airborne as soon as possible, for snow can stretch a takeoff roll to twice its normal length.

Once the plane is in the air, turn all hot air

heaters on immediately. If you need to use the windshield de-froster, and you're flying a P-61A, fasten the de-froster hose in a position where it'll do the most good. In the P-61B's, the windshield de-froster is built in and the control is located on the panel behind the control column.

### Flight Instructions

In flight, operate the landing gear system occasionally to make certain it is not freezing in the UP position. Make the first check shortly after takeoff. Also operate the gun turret from time to time to prevent it from freezing in one position.

If one vacuum pump of your de-icer system fails, the system is built to work effectively on the other. If both pumps fail, or a leak in the line prevents the de-icer boots on one wing from inflating, shut off the de-icer system completely.

### Landings

When landing on ice or snowy runways, come in with flaps extended fully. This not only insures the slowest possible landing speed but shortens the landing roll considerably and gives the brakes less to do.

Always land as nearly into the wind as possible. Crosswind landings are more hazardous on slippery surfaces.

An unbroken expanse of smooth, undrifted snow is as deceptive as calm water to the pilot who's planning to land on it. He can't tell how high he is above the surface. Consequently, unless grass or weeds stick up through the snow and give you a natural depth perception gage, have it understood with the ground crew that if snow falls while you are away on a mission they must drive a truck up and down the runway a few times after the snow stops falling. In addition to outlining the runway for you, these tracks provide just enough of a break in the surface of the snow to enable you to judge your height above it when coming in for a landing.

It is obvious that you must use your brakes cautiously in landing on a slippery runway. The safest procedure is to apply and release them several times rather than to apply steady pres-

## RESTRICTED

sure. The wheels lock easily on slippery surfaces.

### Afterflight Procedure

When the airplane once more is in the parking area, stop the engines and prepare it for its next flight in the normal manner. However, in cold climates, where high winds are frequent, all planes which stand outdoors must be moored. See that the ground crew doesn't neglect this. Park the plane on pine boughs or canvas, to prevent tires from freezing to the ground. In addition, in order that the plane can be made ready for another flight in the shortest possible time, place covers on all surfaces which collect ice and snow. See that the tail booms are covered as well as the engines, propellers, wings, and horizontal stabilizer.

After the brakes have cooled, you can set them for parking without danger of having them lock in that position.

### Protection of Personnel

Arctic flying is much more than a matter of knowing how to prepare a plane for flight in ex-



treme cold, and how to operate it. You've got to know how to **prepare and protect yourself** for living and flying in sub-zero temperatures.

Sweating, for instance, is always dangerous. If your feet or other parts of your body tend to perspire, make sure both your clothing and body are absolutely dry before you go out into extremely cold weather. Under such conditions, ice forms in damp clothing and moist parts of the body freeze almost immediately.

Wear electrically heated clothing **only under fur-lined flying suits and while flying**. This is of great importance. If you have to bail out, or make a forced landing, electrically heated suits alone provide absolutely no protection against the elements. Furthermore, these suits are de-

signed to be worn only as a complete unit, including gloves and footwear. Wear them only under conditions when they are necessary.



Don't use them as pajamas or play suits. The heating element woven into the cloth is delicate and breaks if abused.

The temperature of an electrically heated suit is controlled by a rheostat at the point where the suit plugs into the plane's electrical system. Regulate the temperature of your suit so that you never feel more than comfortably cool. **Sweating absolutely must be avoided.**

Wear the right clothing and enough of it at all times. Spring is the most dangerous time of the year, so far as freezing your body goes. The sun shines brightly and the temperature outdoors gets up as high as 25°F during the day. But as soon as the sun goes down, even though many hours of daylight remain, the temperature drops rapidly. It may get as cold as 50° below zero (F) during the night.

Always wear face masks when the temperatures are extremely low.



There is danger of freezing your lungs if you overexert in temperatures of  $-25^{\circ}\text{F}$  or below. Overexertion causes you to breathe more deeply than usual. To avoid freezing your lungs, if you unintentionally exert yourself enough to start breathing deeply, **put your head down and breathe inside your clothing until you're breathing normally again.**

In extremely low temperatures, maintenance crews must have light tent shelters or heated nose hangars to enable them to work efficiently with tools and equipment. They can insulate metal tools against cold by wrapping the handles with light cord.

**Don't touch any metal part of the airplane without gloves.** In extreme cold, your hands freeze to metal as soon as they touch it and freezing them is a painful process.

Avoid spilling gasoline on your hands or clothing in sub-zero temperatures. It acts some-

what like liquid air, freezing your flesh a few seconds after contact.

You, as pilot, must check before every flight made during winter and beyond the local area of established Arctic bases, to make sure the airplane contains a sleeping bag, emergency rations and matches, mukluks and woolen socks, parka, and emergency kit for everyone aboard.

If you have to make a forced landing, keep your crew close to the plane afterwards. This conserves their energy and makes rescue easier. Never attempt to travel after a forced landing



unless you have adequate equipment and have had previous experience living outdoors in the Arctic in winter. There are only two exceptions to this rule: when you know exactly where you are and shelter or help is within easy reach; and when you know that searchers probably will not reach you.

You can survive many days without food if you relax, keep dry, and get plenty of sleep.

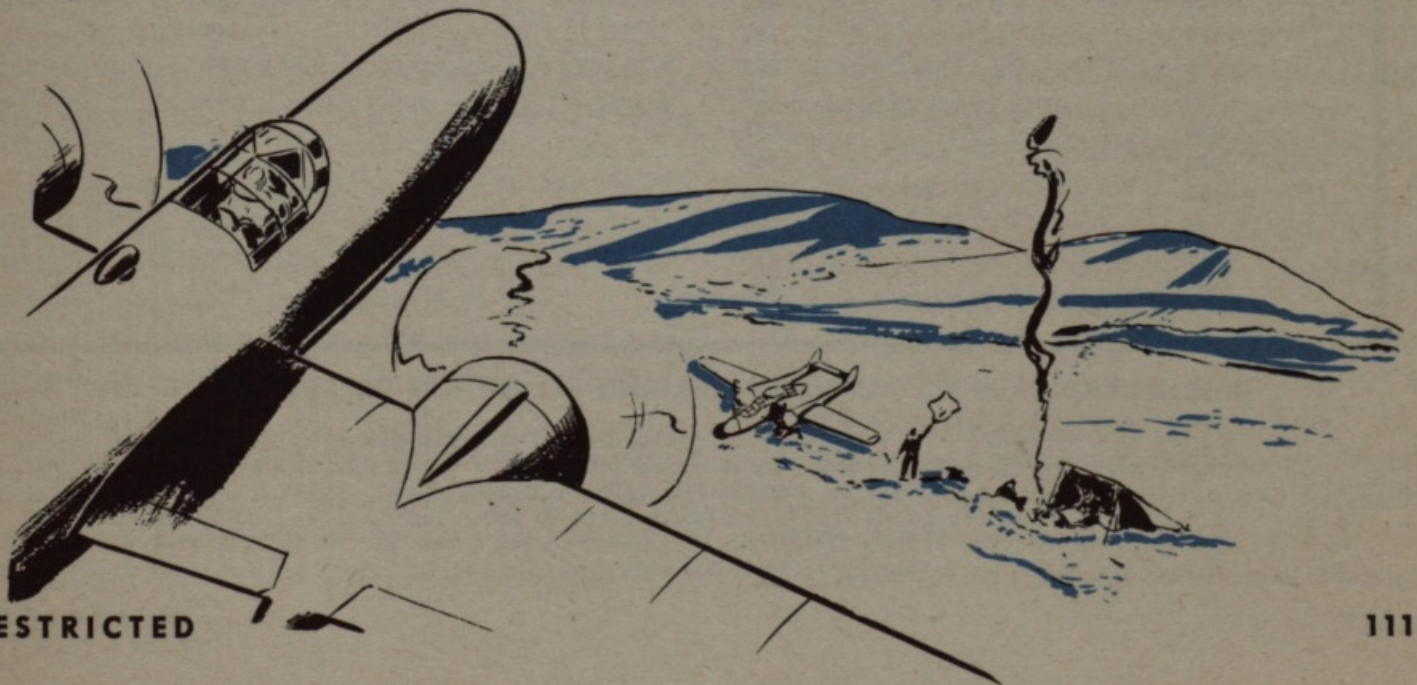



# AIRSPEED CORRECTION CHART

FOR FIRST 100 P-61A'S:\*

CALIBRATED IAS (MPH)	FLAPS UP PILOT'S IAS (MPH)	ALTIMETER CORRECTION (FT.) AT SEA LEVEL†
140	132	81
160	152	86
180	172	90
200	192	96
220	212	104
240	232	114
260	253	126
280	273	141
300	293	157

FOR ALL P-61'S EXCEPT THE FIRST 100

CALIBRATED IAS (MPH)	FLAPS UP PILOT'S IAS (MPH)	ALTIMETER CORRECTION (FT.) AT SEA LEVEL†
100	101	-5
120	122	-10
140	142	-15
160	163	-25
180	183	-40
200	204	-60
220	224	-85
240	245	-110
260	265	-140
280	286	-170
300	306	-210
350	358	-315
400	410	-440

## ADD CORRECTION TO ALTIMETER READING TO OBTAIN PRESSURE ALTITUDE

\*In the first 100 P-61A's the static pressure source is built into the pitot tube on the vertical mast below the nose of the crew nacelle. In all other P-61's the source of static pressure is built into the nose and is flush with the side of it. (Illustrate)

†For all other flight conditions, divide the figure given in this column by the fraction which indicates the relative density of the air (compared to sea level) at the altitude you are flying. For example: divide by  $\frac{1}{2}$  at 18,000 feet.

## HOW TO USE THE CRUISING CONTROL CHART

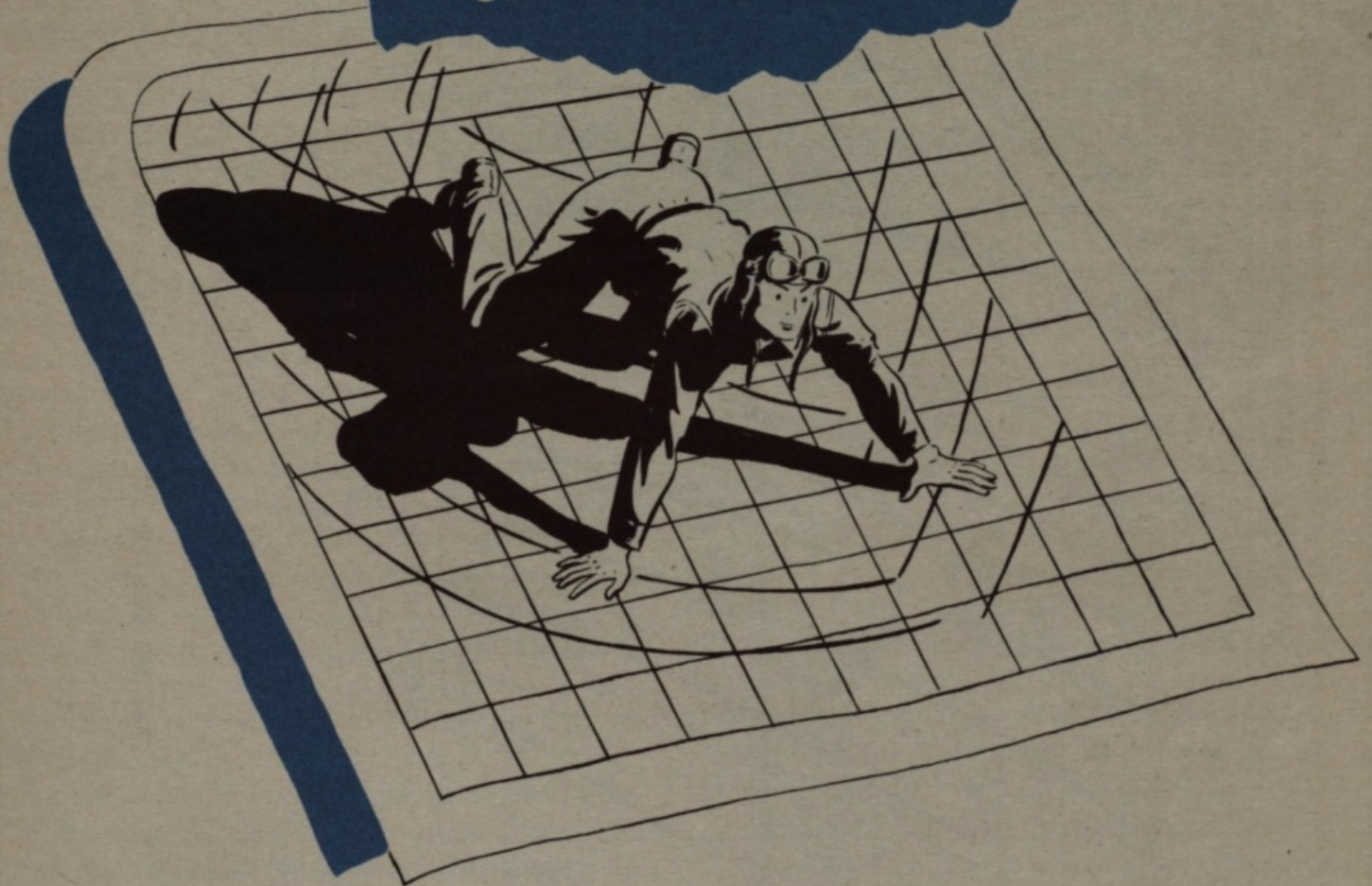

Before you are shown how to use the cruising control chart on the next page you must know these fundamental facts about it:

1. All figures apply to a P-61 cruising with landing gear and flaps fully retracted, cowl and intercooler flaps closed, turret in stowed position, and oil cooler flaps open  $\frac{1}{8}$  to  $\frac{1}{4}$ .

2. Power percentages given are percentages of normal rated power of the engines in neutral blower.

3. The solid, heavy black lines are for constant Hp, except for the line showing normal rated power, and except for the heavy dashed line which shows maximum permissible power

for operation in AUTO LEAN mixture. Those two powers vary with the blower gear ratio.

**Never operate at more than 36.5" Hg. manifold pressure in AUTO LEAN mixture.**

4. The IAS readings are the calibrated values. You have to convert them with the aid of your Airspeed Correction Chart.

5. Fuel flows are shown in the total gallons per hour consumed by both engines. Fuel is computed to weight 5.84 lbs. per gallon.

Now, the best way to understand how to use the cruising control chart is to follow the working out of an example:

Find the power required to cruise at 225 mph



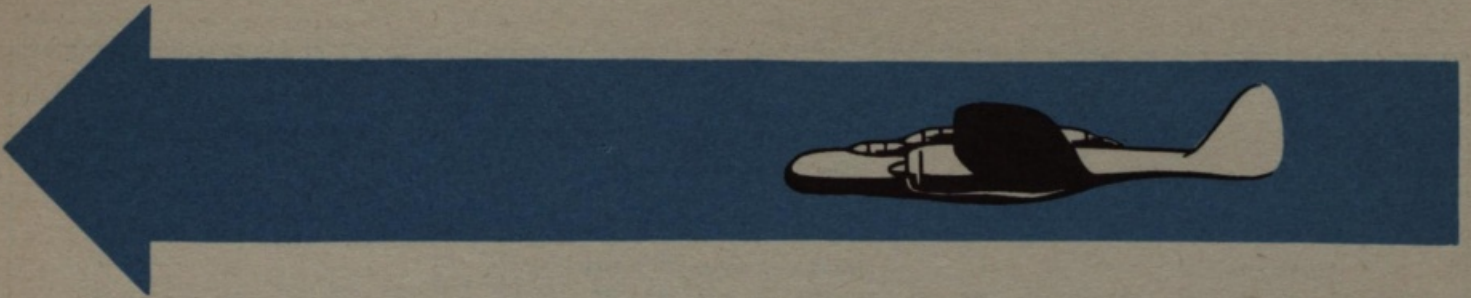

TAS at a temperature of 8°C (47°F) and a pressure altitude of 9000 feet, when the airplane's gross weight is 29,000 lbs.

#### Solution:

Look at the dotted blue line on the chart. It starts from point A, which is approximately your temperature, 8°C. It moves to point B. B is the point at which the straight temperature line intersects the curved line representing a pressure altitude of 9000 feet. You now have your density altitude. By checking the scale at the extreme left of the chart you find this density altitude figure is about 10,200 feet.

The next step is to extend the dotted blue line (now representing density altitude) across the chart from point B until it reaches a point halfway between the light, diagonal lines representing 220 and 230 mph TAS. That's point C, and it represents 225 mph IAS. By checking the scale across the top of the chart you find point C also represents a calibrated IAS of about 192 mph.

If your airplane is one of the first 100 P-61's, the Airspeed Correction Chart on Page 112 shows you 192 mph IAS must be converted to 183 mph IAS to match your instrument reading. If you are flying any other P-61, the Airspeed Correction Chart shows you the calibrated IAS figure must be converted to 196 mph to agree with your instrument reading.

From point C, the blue line drops through point D, which is the base weight of 24,000 lbs. and from there moves parallel to the nearest diagonal line in the bottom extension of the chart, to point E. By checking with the scale at the lower righthand corner of the chart you find point E is approximately equivalent to the gross weight (29,000 lbs.) of the plane in the problem.

Next, move up the blue line from point E to

point F, where you intersect an extension of your density altitude line (running across the chart from point B). Point F is a little more than halfway between the heavy black line representing 45% of normal rated power and the line representing 50% of normal rated power. Consider point F to be the equivalent of 48% power.

Now, you want to find out what power setting you need at your known temperature, weight, and density altitude to achieve 48% power.

Look at the light, dashed, curving line above point F. You'll note that 1800 rpm is printed under it. Note, also, that parallel to this line and below point F there is another light dashed line, marked 1600 rpm. Point F is slightly more than  $\frac{3}{4}$  of the distance between them. We'll say that it calls for a power setting of 1775 rpm in neutral blower. You know that it is in neutral blower because point F is below the double horizontal lines marked NEUTRAL (bottom) and AUX. LO (top).

Now, you want to find out your corresponding manifold pressure. You noted that point F is between the heavy black line representing 45% power and the similar line representing 50% power. Both of them call for full throttle (F.T.) at the altitude of point F.

By checking the figures just under the two black lines to which you have referred, you note that your fuel consumption at this power setting is two-thirds of the way between 115 gallons per hour (gph) and 125 gph, or 123 gph.

#### Putting Chart Readings to Work

All that remains is to translate into action what you've read on the chart. Set your rpm at 1775 and manifold pressure at full throttle (F.T.) to maintain the corrected IAS which, in turn, corresponds to the 225 mph TAS you

# CRUISING CONTROL CHART

P61A, P61B, AIRPLANES (2) R-2800-65 ENGINES

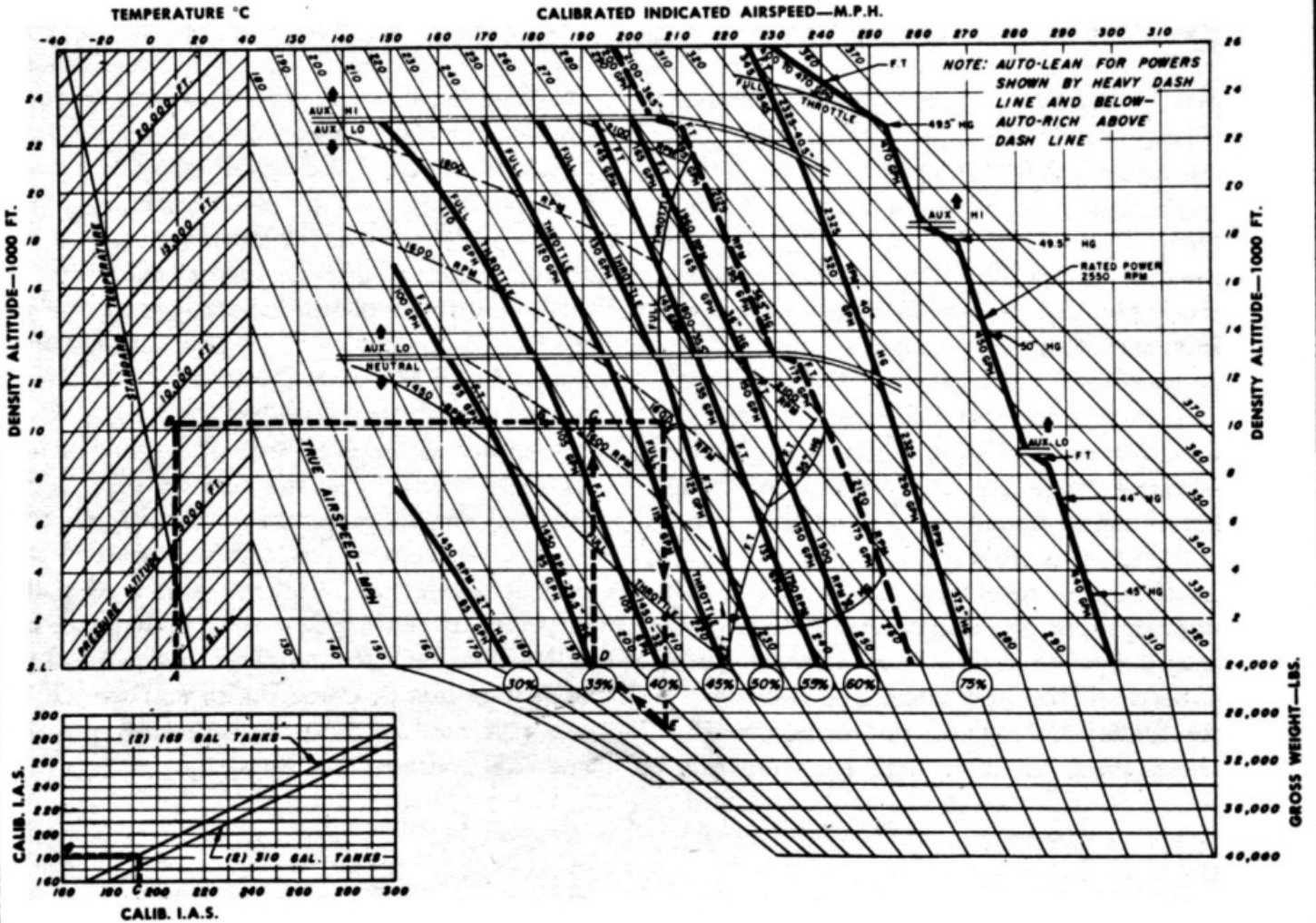

want to achieve. Remember, in hot weather the IAS is low; in cold weather, high, in relation to the chart readings. You have to jockey your power a bit to reach the desired IAS, depending on the temperature.

Increase your rpm to increase your speed, decrease rpm to decrease speed, until you achieve the necessary IAS.

Don't exceed the charted manifold pressure more than 3" Hg. without raising rpm. Don't exceed 2230 rpm for AUTO LEAN operation.

Whenever the chart gives you a choice of two engine speeds, or a choice of two blower gear ratios, use the lower one.

The full throttle points shown by changes in

rpm or blower gear ratios vary with temperature conditions, tending to be at lower altitudes in hot weather, and higher in cold. If you are operating a plane near one of these full throttle points, check to be sure you don't exceed the part-throttle manifold pressure for the desired power.

### Using the Chart in Reverse

Suppose, on the other hand, you want to know how fast you are going to be able to fly at 48% power and a gross weight of 29,000 lbs. You can find the answer quickly by reversing certain procedures used in first reading the cruising control chart.

For instance, you start with point F, where you've already obtained your desired power setting, and move down the dotted blue line to point E representing your plane's gross weight (29,000 lbs.).

From here, move diagonally to point D. Here again, you can read your calibrated IAS (192 mph). Then, by moving vertically up to the density altitude line (point C), you find that your TAS will be 225 mph. You find this out by noting that point C is halfway between the solid, light, curving lines representing 220 mph and 230 mph TAS.

Suppose, with all other conditions remaining the same as in the problem already given, you are flying a P-61 with wing tanks attached.

You were told, on Page 51, that the plane loses about 10 mph IAS for each pair of 165-gal. tanks attached and 20 mph for each pair of 310-gal. tanks. You now can prove that statement by referring to the small correction graph in the lower lefthand corner of Page 114.

Point C on the base line, is the same as Point C on the big chart. In other words, it represents 192 mph IAS, which you found you must maintain to achieve 225 mph TAS.

Move up the dotted line from point C on the correction graph to the solid diagonal line rep-

resenting two 165-gal. tanks. Then, move horizontally to the left until the dotted line intersects the left edge of the correction graph. It intersects that line at 182, an IAS just 10 miles slower than you had before the wing tanks were attached.

Now, look at point G on the big chart. By referring to its position in reference to the light diagonal lines representing TAS, you can quickly find that your TAS has dropped to about 212 mph.

Of course, with wing tanks attached, you are more likely to want to find out how you must change your power setting to maintain your original IAS to 192 mph than you are to want to discover how much IAS you will lose if you don't change the power setting.

To work out this problem, first enter the little correction graph at 192 on the vertical scale. Move horizontally to the right until you intersect the line representing two 165-gal. tanks. Then drop vertically to the base scale. You intersect it at 202 mph. That's your new point C on the big chart. Accordingly, with point C shifted 10 points to the right, the relative positions of points D, E and F also will change. And you can readily read the new power settings and fuel consumption required.

 INDEX

- Absolute (Radio) Altimeter, How to Use, 86  
 Acrobatics, Advice on, 73  
 Acrobatics, How to Perform, 74, 75, 76, 77  
 Acrobatics, Type Permitted and When, 73  
 Acrobatics, When Forbidden, 73  
 Aileron Pressure, 68  
 Airspeed Correction Chart, 112  
 Afterflight Check, 59  
 Afterflight Procedure (Arctic), 110  
 Altimeter Correction Chart, 112  
 Approach Over Obstructions, 62  
 Armor and Armament, 21  
 Automatic Pilot, Operation of, 28, 29
- Bailout, Controlled (Safest), 98  
 Bailout, Quick, 97  
 Blackout Flying, 91  
 Blower, auxiliary, HIGH gear ratio, 11  
 Blower, auxiliary, LOW gear ratio, 11  
 Blower, main, gear ratio, 11  
 Blowers, How to Shift, 69  
 Blowers, How to Test, 44  
 Brakes, Warnings on Use of, 47
- Changes Incorporated in P-61B, 7, 8  
 Checks and Inspections, Importance of, 32  
 Climbing, 69  
 Cockpit Check, 36  
 Controls, Location of, 18, 19, 20  
 Comparison of P-61 and P-70, 9  
 Compression Ratio, 11
- Correction Graph (for Wing Tanks), How to Use, 117  
 Crew Chief, Talking Things Over With, 35  
 Critical Single-Engine Speeds, Table of, 66  
 Cross Country, Pilot's Preparation for, 87, 88, 89  
 Cruising, 70  
 Cruising, Oil and Cylinder-Head Temperatures for, 71  
 Cruising Chart, 114  
 Cruising Chart, Explanation of, 113, 115  
 Cruising Chart, How to Use in Reverse, 116  
 Cruising Chart, Sample Readings from, 70, 71
- Detrola Radio Set, 84  
 Ditching, 99, 100  
 Dives, 72
- Electrically Operated Equipment, List of, 23  
 Emergency Air Brakes, Use of, 101  
 Engines, Description of, 11  
 Engine Failure During Flight, 103  
 Engines, How to Stop After Landing, 59  
 Engine Instrument Check (After Warm-Up), 44  
 Engines, Preheating (Arctic), 108  
 Escape Hatches, 31  
 External Wing Racks, 7
- Fire Extinguishers, 30  
 Fires in Flight, How to Fight, 104, 105  
 Fires While Starting Engines, 43  
 First-Aid Kits, 30

- Flame Damping, 7  
 Flight Instructions (Arctic), 109  
 Flight Instrument Check, 45  
 Form 1-A, Importance of Checking, 35  
 Fuel and Oil System, 14, 15  
 Fuel Consumption, How to Check, 88  
 Fuel Pressure, Allowable, 11  
 Fuel Pressure, Desired, 11  
 Fuel Pressure, Minimum, 11  
 Fuel System Failure in Flight, 103  
 Fuel Transfer System, 16, 17
- Go-Around Procedure, 66  
 Gun Camera, 21  
 Gunsight, Pilot's, 21  
 Gun Sight, Pilot's, 21  
 Gyros, Importance of Uncaging, 49
- History of P-61's Design and Manufacture, 5, 6, 7  
 Headsets and Throat Microphones, 27  
 Heating and Ventilating System, 26  
 How to Get Back on Course, 88, 89  
 Hydraulic System Failure, What to Do in Case of, 101  
 Hydraulic System, Operation of, 24, 25  
 Hydraulically Operated Equipment, List of, 25
- Icing Conditions, What to Do in Case of, 51  
 IAS to TAS, How to Change, 88  
 Instruments, Location of, 18, 19, 20  
 Interception, How to Figure, 94, 95  
 Intruding, Character of, 78, 79
- Lambert Conformal Map, How to Use, 89  
 Landing, Belly, 101, 102  
 Landing, Cold Weather, 109, 110  
 Landing, Crosswind, 63  
 Landing, Full-Flap, 58  
 Landing, Night, 65  
 Landing, No-Flaps, 101  
 Landing, Normal, 56, 57, 58  
 Landing, Power-Off, 60  
 Landing, Short-Field, 61  
 Landing, Single-Engine, 64  
 Landing Gear, Emergency Operation of, 101  
 Landing Gear, How to Check Position of, 25  
 Landing Gear Warning Horn, 25  
 Level Flight with Wheels Down, 56
- Magneto Check (After Warm-Up), 44  
 Maximum Performance, 72  
 Mercator Projection, Facts to Learn About, 89  
 Miscellaneous Equipment, 30  
 Mixture, Advice on, 43  
 Navigation, Pointers on, 87, 88, 89  
 Night Adaptation, How to Accomplish, 81, 82  
 Night Adaptation, How to Preserve (in Flight),  
 Night Adaptation in One Eye, 81, 82  
 Night Binoculars, Use of, 22  
 Night Checks and Inspections, 40  
 Night Navigation, Pointers on, 89, 90, 91
- Oil Dilution of Engines in Arctic, 106, 107  
 Oil Pressure, Desired, 11  
 Oil Pressure, Maximum, 11  
 Oil Pressures, Minimum, 11  
 Oil System Failure in Flight, 104  
 Oil Temperatures, Advice on, 71  
 Oil Temperatures, Desired, 11  
 Oil Temperatures, Maximum, 11  
 Oil Temperatures, Minimum, 11  
 Oxygen, Emergency Use of, 27  
 Oxygen, Normal Use of, 27  
 Oxygen System Failure, 105
- Preflight Check (Arctic), 107, 108  
 Pre-landing Check, 57, 58  
 Pre-starting Check, 36, 37, 38, 39  
 Pre-takeoff Check, 48  
 Prohibited Maneuvers, 72  
 Propeller Check (After Warm-Up), 44  
 Propellers, Description of, 13  
 Propeller Feathering (Emergency), 103  
 Propeller Feathering (Practice), 102  
 Propellers, Fixed Pitch Operation of, 13  
 Propeller Gear Ratio, 11  
 Propeller Unfeathering, 103  
 Protection of Personnel (Arctic), 110, 111  
 Pyrotechnical Equipment (Very pistol, Signal Cartridges, Parachute Flares), 30
- Radio (Absolute) Altimeter, How to Use, 86  
 Radio Compass, How to Use, 85  
 Radio Equipment Pilot Must Know How to Operate, 83, 84  
 Radius of Action to Alternate Base, How to Estimate, 93, 94



## RESTRICTED

Radius of Action to Same Base, How to Estimate, 92

Rendezvous, Preparations for, 95

SCR-695, How to Operate, 86

Seats, 30

Single Engine Failure on Takeoff, 52

Shoulder Harness, 30

Spins, 68

Stalling Speeds, Table of, 66

Stalls, 67

Starting, 41, 42, 43

Starting (Arctic), 108

Structure of P-61, Description of, 10

Switches, Location of, 18, 19, 20

Takeoff, Cold Weather, 109

Takeoff, Crosswind, 53

Takeoff, Night, 55

Takeoff, Normal (With Flaps), 49, 50

Takeoff, Normal (Without Flaps), 50

Takeoff Over Obstacles, 54

Takeoff, Short-Field, 54

TAS to IAS, How to Change, 88

Taxiing, 46, 47

Trimming the Plane, 50

Unconventional Features of Design, 7

VHF Equipment, 84

VHF Equipment, Trouble Shooting on, 86

Visual Inspection, Outside the Airplane, 33, 34

Warm-Up, 43, 44

Warm-Up, Checks to Make During, 44

Water Injection, How to Test, 12

Water Injection, How to Use, 12

Weight and Balance, 66

Why Plane is Painted Shiny Black, 8

Wing Flaps, Operation of, 26

