

INTERIM OPERATIONAL SUPPLEMENT

FLIGHT MANUAL

USAF SERIES T-38C AIRCRAFT

This publication supplements 1T-38C-1, dated 15 June 2008 and will remain active until rescinded or incorporated in the next change. See NOTICE TO AIRCREW below.

COMMANDERS ARE RESPONSIBLE FOR BRINGING THIS PUBLICATION TO THE ATTENTION OF ALL AFFECTED AIR FORCE PERSONNEL. MAJCOMS, SOAS, AND DRUS ARE RESPONSIBLE FOR RETRANSMITTING THIS PUBLICATION TO SUBORDINATE UNITS. IT WILL REMAIN IN EFFECT UNTIL FORMALLY PUBLISHED OR RESCINDED.

DISTRIBUTION STATEMENT E - Distribution authorized to DoD Components only for unclassified and classified technical data. (27 October 2008). Other requests for this document shall be referred to OO-ALC/538 ACSG/ENJ, 6057 Box Elder Lane, Hill AFB, UT 84056-5811.

EXPORT CONTROL WARNING - This document contains technical data whose export is restricted by the Arms Export Control Act (Title 22, U.S.C., Sec. 2751 et seq.) or the Export Administration Act of 1979, as amended (Title 50, U.S.C., App. 2401 et seq.). Violations of these export laws are subject to severe criminal penalties. Disseminate in accordance with provisions of DOD Directive 5230.25.

HANDLING AND DESTRUCTION NOTICE - Unclassified/Limited Distribution documents shall be handled using the same standard as "For Official Use Only (FOUO)" material, and will be destroyed in any method that will prevent disclosure of the contents or reconstruction of the document.

Published under authority of the Secretary of the Air Force

27 OCTOBER 2008

Title: Exterior Inspection Caution

1. NOTICE TO AIRCREW: File this supplement in the front of the flight manual.
2. PURPOSE: This supplement is issued to amend the basic publication. This supplement will remain in effect until incorporated into the next change or rescinded.
3. GENERAL: Adds a CAUTION to the Exterior Inspection to prevent potential flight control system damage.

TO 1T-38C-1S-03

4. INSTRUCTIONS: Write the number of this supplement alongside the changed portion of the flight manual. Pencil write-ins are authorized to accomplish the instructions of this supplement.

A. In 1T-38C-1, on page 2-5, EXTERIOR INSPECTION, add a CAUTION to read:

“CAUTION
Excessive force applied to the aileron surface may damage the aileron operating mechanism.”

5. STATUS INFORMATION:

A. Checklist: 1T-38C-1CL-1 dated 15 June 08

B. Outstanding Supplements:

Number	Date	Title	Status	Checklist Affected?
1T-38C-1S-03	27 Oct 08	Exterior Inspection Caution	Current	No
1T-38C-1S-02	27 Oct 08	Starting Engines Oil Indications	Current	Yes
1T-38C-1SS-01	27 Oct 08	Flight Control Check	Current	Yes

6. POCs for this publication are:

	Flight Manual Manager	TO Manager (TOMA)
NAME:	Gene Halsall	Dave Thompson
UNIT:	OO-ALC/558 ACSG/ENJ	OO-ALC/506 ACSS/GFLA
DSN:	586-3235	"CAUTION
COMM:	(801) 586-3235	Excessive force applied
E-MAIL:	Gene.Halsall@Hill.af.mil	to the aileron surface Hill.af.mil

7. This IOS was coordinated with HQ AETC/A3, AFMC/A3V and approved by the T-38 SPM. may damage the aileron operating mechanism." }

INTERIM OPERATIONAL SUPPLEMENT

FLIGHT MANUAL

USAF SERIES T-38C AIRCRAFT

The Boeing Company
F33657-95-C-0057
FA8617-04-C-6153

This publication supplements 1T-38C-1, dated 15 June 2008, and will remain active until rescinded or incorporated in the next change. See NOTICE TO AIRMEN below.

COMMANDERS ARE RESPONSIBLE FOR BRINGING THIS PUBLICATION TO THE ATTENTION OF ALL AFFECTED AIR FORCE PERSONNEL. MAJCOMS, SOAS, AND DRUS ARE RESPONSIBLE FOR RETRANSMITTING THIS PUBLICATION TO SUBORDINATE UNITS. IT WILL REMAIN IN EFFECT UNTIL FORMALLY PUBLISHED OR RESCINDED.

DISTRIBUTION STATEMENT - Distribution authorized to US government agencies and their contractors for administrative and/or operational use; 27 October 2008. Other requests for this document shall be referred to 558 ACSG/ENJ, 6057 Box Elder Lane, Hill AFB, UT 84056-5826.

EXPORT CONTROL WARNING - This document contains technical data whose export is restricted by the Arms Export Control Act (Title 22, U.S.C., Sec. 2751 et seq.) or the Export Administration Act of 1979, as amended (Title 50, U.S.C., App. 2401 et seq.). Violations of these export laws are subject to severe criminal penalties. Disseminate in accordance with provisions of DOD Directive 5230.25.

HANDLING AND DESTRUCTION NOTICE - Unclassified/Limited Distribution documents shall be handled using the same standard as "For Official Use Only (FOUO)" material, and will be destroyed in any method that will prevent disclosure of the contents or reconstruction of the document.

Published under authority of the Secretary of the Air Force

27 OCTOBER 2008

Title: STARTING ENGINE OIL INDICATIONS

1. NOTICE TO AIRCREW: File this supplement in the front of the flight manual.
2. PURPOSE: This supplement is issued to amend the basic publication and checklist. This supplement will remain in effect until incorporated into the next change or rescinded.
3. GENERAL: This supplement is to clarify that during engine start the throttle should not be advance *above* IDLE without a positive (>0) oil pressure indication. Updates checklist appropriately.

T.O. 1T-38C-1S-02

4. INSTRUCTIONS: Write the number of this supplement alongside the changed portion of the flight manual. Pencil write-ins are authorized to accomplish the instructions of this supplement. Attached pages for the 1T-38C-1CL-1 may be reproduced and inserted.

A. In 1T-38C-1, on page 2-23, STARTING ENGINES, Right Engine, step 5, change first bullet to the CAUTION to read:

CAUTION

- Do not advance throttle above IDLE without a positive (>0) indication of oil pressure.

B. In 1T-38C-1, on page 5-6, Figure 5-3, ENGINE OPERATING LIMITATIONS, GROUND STEADY STATE and FLIGHT STEADY STATE, change both START OIL PRESSURE PSI ">0" to read: "- - -".

C. In 1T-38C-1CL-1, on page N-24, STARTING ENGINES, Right Engine, step 4, change to read:

4. EED – CHECK EGT NOT FAILED, CHECK OIL PRESSURE NOT FAILED.

D. In 1T-38C-1CL-1, on page N-24, STARTING ENGINES, Right Engine, step 5, change first bullet to the CAUTION to read:

CAUTION

- Do not advance throttle above IDLE without a positive (>0) indication of oil pressure.

E. In 1T-38C-1CL-1 on page EG-3, ENGINE OPERATING LIMITATIONS, GROUND STEADY STATE and FLIGHT STEADY STATE, change both START OIL PRESSURE PSI ">0" to read: "- - -".

5. STATUS INFORMATION:

A. Checklist: 1T-38C-1CL-1 dated 15 June 08

B. Outstanding Supplements:

Number	Date	Title	Status	Checklist Affected?
1T-38C-1S-02	27 Oct 08	Starting Engines Oil Indications	Current	Yes
1T-38C-1SS-01	27 Oct 08	Flight Control Check	Current	Yes

6. POCs for this publication are:

	Flight Manual Manager	TO Manager (TOMA)
NAME:	Gene Halsall	Dave Thompson
UNIT:	OO-ALC/558 ACSG/ENJ	OO-ALC/506 ACSS/GFLA
DSN:	586-3235	775-3217
COMM:	(801) 586-3235	(801) 775-3217
E-MAIL:	Gene.Halsall@Hill.af.mil	Duane.Thompson@Hill.af.mil

7. This ISS was coordinated with HQ AETC/A3FV and approved/released by the T-38C SPM.

INTERIM SAFETY SUPPLEMENT

FLIGHT MANUAL

USAF SERIES T-38C AIRCRAFT

The Boeing Company
F33657-95-C-0057
FA8617-04-C-6153

This publication supplements 1T-38C-1, dated 15 June August 2008, and will remain active until rescinded or incorporated in the next change. See NOTICE TO AIRMEN below.

COMMANDERS ARE RESPONSIBLE FOR BRINGING THIS PUBLICATION TO THE ATTENTION OF ALL AFFECTED AIR FORCE PERSONNEL. MAJCOMS, SOAS, AND DRUS ARE RESPONSIBLE FOR RETRANSMITTING THIS PUBLICATION TO SUBORDINATE UNITS. IT WILL REMAIN IN EFFECT UNTIL FORMALLY PUBLISHED OR RESCINDED.

DISTRIBUTION STATEMENT - Distribution authorized to US government agencies and their contractors for administrative and/or operational use; 27 October 2008. Other requests for this document shall be referred to 558 ACSG/ENJ, 6057 Box Elder Lane, Hill AFB, UT 84056-5826.

EXPORT CONTROL WARNING - This document contains technical data whose export is restricted by the Arms Export Control Act (Title 22, U.S.C., Sec. 2751 et seq.) or the Export Administration Act of 1979, as amended (Title 50, U.S.C., App. 2401 et seq.). Violations of these export laws are subject to severe criminal penalties. Disseminate in accordance with provisions of DOD Directive 5230.25.

HANDLING AND DESTRUCTION NOTICE - Unclassified/Limited Distribution documents shall be handled using the same standard as "For Official Use Only (FOUO)" material, and will be destroyed in any method that will prevent disclosure of the contents or reconstruction of the document.

Published under authority of the Secretary of the Air Force

27 OCTOBER 2008

Title: FLIGHT CONTROL CHECK

1. NOTICE TO AIRCREW: File this supplement in the front of the flight manual.
2. PURPOSE: This supplement is issued to amend the basic publication and checklist. This supplement will remain in effect until incorporated into the next change or rescinded.
3. GENERAL: Changes three normal procedures steps and their WARNINGS and adds NOTES in two. Adds a WARNING to Section III – RUDDER SYSTEM MALFUNCTIONS. Updates checklist appropriately.

T.O. 1T-38C-1SS-01

4. INSTRUCTIONS: Write the number of this supplement alongside the changed portion of the flight manual. Pencil write-ins are authorized to accomplish the instructions of this supplement. Attached pages for the 1T-38C-1CL-1 may be reproduced and inserted.

A. In 1T-38C-1, on page 2-17, left column, BEFORE TAXIING, step 5, change step and WARNING to read:

5. Flight control surfaces – CHECK

Visually confirm free and proper movement of flight control surfaces, and that rudder and ailerons return to neutral at completion of flight control checks.

WARNING

Due to the artificial feel assembly, some flight control failure modes will allow a flight control surface (rudder and ailerons) to remain displaced with no warning to the crew when the controls are returned to neutral.

B. In 1T-38C-1, on page 2-17, left column, BEFORE TAXIING, step 5, after WARNING add new NOTE to read:

NOTE

With normal movement, hydraulic pressure should not drop below 1500 PSI.

C. In 1T-38C-1, on page 2-23, right column, BEFORE TAXIING, step 4, change step and WARNING to read:

4. Flight control surfaces – CHECK

Visually confirm free and proper movement of flight control surfaces, and that rudder and ailerons return to neutral at completion of flight control checks.

WARNING

Due to the artificial feel assembly, some flight control failure modes will allow a flight control surface (rudder and ailerons) to remain displaced with no warning to the crew when the controls are returned to neutral.

D. In 1T-38C-1, on page 2-23, left column, BEFORE TAXIING, step 4, after WARNING add new NOTE to read:

NOTE

With normal movement, hydraulic pressure should not drop below 1500 PSI.

E. In 1T-38C-1, on page 2-26, left column, BEFORE TAKEOFF, step 7, change step and WARNING to read:

7. Flight control surfaces – CHECK

Visually confirm free and proper movement of flight control surfaces, and that rudder and ailerons return to neutral at completion of flight control checks.

WARNING

Due to the artificial feel assembly, some flight control failure modes will allow a flight control surface (rudder and ailerons) to remain displaced with no warning to the crew when the controls are returned to neutral.

F. In 1T-38C-1, on page 2-26, left column, BEFORE TAKEOFF, step 7, after WARNING, add new NOTE to read:

NOTE

Accomplish this task as close as possible to takeoff.

G. In 1T-38C-1, on page 3-51, right column, RUDDER SYSTEM MALFUNCTIONS, add WARNING to read:

WARNING

- A flight control malfunction can result in an unrecoverable loss of aircraft control immediately after liftoff. If a flight control malfunction is suspected during takeoff roll, consider a high speed abort or ejection.

T.O. 1T-38C-1SS-01

- Do not confuse other flight control malfunctions with a hard-over rudder. If a hard-over rudder malfunction is suspected, but aircraft roll can be controlled with opposite aileron and/or rudder input, suspect an aileron or flap system malfunction instead.
- Available rudder authority with the landing gear down is sufficient to create a short-duration loss of roll stability resulting in rapid roll acceleration. Excessive rudder inputs will increase the time and altitude required to recover.

H. In 1T-38C-1CL-1, on page N-16, BEFORE TAXIING, step 5 change step and WARNING to read:

5. Flight control surfaces – CHECK

WARNING

Due to the artificial feel assembly, some flight control failure modes will allow a flight control surface (rudder and ailerons) to remain displaced with no warning to the crew when the controls are returned to neutral.

I. In 1T-38C-1CL-1, on page N-25, BEFORE TAXIING, step 4 change step and WARNING to read:

4. Flight control surfaces – CHECK

WARNING

Due to the artificial feel assembly, some flight control failure modes will allow a flight control surface (rudder and ailerons) to remain displaced with no warning to the crew when the controls are returned to neutral.

J. In 1T-38C-1CL-1, on page N-29, BEFORE TAKEOFF, step 7, change step and WARNING to read:

*7. Flight control surfaces – CHECK

WARNING

Due to the artificial feel assembly, some flight control failure modes will allow a flight control surface (rudder and ailerons) to remain displaced with no warning to the crew when the controls are returned to neutral.

5. STATUS INFORMATION:

A. Checklist: 1T-38C-1CL-1 dated 15 June 08

B. Outstanding Supplements:

Number	Date	Title	Status	Checklist Affected?
1T-38C-1SS-01	27 Oct 08	Flight Control Check	Current	Yes

6. POCs for this publication are:

	Flight Manual Manager	TO Manager (TOMA)
NAME:	Gene Halsall	Dave Thompson
UNIT:	OO-ALC/558 ACSG/ENJ	OO-ALC/506 ACSS/GFLA
DSN:	586-3235	775-3217
COMM:	(801) 586-3235	(801) 775-3217
E-MAIL:	Gene.Halsall@Hill.af.mil	Duane.Thompson@Hill.af.mil

7. This ISS was coordinated with HQ AETC/A3FV and approved/released by the T-38C SPM.

FLIGHT MANUAL

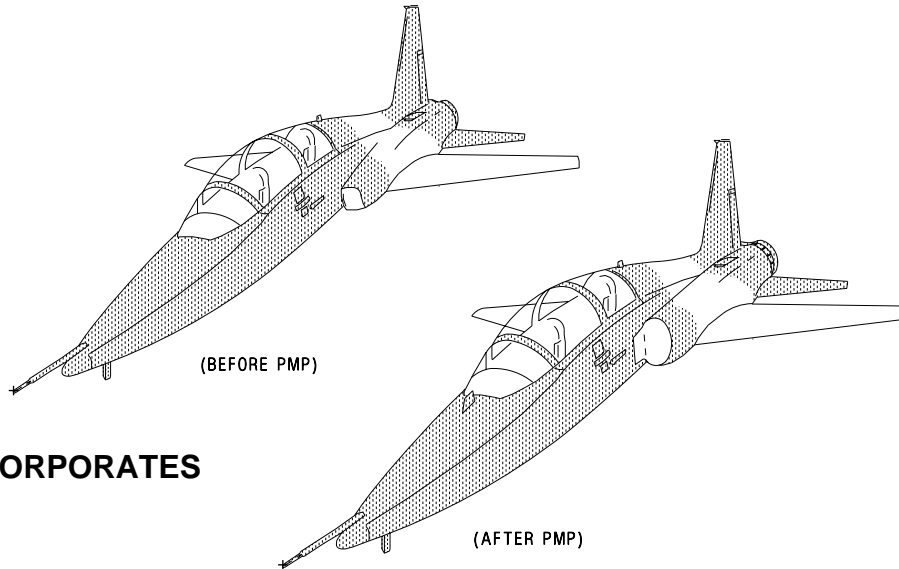

T38002-57-1-012

THIS MANUAL INCORPORATES THE FOLLOWING:

1T-38C-1SS-01
1T-38C-1S-02
1T-38C-1S-03

USAF SERIES T-38C AIRCRAFT

The Boeing Company
F33657-95-C-0057, FA8617-04-C-6153

This manual supersedes T.O. 1T-38C-1 dated 1 April 2001 thru Change 11 dated 1 May 2007 and incorporates supplements: 1T-38C-1S-26 (28 Sept 2007), 1T-38C-1SS-27 (5 Dec 2007), 1T-38C-1S-28 (28 DEC 2007), 1T-38C-1S-29 (7 Jan 2008).

This manual is incomplete without T.O. 1T-38C-1-1.

DISCLOSURE NOTICE - This information is furnished on the conditions that it will not be released to another nation without the specific authorization of the Department of the Air Force of the United States; it will be used for military purposes only, that individual and corporate rights originating in the information, whether patented or not, will be respected, that the recipient will report promptly to the United States, any known or suspected compromise, and that the information will be provided substantially the same degree of security afforded it by the Department of Defense of the United States. Also, regardless of any other markings on the document, it will not be downgraded or declassified without the written approval of the originating United States agency.

DISTRIBUTION STATEMENT - Distribution authorized to the Department of Defense and U.S. DoD contractors only. (Administrative and Operational), 15 JUNE 2008. Other requests for this document shall be referred to OO-ALC/558 ACSG/ENE, 6057 Box Elder Lane, Hill AFB UT 84056-5811.

WARNING - This document contains technical data whose export is restricted by the Arms Export Control Act (Title 22, U.S.C., sec 2751 *et seq.*) or the Export Administration Act of 1979, as amended, Title 50, U.S.C., app. 2401 *et seq.* Violations of these export laws are subject to severe criminal penalties. Disseminate in accordance with provisions of AFI 61-204.

HANDLING AND DESTRUCTION NOTICE - Comply with Distribution Statement and destroy by any method that will prevent disclosure of the contents or reconstruction of the document.

Commanders are responsible for bringing this publication to the attention of all affected personnel.
Published under authority of the Secretary of the Air Force.

LIST OF EFFECTIVE PAGES

Insert latest changed pages; dispose of superseded pages in accordance with applicable regulations.

Dates of issue for original and changed pages:

Original 015 Jun 08

Total number of pages in this publication is 620 consisting of the following:

Page No.	#Change No.	Page No.	#Change No.	Page No.	#Change No.	Page No.	#Change No.
Title	0	1-32	0	1-75	0	1-118	0
A	0	1-33	0	1-76	0	1-119	0
B	0	1-34	0	1-77	0	1-120	0
C	0	1-35	0	1-78	0	1-121	0
i	0	1-36	0	1-79	0	1-122	0
ii blank	0	1-37	0	1-80	0	1-123	0
iii	0	1-38	0	1-81	0	1-124	0
iv	0	1-39	0	1-82	0	1-125	0
v	0	1-40	0	1-83	0	1-126	0
vi	0	1-41	0	1-84	0	1-127	0
vii	0	1-42	0	1-85	0	1-128	0
viii	0	1-43	0	1-86	0	1-129	0
1-1	0	1-44	0	1-87	0	1-130	0
1-2	0	1-45	0	1-88	0	1-131	0
1-3	0	1-46	0	1-89	0	1-132	0
1-4	0	1-47	0	1-90	0	1-133	0
1-5	0	1-48	0	1-91	0	1-134	0
1-6	0	1-49	0	1-92	0	1-135	0
1-7	0	1-50	0	1-93	0	1-136	0
1-8	0	1-51	0	1-94	0	1-137	0
1-9	0	1-52	0	1-95	0	1-138	0
1-10	0	1-53	0	1-96	0	1-139	0
1-11	0	1-54	0	1-97	0	1-140	0
1-12	0	1-55	0	1-98	0	1-141	0
1-13	0	1-56	0	1-99	0	1-142	0
1-14	0	1-57	0	1-100	0	1-143	0
1-15	0	1-58	0	1-101	0	1-144	0
1-16	0	1-59	0	1-102	0	1-145	0
1-17	0	1-60	0	1-103	0	1-146	0
1-18	0	1-61	0	1-104	0	1-147	0
1-19	0	1-62	0	1-105	0	1-148	0
1-20	0	1-63	0	1-106	0	1-149	0
1-21	0	1-64	0	1-107	0	1-150	0
1-22	0	1-65	0	1-108	0	1-151	0
1-23	0	1-66	0	1-109	0	1-152	0
1-24	0	1-67	0	1-110	0	1-153	0
1-25	0	1-68	0	1-111	0	1-154	0
1-26	0	1-69	0	1-112	0	1-155	0
1-27	0	1-70	0	1-113	0	1-156	0
1-28	0	1-71	0	1-114	0	1-157	0
1-29	0	1-72	0	1-115	0	1-158	0
1-30	0	1-73	0	1-116	0	1-159	0
1-31	0	1-74	0	1-117	0	1-160	0

#Zero in this column indicates an original page.

Page No.	#Change No.	Page No.	#Change No.	Page No.	#Change No.	Page No.	#Change No.
1-161	0	1-222	0	1-283	0	1-344	0
1-162	0	1-223	0	1-284	0	1-345	0
1-163	0	1-224	0	1-285	0	1-346	0
1-164	0	1-225	0	1-286	0	1-347	0
1-165	0	1-226	0	1-287	0	1-348	0
1-166	0	1-227	0	1-288	0	1-349	0
1-167	0	1-228	0	1-289	0	1-350	0
1-168	0	1-229	0	1-290	0	1-351	0
1-169	0	1-230	0	1-291	0	1-352	0
1-170	0	1-231	0	1-292	0	1-353	0
1-171	0	1-232	0	1-293	0	1-354	0
1-172	0	1-233	0	1-294	0	1-355	0
1-173	0	1-234	0	1-295	0	1-356	0
1-174	0	1-235	0	1-296	0	1-357	0
1-175	0	1-236	0	1-297	0	1-358	0
1-176	0	1-237	0	1-298	0	1-359	0
1-177	0	1-238	0	1-299	0	1-360	0
1-178	0	1-239	0	1-300	0	1-361	0
1-179	0	1-240	0	1-301	0	1-362	0
1-180	0	1-241	0	1-302	0	1-363	0
1-181	0	1-242	0	1-303	0	1-364	0
1-182	0	1-243	0	1-304	0	1-365	0
1-183	0	1-244	0	1-305	0	1-366	0
1-184	0	1-245	0	1-306	0	1-367	0
1-185	0	1-246	0	1-307	0	1-368	0
1-186	0	1-247	0	1-308	0	1-369	0
1-187	0	1-248	0	1-309	0	1-370	0
1-188	0	1-249	0	1-310	0	1-371	0
1-189	0	1-250	0	1-311	0	1-372	0
1-190	0	1-251	0	1-312	0	1-373	0
1-191	0	1-252	0	1-313	0	1-374	0
1-192	0	1-253	0	1-314	0	1-375	0
1-193	0	1-254	0	1-315	0	1-376	0
1-194	0	1-255	0	1-316	0	1-377	0
1-195	0	1-256	0	1-317	0	1-378	0
1-196	0	1-257	0	1-318	0	1-379	0
1-197	0	1-258	0	1-319	0	1-380	0
1-198	0	1-259	0	1-320	0	1-381	0
1-199	0	1-260	0	1-321	0	1-382	0
1-200	0	1-261	0	1-322	0	1-383	0
1-201	0	1-262	0	1-323	0	1-384	0
1-202	0	1-263	0	1-324	0	1-385	0
1-203	0	1-264	0	1-325	0	1-386	0
1-204	0	1-265	0	1-326	0	1-387	0
1-205	0	1-266	0	1-327	0	1-388	0
1-206	0	1-267	0	1-328	0	1-389	0
1-207	0	1-268	0	1-329	0	1-390	0
1-208	0	1-269	0	1-330	0	1-391	0
1-209	0	1-270	0	1-331	0	1-392	0
1-210	0	1-271	0	1-332	0	1-393	0
1-211	0	1-272	0	1-333	0	1-394	0
1-212	0	1-273	0	1-334	0	1-395	0
1-213	0	1-274	0	1-335	0	1-396	0
1-214	0	1-275	0	1-336	0	1-397	0
1-215	0	1-276	0	1-337	0	1-398 blank	0
1-216	0	1-277	0	1-338	0	2-1	0
1-217	0	1-278	0	1-339	0	2-2	0
1-218	0	1-279	0	1-340	0	2-3	0
1-219	0	1-280	0	1-341	0	2-4	0
1-220	0	1-281	0	1-342	0	2-5	0
1-221	0	1-282	0	1-343	0	2-6	0

#Zero in this column indicates an original page.

T.O. 1T-38C-1

Page No.	#Change No.	Page No.	#Change No.	Page No.	#Change No.	Page No.	#Change No.
2-7	0	3-24	0	3-85	0	FP-24 blank	0
2-8	0	3-25	0	3-86	0	FP-25	0
2-9	0	3-26	0	3-87	0	FP-26 blank	0
2-10	0	3-27	0	3-88	0	Glossary 1	0
2-11	0	3-28	0	3-89	0	Glossary 2	0
2-12	0	3-29	0	3-90	0	Glossary 3	0
2-13	0	3-30	0	3-91	0	Glossary 4	0
2-14	0	3-31	0	3-92	0	Glossary 5	0
2-15	0	3-32	0	4-1	0	Glossary 6	0
2-16	0	3-33	0	4-2 blank	0	Index 1	0
2-17	0	3-34	0	5-1	0	Index 2	0
2-18	0	3-35	0	5-2	0	Index 3	0
2-19	0	3-36	0	5-3	0	Index 4	0
2-20	0	3-37	0	5-4	0	Index 5	0
2-21	0	3-38	0	5-5	0	Index 6	0
2-22	0	3-39	0	5-6	0	Index 7	0
2-23	0	3-40	0	5-7	0	Index 8	0
2-24	0	3-41	0	5-8	0	Index 9	0
2-25	0	3-42	0	5-9	0	Index 10	0
2-26	0	3-43	0	5-10	0	Index 11	0
2-27	0	3-44	0	5-11	0	Index 12 blank	0
2-28	0	3-45	0	5-12 blank	0		
2-29	0	3-46	0	6-1	0		
2-30	0	3-47	0	6-2	0		
2-31	0	3-48	0	6-3	0		
2-32	0	3-49	0	6-4	0		
2-33	0	3-50	0	6-5	0		
2-34	0	3-51	0	6-6	0		
2-35	0	3-52	0	6-7	0		
2-36	0	3-53	0	6-8	0		
2-37	0	3-54	0	6-9	0		
2-38	0	3-55	0	6-10	0		
2-39	0	3-56	0	6-11	0		
2-40	0	3-57	0	6-12	0		
2-41	0	3-58	0	7-1	0		
2-42	0	3-59	0	7-2	0		
2-43	0	3-60	0	7-3	0		
2-44	0	3-61	0	7-4	0		
3-1	0	3-62	0	FP-1	0		
3-2	0	3-63	0	FP-2 blank	0		
3-3	0	3-64	0	FP-3	0		
3-4	0	3-65	0	FP-4 blank	0		
3-5	0	3-66	0	FP-5	0		
3-6	0	3-67	0	FP-6 blank	0		
3-7	0	3-68	0	FP-7	0		
3-8	0	3-69	0	FP-8 blank	0		
3-9	0	3-70	0	FP-9	0		
3-10	0	3-71	0	FP-10 blank	0		
3-11	0	3-72	0	FP-11	0		
3-12	0	3-73	0	FP-12 blank	0		
3-13	0	3-74	0	FP-13	0		
3-14	0	3-75	0	FP-14 blank	0		
3-15	0	3-76	0	FP-15	0		
3-16	0	3-77	0	FP-16 blank	0		
3-17	0	3-78	0	FP-17	0		
3-18	0	3-79	0	FP-18 blank	0		
3-19	0	3-80	0	FP-19	0		
3-20	0	3-81	0	FP-20 blank	0		
3-21	0	3-82	0	FP-21	0		
3-22	0	3-83	0	FP-22 blank	0		
3-23	0	3-84	0	FP-23	0		

#Zero in this column indicates an original page.

TABLE OF CONTENTS

SECTION	TITLE	PAGE
SECTION I	DESCRIPTION AND OPERATION	1-1
SECTION II	NORMAL PROCEDURES	2-1
SECTION III	EMERGENCY PROCEDURES.....	3-1
SECTION IV	CREW DUTIES AND PROCEDURES	4-1
SECTION V	OPERATING LIMITATIONS.....	5-1
SECTION VI	FLIGHT CHARACTERISTICS.....	6-1
SECTION VII	ADVERSE WEATHER OPERATION.....	7-1
	FOLDOUT ILLUSTRATIONS	FP-1
	GLOSSARY.....	Glossary 1
	ALPHABETICAL INDEX	Index 1

INTRODUCTION

SCOPE

This manual contains all the information for safe and efficient operation of T-38C aircraft. These instructions provide you with a general knowledge of the aircraft, its characteristics, and specific normal and emergency operating procedures. Instructions in this manual are for a pilot inexperienced in the operation of this aircraft. This manual provides the best possible operating instructions under most circumstances. Multiple emergencies, adverse weather, terrain, etc., may require modification of the procedures; however, this does not alleviate the need for sound judgment in your operation of the aircraft.

PERMISSIBLE OPERATIONS

The flight manual takes a positive approach and normally states only what you can do. Unusual operations or configurations which exceed the limitations as specified in this manual are prohibited unless specifically covered herein. Clearance must be obtained from the respective MAJCOM before any questionable operation is attempted which is not specifically permitted in this manual is attempted.

HOW TO BE ASSURED OF HAVING LATEST DATA

Refer to T.O. 0-1-1-5 for a listing of all current flight manuals, safety supplements, operational supplements, and checklists. Also, check the flight manual title page, the title block of each safety and operational supplement and the latest status pages contained in the flight manual or attached to formal safety and operational supplements.

ARRANGEMENT

This flight manual is divided into seven independent sections to simplify straight through reading or as a reference manual. The flight manual contains itemized procedures with necessary amplifications. Refer to T.O. 1T-38C-1-1 for BEFORE PMP and AFTER PMP PERFORMANCE DATA.

CHECKLISTS

The checklist contains itemized procedures. Amplifications may be included, but shall be kept to a minimum. Whenever a supplement affects the abbreviated checklist, write in the applicable change on the

affected checklist page or if a checklist page is included, insert it into your checklist. Refer to T.O. 1T-38C-1-1CL-1 for BEFORE PMP and AFTER PMP PERFORMANCE DATA.

HOW TO GET PERSONAL COPIES

Each flight crew member is entitled to personal copies of the flight manual, supplements and checklist. Your publication distribution officer should be contacted to fill your technical order request. T.O. 00-5-1 and T.O. 00-5-2 gives detailed information for ordering publications.

CHANGE SYMBOLS

Changed text is indicated by a black vertical line in either margin of the page. The black vertical line appears adjacent to the text/figure that has changed or removed as in the case of a deleted paragraph.

TIME COMPLIANCE TECHNICAL ORDER (TCTO) SUMMARY

The TCTO Summary contains all current technical directives that have been incorporated in any one or all T-38C-1 series manuals. The directives are repeated in a comparable list in those manuals where the data is actually described. When a directive is rescinded or complete, the TO number will be deleted from this table and any reference to the number will be deleted from the text.

SAFETY SUPPLEMENTS

Information involving safety of flight items will be promptly forwarded to you. Supplements can be issued electronically encrypted (interim), by printed copy (formal), or placed on the Community of Practice website for immediate notification/distribution by Wing Stan/Eval officers, depending upon the urgency. Supplements are numbered consecutively regardless of whether it is safety or operational. File supplements in reverse numerical order in the front of the flight manual.

OPERATIONAL SUPPLEMENTS

Information involving changes to operating procedures will be promptly forwarded to you. Supplements can be issued electronically encrypted

T.O. 1T-38C-1

(interim), by printed copy (formal), or placed on the Community of Practice website for immediate notification/distribution by Wing Stan/Eval officers, depending upon the urgency. Supplements are numbered consecutively regardless of whether it is safety or operational. The procedure for handling operational supplements is the same as for safety supplements.

WARNINGS, CAUTIONS AND NOTES

For your information, the following definitions apply to the Warnings, Cautions and Notes found throughout the manual:



Operating procedures, practices, etc., which could result in personal injury or loss of life if not carefully followed.



Operating procedures, practices, etc., which if not strictly observed will result in damage to equipment if not carefully followed.

NOTE

An operating procedure, condition, etc., which it is considered essential to emphasize.

YOUR RESPONSIBILITY - TO LET US KNOW

Every effort is made to keep the Flight Manual current. However, we cannot correct an error unless we know of its existence. It is essential that you do

your part. Any comments, questions or recommendations should be forwarded, using AF Form 847 through HQ AETC/A3FV, to: 00-ALC/558 ACSG/ENE, 6057 Box Elder Lane, Hill AFB, UT 84056-5811.

SHALL, SHOULD, MAY, AND WILL

The following definitions apply to Shall, Should, May and Will found throughout this manual.

Shall: Used to express a mandatory requirement.

Should: Used to express non-mandatory provisions.

May: Used to express permissiveness.

Will: Used only to indicate future action or result.

ILLUSTRATIONS

The illustrations used throughout the manual are intended to be used as examples.

Unless otherwise specified, references to the HUD applies to both the F-16 HUD and MIL-STD HUD.

SYMBOLS

The references in text and illustrations to the Propulsion Modernization Program (PMP), (T.O. 1T-38-792) have been simplified for ease of reading and are identified by the following notations:

BEFORE PMP
and
AFTER PMP

HUD DISPLAYS

Unless otherwise specified, HUD display applies to MIL-STD and F-16 HUD displays.

TECHNICAL ORDER SUMMARY

FLIGHT MANUAL	BASIC DATE	CHANGE NO. AND DATE
T.O. 1T-38C-1	15 JUN 08	Original
T.O. 1T-38C-1CL-1	15 JUN 08	Original
T.O. 1T-38C-1-1	15 JUN 08	Original
T.O. 1T-38C-1-1CL-1	15 JUN 08	Original

The Technical Order Summary lists only those technical orders which affect this manual and/or checklist.

Technical Order	Title	Disposition
1T-38-792	Installation of Ejector Assembly P/N 1940T50G06, Inlet Duct Assembly P/N 75-11451-503-504, Right and Left Hand F.S. 332.5 P/N 2-11402-9/-10 and F.S. 362.75 P/N 2-11755-19/-20 Bulkheads for the T-38C Aircraft.	Working
1T-38C-546	Escape System Upgrade for T-38C Aircraft	Working
1T-38C-548	T-38C Cockpit Lighting Upgrade	Working
1T-38C-549	Installation of Block 6 software for T-38C Aircraft	Working

STATUS PAGE

SAFETY/OPERATIONAL SUPPLEMENT SUMMARY

The following list contains the previously cancelled or incorporated Safety/Operational Supplements; the outstanding Safety/Operational Supplements, if any; and the Safety/Operational Supplements incorporated in this issue. In addition, space is provided to list those Operational Supplements received since the latest issue. Reference to previously incorporated supplements will be removed at each revision.

NUMBER

PURPOSE

DISPOSITION/
INCORP/DATE

T-38

(BEFORE PMP)

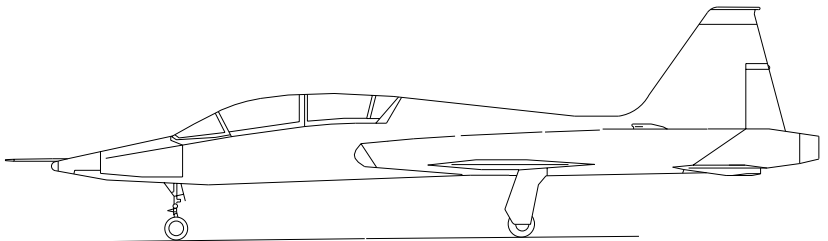
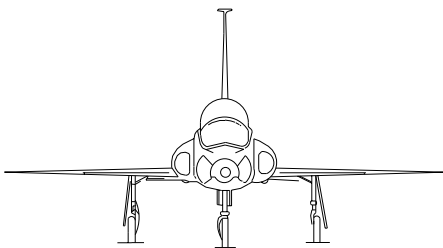
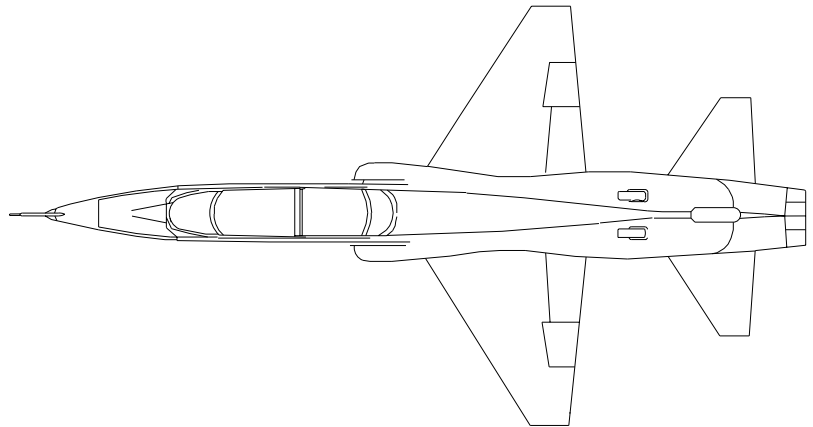
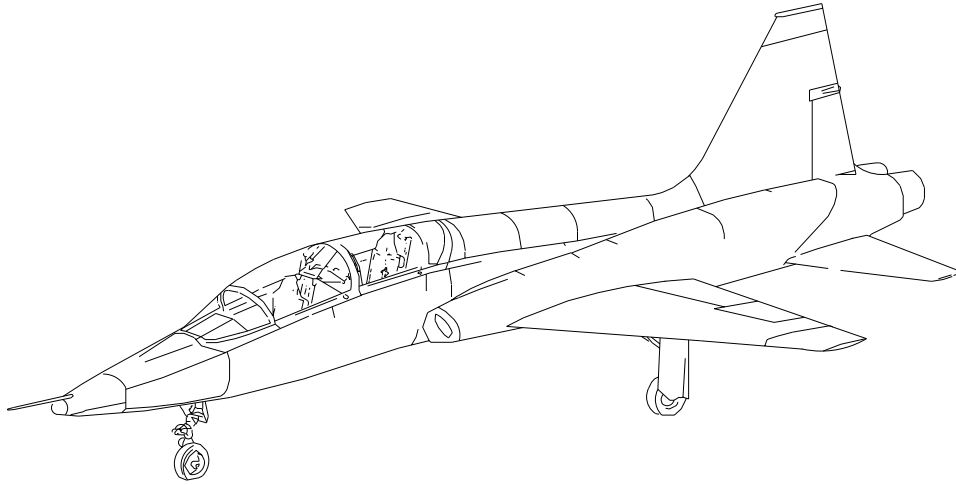

T-38

(AFTER PMP)

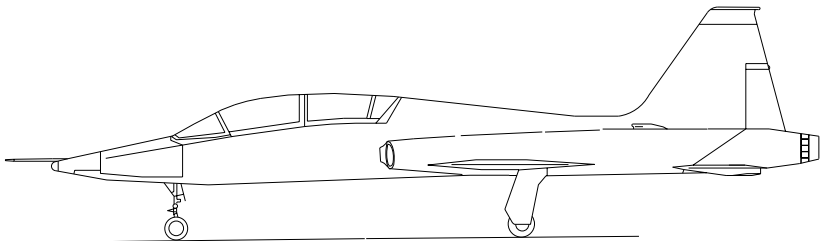
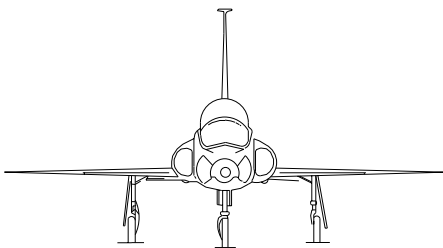
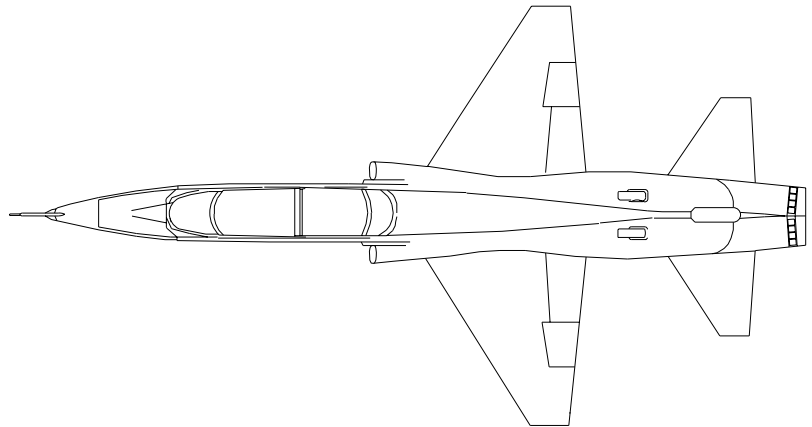
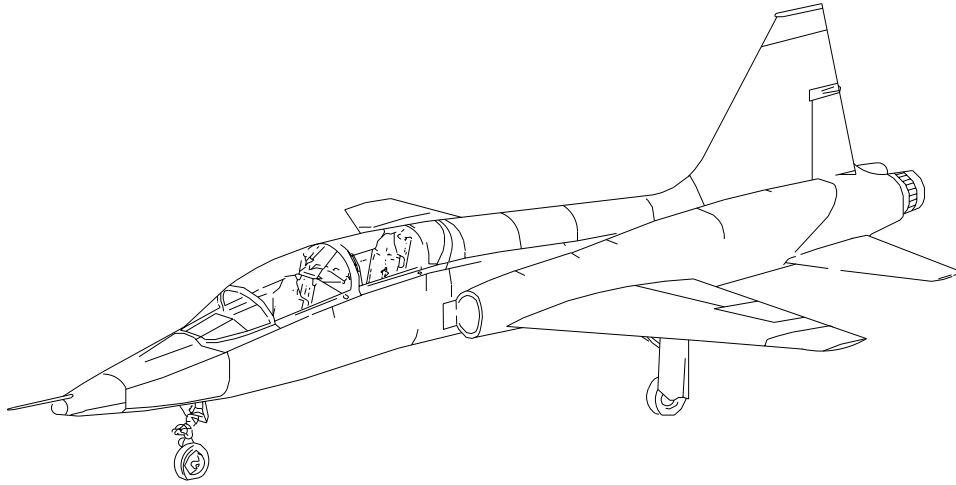

SECTION I

DESCRIPTION AND OPERATION

TABLE OF CONTENTS	Page		Page
AIRCRAFT	1-4	Flap System.....	1-55
ENGINES		Speed Brake System	1-56
Engine Start and Ignition System	1-6	PNEUMATIC SYSTEM	
Throttles	1-7	Pneumatic System Overview	1-57
Electronic Engine Display (EED)	1-8	Cabin Air Conditioning and	
Afterburner System.....	1-29	Pressurization System.....	1-57
Oil System	1-29	Anti-g Suit System	1-58
Airframe Mounted Gearbox	1-29	Engine Anti-Ice System.....	1-58
Fire Warning And Detection System	1-31	PITOT-STATIC SYSTEM	
Engine Compressor Stalls and		Pitot-Static System Overview.....	1-60
Flameouts	1-31	Pitot Boom Anti-Icing	1-60
Engine Compressor Stall/		TAT Probe	1-60
Flameout Susceptibility Area	1-31	ANGLE OF ATTACK (AOA) SYSTEM	
FUEL SYSTEM		AOA System Overview.....	1-61
Fuel System Overview	1-35	AOA Indicator Display	1-61
Fuel Boost Pumps	1-35	AOA Indexer	1-61
Fuel Shutoff Switches.....	1-36	CANOPY	
Fuel Crossfeed.....	1-36	Canopy Operation	1-64
Fuel Displays.....	1-36	Canopy Jettison System	1-65
Fuel Management.....	1-38	EJECTION SYSTEM (BEFORE	
ELECTRICAL SYSTEMS		T.O. 1T-38C-546)	
AC Power System.....	1-39	Ejection Seat	1-68
DC Power System.....	1-39	Ground Egress	1-73
HYDRAULIC SYSTEMS		EJECTION SYSTEM	
Hydraulic Pressure Indicators.....	1-47	(AFTER T.O. 1T-38C-546)	
Hydraulic Caution Lights.....	1-47	Introduction	1-77
LANDING GEAR SYSTEM		Ejection Seat	1-77
Landing Gear Controls	1-49	Ground Egress	1-85
Nosewheel Steering (NWS) System	1-51	OXYGEN SYSTEM	
Wheel Brake System.....	1-51	Oxygen Quantity.....	1-88
FLIGHT CONTROL SYSTEM		AVIONICS SYSTEMS	
Flight Control System Overview	1-52	Avionics Overview	1-90
Control Stick	1-52	Avionics Master Modes	1-90
Rudder System	1-53	Mission Display Processor (MDP).....	1-90
YAW Stability Augmentor System		Air Data Computer (ADC).....	1-91
(YASAS)	1-53	Avionics Activation Panel (AAP).....	1-91
Trim System.....	1-53	Take Command Switch	1-93
LIFT AND DRAG DEVICES		Hands On Throttle and Stick (HOTAS) ..	1-93

T.O. 1T-38C-1

	Page		Page
UP FRONT CONTROL PANEL (UFCP)		Navigation To a Steerpoint	1-293
UFCP Overview	1-99	EGI Navigation Displays.....	1-293
UFCP Controls and Displays	1-99	Nearest Airports	1-297
UFCP Data Entry	1-110	Flight Plan Database Management	1-297
UFCP Function Keys.....	1-118	Flight Plan Navigation	1-298
Hot Keys.....	1-138		
HEAD-UP DISPLAY (HUD)		GROUND BASED NAVIGATION	
HUD System Overview.....	1-139	Ground Based Navigation Overview	1-307
HUD Controls and Displays	1-139	VOR Displays	1-307
HUD Controls.....	1-140	VOR Controls	1-310
F-16 HUD Basic Symbols	1-140	VOR Navigation	1-312
F-16 HUD Gear Down Symbols.....	1-152	ILS Displays.....	1-315
F-16 HUD Declutter	1-154	ILS Controls.....	1-317
MIL-STD HUD Basic Symbols	1-154	ILS Navigation.....	1-320
MIL-STD HUD Gear Down Symbols	1-166	TACAN Displays.....	1-325
MIL-STD HUD Declutter	1-168	TACAN Controls.....	1-327
MULTIFUNCTIONAL DISPLAY (MFD)		TACAN Navigation.....	1-330
MFD Overview.....	1-169	Air-To-Air TACAN (AAT)	1-333
MFD Controls.....	1-169	Navigation Tuning	1-335
MFD Displays.....	1-171		
Basic Flight Instruments.....	1-176	BACKUP CONTROL PANELS	
Flight Data Blocks	1-185	Backup Control Panels Overview.....	1-337
MFD NAV and COMM Data	1-188		
Primary Flight Reference (PFR)	1-192	PREPROGRAMMED APPROACHES (PPA)	
PFR Option Select Buttons (OSB)		PPA Overview.....	1-341
Labels and Functions.....	1-194	PPA Data.....	1-341
Horizontal Situation Display (HSD)	1-198	Self Contained Approach (SCA)	1-342
HSD MFD Option Select Buttons		PPA VOR/ILS/DME Approaches.....	1-344
(MOSB) Labels and Functions.....	1-204		
MFD Menu and Function Display Pages.	1-206	COMMUNICATION EQUIPMENT	
MFD Backup Display	1-231	Communication System Overview	1-347
EMBEDDED GLOBAL POSITIONING SYS-		Audio Control Panel (ACP).....	1-347
TEM (GPS)/INERTIAL NAVIGATION SYS-		Miscellaneous Communication	
TEM (INS) EGI		Equipment Controls	1-349
EGI System Overview.....	1-236	UHF/VHF Controls and Displays,	
EGI Operation	1-239	UFCP	1-350
EGI Operations with MDP Failure	1-263	Communication Backup Mode	
NAVIGATION OVERVIEW		Operations	1-350
Navigation Controls	1-272		
Navigation Displays	1-272	IDENTIFICATION FRIEND OR FOE (IFF)/	
EGI Navigation Definitions	1-272	TRAFFIC COLLISION AVOIDANCE SYSTEM	
Navigation Source	1-274	(TCAS)	
Navigation Controls and Displays	1-277	IFF System Overview.....	1-351
Flight Director Logic and Usage	1-280	TCAS System Overview	1-351
GPS/INS BASED NAVIGATION		IFF/TCAS Controls.....	1-352
Destination Database Management.....	1-284	UFCP IFF/TCAS Controls	
		And Displays	1-352
		IFF/TCAS Modes.....	1-352
		MFD TCAS Controls and Displays	1-353
		HUD TCAS Displays.....	1-356
		TCAS Aural Alerts.....	1-358
		TCAS Limitations	1-359

	Page		Page
DATA TRANSFER SYSTEM (DTS)		WARNING/CAUTION/ADVISORY (WCA)	
DTS Overview	1-363	SYSTEM	
DTS Controls and Displays	1-363	Warning/Caution/Advisory (WCA)	
Inflight and Post Flight Data Transfer		Indicators.....	1-380
From MDP To DTC	1-365	Warning/Caution/Advisory (WCAs)	
Initiation and Termination Of Data		Lights Controls	1-381
Recording.....	1-366	WCAs Displayed on HUD and MFD	1-381
VIDEO TAPE RECORDER (VTR)		WCA Tones	1-382
VTR System Overview	1-371	WCA Visual and Aural Tone Priorities	1-382
VTR Controls and Displays.....	1-371	Warnings.....	1-383
STANDBY INSTRUMENTS		Cautions	1-384
Standby Attitude Indicator	1-375	Advisories	1-388
Standby Airspeed Indicator.....	1-376	Malfunction Monitoring.....	1-388
Standby Altimeter	1-376	SYSTEM MONITORING AND TEST	
Standby Vertical Velocity Indicator		Test Display Page	1-391
(VVI)	1-377	EED Test and IBIT	1-394
Standby Compass	1-377	MISCELLANEOUS EQUIPMENT	
LIGHTING EQUIPMENT		Additional Equipment	1-396
Interior Lighting	1-378	Servicing Diagram	1-396
Exterior Lighting.....	1-378		

AIRCRAFT

The T-38C aircraft (Figure 1-1), originally produced by Northrop Corporation, Aircraft Division and upgraded by The Boeing Company, is a two-place, twin-turbojet supersonic trainer. Each cockpit contains an individual jettisonable canopy and ejection seat. A cabin air conditioning and pressurization system conditions and pressurizes the air in both cockpits. The fuselage is an area-rule (coke bottle) shape, with moderately swept-back wings and empennage. The aircraft is equipped with an all-movable horizontal tail. A speed brake is located on the lower surface of the fuselage center section. The tricycle landing gear has a steerable nosewheel. All flight control surfaces are fully powered by two independent hydraulic systems.

The aircraft has a 24° total field-of-view Head Up Display (HUD) displaying symbolic flight and weapon delivery information and a Multifunctional Display (MFD) that replaces traditional flight instruments. System interface and control are provided by an Up Front Control Panel (UFCP) and Hands On Throttle And Stick (HOTAS) system.

The overall dimensions of the aircraft with normal tire and strut inflation are:

Length.....	46 ft 4in.
Wingspan.....	25 ft 3in.
Height.....	12 ft 11 in.
Tread	10 ft 9 in.
Wheelbase	19 ft 5 in.

The gross weight of the aircraft fully serviced with two aircrew is approximately 12,800 pounds. Aircrew should use actual weights for computing aircraft performance.

NOTE

Cockpit controls not referenced to a specific figure can be viewed in the FOLDOUT ILLUSTRATIONS section (FP-1).

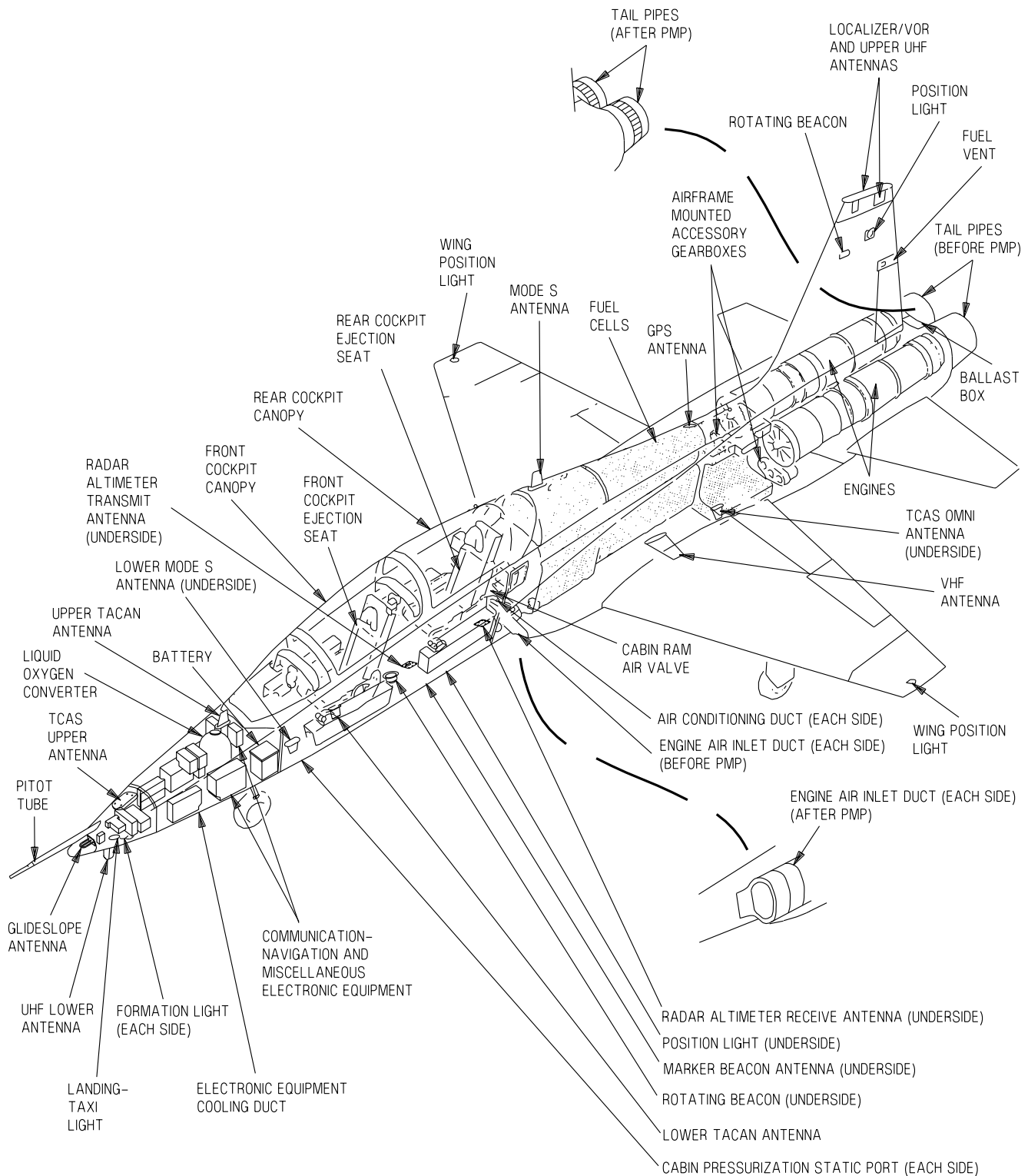

Figure 1-1. General Arrangement

T38002-44-1-020

ENGINES

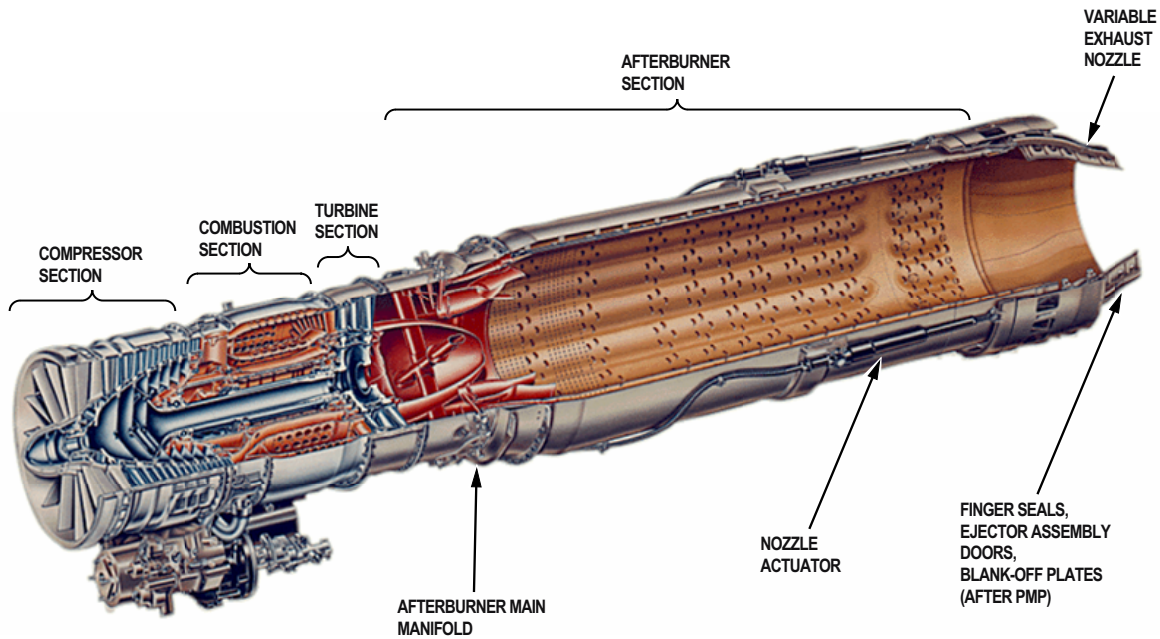

Figure 1-2. J85-GE- 5R ENGINE

T38002-617-1-020

(BEFORE PMP) The aircraft is powered by two J85-GE-5, eight-stage, axial-flow, turbojet engines. Sea Level, standard day, static thrust for an installed engine is approximately 2050 pounds at military (MIL) power and approximately 2900 pounds at full maximum (MAX) power.

(AFTER PMP) The aircraft is powered by two J85-GE-5R, eight-stage, axial-flow, turbojet engines (Figure 1-2). Sea level, standard day, static thrust for an installed engine is approximately 2200 pounds at military (MIL) power and approximately 3300 pounds at full maximum (MAX) power.

Air enters through the variable inlet guide vanes, which direct the flow of air into the compressor. The automatic positioning of the inlet guide vanes and air bleed valves assists in regulating compressor airflow to maintain stall-free compressor operation. Two turbine wheels and the compressor rotor stages are mounted on the same shaft. The exhaust gases are discharged through a variable area exhaust nozzle. An exhaust gas temperature (T_5) sensing system varies the nozzle area to maintain Exhaust Gas Temperature (EGT) within limits at both MIL and MAX range throttle positions.

ENGINE START AND IGNITION SYSTEM

Engine starts require compressor motoring (low pressure air supply), Direct Current (DC) power to energize the ignition holding relay and Alternating Current (AC) power for ignitor firing. For ground starts, a manually operated diverter valve, mounted on the left engine, is positioned by the ground crew to direct the flow of air to the selected engine during the start cycle. Two ENGINE START Buttons are located in the left sub-panel of each cockpit, Figure 1-3. Momentarily pushing the ENGINE START Button for the selected engine arms the ignition circuit (ignition timer and holding relay) for approximately 30 seconds. Moving the throttle to IDLE energizes the ignition exciter, firing main and afterburner igniters and allows starting fuel flow to the engine. Any delay

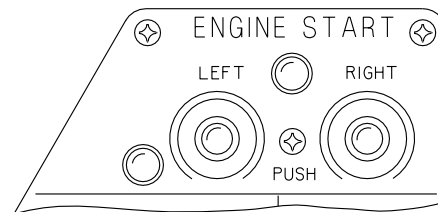
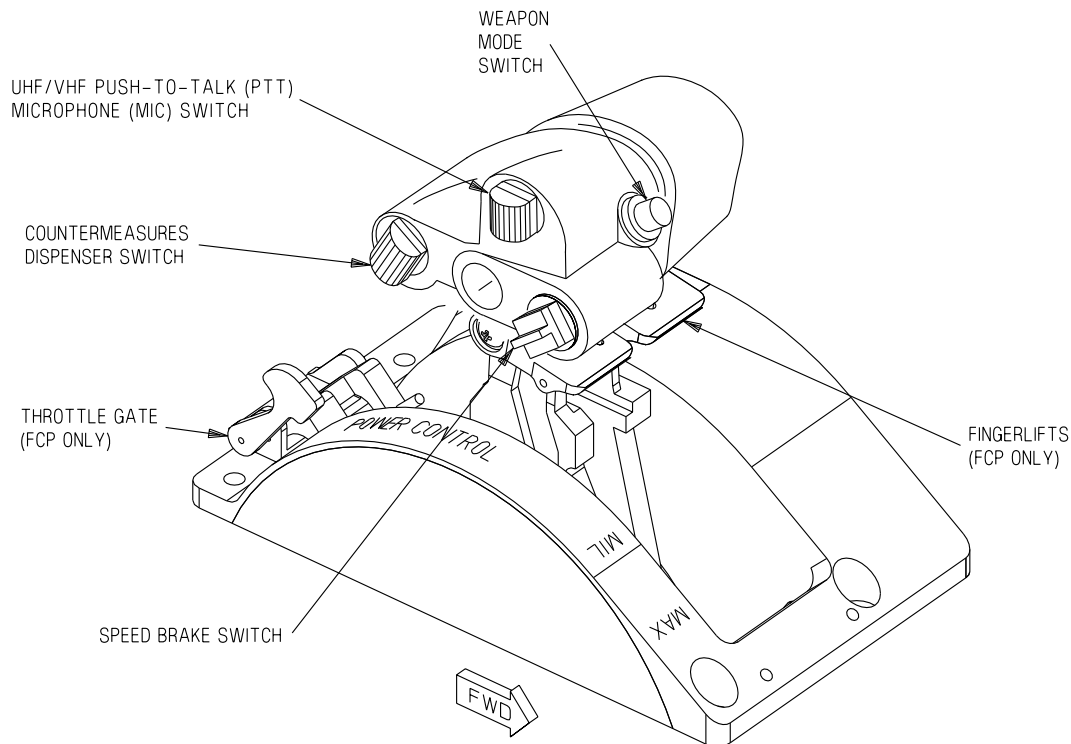

Figure 1-3. Engine Start Buttons

T38002-216-1-020



T38002-217-1-020

Figure 1-4. Throttles

in moving the throttle to IDLE after pushing the ENGINE START Button decreases the available ignition time from the 30 second cycle by an equal amount.

Momentarily pressing the ENGINE START Button again during a 30-second cycle does not reset the ignition timer and start another cycle since the first actuation locks in the cycle (holding relay energized) until the timer expires.

Without any ENGINE START Button ignition cycle operating, moving the throttle to the MAX range energizes the main and afterburner igniters for a 30 second cycle. Subsequently retarding the throttle out of MAX range at any time during the 30-second cycle stops the igniters from firing, resets the time (bypassing the ignition holding relay) and enables the ignition system for a new cycle. The throttle must be retarded from MAX to below MIL to reset the timer and returned to MAX to provide another 30-second cycle. However, pressing the ENGINE START Button within 30 seconds before or after selecting MAX only provides ignition for the duration of the first 30-second ignition cycle selected and disables the

MAX ignition reset feature until the first selected (ENGINE START Button or MAX) 30 second ignition cycle has expired.

With the throttle at IDLE or above, the igniters can be energized at anytime for longer than 30 seconds by selecting and holding the appropriate ENGINE START Button.

AC power from a battery operated static inverter can be used for engine starts. For battery start, the static inverter supplies AC power to circuits that provide the right fuel flow, and oil pressure indications during the start cycle. Refer to ELECTRONIC ENGINE DISPLAY, this section.

THROTTLES

The throttles (Figure 1-4) are provided with a roller ramp-type force gradient, which must be overcome to move the throttles from MIL into MAX range or from IDLE to OFF. The throttles in the front cockpit (FCP) are equipped with fingerlifts which must be raised before the throttles in either cockpit can be retarded past the IDLE roller ramp to OFF. Friction

T.O. 1T-38C-1 ENGINES

is ground adjustable only. The throttles, when placed at OFF, mechanically shut off fuel to the engine at the main fuel control and electrically shut off fuel to the engine fuel shutoff valves.

A throttle gate is installed on the FCP throttle quadrant. When engaged, the throttle gate prevents the throttles being moved to the OFF position. Rotating the throttle gate full forward and down locks it in the engaged position. The throttle gate is disengaged by pressing the lever inward. Spring tension automatically rotates the throttle gate aft and open. With the throttle gate disengaged, the throttles can be moved to the OFF position.

WARNING

Avoid fingerlift actuation to preclude inadvertent engine shutdown when retarding throttle toward idle.

NOTE

Throttle movement should be conservative to help minimize blade failures. Abrupt or rapid throttle movements should be avoided. Throttle bursts (throttle movement in 1 second or less) from idle Revolutions Per Minute (RPM) to MIL should be avoided if possible. These procedures allow the variable exhaust nozzle to keep pace and match the fuel flow and help to minimize the possibility of compressor blade failures.

ELECTRONIC ENGINE DISPLAY (EED)

EED OVERVIEW

Engine instruments and fuel system indications appear primarily on the EED, see Figure 1-5.

The EED is installed on the right side of the main instrument panel in both cockpits. The EED is a processing and display unit containing analog interfaces to the engine sensors (RPM, EGT, Oil Pressure, Nozzle Position), fuel flow, and fuel quantity gauging systems. These analog inputs are connected in parallel to both the front and rear cockpit EEDs which operate in a Master/Slave relationship. This provides

a completely redundant display of engine information. The analog inputs are processed by the Master EED which then generates graphics for display on the 6.4 inch diagonal color Liquid Crystal Display (LCD) screen. The Master EED also transmits the digital engine and fuel system data to the Slave EED and the MDP via a SERIAL BUS.

The MDP also processes the Master EED transmitted data for display on either cockpit MFD EED Display Page when selected by the aircrew. In the event of a failure or loss of the EED Display in either cockpit, this selectable, secondary (redundant) EED Display is accessible via the MENU Display Page as long as the MDP is operational and at least one of the aircraft EEDs is operational. Refer to MFD MENU AND FUNCTION DISPLAY PAGES in this section.

NOTE

- For engine and fuel data to display on the MFD EED Display Page, at least one EED must be on and operating.
- The EED chronometer and the Master (M) or Slave (S) indication is not displayed on the MFD EED Display Page.

The EED normally operates on right essential DC power. If both aircraft AC power systems are not operational (failed/turned off), or if external power is not available, the EED is powered by the aircraft battery (battery switch ON and operational).

For proper display on the EED, the Oil Pressure, Fuel Flow, and Fuel Quantity sensors require AC power. When operating from the aircraft battery, only left and right RPM, EGT, and nozzle indications are valid. The left and right oil pressure, fuel flow, and fuel quantity indicators displays OFF, see Figure 1-21, sheet 1. Pressing and holding the OXY/FUEL test switch in either the GAGE TEST or QTY CHECK position engages the static inverter to power the right engine fuel flow, right oil pressure, and the left, right and total fuel quantity indicators as long as the switch is held in either position.

During engine starts using battery power, if battery voltage is less than 22 VDC, the EED Display powers up at maximum Day Mode brightness regardless of O/N/D switch position. When the first generator

comes on line, EED brightness reverts to the maximum brightness level of the O/N/D switch position. At this point the EED Display brightness level responds to the commanded brightness setting.

EED MODES OF OPERATION

The EED has two primary modes of operation, Master or Slave, indicated by a green M or S displayed on the upper right corner of the EED Display screen. The FCP and RCP EEDs work together in Master/Slave relationship. The Master EED reads the analog engine and fuel system data from the aircraft sensors (RPM, EGT, etc.) and displays the data on the Master EED. The Slave EED uses the Master EED digital engine and fuel system data to create a redundant display. With both FCP and RCP EEDs on and

operating, the FCP EED normally operates as the Master and the RCP EED operates as the Slave.

The Master/Slave relationship between the FCP and RCP EED can be changed manually or automatically as follows:

- a. Manually press and release the EED Master/Slave (M) button on either the Master EED or Slave EED.
- b. The Slave EED internally senses it is not receiving the digital engine and fuel system data from the Master EED and changes Master/Slave modes automatically. Depending on the failure mode (processing or display), the new Slave EED either blanks or displays corresponding failure indications.



Figure 1-5. Electronic Engine Display (EED)

NOTE

Erroneous or fluctuating engine sensor data displayed on the Master EED should be confirmed with the other cockpit by switching the EED Master/Slave relationship mode.

During normal EED Master/Slave transitions, the digital readout of each engine sensor displayed on both of the EEDs can be removed and INIT displayed until the new Master EED is capable of displaying valid data. In the event the new Master EED is unable to display valid engine sensor data, the INIT is replaced by an OFF or FAIL in one or more of the engine indicators on the EED Display (depending upon the failure mode). Refer to EED ENGINE and FUEL DISPLAYS, in this section, for further information.

EED CONTROLS

There are five controls located on the right side of the EED bezel, see Figure 1-5. The EED buttons and switches are backlit and the brightness is controlled by the aircraft INSTRUMENT control rheostat. Refer to INTERIOR LIGHTING in this section for further information.

Off/Night/Day (O/N/D) Power Knob

The EED is powered ON and OFF via the O/N/D Power Knob. At least one of the EED Power Knobs must be in either the N or D position to enable display of the EED on either MFD.

NOTE

When either EED is powered ON or OFF, the EED momentarily activates the aircraft FUEL LOW caution light.

With ambient temperatures above 32° F, the EED comes on within 15 seconds. If the ambient temperature is below 32° F, it may take up to 5 minutes for the EED to come on. The EED Display brightness may initially be dim during cold weather start-up.

When the EED is powered up in Day Mode (D), the EED Display brightness intensity defaults to maximum Day Mode brightness. If Night Mode (N) is then selected and the existing EED Display brightness is greater than the maximum night brightness, the EED Display brightness resets to the maximum night brightness level of illumination. If the adjustable Day

Mode brightness setting is within night illumination parameters, the EED Display brightness remains at the current setting. Night Mode brightness intensity is adjusted via the EED Display Brightness Control Rocker Switch.

When the EED is powered up in the Night Mode (N), the EED Display brightness intensity defaults to the maximum Night Mode brightness. EED maximum display brightness in Night Mode is approximately 10 % of the maximum Day Mode brightness intensity. If the Power Knob D position is then selected, the display brightness remains at the existing night setting. Day Mode brightness intensity can then be adjusted by using the EED Display Brightness (B) Control Rocker Switch.

Display Brightness (B) Control Rocker Switch

The EED Display brightness intensity in either Night or Day Mode can be adjusted via the EED Display Brightness (B) Control Rocker Switch. Pressing the top side (^) of the switch increases brightness while pressing the bottom side (v) of the switch decreases the brightness as follows:

- a. A momentary press on the top or bottom of the switch (< 0.4 second) changes the brightness of all symbols by a single increment.
- b. Pressing and holding (> 0.4 second) the top or bottom of the switch provides a linear brightness intensity adjustment enabling transition from minimum to maximum or maximum to minimum in approximately 5 seconds.

Display Test (T) Button

Pressing and holding the EED Display Test (T) Button performs the following functions:

- a. Initiated Built In Test (IBIT) accessed if the button is held for > 2 seconds and released within 15 seconds.
- b. Accesses the EED calibration display if held for more than 15 seconds while WOW. The calibration display enables maintenance personnel to calibrate EED parameters. The calibration page is exited when any of the following occur:
 - (1) The EED Chronometer (C) Control Button is pressed (EXIT).
 - (2) Selection of weight off wheels on the WOW Switch in the RCP.
 - (3) At weight off wheels during takeoff.

T.O. 1T-38C-1 ENGINES

- (4) When the other cockpit EED switches to the master mode (EEDs must be ON in both cockpits).
- (5) When the respective EED is turned off.

NOTE

With WOW, pressing the T button for longer than 15 seconds selects the calibration page. The calibration page is intended for maintenance functions only and should not be selected by the aircrew.

Refer to SYSTEMS MONITORING AND TEST, this section, for more information on EED IBIT.

Chronometer (C) Control Button

In the normal operating mode, pressing the C button displays the chronometer in MM:SS as follows:

- a. First press displays chronometer run time which begins at 00:00.
- b. Second press stops the chronometer.
- c. Third press removes the chronometer from the display.

When the chronometer display reaches 59:59, the display resets to 00:00 and continues.

Master/Slave (M) Button

In the normal operating mode, this button toggles the EED mode from Master to Slave and back (both EEDs must be on).

EED ENGINE AND FUEL INDICATORS

The EED includes the following engine and fuel indicators:

- a. Engine Tachometer (RPM).
- b. Exhaust Gas Temperature (EGT).
- c. Nozzle Position (NOZ).
- d. Oil Pressure (OIL).
- e. Fuel Flow (FF).
- f. Fuel Quantity.
- g. Total Fuel Quantity.

At EED powerup, on both the Master and Slave EED, Initialization (INIT) is displayed in the digital readout area of each engine/fuel sensor indicator and the analog pointers/vertical scales are set to zero until the

Master EED is completely initialized and capable of displaying valid engine sensor/fuel data, Figure 1-21, sheet 1. This INIT period is typically less than 8 seconds for engine sensor (RPM, EGT, Oil Pressure, Nozzle Position, and Fuel Flow) and 10 seconds for Fuel Quantity. After the initialization period, one of the following events will occur:

- a. The INIT display is replaced with a zero or actual value for the specific indicator, Figure 1-21, sheet 1. The analog pointers/vertical scales match the digital readouts. The Slave EED and MFD EED Display Page repeat the valid data.

- b. The INIT display is replaced with a zero (RPM, EGT) or OFF (NOZ, OIL, FF, Fuel Quantity) when there is no source data from an external sensor detected by the Master EED, Figure 1-21, sheet 2. The analog pointers/vertical scales are removed from the EED Display when OFF is displayed. For fuel quantity, if the CROSSFEED switch is on, and one tank shows OFF, the CROSSFEED indicator on the EED Display is drawn horizontally from the tank that has valid data and the Fuel Imbalance indication is removed. If both left and right tank indications are OFF, the CROSSFEED indication and Fuel Imbalance indication is not displayed. The Slave EED and MFD EED Display Page repeat the OFF indications.

- c. The INIT Display is replaced with FAIL in the affected indicator if there is an internal EED failure. The analog pointers/vertical scales are removed and EED FAIL is displayed in the EED message window, Figure 1-21, sheet 3. For fuel quantity, if the CROSSFEED switch is on, and one tank shows OFF, the CROSSFEED indicator on the EED Display is drawn horizontally from the tank that has valid data and the Fuel Imbalance indication is removed. If both left and right tank indications are OFF, the CROSSFEED indication and Fuel Imbalance indication is not displayed. The Slave EED and MFD EED Display Page repeat the OFF indications but not the EED FAIL in the EED message window.

NOTE

The Slave EED should be switched to the Master by pressing the M button on either cockpit EED whenever an OFF or a FAIL is displayed on the Master EED.

Preceding zeros are not displayed on any of the EED digital readouts for all EED engine and fuel indicators.



T38002-394-1-020

Figure 1-6. Normal RPM Indicator



T38002-394-2-020

Figure 1-7. RPM Exceedance Caution

ENGINE INDICATORS

Tachometer (RPM)

The Master EED receives AC voltage from the tachometer transmitter for each engine and uses the frequency to interpret and display the engine RPM, see Figure 1-6. The analog pointer displays engine speed as a percent of maximum RPM from 0-110% labeled in 10% increments. The tic marks adjacent to the numerals are white except for the tic marks adjacent to 5 and 10 which are green. The digital readout displays three digits from 0-110% in 1% intervals. Different sections of the perimeter are colored as follows:

- Light green arc from 46-50% (only when WOW).
- Dark green arc from 99-101%.
- Dark green arc from 101-104% (only when weight off wheels).
- One longer red tick mark at 107%.

The title and pointer are white during normal engine operation.

If the engine RPM exceeds the engine overspeed limits, the pointer and RPM title on the RPM indicator turns red, see Figure 1-7. The pointer returns to white when the RPM is below the overspeed limit. An ENGINE caution is also displayed on the HUD and MFD message windows, see WARNING/CAUTION/ADVISORY (WCA) SYSTEM, this section. The RPM title latches red, see Figure 1-8, and must be

manually reset by maintenance personnel. The Slave EED and MFD EED Display Page mimic this behavior.

If an internal failure is detected by the Master EED which prevents the accurate display of RPM, the analog pointer and digital readout are blanked, EED FAIL is displayed in the Master EED message window, and FAIL is displayed in the center of the failed indicator in the Master, Slave and MFD EED. If the M button is pressed, the malfunctioning EED retains the EED FAIL message and accurate RPM is displayed in the Master, Slave and MFD EED. Refer to Figure 1-21, sheet 4.

If the Master EED is unable to detect the RPM sensor signal or senses 0% RPM, the analog pointer and digital readout display 0% RPM until a valid sensor signal is detected, Figure 1-21, sheet 4. The Slave EED and MFD EED Display Page mimic this behavior.

When the Master EED is made the Slave, the RPM digital readout is blanked and INIT displayed in place of the digital readout until the new Master EED displays valid data, Figure 1-21, sheet 4. The analog pointer displays the last calculated value prior to the Master to Slave transition while INIT is displayed. If the Master EED remains in INIT mode for more than 8 seconds after the transition, INIT is replaced by 0% RPM if the Master EED is unable to detect the RPM sensor signal or senses 0% RPM. INIT is replaced by FAIL if an internal EED indicator failure occurs. INIT is not displayed during Slave to Master transitions.

T.O. 1T-38C-1 ENGINES



T38002-394-3-020

Figure 1-8. Latched RPM Exceedance

Exhaust Gas Temperature (EGT)

The Master EED receives a DC voltage produced by the exhaust gas temperature thermocouples to interpret and display the engine EGT.

The pointer displays EGT 0 - 1200°C on a round dial analog scale with white tic marks and numbers spaced around the indicator, see NORMAL EGT INDICATOR Figure 1-9. The analog pointer, digital readout, and EGT title are normally colored white. The digital display is up to four digits from 0 to 1200°C in 5° increments. The display is colored as follows:

- Long white tic mark at 0 and 140°C.
- Dark green arc 630 - 645°C.
- Long red tic marks at 845 and 925°C.

NOTE

Actual EGT limits are 630 - 650°C for MIL/MAX power. Refer to Section V.

During an EGT exceedance, the needle, digital readout, and EGT title on both EEDs and MFD EED Display Page remain white.

The EED declares an overtemperature once the time versus temperature threshold of the biased EGT curve has been met. Under this condition, the EGT arrow, digital readout, and EGT title on the EGT indicator turns red. Refer to EGT OVERTEMP CAUTION, Figure 1-9. An ENGINE caution is also displayed in the HUD and MFD message windows. An EGT OVERTEMP PFL is also displayed. Refer to

WARNING/CAUTION/ADVISORY (WCA) SYSTEM, section I and/or III. The EGT title remains latched red but the arrow and digital readout return to white when the EGT goes below the biased EGT curve. Refer to LATCHED EGT OVERTEMP, Figure 1-9. The latched EGT title must be manually reset by maintenance personnel. The Slave EED and MFD EED Display Page mimic this behavior.

If an internal failure is detected by the Master EED which prevents the accurate display of EGT, the analog pointer and digital readout are blanked, EED FAIL is displayed in the Master EED message window, and FAIL is displayed in the center of the failed indicator in the Master, Slave and MFD EED. If the M button is pressed, the malfunctioning EED retains the EED FAIL message and accurate EGT is displayed in the Master, Slave and MFD EED. Refer to Figure 1-21, sheet 4.

If the Master EED is unable to detect the EGT sensor signal or senses 0°C EGT, the analog pointer and digital readout display 0°C until a valid sensor signal is detected, Figure 1-21, sheet 4. The Slave EED and MFD EED Display Page mimic this behavior.

When the Master EED is made the Slave, the EGT digital readout is blanked with INIT displayed in place of the digital readout until the new Master EED Displays valid data, Figure 1-21, sheet 4. The analog pointer displays the last calculated value prior to the Master to Slave transition while INIT is displayed. If the Master EED remains in INIT mode for more than 8 seconds after the transition, INIT is replaced by 0°C EGT if the Master EED is unable to detect the EGT sensor signal or senses 0°C EGT. INIT is replaced by FAIL if an internal EED indicator failure occurs. INIT is not displayed during Slave to Master transitions.

Nozzle Position (NOZ)

The Master EED receives three DC voltages produced by the nozzle position transmitter to interpret and display engine nozzle position.

The pointer displays exhaust nozzle position as a percent of maximum open nozzle position from 0-99% labeled in 20% increments on a round analog scale. Tic marks are equally spaced at 10% increments. The digital readout is from 0-99% in 1% increments. The tic marks, pointer, digital readout, and NOZ title are always white, see Figure 1-10.



NORMAL EGT INDICATOR



EGT OVERTEMP CAUTION



LATCHED EGT OVERTEMP

Figure 1-9. EGT Indicator

T38002-393-1-021

If an internal failure is detected by the Master EED which prevents the accurate display of NOZ, the analog pointer and digital readout are blanked, EED FAIL is displayed in the Master EED message window, and FAIL is displayed in the center of the failed indicator in the Master, Slave and MFD EED. If the M button is pressed, the malfunctioning EED retains the EED FAIL message and accurate NOZ is displayed in the Master, Slave and MFD EED. Refer to Figure 1-21, sheet 5.

If the Master EED is unable to detect the nozzle position sensor signals, the analog pointer and digital readout are blanked and OFF is displayed in the center of the indicator until a valid sensor signal is detected, Figure 1-21, sheet 5. The Slave EED and MFD EED Display Page mimic this behavior.



T38002-396-1-020

**Figure 1-10. Normal Nozzle Position Indicator
Oil Pressure (OIL)**

When the Master EED is made the Slave, the nozzle position digital readout is blanked with INIT displayed in place of the digital readout until the new Master EED displays valid data, Figure 1-21, sheet 5. The analog pointer displays the last calculated value prior to the Master to Slave transition while INIT is displayed. If the Master EED remains in INIT mode for more than 8 seconds after the transition, INIT is replaced by OFF and the analog pointer is removed if the Master EED is unable to detect NOZ sensor signal. INIT is replaced by FAIL if an internal EED indicator failure occurs. INIT is not displayed during Slave to Master transitions.

The Master EED receives three AC voltages in a synchro format from the oil pressure transmitter to interpret and display engine oil pressure, see Figure 1-11.

**T.O. 1T-38C-1
ENGINES**

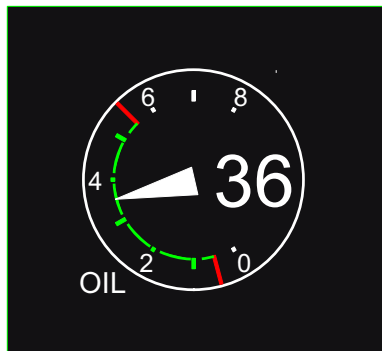

T38002-395-1-020

Figure 1-11. Normal Oil Pressure Indicator

The pointer displays engine oil pressure from 0-80

Pounds per Square Inch (PSI) on a round analog scale. Tic marks are equally spaced at 10 PSI increments and white numeric dial indicators at 20 PSI increments. The white digital readout displays up to two digits in 1 PSI increments. The analog pointer and OIL title are normally white. Different sections of the dial have unique colors as follows:

- a. A light green tic mark at 10 PSI.
- b. Dark green tic marks at 20, 30, 40, and 50 PSI.
- c. Long red tic marks at 5 and 55 PSI.
- d. A light green arc from 5 - 19 PSI.
- e. Dark green arcs from 20 - 55 PSI.

The table below (Figure 1-12) summarizes oil pressure caution and latch display conditions.

CONDITION					INDICATION		STATUS
OIL PRESSURE	WEIGHT ON/OFF WHEELS	FUEL FLOW	RPM	DURATION	NEEDLE	OIL PRESSURE TITLE	
< 5 PSI	ON	> 200 PPH	≥ 46%	0 SEC	RED	WHITE	CAUTION
< 5 PSI	OFF	> 100 PPH	N/A	10 SEC	RED	WHITE	CAUTION
< 5 PSI	OFF	> 100 PPH	N/A	30 SEC	RED	RED	LATCH
≥ 56 PSI	ON	> 200 PPH	≥ 46%	0 SEC	RED	WHITE	CAUTION
≥ 56 PSI	ON	> 200 PPH	≥ 46%	6 MIN	RED	RED	LATCH
≥ 56 PSI	OFF	> 100 PPH	N/A	0 SEC	RED	RED	LATCH

Figure 1-12. Oil Pressure Caution/Latch Display Conditions

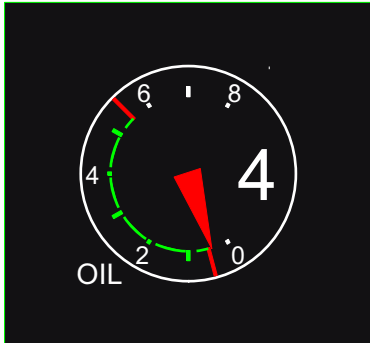

T38002-395-2-020

Figure 1-13. Low Oil Pressure Caution

The EED oil pressure analog pointer, Figure 1-13, turns red and the title remains white under the following conditions:

- a. < 5 PSI instantaneously with WOW.
- b. < 5 PSI for 10 seconds continuously with weight off wheels.
- c. \geq 56 PSI instantaneously with WOW.

An ENGINE caution is also displayed in the HUD and both MFD message windows. Refer to WARNING/CAUTION/ADVISORY (WCA) SYSTEM, this section.

The oil pressure analog pointer reverts to white when the associated system pressure returns within the normal operating range.

The EED oil pressure analog pointer and OIL title turns red, (Figure 1-14) under the following conditions:

- a. < 5 PSI for 30 seconds continuously with weight off wheels.
- b. \geq 56 PSI for 6 minutes continuously with WOW.
- c. \geq 56 PSI instantaneously with weight off wheels.



T38002-395-3-020

Figure 1-14. High Oil Pressure Latch

An ENGINE caution is also displayed in the HUD and both MFD message windows. An OIL PRESSURE LOW or OIL PRESSURE HIGH PFL is also issued. Refer to WARNING/CAUTION/ADVISORY (WCA) SYSTEM, section I and/or III.

The oil pressure analog pointer reverts to white when the associated system pressure returns within the normal operating range, however the OIL title remains latched red and can only be manually reset by maintenance personnel.

If an internal failure is detected by the Master EED which prevents the accurate display of OIL, the analog pointer and digital readout are blanked, EED FAIL is displayed in the Master EED message window, and FAIL is displayed in the center of the failed indicator in the Master, Slave and MFD EED. If the M button is pressed, the malfunctioning EED retains the EED FAIL message and accurate OIL is displayed in the Master, Slave and MFD EED. Refer to Figure 1-21, sheet 5.

If the Master EED is unable to detect the oil pressure sensor signals, the analog pointer and digital readout are blanked and OFF is displayed in the center of the respective indicator until valid sensor signals are detected, Figure 1-21, sheet 5. The Slave EED and MFD EED Display Page mimic this behavior.

T.O. 1T-38C-1 ENGINES

When the Master EED is made the Slave, the oil pressure digital readout is blanked and INIT displayed in place of the digital readout until the new Master EED displays valid data, Figure 1-21, sheet 5. The analog pointer displays the last calculated value prior to the Master to Slave transition while INIT is displayed. If the Master EED remains in INIT mode for more than 8 seconds after the transition, INIT is replaced by OFF and the analog pointer is removed if the Master EED is unable to detect OIL sensor signal. INIT is replaced by FAIL if an internal EED indicator failure occurs. INIT is not displayed during Slave to Master transitions.

FUEL INDICATORS

Fuel Flow (FF)

The Master EED receives three AC voltages in a synchro format from the Fuel Flow transmitter to interpret and display Fuel Flow. Additionally, for both the left and right fuel flow indicators to operate normally, the fuel flow power supply requires DC power from the left essential DC bus. If this power is absent, both the left and right fuel flow indicators will display zero.

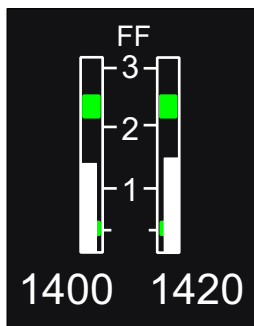

T38002-400-1-020

Figure 1-15. Normal Fuel Flow Indicator

The FF indicator consists of two vertical analog scales with respective white solid bar indicators that indicate fuel flow in Pounds Per Hour (PPH). The digital readout located at the bottom of each indicator is colored white and displays up to four digits in 20 PPH

increments, see Figure 1-15. There are white tic marks labeled and spaced at every 1000 PPH with additional markings as follows:

- Short white tic marks at 360 PPH.
- Light green bars between 400 - 600 PPH.
- Dark green bars between 2100 - 2500 PPH.

NOTE

- PMP aircraft FF limits in MIL power are 2100 - 2700 PPH. Refer to Section V.
- The increased fuel flow during after-burner operation is not provided to, or displayed by, the EED.
- Before engine start, with external or battery power applied, the EED fuel flow indicator(s) should read no higher than 60 PPH. A higher indication may be an indication of EED failure or a fuel transmitter failure.
- During an engine shutdown, if the operating generator accepts the electrical load from the inoperative engine, the EED fuel flow indicator(s) on the inoperative engine should read no higher than 60 PPH.

If an internal failure is detected by the Master EED which prevents the accurate display of FF, the solid white bar is blanked, EED FAIL is displayed in the Master EED message window, and FAIL is displayed in place of the digital readout of the failed indicator in the Master, Slave and MFD EED. If the M button is pressed, the malfunctioning EED retains the EED FAIL message and accurate FF is displayed in the Master, Slave and MFD EED. Refer to Figure 1-21, sheet 6.

If the Master EED is unable to detect the fuel flow sensor signals, the solid white bar and digital readout for that engine are blanked and OFF is displayed in place of the digital readout until valid sensor signals are detected, Figure 1-21, sheet 6. The Slave EED and MFD EED Display Page mimic this behavior.

When the Master EED is made the Slave, the fuel flow solid white bars, and digital readouts (left and right) are blanked and INIT displayed in place of the digital readouts until the new Master EED displays valid data, Figure 1-21, sheet 6. If the Master EED remains in INIT mode for more than 8 seconds after the transition, INIT is replaced by OFF if the Master EED is unable to detect FF sensor signal. INIT is replaced by FAIL if an internal EED indicator failure occurs. INIT is not displayed during Slave to Master transitions.

Fuel Quantity

The left and right fuel systems contain a fuel quantity sensor. The Master EED transmits two AC signals to each sensor and receives one AC signal from each sensor to interpret and display fuel quantity. The Master EED uses the right oil pressure synchro reference from the right autosyn transformer as a source for the two transmitted AC signals. Therefore, the right oil pressure synchro reference must be present for the fuel quantity indicators to function.

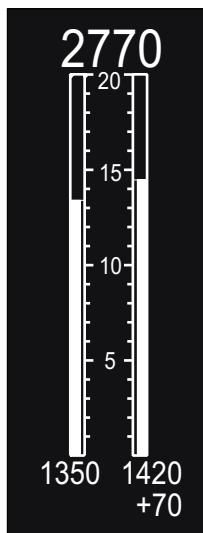

(WITH CROSSFEED SWITCH OFF)

Figure 1-16. Normal Fuel Quantity Indicator

T38002-399-1-020

The fuel quantity display consists of two vertical analog scales with respective solid bar indicators that indicate fuel quantity in pounds for each fuel system, see Figure 1-16. The solid bar indicators are colored white unless the measured quantity of that system is

250 pounds or less for more than 7.5 seconds, then the bar turns red. When the bar is red the EED activates the cockpit caution light panel FUEL LOW light. The digital readout located at the bottom of each EED indicator display is colored white and displays the individual systems fuel quantity up to four digits in 10 pound increments. The digital readout located at the top of the EED indicator display is colored white and displays total fuel quantity up to four digits in 10 pound increments. There are white tic marks labeled and spaced in 100 pound increments with numerical indicators in 500 pound intervals. A digital display of up to three digits of the fuel quantity difference between the two fuel systems is displayed with a leading + sign in 10 pound increments under the digital readout of the system with the greater fuel quantity. The imbalance indication is as follows:

- a. 0-50 pounds difference - no display.
- b. 60-190 pounds difference - white.
- c. ≥ 200 pound difference - red.

When the CROSSFEED switch is in the ON position, the top of the two solid bar fuel quantity indicators are attached with a solid magenta line, see Figure 1-17.

If an internal failure is detected by the Master EED which prevents the accurate display of fuel quantity, the solid white bar is blanked, EED FAIL is displayed in the Master EED message window, and FAIL is displayed in the place of the digital readout of the failed indicator in the Master, Slave and MFD EED. When the CROSSFEED switch is in the ON position, the magenta crossfeed indicator is drawn horizontally from the system (side) that has valid data. If both left and right systems display FAIL, the magenta crossfeed indicator is not displayed. If the M button is pressed, the malfunctioning EED retains the EED FAIL message and accurate fuel quantity is displayed in the Master, Slave and MFD EED. Refer to Figure 1-21, sheet 7.

If the Master EED is unable to detect the fuel quantity sensor signals or the right oil pressure synchro reference, the solid bar indicator and digital readout for that fuel system and total fuel quantity are blanked and OFF is displayed in place of the digital readouts until valid signals are detected, Figure 1-21, sheet 7. If the CROSSFEED switch is in the

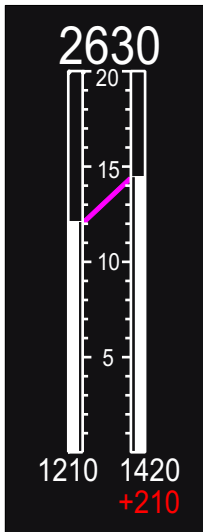

(WITH CROSSFEED SWITCH ON)

T38002-399-2-020

Figure 1-17. Normal Fuel Quantity Indicator

ON position, the magenta crossfeed indicator is drawn horizontally from the system (side) that has valid data. If both left and right systems are OFF, the magenta crossfeed indicator is not displayed. The Slave EED and MFD EED Display Page mimic this behavior.

When the Master EED is made the Slave, the fuel quantity solid bars and digital readouts (left, right, and total) are blanked with INIT displayed in place of the digital readouts until the new Master EED displays valid data, Figure 1-21, sheet 7. If the Master EED remains in INIT mode for more than 8 seconds after the transition, INIT is replaced by OFF if the Master EED is unable to detect the fuel quantity sensor signals. INIT is replaced by FAIL if an internal EED indicator failure occurs. INIT is not displayed during Slave to Master transitions.

NOTE

After the INIT period, the indicated fuel quantity may take a few seconds to stabilize.

EED MESSAGE WINDOW

An EED message window is located between the fuel flow and fuel quantity indicators, Figure 1-21, sheet 3. The EED message window is activated only when an internal EED failure occurs. There are three separate

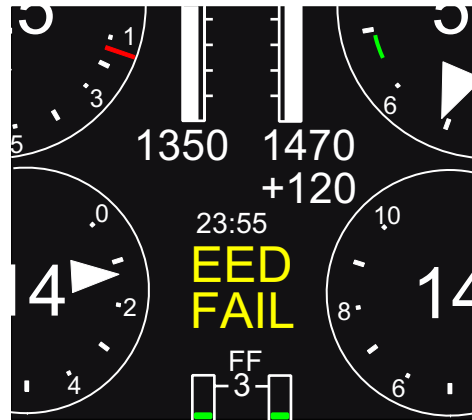

T38002-397-1-021

Figure 1-18. EED Fail Indicator

messages, EED FAIL, BIT FAIL, and EED HOT that can be displayed in the EED message window.

EED FAIL INDICATOR

When either the Master or Slave EED detects an internal failure that prevents the EED from displaying accurate indicator specific data, EED FAIL is displayed in the EED message window, Figure 1-18. If the EED with the failure is the Master, FAIL is also displayed in place of the digital readout of the failed indicator, see indicator specific discussions this section. An AVIONICS caution is also displayed in the HUD and both MFD message windows. A FWD and/or AFT EED FAILURE PFL is generated as well. Refer to WARNING CAUTION ADVISORY (WCA) SYSTEM, section I and/or III.

NOTE

If the Master EED displays EED FAIL, the Slave EED should be made the Master.

EED BIT FAIL INDICATOR

When either the Master or Slave EED detects an internal failure that is not related to indicator display data, BIT FAIL is displayed in the EED message window and none of the EED indicators display FAIL, see Figure 1-19. BIT FAIL is only displayed on

the EED that has failed. The other EED or the MFD EED does not repeat the BIT FAIL. An AVIONICS caution is also displayed in the HUD and both MFD message windows. A FWD and/or AFT EED FAILURE PFL is generated as well. Refer to WARNING/CAUTION/ADVISORY (WCA) SYSTEM, section I and/or III.

NOTE

If the Master EED displays BIT FAIL, the Slave EED should be made the Master.



T38002-397-2-021

Figure 1-19. EED Bit Fail Indicator

EED HOT INDICATOR

An internal EED over temperature situation arises when the internal EED display temperature exceeds limits. In an over temperature situation, the display brightness is reduced by 50% (Day Mode only) and EED HOT is displayed in the EED message window, see Figure 1-20. EED HOT is only displayed on the EED that has the over temperature condition. An AVIONICS caution is also displayed in the HUD and both MFD message windows. A FWD and/or AFT EED HOT PFL is generated as well. Refer to

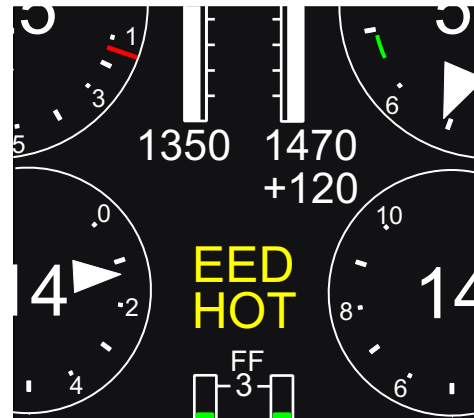

T38002-397-3-021

Figure 1-20. EED Hot Indicator

WARNING/CAUTION/ADVISORY (WCA) SYSTEM, section I and/or III. If the overtemperature remains for another minute, the EED Display back lights turn off.

NOTE

If the Master EED experiences an over temperature where the display back lights are turned off, the EED continues to process and transmit engine data to the Slave EED and MFD EED.

Loss of Engine and Fuel Sensor Input

The Master EED continuously monitors the individual engine and fuel sensors to verify that new sensor data is being received. If the Master EED senses that engine and/or fuel sensor data is not available, OFF is displayed in place of the digital readout. Refer to specific indicator discussions, this section. An ENGINE caution is also displayed in the HUD and both MFD message windows. A PFL is generated as well. Refer to WARNING/CAUTION/ADVISORY (WCA) SYSTEM and PILOT FAULT LIST, section I and/or III.



EED POWER UP - INIT MODE



EED NORMAL DISPLAY (AFTER POWER UP)
EXTERNAL POWER



EED NORMAL DISPLAY (BATTERY POWER)



EED NORMAL DISPLAY (BATTERY POWER)
GAGE TEST

T38002-474-1-020

Figure 1-21. Electronic Engine Display (EED) (Sheet 1 of 7)



EED NO SOURCE DATA DETECTED FROM EXTERNAL SENSOR
(LEFT AND RIGHT RPM, LEFT AND RIGHT EGT)



EED NO SOURCE DATA DETECTED FROM EXTERNAL SENSOR
(LEFT AND RIGHT NOZ, LEFT AND RIGHT OIL, LEFT AND RIGHT FF, LEFT AND RIGHT FUEL QUANTITY)

T38002-474-2-020

Figure 1-21. Electronic Engine Display (EED) (Sheet 2)



BIT FAIL DISPLAY



EED FAIL DISPLAY (LRPM)



EED HOT DISPLAY

Figure 1-21. Electronic Engine Display (EED) (Sheet 3)

EED OPERATION DISPLAY MODES

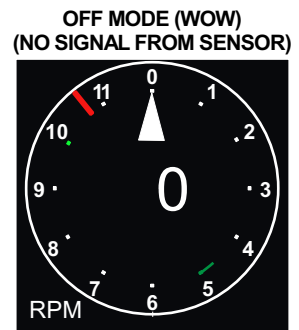
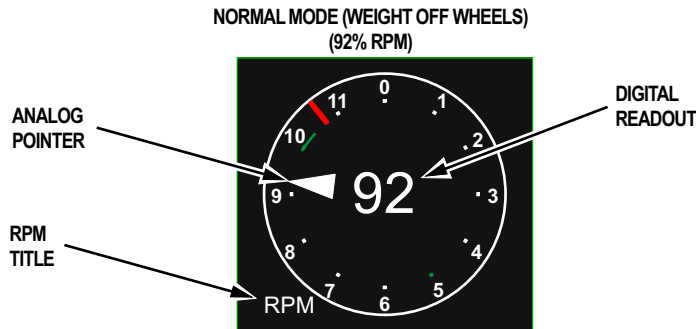

ENGINE TACHOMETER (RPM) INDICATOR

NOTE

EGT LIMITS IN MIL/MAX
POWER ARE 630-650°C

NORMAL MODE
(92% RPM)

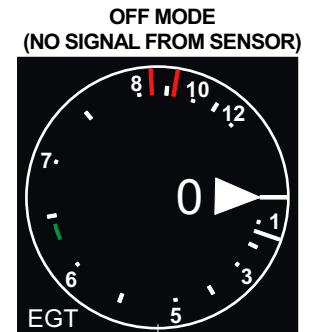

EXHAUST GAS TEMPERATURE (EGT) INDICATOR

T38002-474-4-020

Figure 1-21. Electronic Engine Display (EED) (Sheet 4)

EED OPERATION DISPLAY MODES

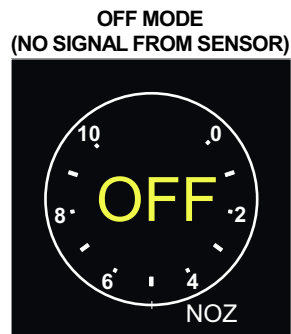
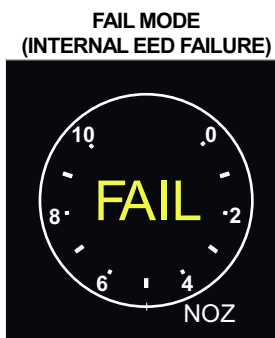
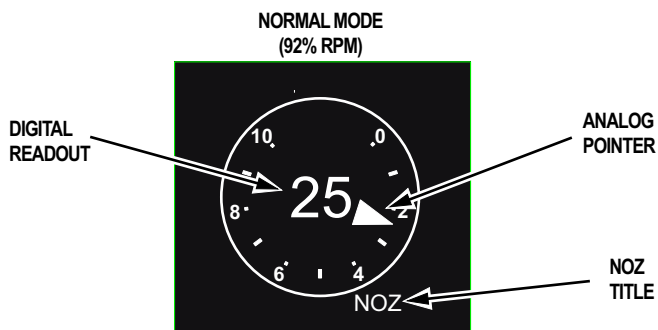

NOZZLE POSITION (NOZ) INDICATOR

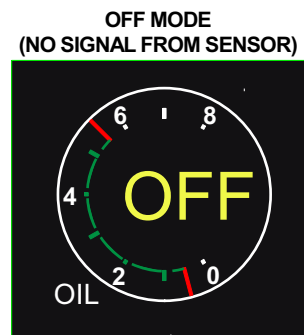
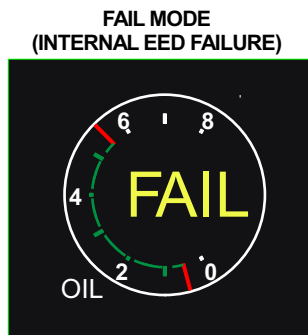
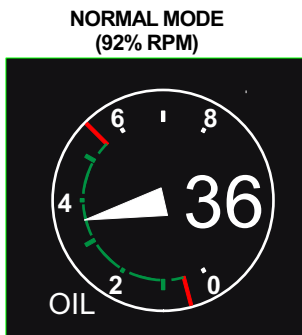

OIL PRESSURE (OIL) INDICATOR

T38002-474-5-020

Figure 1-21. Electronic Engine Display (EED) (Sheet 5)

EED OPERATION DISPLAY MODES

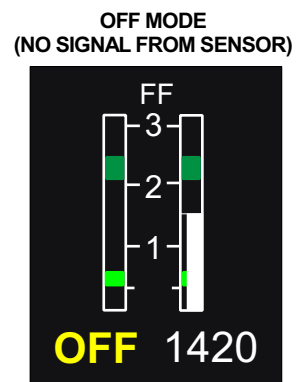
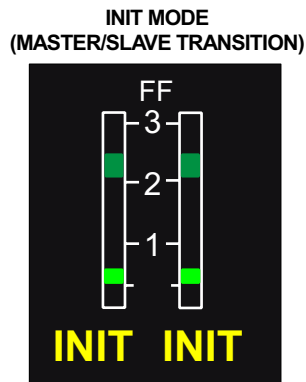
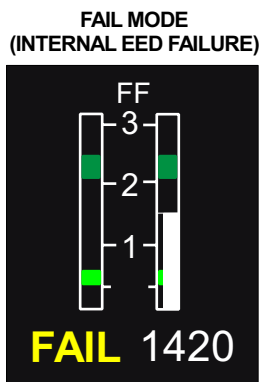
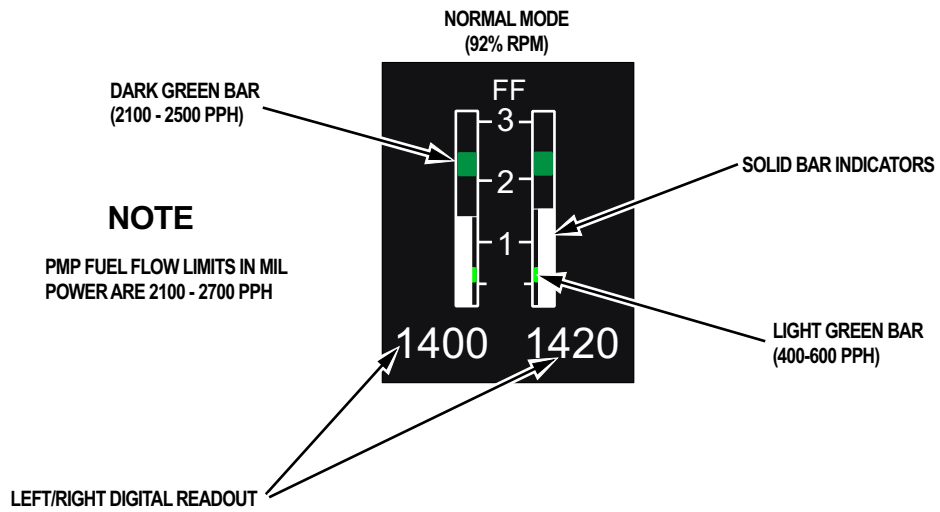

FUEL FLOW (FF) INDICATOR

EED OPERATION DISPLAY MODES

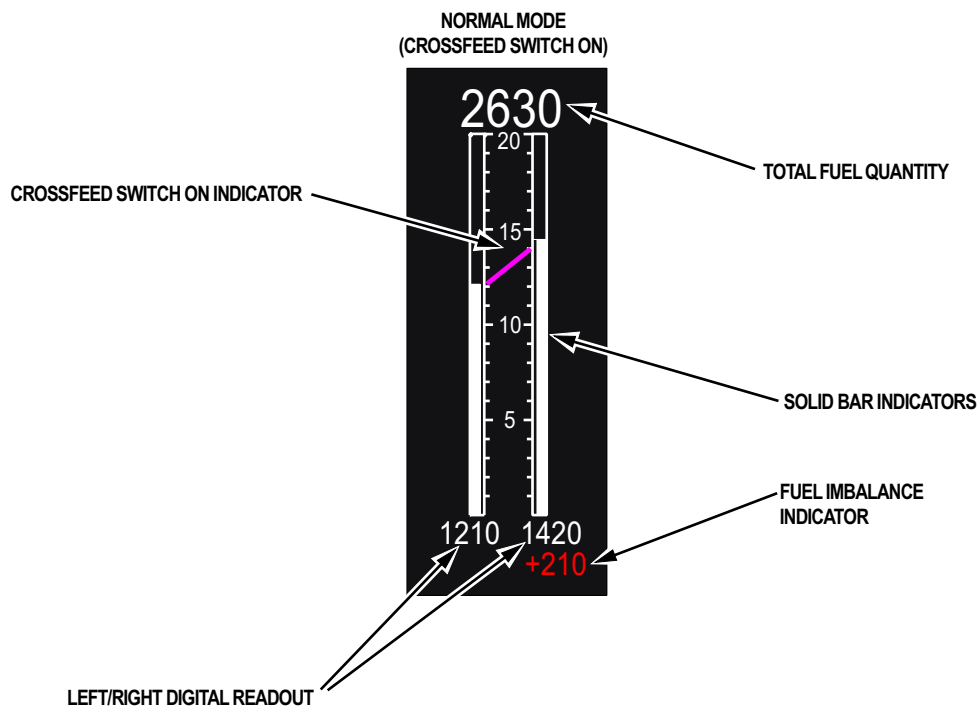

**FAIL MODE
(INTERNAL EED FAILURE)
(CROSSFEED SWITCH ON)**

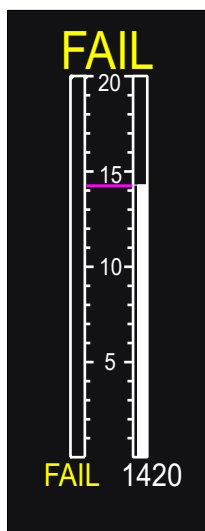

**INIT MODE
(MASTER/SLAVE TRANSITION)**

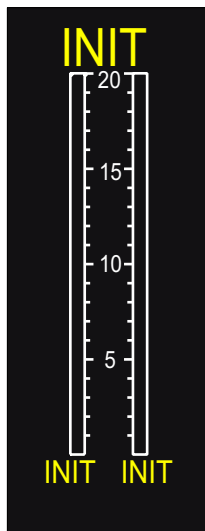

**OFF MODE
(NO SIGNAL FROM SENSOR)
(CROSSFEED SWITCH ON)**

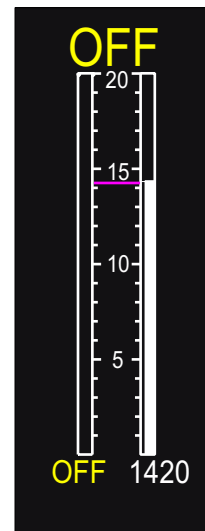

FUEL QUANTITY INDICATOR

Figure 1-21. Electronic Engine Display (EED) (Sheet 7)

AFTERBURNER SYSTEM

Each afterburner system contains an igniter plug, afterburner pilot manifold, afterburner main manifold, and afterburner fuel pump and control. Afterburner operation is initiated by advancing the throttle from the MIL detent into the MAX range. Thrust is variable within MAX range. The total rate of fuel flow at full MAX position for each engine at sea level on a standard day is approximately 7300 pounds per hour with the aircraft at rest and 11,400 pounds per hour at Mach 1.

FUEL CONTROL SYSTEM

Each engine has a main fuel control system and an afterburner fuel control system, Figure 1-22.

MAIN FUEL CONTROL

The main fuel control system consists primarily of a two-stage engine-driven pump, a main fuel control and an overspeed governor.

The main fuel control selects engine power by metering fuel to the main engine combustor as a function of throttle position, engine inlet air temperature, compressor discharge pressure and engine speed. The main fuel control performs the following functions automatically:

- a. Regulates engine speed at the selected throttle position, limit engine minimum speed at IDLE and engine maximum speed at MIL and MAX range power.
- b. Limits main engine fuel flow to safe levels during starts and during rapid throttle changes, providing protection from overtemperature, stalls, and flameouts.
- c. Limits main engine fuel flow to a preset minimum by holding combustor fuel-air ratio at or above the proper level for low power settings and for engine restart during flight.
- d. Correctly positions the compressor inlet guide vanes and air bleed valves.

AFTERBURNER FUEL CONTROL

The primary function of the afterburner fuel control is to initiate and schedule fuel flow to the afterburner main and pilot spraybars. Fuel flow is metered as a function of throttle position and compressor discharge pressure. The afterburner fuel control also senses and regulates variable area nozzle position and automatically limits fuel flow to prevent overtemperature in case of a nozzle actuating system malfunction or during rapid throttle advances into MAX range.

OIL SYSTEM

Each engine has an independent oil supply and lubrication system. The reservoir has a normal oil capacity of 4 quarts and an air expansion space of 1 quart. Heat from the engine oil is dissipated through a fuel-oil cooler. Oil consumption through engine operation and overboard venting caused by condensation and aerobatic flight should not exceed 1 pint per hour. Refer to Figure 1-281, SERVICING DIAGRAM.

AIRFRAME MOUNTED GEARBOX

An airframe mounted gearbox for each engine operates a hydraulic pump and an AC generator. A shift mechanism keeps AC generator output within an acceptable frequency range. Gearbox shift occurs in the 65 % to 75 % RPM range.

**T.O. 1T-38C-1
ENGINES**

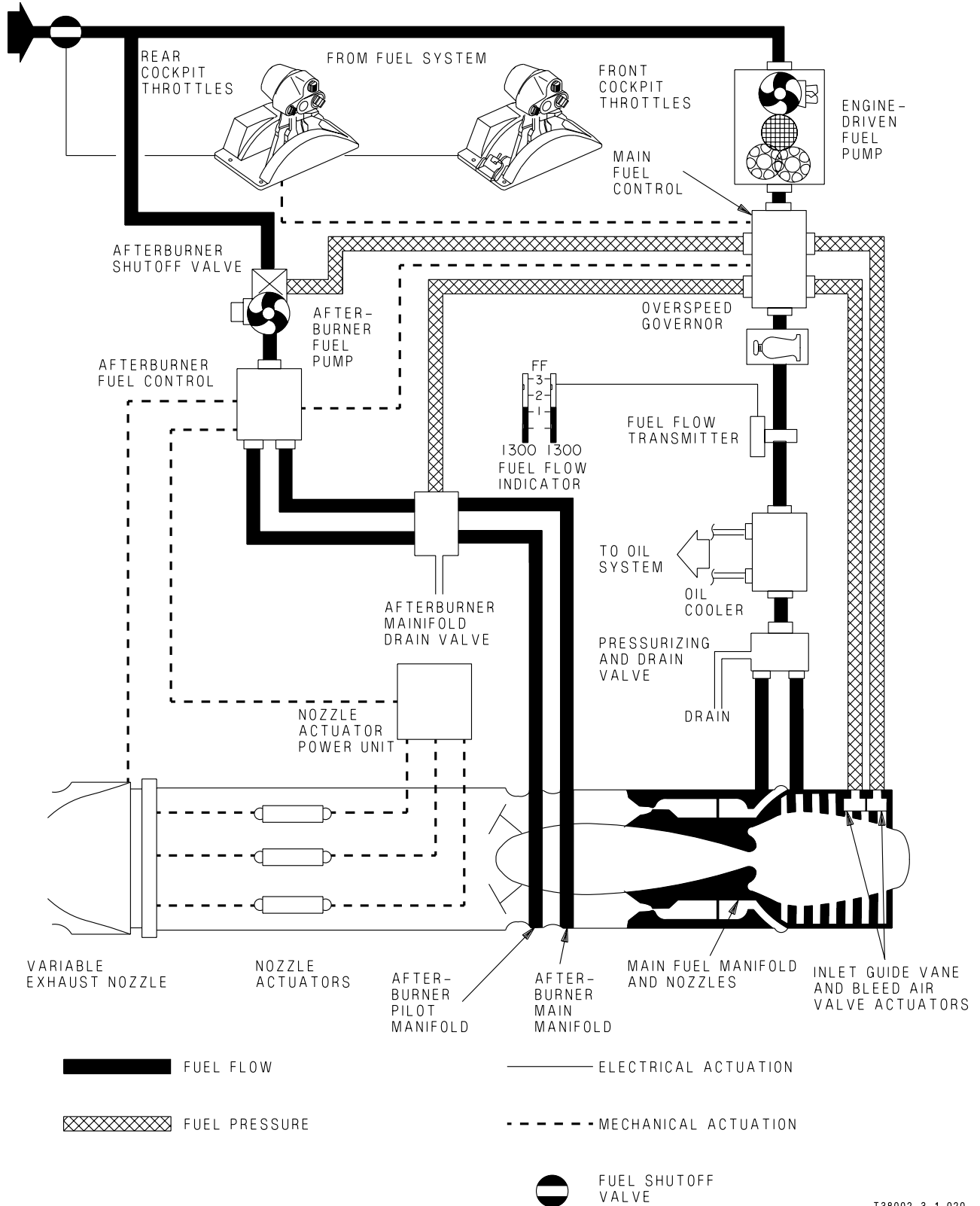

T38002-3-1-020

Figure 1-22. Engine Fuel Control System

FIRE WARNING AND DETECTION SYSTEM

The fire warning and detection system gives a warning of a fire or overheat condition in the respective engine bay. Heat detectors are located in the forward engine bay and boattail area for each engine. The system responds to an overall average temperature or to highly localized temperatures caused by flame or hot gas.

There are two red engine fire warning lights (each containing two bulbs) placarded FIRE, one for each engine, on the instrument panel in each cockpit. Together with the HUD and MFD displays, they warn of an overheat or fire condition in either engine compartment. When the fire detection system senses an overheat condition or fire, both bulbs in the FIRE warning light for the respective engine illuminate. This light remains on until the condition is corrected. Should the overheat condition or fire recur, the light illuminates again.

Operation of the system in each engine compartment is independent of the other except when testing the system using the WARNING TEST Switch. Placing either cockpit WARNING TEST Switch in TEST checks all system detectors and the four fire warning light bulbs in each cockpit. Refer to WARNING/CAUTION/ADVISORY (WCA) SYSTEM, this section.

NOTE

Illuminated fire warnings and lights can be valid fire indications even though the test circuit may be inoperative.

ENGINE COMPRESSOR STALLS AND FLAMEOUTS

A compressor stall is an aerodynamic interruption of airflow through the compressor section. Factors that can increase the stall sensitivity and decrease the compressor stall margin are:

- a. Foreign object damage
- b. High aircraft angles of attack at low airspeeds
- c. Low Compressor Inlet Temperatures (CIT)
- d. Maneuvering flight
- e. Unusual flight attitudes
- f. Atmospheric variations
- g. Jet wash

- h. Temperature and pressure distortion
- i. Ice formation on inlet ducts
- j. Engine inlet guide vanes or a combination of the above.

Compressor stalls can be caused by various other factors such as: engine component malfunction, incorrect engine rigging, incorrect RPM and fuel flow trim, throttle burst to MIL or MAX power at high altitude and low airspeed, and hot gas ingestion. Compressor stalls can lead to a flameout.

At low altitude the stall is typically recognized by a pop or bang followed by an audible buzzing sound and vibration, accompanied by a rapid RPM drop and high EGT. The stall should be cleared as soon as possible to prevent engine damage by overtemperature. The stall can be cleared by rapidly retarding throttle to IDLE and immediately pushing the ENGINE START Button.

At high altitude the stall is typically recognized by an audible chug or pop accompanied by a rapid RPM drop and decreasing EGT. The stall may be cleared by rapidly retarding the throttle to IDLE and immediately pushing the ENGINE START Button.

Variable inlet guide vanes and air bleed valves reduce the possibility of a compressor stall throughout the normal operating range of the engine. The vanes function automatically to direct the flow of air to the compressor blades at the proper angle. The bleed valves open and close automatically to provide proper control of compressor pressure.

Flameouts can result from the same conditions that cause compressor stalls. During a flameout, the aerodynamic disruption causes combustion to cease and the engine rapidly winds down to windmilling RPM. The flameout is recognized by an audible sound similar to a compressor stall, however, both RPM and EGT rapidly decrease. Immediately pulling the throttle to idle and pushing the ENGINE START Button provides a restart attempt during the wind down and can recover the engine to idle.

ENGINE COMPRESSOR STALL/FLAMEOUT SUSCEPTIBILITY AREA

Figure 1-23 depicts the stall/flameout prone areas for the J85-GE-5 series engine. The chart is presented in terms of pressure altitude versus indicated Mach

T.O. 1T-38C-1 ENGINES

number for standard day conditions with considerations for temperature deviation of $\pm 10^{\circ}\text{C}$ from standard. The chart illustrates the operating airspace at higher altitudes where colder temperatures and less dense air can cause the engine to stall or flameout. This operating restriction is further expanded as temperatures colder than standard are encountered. Conversely, the opposite is true as temperatures warmer than standard are encountered. These regions of flight require pilot attention and have been portrayed on the chart as the black striped and shaded areas. Flight is not prohibited in these areas but merely requires the pilot to acknowledge the engine susceptibility as indicated on the chart.

THROTTLE MOVEMENT

The engine stall margin and operating parameters decrease with increasing altitude where the air is colder and less dense. As a result, throttle movement must be more carefully controlled in the black striped and shaded areas shown in Figure 1-23. Abrupt throttle movements, which are acceptable to the engine outside the shaded areas, are not recommended in the shaded areas and can result in a stall or flameout.



If one engine compressor stalls or flames out within the black striped or shaded areas, do not abruptly move the other throttle as a dual engine compressor stall/flameout situation is likely to occur.

AFTERBURNER INITIATION (HIGH ALTITUDE)

Afterburner initiation attempts in the black striped area in Figure 1-23 are not recommended. Afterburner light-off is not guaranteed and, even if successful, can drive the engine RPM down (rollback) and possibly cause engine flameout.

NOTE

To increase the probability of afterburner light-off if required in the black striped area, increase airspeed as much as practical before initiating afterburner.

MANEUVERING

Maximum performance maneuvering involves high Angle Of Attack (AOA), low airspeed, unusual attitudes, high yaw, roll, and pitch rates, and throttle manipulation, which increase the engine susceptibility to compressor stall and flameout. Throttle manipulation demanding more engine air increases the possibility of stall/flameout. The area below approximately 28,000 feet and above 0.6 Indicated Mach Number (IMN) has not been a stall/flameout prone area because ram air in the higher speed range is sufficient to satisfy engine requirements. However, excessive heavy maneuvering and throttle movements broaden the susceptible area indicated on the chart.



Flight above approximately 28,000 feet and below 0.6 IMN (Figure 1-23, shaded area) has proven to increase susceptibility to stall/flameout due to reduced/distorted ram air flow to the engine, caused by lower air density coupled with reduced effective intake area.

High Mach Dive



Avoid afterburner operation as indicated in the solid black area of Figure 1-23. Engine stall or damage to the variable exhaust nozzles can occur.

T² Cutback

The T² sensor in the main fuel control automatically reduces the physical RPM and EGT (T² cutback) to prevent over-pressurization and high corrected speed conditions of the compressor at low CIT. At any normal operating condition, CIT is higher than the Outside Air Temperature (OAT) and varies with airspeed for a given OAT. Increasing airspeed increases CIT. At low airspeeds and low OAT conditions, the engine RPM and EGT indications can be below the normal operating limits at MIL and MAX power. When the aircraft is flown in the striped black area of the engine envelope, Figure 1-23, T² cutback can be observed. In maneuvering flight, the CIT of each engine varies depending on flight attitude. As a result, the engine sensing the lower CIT has a

**1G LEVEL FLIGHT
DATA BASE: FLAMEOUT STATISTICS**

AFTERBURNER INITIATION NOT RECOMMENDED IN THIS AREA

ONLY NORMAL CRUISE OPERATIONS RECOMMENDED IN THIS AREA

ALL THROTTLE MANIPULATIONS MUST BE SLOW AND SMOOTH (NOT TO EXCEED ONE INCH MOVEMENT IN 3 SECONDS MEASURED AT THE THROTTLE QUADRANT)

CAUTION

FLIGHT ABOVE APPROX. 28,000 FEET AND BELOW 0.6 INDICATED MACH NUMBER (IMN) (SHADED AREA) HAS PROVEN TO INCREASE SUSCEPTIBILITY TO STALL/FLAMEOUT DUE TO REDUCED/DISTORTED RAM AIR FLOW TO THE ENGINE, CAUSED BY LOWER AIR DENSITY COUPLED WITH REDUCED EFFECTIVE INTAKE AREA.

NOTE

EXCESSIVE YAW AND ANGLE OF ATTACK EXPANDS THE AREAS OF SUSCEPTIBILITY.

FLIGHT OUTSIDE OF THIS ENVELOPE NOT RECOMMENDED

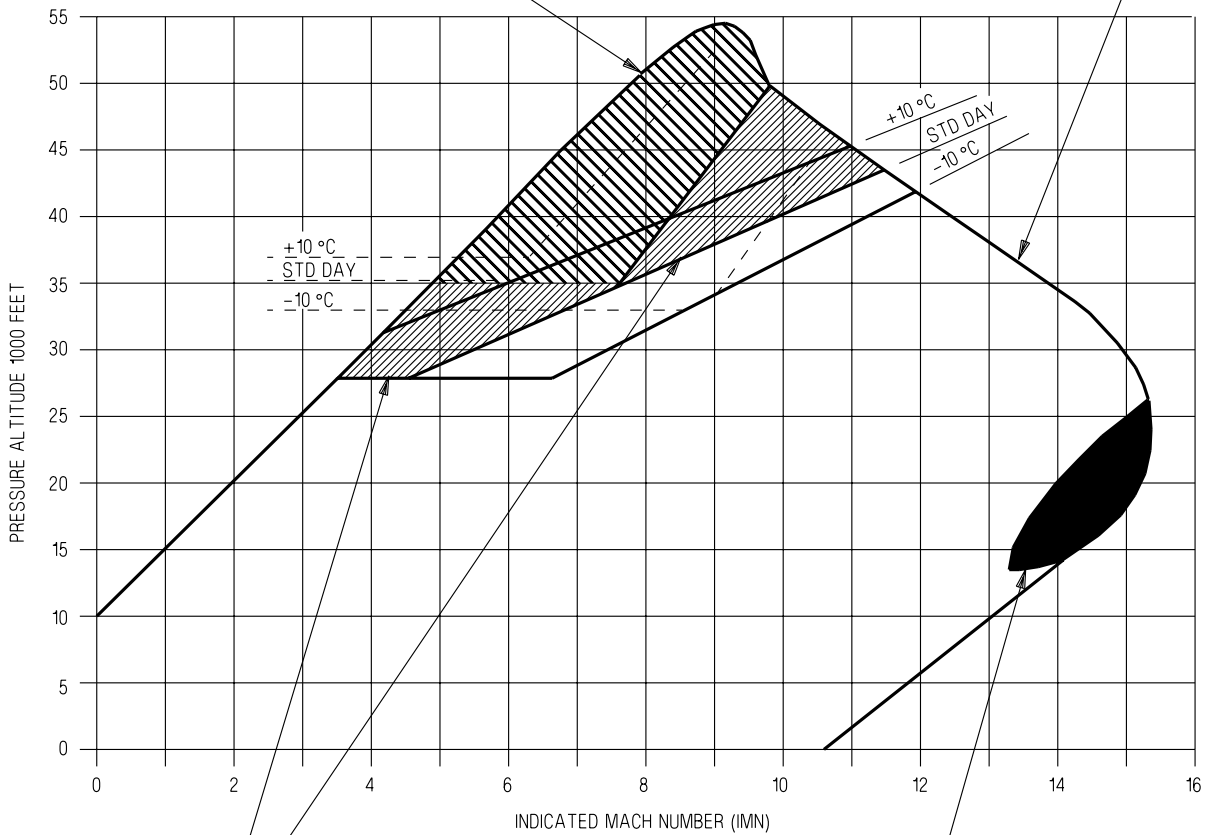

RAPID OR ABRUPT THROTTLE MOVEMENT (ENGINE ACCEL) TO MILITARY OR AB POWER ABOVE THIS LINE (SHADED AREA) MAY CAUSE ENGINE STALL OR FLAMEOUT AND IS NOT RECOMMENDED

AVOID AFTERBURNER OPERATION IN THIS AREA

T38002-35-1-021

Figure 1-23. Engine Compressor Stall/Flameout, Susceptibility Areas

T.O. 1T-38C-1 ENGINES

decreased stall margin and increased probability of compressor stall if a throttle transient is made. If T² cutback is observed, the airspeed should be increased by exchanging altitude for airspeed to increase CIT prior to making a throttle movement.

EGT Droop

At low altitude and high airspeed (500 KCAS), EGT droop can occur with engine at military power when accompanied by 3% or less nozzle indication.

Effect of High Altitude And Low Airspeed On Engine RPM

During 1.0 g stalls at or above 20,000 feet, with throttles at IDLE and airspeed 200 KCAS or below, the inflight idle RPM can decay to less than normal

ground idle speed (46% to 50% RPM) and the generator caution lights illuminate. Under these flight conditions, an engine on which RPM has dropped below normal idle speed does not accelerate when the throttle is advanced. To avoid this condition, maintain engine RPM at 80% or above when airspeeds of less than 200 KCAS above 20,000 feet are anticipated. Corrective action for idle decay is to retard the throttle of the affected engine(s) to idle and increase airspeed to above 200 KCAS by lowering the nose of the aircraft. As airspeed increases, throttle advances may be attempted; however, the throttle should be returned to IDLE if the engine does not accelerate.

FUEL SYSTEM

FUEL SYSTEM OVERVIEW

The T-38C has an independent fuel system for each engine, Figure 1-24, interconnected by a DC operated crossfeed valve. The left and right system fuel cells are in the fuselage. Normally, the left engine is supplied by the left system (forward fuselage cell and the forward and aft dorsal cells). The right engine is supplied by the right system, (center and aft fuselage cells). Each system (left and right) contains the following:

- a. A fuel boost pump which provides fuel under pressure to the engine driven fuel boost pump during normal operations.
- b. A fuel filter system is integrated and a bypass is incorporated into the system to prevent engine flame-out due to lack of fuel flow through a clogged filter.
- c. A shutoff valve controls fuel flow from the boost pump to the engine. Operation of the shutoff valves is controlled via the associated engine throttle or respective FUEL SHUTOFF Switch located on the left sub-panel in the FCP.
- d. A fuel pressure caution light is provided for each system on the WARNING/CAUTION/ADVISORY (WCA) PANEL to alert the aircrew of fuel pressure loss (low fuel level at the boost pump or boost pump failure).

The designated primary fuel for the aircraft is JP-8. Refer to STRANGE FIELD PROCEDURES Section II, for alternate and emergency fuel operating information.

The T-38C is normally refueled by the single-point system which provides a total of 3,906 pounds (at 60° F) of usable JP-8 fuel, 1,990 pounds in the right system and 1,916 pounds in the left system. If single-point adapters are not available on ground equipment or if either of the automatic shutoff valves (primary / secondary) are inoperative, the tanks may be refueled manually (over-the-top) through the manual filler caps. When manual refueling is accomplished, the usable fuel provided is 3,866 pounds (at 60° F) of JP-8.

NOTE

When refueling manually, ensure the left system is fueled first to prevent the aircraft from sitting on its tail due to a center of gravity imbalance.

FUEL BOOST PUMPS

A single AC driven fuel boost pump in each system supplies fuel under pressure to the engine-driven fuel pump during normal operation. The left system boost pump is in the inverted flight reservoir of the forward fuselage cell, and the right system boost pump is in the inverted flight reservoir of the aft fuselage cell. Without the aid of the boost pump, each engine can be supplied with fuel by gravity flow from its respective system. Normally, sufficient fuel flows by gravity to maintain MAX power from sea level up to approximately 25,000 feet MSL; however, by specifications, gravity flow is guaranteed only to 6,000 feet MSL, and flameouts have occurred as low as 7,000 feet MSL. Through crossfeed operation, both systems can supply fuel to either engine with or without boost pump pressure (one engine off, crossfeed ON, boost pumps functioning or failed). Also, one system under boost pump pressure will supply fuel to both engines, (both engines operating, crossfeed ON, one boost pump OFF). Caution lights on the WCA panel indicate fuel low level and low fuel pressure conditions. Refer to the SERVICING DIAGRAM, Figure 1-281, this section, for fuel specification and fuel quantity data. Refer to FUEL BALANCING, Section II, for proper crossfeed operation.

BOOST PUMPS SWITCHES

Two guarded BOOST PUMPS Switches, one for each fuel system, are located on the FUEL CONTROLS panel of the FCP. All fuel pump circuit breakers should be closed before operating boost pumps.

BOOST PUMPS INDICATOR LIGHTS

Two BOOST PUMPS indicator lights, are located on the FUEL CONTROLS panel of the RCP. An indicator light illuminates when the corresponding BOOST PUMPS Switch is placed OFF.

FUEL PRESSURE CAUTION LIGHTS

Two fuel low pressure caution lights, placarded LEFT FUEL PRESS and RIGHT FUEL PRESS, are located on the right sub-panel of each cockpit. The caution light illuminates when the warning system detects a low pressure condition. Fuel low pressure caution lights may be used to determine if boost pumps are operating. Low pressure lights are only

T.O. 1T-38C-1

FUEL

valid indications of boost pump output with crossfeed OFF, the corresponding fuel shutoff switch NORMAL, and throttle out of OFF. The caution lights may blink when afterburner is selected. Various other conditions may cause the lights to blink. This blinking is not an indication of boost pump failure.

FUEL SHUTOFF SWITCHES

Two guarded fuel shutoff switches, one for each engine, are located on the left sub-panel of the FCP. In the NORMAL position, the fuel shutoff valves (DC operated) are controlled by the throttles. Placing either switch to the CLOSED position shuts off fuel flow to the respective engine in approximately 1 second without using the throttles.



The switches should be used only in an emergency, as damage to the engine-driven fuel pumps and main fuel control may occur.

FUEL CROSSFEED

CROSSFEED SWITCH

A DC powered CROSSFEED switch, is located on the right sub-panel of the FCP. The switch is used to electrically open/close the crossfeed valve in the crossfeed fuel manifold that connects the left and right fuel systems. The switch is placed ON to use the fuel from both systems to supply one engine or to operate both engines on fuel from one system under boost pump pressure.

WARNING

- With the CROSSFEED switch ON, and either both boost pumps ON or both boost pumps OFF, a rapid fuel imbalance can occur.
- If crossfeed operation is continued until the active system runs dry, dual engine flameout will occur.

CROSSFEED Indicator Light

A CROSSFEED indicator light is located on the FUEL CONTROLS panel of the RCP. When the CROSSFEED Switch in the FCP is placed to the ON position, the CROSSFEED indicator light illuminates.

FUEL DISPLAYS

FUEL FLOW AND FUEL QUANTITY

Fuel Flow and Fuel Quantity indicators are primarily located on the EED, Figure 1-5, with secondary access available via the MFD (MDP must be operational with at least one EED turned ON). Refer to ELECTRONIC ENGINE DISPLAY (EED), this section.

FUEL LOW CAUTION LIGHT

A FUEL LOW caution light is located on the WCA panel in each cockpit. The caution light illuminates after a 7.5-second delay when a fuel quantity indicator reads below 250 pounds. The L/R Fuel Quantity indicators must be checked to determine which system is low.

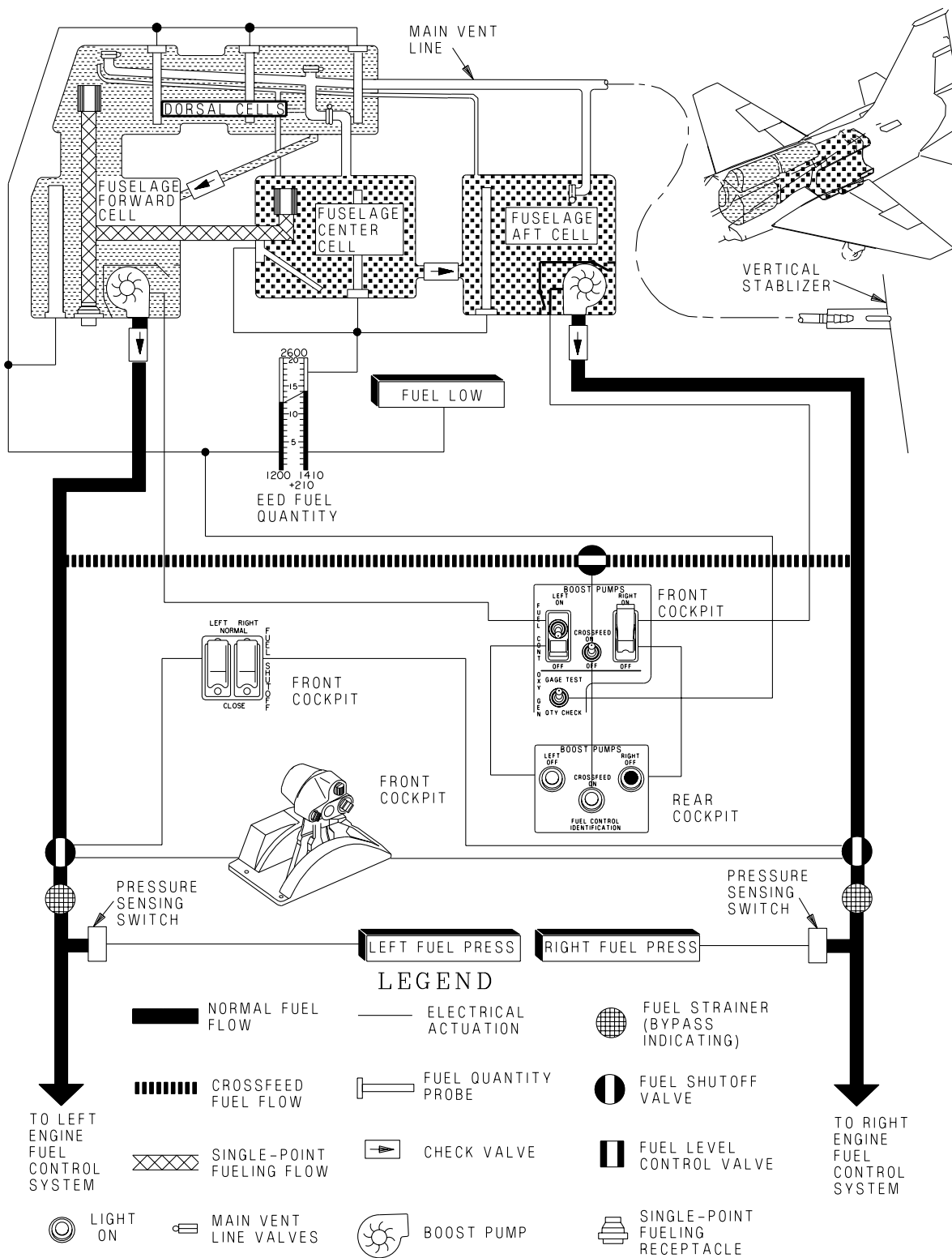

T38002-5-1-020

Figure 1-24. Fuel System (Crossfeeding)

T.O. 1T-38C-1

FUEL

FUEL MANAGEMENT

The fuel systems function automatically to supply fuel to the engines once the throttles have been moved from the OFF position and the fuel BOOST PUMPS Switches ON. The fuel quantity indicators should be monitored to maintain the two systems within 200 pounds of each other to ensure the aircraft Center of Gravity (CG) is maintained within limits.

CROSSFEEDING

Crossfeeding can be used to maintain a balanced fuel state. Crossfeeding can not be used to transfer fuel from one system to the other. Refer to FUEL BALANCING, Section II.

LOW FUEL OPERATION

If the left or right fuel system has less than 650 pounds of fuel, the surface of the fuel falls below the fuel boost pump upper inlet and boost pump output is reduced approximately 40 %.

With the FUEL LOW caution light illuminated, a slightly nose up flight attitude should be maintained to assure maximum usable fuel from both systems. Maintaining this attitude is necessary to preclude uncovering the fuel boost pump inlets (allowing air to enter the fuel supply lines) causing engine flameout.

During crossfeed operation, if the engines are operated at high power settings, the low pressure light may come on and engine RPM fluctuations may occur because of insufficient fuel pressure. With a low fuel

state (250 pounds in either system) do not attempt to ensure fuel flow to both engines by selecting crossfeed operation with both fuel boost pumps operating. If the fuel supply in one system is depleted or is pulled away from the boost pump by g forces and the boost pump in the other system fails, air may be supplied to the engines causing dual engine flameout. In this situation, there is no cockpit indication of boost pump failure.



Taxi operations with less than 150 pounds in either fuel system could cause cavitation of the boost pump of that system resulting in engine flameout during turns and low power settings.

NOTE

During low fuel state descents do not maintain a nose down attitude for extended periods. Occasionally transit to a positive pitch attitude to refill the boost pump sump.

Single Engine Low Fuel Operation

With less than 250 pounds of fuel remaining in either system, place both boost pumps ON and CROSS-FEED switch ON to allow the engine to be fed from both systems simultaneously.

ELECTRICAL SYSTEMS

Two alternating current (AC) systems and three direct current (DC) systems supply electrical power to the aircraft, see Figure 1-25. The 115/200 volt AC power supply systems consist of two identical engine-driven AC generator systems and an external power receptacle. The DC power supply systems consists of two Essential DC busses and one Nonessential DC bus, powered either by two 50 amp DC transformer-rectifiers or a 24 volt sealed lead acid battery. The system also contains circuit breakers and fuses.

AC POWER SYSTEM

AC power is normally obtained from two engine-driven AC generators. Power distribution is divided into a right system and a left system. The generators come on line individually when engine speed accelerates to approximately 43% to 48% RPM. Both generators operate at 115 \pm 2 volts, providing three phase AC. If one generator fails or is turned off, the functioning generator automatically supplies electrical power to both systems through the bus contactor relay. Automatic transfer of electrical load through the interaction of both power protection panels may take up to 2.5 seconds. The power protection systems allow sustained operation of either bus with the respective generator operating at 90 volts AC. Failure of either the Left or Right AC generator without a crossover, results in loss of the associated AC BUS.

AC ADVISORY DISPLAYS

Abnormal AC electrical bus operation can result in the following:

a. Below 108 \pm 2 volts AC, the affected TRU triggers a RECTIFIER FAILURE PFL based on the reduced DC output, refer to WARNING/CAUTION/ADVISORY (WCA) SYSTEM, section I and/or III. An AVIONICS advisory is also displayed in the HUD and MFD Message Windows.

b. Left AC Bus operation below normal voltage can trigger an AVIONICS advisory in the HUD and MFD Message Windows. An ADC FAILURE PFL associated with the loss of Angle of Attack (AOA) information is also triggered. The digital AOA readout and pointer on the MFD and the HUD digital AOA display are removed. Airspeed and altitude displays remain valid on the HUD and MFD.

c. Right AC Bus operation below normal voltage can cause HUD anomalies and trigger a RECTIFIER FAILURE PFL. Typically the HUD can dim or blank off and reset to DIM. HUD brightness can be restored by the HUD Brightness Rocker Switch on the UFCP or by cycling the UFCP power switch. If the Right AC Bus voltage drops further, the MDP can shutdown. If the Right AC Bus voltage increases sufficiently, the MDP automatically reboots.

GENERATOR SWITCHES AND CAUTION LIGHTS

Two guarded generator switches, one for each generator, are located on the right sub-panel of the front cockpit. Generator caution lights, placarded LEFT GENERATOR and RIGHT GENERATOR, on the Caution Light Panel, are located on the right sub-panel of each cockpit. A caution light illuminates when its respective generator switch is placed in the OFF position or when a generator drops off line. The caution light may take up to 2.5 seconds to illuminate after a generator failure. A generator switch RESET position permits resetting the AC bus (accomplished prior to turning the affected generator switch back ON).

DC POWER SYSTEM

DC power is normally obtained through two Transformer-Rectifier Units (TRUs) which convert AC to DC power. If one TRU fails, the other automatically supplies all DC requirements. A failure of either AC generator, with no generator crossover, results in the loss of the respective TRU. Failure of the Left Essential Bus Circuit Breaker causes loss of the Left Essential DC Bus and the Non-Essential DC Bus. Failure of the Right Essential Bus Circuit Breaker causes loss of the Right Essential DC Bus. When either TRU output falls below 25.5 volts DC for more than 2 seconds, a RECTIFIER FAILURE PFL and an AVIONICS advisory are triggered. The affected TRU can still be outputting DC voltage at a lower level while the PFL is active. The TRU PFL clears when the TRU output voltage exceeds 25.5 volts DC. If both TRUs fail, the MASTER CAUTION light on the instrument panel and XMFR RECT OUT light on the caution light panel illuminates. A blinking CAUTION is displayed in both the MFD and HUD Message Windows. Under this condition, the Essential DC busses revert to battery power, and

T.O. 1T-38C-1

ELECTRICAL

power is removed from the Nonessential DC bus. The XMFR RECT OUT light can flicker during afterburner ignition.

BATTERY SWITCH

A battery switch is located on the right sub-panel of the front cockpit. Placing the switch ON connects the battery to the DC bus. Under normal flight conditions, the battery switch should remain ON to permit the battery to charge. A minimum battery voltage of 18 volts is required to close the battery relay. After the battery relay is closed, the battery should remain on until the voltage drops below approximately 10 volts.

DC BUSES

The Battery Bus is tied directly to the Left and Right Engine Start Controls, the left and right engine afterburner controls and the Static Inverter. DC power is available to these functions as long as the Battery Switch is ON and the battery has a charge. The DC output voltage from TRUs 1 and 2 are paralleled through a diode module to provide a single output to the DC busses. There is no interruption of DC power if a TRU fails because the functioning TRU is connected to all DC buses through the diode module.

See Figure 1-25 for a listing of the components powered through these busses. In the event of a dual TRU failure, the nonessential bus deenergizes and the battery supplies the two essential busses for a minimum of 15 minutes.

STATIC INVERTER

A static inverter, powered by the battery bus, converts the DC bus voltage to 115 Volts Alternating Current (VAC). The inverter, when activated, provides an alternate source of AC power for the following:

- a. First engine start on the ground or during flight.
- b. Operation of right engine autosyn instruments (fuel flow, oil pressure) and left and right fuel quantity sensors.
- c. Oxygen quantity indicators.

On the ground, with DC power only, the inverter is activated when either engine start button is pressed or when the OXY/FUEL check switch is held in the GAGE TEST or QTY CHECK position. During flight, with DC power only, the inverter is activated when either engine start button is pressed or either throttle is moved into MAX range, or when the OXY/FUEL check switch is held in GAGE TEST or QTY CHECK position. With normal AC/DC power or DC power only, an operational check of the static inverter can be accomplished by positioning the OXY/FUEL check switch to GAGE TEST and observing counterclockwise movement of oxygen quantity indicator pointers.

**NORMAL AC POWER
(EXTERNAL POWER APPLIED)**

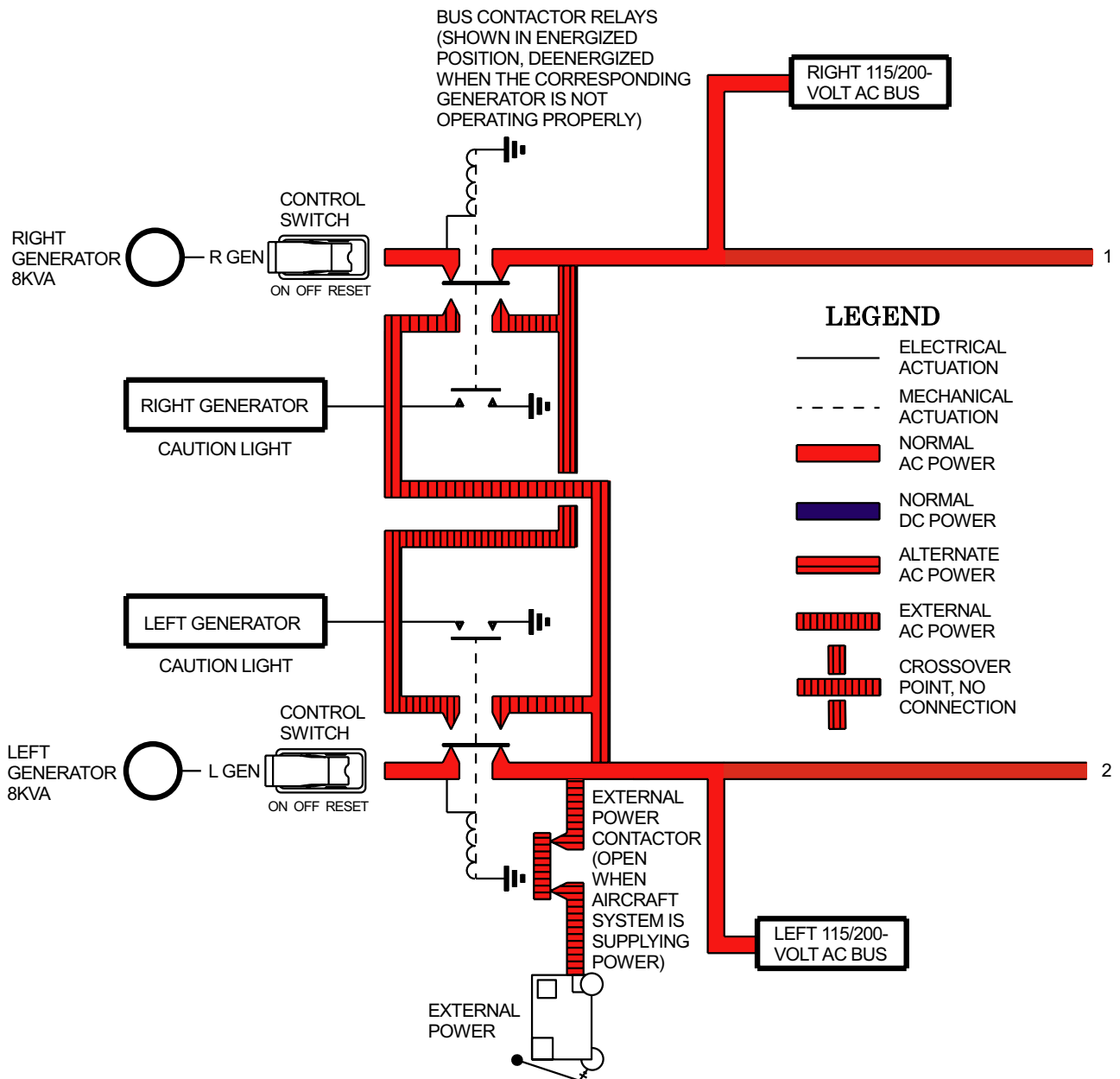

Figure 1-25. Electrical System (Sheet 1 of 6)

T38002-411-1-020

**NORMAL DC POWER
(EXTERNAL POWER APPLIED)**

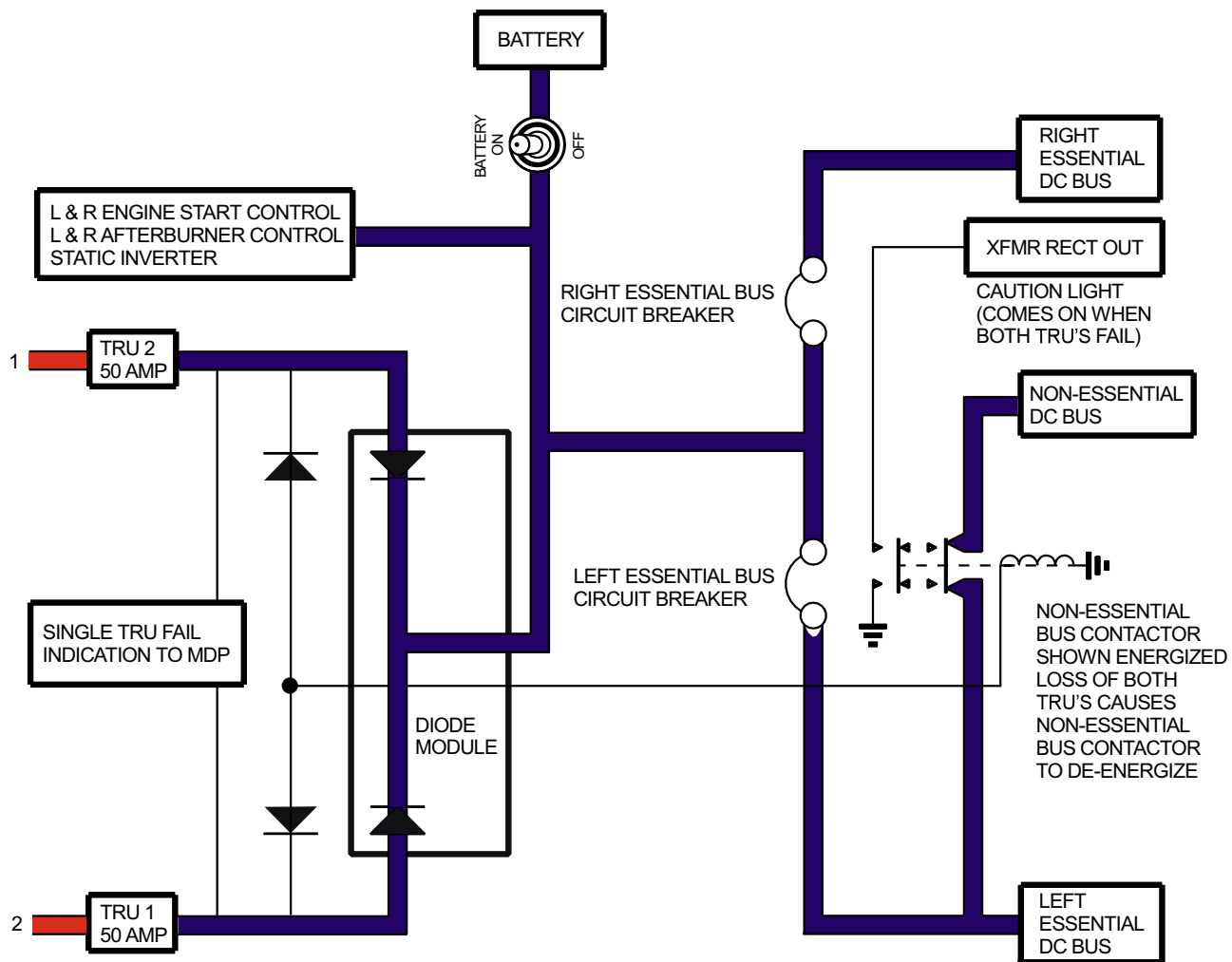

Figure 1-25. Electrical System (Sheet 2)

T38002-411-2-021

LEFT 115VAC BUS

AOA vane heater Console lights Fuel boost pump (Left) Fuel flow (Left)	Hydraulic pressure indicator (Utility) Instrument lights Landing/taxi lights	Oil pressure sensor (Left) Position lights Rotating beacons	Rudder trim control Stability Augmen- tor System (SAS)	Transformer- Rectifier Unit (TRU) #1
--	---	--	---	--

RIGHT 115VAC BUS

Air conditioning (Cabin) Anti-ice control (Engine) Canopy seal Equipment bay cooling Flap motors	Floodlights (normal) Fuel boost pump (Right) Fuel flow (Right) Fuel low warning Fuel quantity HUD	Hydraulic pressure indicator (Flight) Ignition exciters MDP Oil pressure sensor (Right) Oxygen quantity and low level warning circuit	Pitot heater Seat adjustment TAT probe heater Transformer- Rectifier Unit (TRU) #2	Trim control and light Warning/Caution/ Advisory and indicator lights (dim)
---	--	---	---	--

BATTERY 24VDC BUS

Afterburner ignition control	Engine start control	Static inverter
---------------------------------	-------------------------	-----------------

LEFT ESSENTIAL 28VDC BUS

2 AIU AOA indexer lights Avionics Activation Panel (AAP) Crossfeed valves Fire light bulb test (Left) Flap control	Floodlights (emer- gency) Formation lights Fuel shutoff IFF (Mode S tran- sponder)	1 Instrument panel map light Oxygen quantity low level warning Speedbrake	Standby attitude indicator Standby altimeter Utility lights VOR/ILS Warning/Caution/Advisory and indicator lights (bright)
--	---	---	---

RIGHT ESSENTIAL 28VDC BUS

ADC 2 AIU Data Transfer System (DTS) EED (both) EGI	Fire detection (Left & Right) Fire light test (Left & Right) Flap position indicator Generator control	Landing gear control Landing/Taxi light control Landing gear warning/tones/ lights	MFD (both) Noswheel steering Nozzle position sensor (Left & Right) Radar altimeter TACAN TCAS (limited to Standby only) UHF radio
---	--	--	---

NON-ESSENTIAL 28VDC BUS (Powered by LEFT ESSENTIAL 28VDC BUS)

Flight Loads Data Recorder (FLDR) (if installed) HUD video camera	TCAS processor	UFCP (both)	VHF radio	Video tape re- corder
--	----------------	-------------	-----------	--------------------------

NOTE

- 1** After T.O. 1T-38C-548.
- 2** AIU is powered from both Essential DC busses.

Figure 1-25 Electrical System (Sheet 3)

CIRCUIT BREAKER PANELS

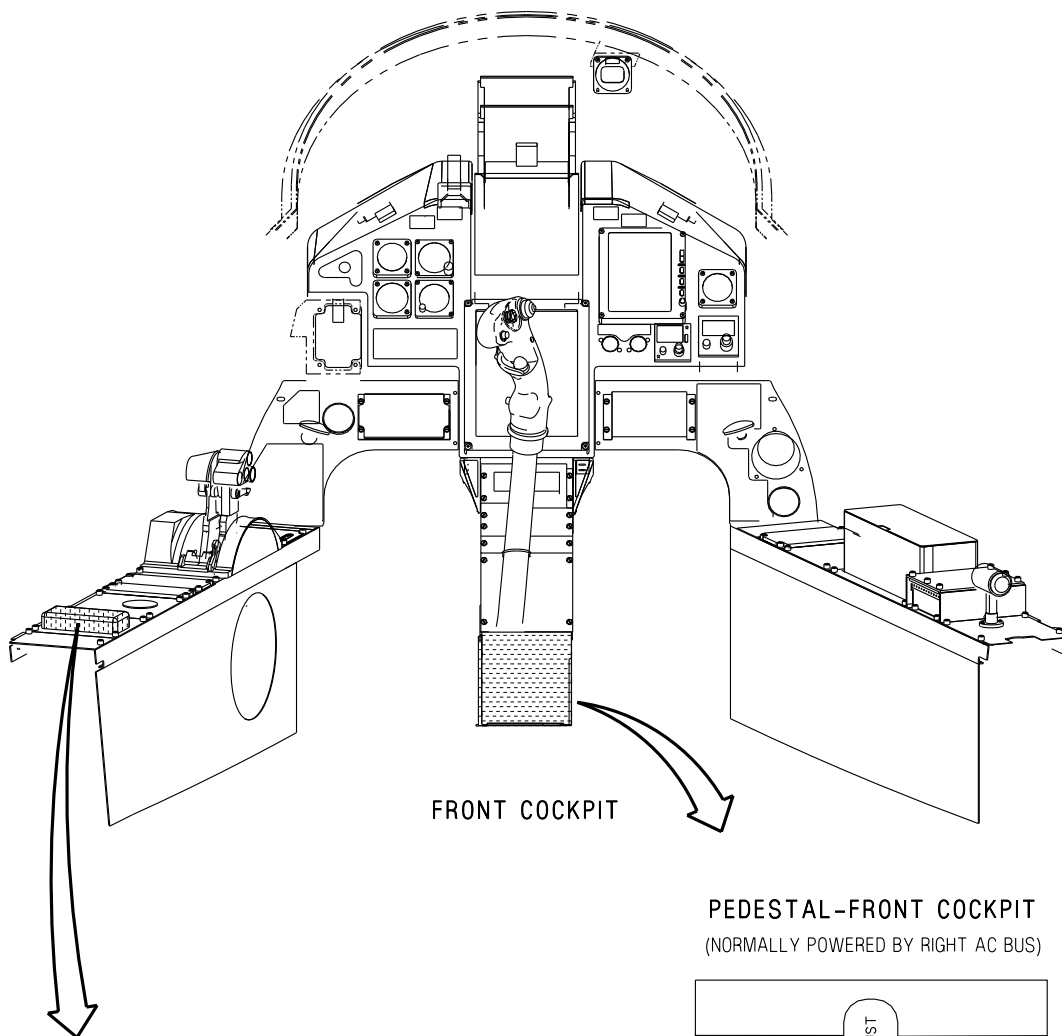

FRONT COCKPIT

LEFT CONSOLE-FRONT COCKPIT

(28-VOLT DC BUS)

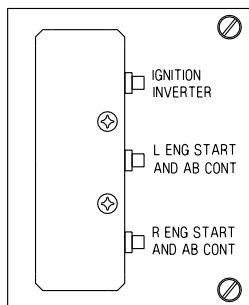

PEDESTAL-FRONT COCKPIT

(NORMALLY POWERED BY RIGHT AC BUS)

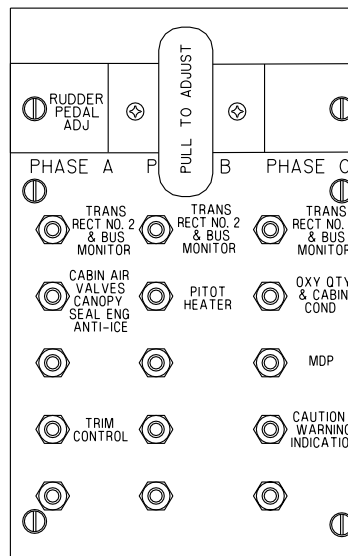
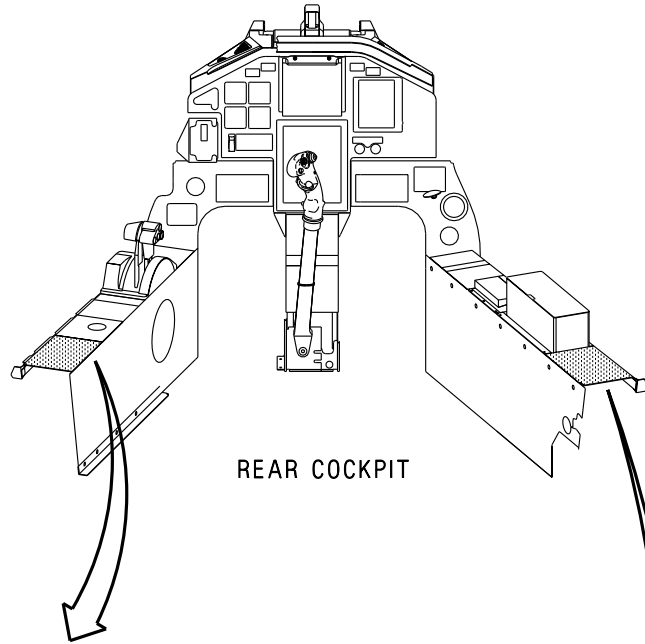

Figure 1-25. Electrical System (Sheet 4)

CIRCUIT BREAKER PANELS



REAR COCKPIT

LEFT CONSOLE-REAR COCKPIT
(NORMALLY POWERED BY LEFT AC BUS)

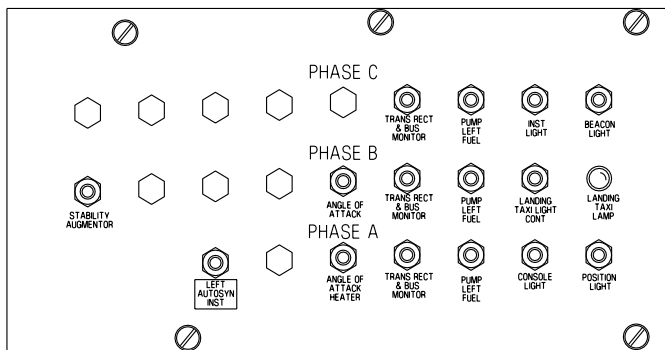

RIGHT CONSOLE-REAR COCKPIT
(NORMALLY POWERED BY RIGHT AC BUS)

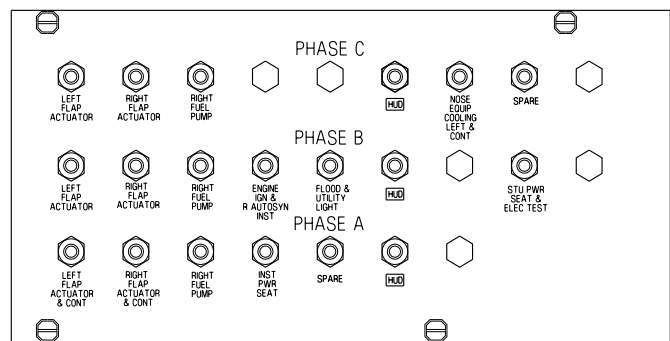

Figure 1-25. Electrical System (Sheet 5)

T38002-7-3-020

CIRCUIT BREAKER PANELS

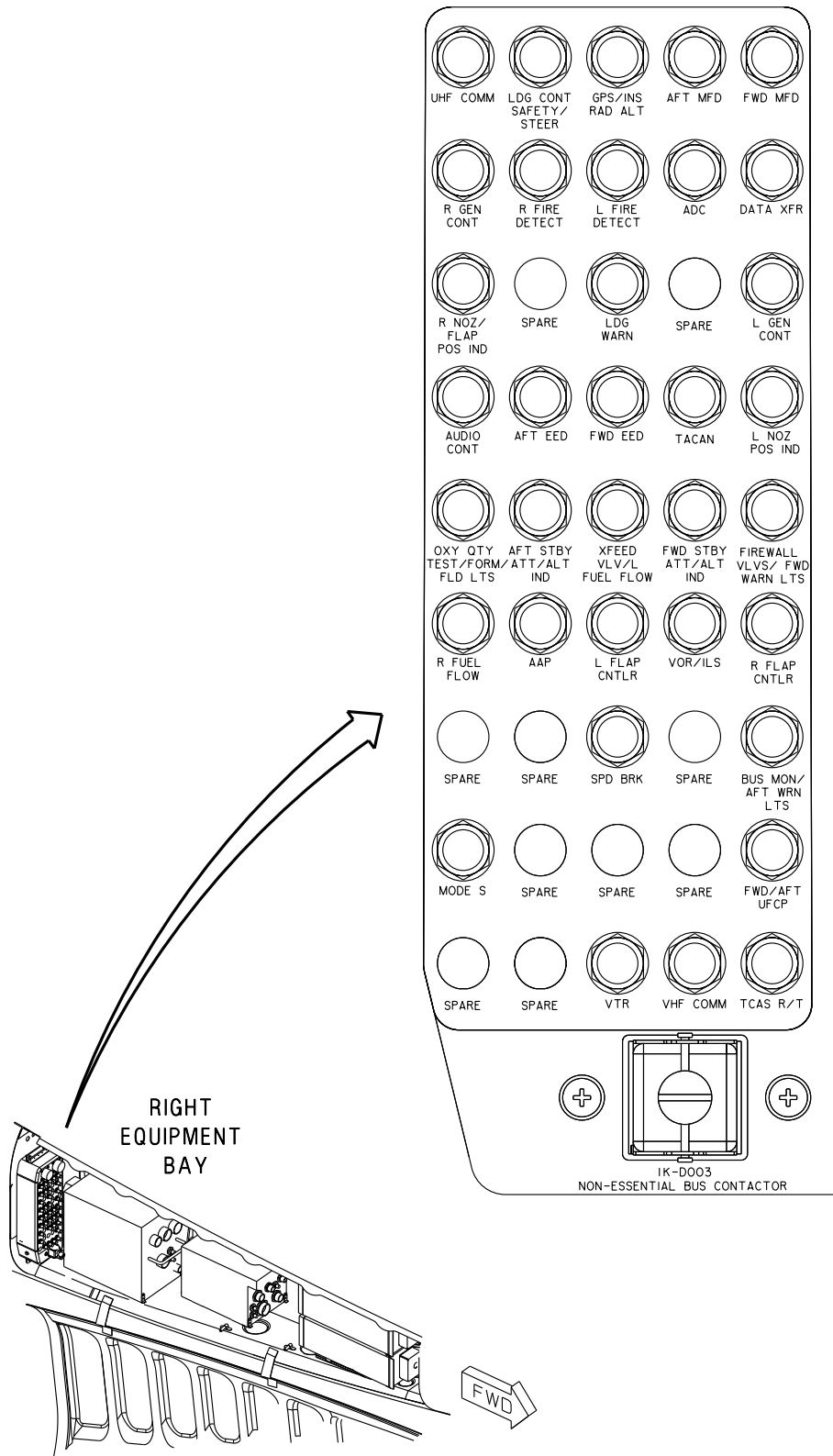

Figure 1-25. Electrical System (Sheet 6)

HYDRAULIC SYSTEMS

The aircraft hydraulic power supply systems (Figure 1-26) include the 3000 PSI utility system powered by the left engine and the 3000 PSI flight control system powered by the right engine. Under normal circumstances there is no interchange between systems. Separate pressure indicators and caution lights are provided for each system. See Figure 1-281 SERVICING DIAGRAM for hydraulic fluid specification.

HYDRAULIC PRESSURE INDICATORS

Two AC powered hydraulic pressure indicators, one for each hydraulic system (placarded UTILITY HYD PRESS and FLT CONT HYD PRESS), are located on the right side of the instrument panel below the EED in each cockpit.

HYDRAULIC CAUTION LIGHTS

A caution light for the utility and flight control hydraulic systems, placarded UTILITY HYDRAULIC and FLIGHT HYDRAULIC respectively, is

located on the Caution Light Panel in each cockpit. The lights illuminate for the following reasons:

- a. Low pressure condition: Hydraulic pressure approximately 1500 PSI and below detected.
- b. Fluid over temperature: Excessively high fluid temperatures detected.

The caution lights go out when hydraulic pressure is restored to approximately 1800 PSI or when the hydraulic fluid temperature cools down below overheat threshold conditions. The hydraulic pressure indicators must be observed to determine which condition has caused the lights to illuminate.

**T.O. 1T-38C-1
HYDRAULICS**

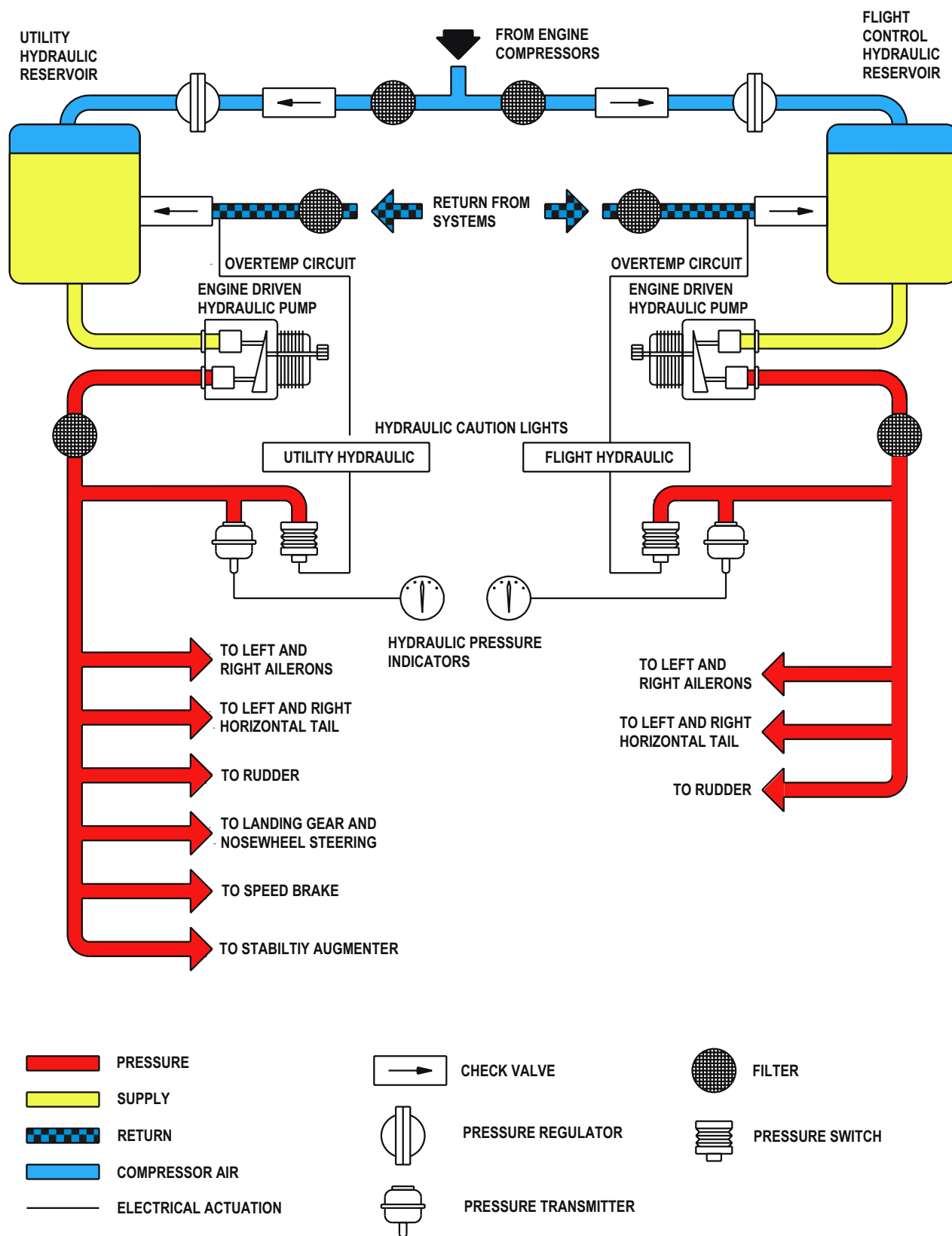

Figure 1-26. Hydraulic Systems

T38002-8-1-020

LANDING GEAR SYSTEM

LANDING GEAR CONTROLS

LANDING GEAR LEVER

A landing gear lever is located on the instrument panel of each cockpit. The two levers are mechanically interconnected. Extension and retraction of the landing gear and gear doors are powered by the utility hydraulic system and electrically (DC) controlled by the landing gear levers. Landing gear extension or retraction normally takes approximately 6 seconds. The normal landing gear cycle can be reversed at any time. The normal extension sequence is doors open, gear extends, doors close. The retraction sequence is doors open, gear retracts, doors close.



The front cockpit pilot should not place the left foot outboard of the rudder pedal due to the possibility of striking the landing gear handle interconnect linkage causing unintentional landing gear extension or retraction.

LANDING GEAR WARNING SYSTEM

The landing gear warning system consists of an MDP-generated gear warning tone, (audible through the headset in both cockpits), a flashing GEAR warning display in the HUD and MFD Message Windows, and a red light within the wheel-shaped end of each cockpits landing gear lever. These items are simultaneously activated if the landing gear is not down and locked and all the following conditions exist:

- a. The airspeed is 210 KCAS or less.
- b. The altitude is 10,000 feet or below.
- c. Both throttles are below 96 % RPM.

NOTE

Power required under single engine conditions may be in excess of that required to activate the landing gear warning system.

During landing gear extension with the landing gear warning system activated (landing gear lever in LG DN position), the gear lever light goes out when all

three landing gear are down and locked. The warning tone goes silent and the HUD/MFD flashing GEAR warnings are removed when the nose gear is down and locked. If the nose gear extends and locks faster than the main gear, the tone can go silent and the HUD/MFD flashing GEAR warnings can be removed before the red light in the gear lever goes out.

During landing gear retraction (landing gear lever in the LG UP position), the red light in the landing gear lever does not extinguish until all three gear doors are closed. With the gear handle in the LG UP position and the landing gear warning system not activated, a red light in the landing gear lever indicates that the landing gear doors are not up and locked. The audible warning signal is not activated by an unlocked gear door condition.

With the system activated and the airspeed increasing, the red light in the landing gear lever and audible tone may not go off until aircraft speed reaches 240 KCAS.

LANDING GEAR WARNING SYSTEM SILENCE BUTTON

A landing gear WARNING SILENCE button is located on the instrument panel next to the landing gear lever in each cockpit. Pressing either button silences the audible landing gear warning tone in both headsets.

LANDING GEAR LEVER DOWNLOCK OVERRIDE BUTTON

A landing gear lever DOWNLOCK OVERRIDE button on the instrument panel next to the landing gear lever in each cockpit enables either aircrew to raise the landing gear lever to the LG UP position if the locking solenoid fails to release the landing gear lever from the LG DOWN position. With the button pressed, the landing gear lever can be raised to the LG UP position during flight or on the ground. The RCP DOWNLOCK OVERRIDE button operates electrically; the FCP DOWNLOCK OVERRIDE button operates mechanically.

LANDING GEAR POSITION INDICATOR LIGHTS

Three green landing gear position indicator lights on each instrument panel above the landing gear lever

T.O. 1T-38C-1

LDG GEAR

illuminate when the gear is down and locked. Each light has a press to test function and should illuminate when pressed.



Cross threading of the light assembly could result in the light sticking in the press to test position after pressure is removed, giving an erroneous green light. When pressing to test, the aircrew must ensure that the light is spring loaded to the out position.

NOTE

- There are separate contacts on the landing gear down lock switches for each cockpit green light indicator. A good light in either cockpit assures that gear is down and locked.
- With DC failure, the rear cockpit nose gear light does not illuminate due to gear relay wiring.
- In the event of RCP nose gear indication circuitry failure to the MDP; the STALL warning is not available (refer to Warning/Caution/Advisory (WCA) System, this section), gear down symbology on the HUD is not displayed (Refer to F-16 HUD Gear Down Symbols, this section and MIL-STD HUD Gear Down Symbols, this section), and the MDP automatic speed calculation is disabled.

Landing Gear Down Alternate Release Handle

A LANDING GEAR DOWN alternate release handle on the left sub-panel of the FCP permits gear extension without hydraulic pressure or electrical power. When the handle is pulled, the normal landing gear hydraulic and electrical systems are deenergized, and the gear uplocks and gear door locks are mechanically released, permitting the gear to extend by its own weight. No portion of the landing gear structure is under hydraulic pressure after extension by the alternate system. The handle must be held in the fully extended position (approximately 10 inches) until all three gears are unlocked. Extension of the main and nose landing gear requires approximately 15 seconds,

but can take up to 35 seconds. If gear alternate extension was accomplished with the gear lever in LG UP, the lever must be placed at LG DOWN and then returned to LG UP to reactivate the normal system. After an alternate extension, the main gear doors remain open and nosewheel steering is not available until the system is reactivated. The nosewheel door assumes a spring-loaded closed position after alternate extension. The landing gear reset lever, located outboard of the left rudder pedal in the FCP can be used to reset the landing gear switches.

NOTE

- During preflight, if the striker plate in the nose gear well is found in the extended position, check the reset lever in the reset (UP) position. This resets all gear switches, but does not raise the striker plate. The striker plate remains extended until the nose gear retracts after takeoff.
- Some landing gear malfunctions can be fixed by ensuring the lever is in the reset (UP) position.
- If the gear is lowered by the alternate release handle with the landing gear in the LG UP position, the red light in the landing gear lever remains illuminated. In this situation, the illuminated red light indicates the gear door open condition normally associated with the gear retraction cycle. The landing gear green indicator lights illuminate and the warning tone is silent, indicating a positive gear down and locked condition.

LANDING GEAR DOOR SWITCH

A guarded switch, placarded LG DOOR, is provided on the left console of the FCP. With electrical and hydraulic power available, this switch permits opening and closing the landing gear doors when the landing gear lever is in the LG DOWN position. If the gear is extended in flight with the gear door switch in OPEN, the gear doors remain open until the gear is retracted or the landing gear door switch is placed in NORM.

WEIGHT OFF WHEELS/LDG UP SWITCH

A WEIGHT OFF WHEELS/LDG UP switch, installed in the rear cockpit, left console, simulates weight-off-wheels. It is for maintenance use only.

NOSEWHEEL STEERING (NWS) SYSTEM

The NWS system provides directional control and shimmy damping. Hydraulic pressure for the system is supplied by the utility hydraulic system. Nosewheel steering is controlled by rudder pedal action and may be activated only when aircraft weight is on the nosewheel and the NWS Switch is held in the pressed position. If the nosewheel position does not correspond to the position of the rudder pedals when steering is activated, the nosewheel turns to correspond to the rudder pedal position.

NWS SWITCH

NWS is electrically (DC) activated by the NWS Switch on the control stick in either cockpit. See Figure 1-27 in the Flight Control System Section. With the switch pressed, nosewheel steering is deactivated while one or both throttles are advanced to MAX range. Whenever the aircraft weight is not on the nose gear, the system automatically deactivates. With weight-off-wheels, the NWS Switch provides additional functionality; refer to HANDS ON THROTTLE AND STICK (HOTAS), this section.

NOSEWHEEL CENTERING MECHANISM

A nosewheel centering cam mechanically streamlines the nosewheel whenever the nose gear strut is fully

extended. Air pressure in the strut mechanism ensures that the nose gear strut remains fully extended during gear retraction.

WHEEL BRAKE SYSTEM

The main gear wheel brakes are the segmented rotor type and are powered by a separate, completely self-contained hydraulic system. Three brake self-adjuster mechanisms are installed on the wheel brake assembly. These self-adjusters have a nut running through the middle of a cylinder.

NOTE

- The brake discs and plates are near the end of their service life when the top of the nut is less than flush with the top of the cylinder on any of the three mechanisms.
- Pilots should have maintenance personnel check the brakes for excessive wear with a gauge any time the brake self-adjuster nut is less than flush with the rim of the cylinder.

The brake pedals are the conventional toe-operated type. Each brake pedal controls a hydraulic master cylinder. Control of the brakes transfers to the crewmember applying the greater pedal force.

FLIGHT CONTROL SYSTEM

FLIGHT CONTROL SYSTEM OVERVIEW

A hydraulically powered, irreversible flight control system is provided. Airloads on the control surfaces cannot cause control stick or surface movement. Conventional aerodynamic feel in the control stick is provided artificially by springs and bob weights. The springs progressively resist control stick displacement and the bob weight mechanism further resists aft stick travel during maneuvering flight. The rudder control system contains a force producer spring which provides artificial feel and centering for the rudder system. Lateral and longitudinal trim is provided by electrical motors which change the neutral reference point of the feel springs and control stick position.

Each control surface is moved by two hydraulic cylinders; one is powered by the utility system, the other by the flight hydraulic system.

CONTROL STICK

Each cockpit has a control stick grip, Figure 1-27, which contains a Weapon Release (Pickle) button, Master Mode Switch (MMS), Trigger, Default Display Switch (DDS), NWS Switch and the Trim button. For information on the Weapon Release button, MMS, Trigger, DDS, and NWS, refer to HANDS ON THROTTLE AND STICK (HOTAS), this section.

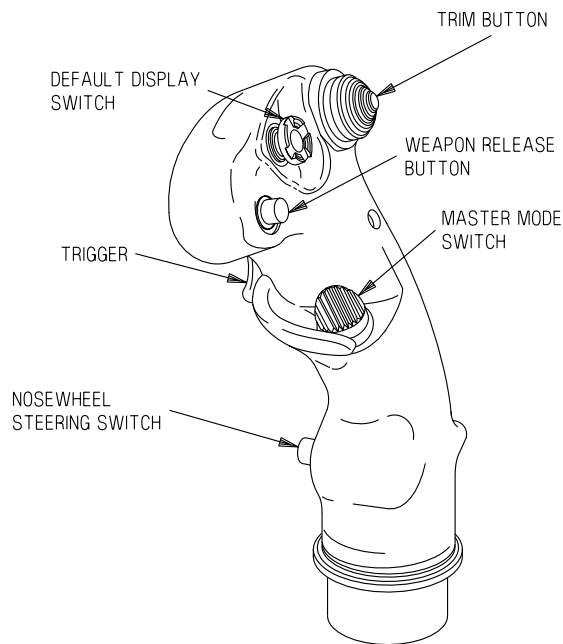

Figure 1-27. Stick Grip

T38002-218-1-020

RUDDER SYSTEM

RUDDER PEDAL ADJUSTMENT T-HANDLE

A mechanical rudder pedal adjustment T-handle is located on the pedestal of each cockpit. To adjust rudder pedals, pull the T-handle out and hold until pedals are repositioned. Return the T-handle to the stowed position manually to lock the pedals in place.



Allowing the handle to snap back may trip or damage pedestal circuit breakers and cause the cable to kink and wear excessively.

RUDDER LIMITER

Deflection of the rudder is limited by a mechanical linkage between the rudder control system and the nose gear trunnion. When the nose gear is extended $\frac{3}{4}$ or less, rudder deflection is limited to 6° from neutral in either direction. When the nose gear is more than $\frac{3}{4}$ extended, full rudder deflection of 30° from neutral in either direction is available. The rudder limiter cannot be overcome by either crew-member.

YAW STABILITY AUGMENTOR SYSTEM (YSAS)

The Yaw Stability Augmentor System uses utility hydraulic pressure to position the rudder to reduce yaw oscillations. The YSAS is turned on and off via the EGI power switch on the AAP. Manual rudder trim is accomplished through the yaw damper contained within the EGI. Refer to EMBEDDED GLOBAL POSITIONING SYSTEM (GPS)/INERTIAL NAVIGATION SYSTEM (INS) (EGI), this section

A yaw damper switch, placarded DAMPER is located on the left console of the front cockpit. The switch is spring-loaded to OFF and is held in the YAW position by AC power. The yaw damper is disengaged by returning the switch to OFF. The augmentor disengages automatically in the event of AC power failure, transferring ICAO data from the Data Transfer System (DTS) to the MDP, and certain system malfunctions. Generator crossover checks can cause YSAS

disengagement. The aircraft can be flown safely throughout the flight envelope without the YSAS engaged.

NOTE

Ground operation of the YSAS can result in chatter of the rudder and rudder pedals 5 to 10 seconds after nosewheel activation following turns during ground taxi operations. Following turn completion, the rudder and rudder pedals can chatter for 1 to 2 seconds

TRIM SYSTEM

A takeoff trim system allows positioning of the horizontal tail for the optimum takeoff setting. The system uses the normal longitudinal trim system along with a TAKE OFF TRIM pushbutton and indicator light installed on the left console in both cockpits. When the button is pushed and held, the trim motor moves the control stick to the appropriate position at which point the motor stops and a green indicator light illuminates on the left console. The aircraft has external markings to visually confirm proper takeoff trim horizontal tail position.

TRIM BUTTON

Operation of the Trim button activates an AC motor, causing appropriate movement of the control stick. Pressing the switch left and right trims the aircraft laterally. Pressing the switch forward and aft trims the aircraft longitudinally.

Limit switches are installed in the system which limit the range of stick travel obtainable through use of the trim system. Cutout switches interrupt horizontal tail trim when stick force is exerted against the direction of trim. These two systems limit the effects of runaway trim, since the aircraft can be flown with the control stick at either of the trim limit cutout positions; however, very heavy stick forces can be encountered.

RUDDER TRIM

An electrical RUDDER TRIM knob on the YSAS Control Panel, (FCP left console) provides the means of trimming the rudder 2° in either direction. The DAMPER switch must be placed in the YAW position before the rudder assumes the selected trim position.

T.O. 1T-38C-1
FLT CONTROLS

The following must be operative for rudder trim and YSAS operation:

- a. LT and RT AC and RT essential DC bus
- b. MDP
- c. EGI

- d. ADC
- e. Utility hydraulic pressure.

Failure in any of these systems will cause YSAS to disengage and loss of rudder trim control.

LIFT AND DRAG DEVICES

FLAP SYSTEM

The primary purpose of the flaps is to provide increased lift for takeoff and landing. The flaps should not be used in high AOA or aerobatic maneuvering. The flaps are electrically (DC) controlled by the flap lever switch, placarded FLAPS, in the front cockpit. The flaps are operated by two AC electric motors and are interconnected by a rotary flexible shaft. If one flap motor fails, both flaps are actuated through the rotary shaft. Flap extension time is much longer than normal with one motor failed.

FLAP-HORIZONTAL TAIL (FLAP-SLAB) INTERCONNECT SYSTEM

Flap operation changes the aerodynamic properties of the aircraft. The flap-slab interconnect system compensates for these aerodynamic changes and maintains essentially the same aircraft handling qualities, regardless of flap position.

To provide the required compensation, the flap position is mechanically transmitted to the horizontal tail operating mechanism through an interconnect cable. The majority of the compensation occurs in the first 35 % of flap deflection. As the flaps are moved, the interconnect system provides the following:

- a. The horizontal tail is automatically repositioned to minimize the pitch changes caused by flap movement.
- b. As the flaps are extended, the interconnect system increases the amount of horizontal tail travel available in the nose down direction.
- c. The interconnect system changes the pitch authority of the control stick by increasing the amount of horizontal tail deflection per inch of stick travel.

If the interconnect system fails with flaps extended, expect the following:

- a. A spring mechanism rapidly removes all flight control compensation and repositions the horizontal tail to the 0 % (UP) flap position.
- b. The aircraft will always pitch-up, and moderate to heavy forward stick forces (probably beyond the forward trim limit) will be required to maintain controlled flight. Greater than normal control stick movements will be required to affect pitch response.

c. When flaps are retracted following an uncommanded pitch-up, the aircraft will have a pronounced tendency to settle and a large aft stick movement will be required to maintain level flight.

d. Normal handling qualities will be obtained only when the flaps are retracted to the up position.

FLAPS LEVER AND POSITION INDICATOR

A FLAPS lever is located on the throttle quadrant of each cockpit. The two levers are mechanically interconnected by cables; however, the lever in the front cockpit actuates the electrical switch that operates the two flap motors. Sensing switches stop the flaps at 60 % when the FLAPS lever is placed in the 60 % detent. When operating in the emergency mode, the flaps can be stopped at any position by placing the FLAPS lever in the 60 % detent. When UP or DN is selected, flap movement is stopped by limit switches at the fully retracted or extended position.

The FLAP Position Indicator, which operates on DC, is located on the left sub-panel of each cockpit. Flap extension is indicated as a percentage of full flap travel.

NOTE

- If the FLAPS lever is between the 0-60 % position or the 60-100 % position the flaps will not extend or retract.
- AOA and Auto Speed Bug calculations are based on flap angle supplied by the ADC to the MDP, not the Flap Position Indicator.

AUXILIARY FLAP CONTROL SWITCH

The two position auxiliary flap control switch, placarded AUX FLAP is located in the front cockpit on the left console. In the normal (NORM) position, flap positions of full up, 60 % down, and full down can be selected. In the emergency (EMER) position, flaps can be set at any selection from full up to full down. In this mode of operation, flap extension or retraction is stopped by moving the lever to the 60 % detent, which then functions as an OFF position, or by limit switches when the flaps have fully extended or retracted.

T.O. 1T-38C-1

LIFT & DRAG

SPEED BRAKE SYSTEM

A DC electrically controlled, hydraulically activated dual surface speed brake is located on the lower surface of the fuselage center section. Design of the activation system permits selection of intermediate speed brake positions other than fully extended.

SPEED BRAKE SWITCH

A three-position DC powered AFT (EXTEND) - CENTER (HOLD) - FORWARD (RETRACT) speed brake switch is installed on the right throttle in each cockpit, Figure 1-46, in Avionics Systems Section. The switch in the FCP has positive detents in each

position. The switch in the RCP can override the position selected in the FCP and is spring-loaded to the center HOLD position. Following override, control of the speed brake system is regained in the FCP by moving the switch to HOLD. Intermediate speed brake positions can be obtained by positioning the switch to the desired direction of movement and then returning to the HOLD position.

Speed brake creep occurs with the switch in the HOLD position. To prevent creep following actuation from the RCP, the FCP switch should be placed in the position selected in the RCP.

PNEUMATIC SYSTEM

PNEUMATIC SYSTEM OVERVIEW

Air taken from the eighth stage compressor is used for hydraulic reservoir and cabin pressurization, air conditioning systems, canopy defogging, engine anti-icing, canopy seal inflation, and anti-g system.

CABIN AIR CONDITIONING AND PRESSURIZATION SYSTEM

CABIN PRESSURE REGULATOR AND INDICATOR

The Cabin Pressure Indicator on the FCP instrument panel indicates the pressure altitude within the cabin. All controls in the air conditioning and pressurization system, except the canopy defog, are electrically (AC) controlled. The canopy defog is pneumatically controlled and does not require AC power. See Figure 1-28 for cabin pressurization schedule. The cabin pressure regulator maintains cabin pressure at relative 0 PSI differential at altitudes below 8000 feet. Between 8000 feet and approximately 23,000 feet, the regulator maintains a cabin pressure corresponding to 8000 (± 1000) feet. Above 23,000 feet, the regulator maintains a pressure differential of 5 PSI above ambient pressure (± 2000).

CABIN PRESSURE SWITCH

A guarded Cabin Pressure Switch (Figure 1-29) is located on the right console of the FCP. The switch controls cabin air conditioning and pressurization. When the switch is placed in CABIN PRESS, both the cabin air conditioning and pressurization systems are activated. When the cabin pressure switch is placed in RAM DUMP, the anti-g suit, canopy defog, cabin pressurization and air-conditioning systems, and canopy seal are deactivated, and ram air enters the cabin for ventilating purposes. Placing the cabin pressure switch in RAM DUMP does not deflate the canopy seal, but prevents air flow into the seal. The seal remains inflated for an undetermined amount of time. Normal seal deflation is provided by a switch

activated by opening the canopy locking lever, provided AC power is available.



Vibrations accompanied by fumes and/or odors from the air conditioning system may indicate air conditioner turbine failure. If this condition is suspected, select oxygen - 100 %, descend below 25,000 feet, and select RAM DUMP to deactivate the air conditioning system. This should stop the vibrations.

NOTE

To eliminate cabin air conditioning duct howl with the RCP cabin air inlet valve closed, adjust either the FCP cabin air inlet valve toward the closed position or adjust the RCP cabin air inlet valve toward the open position.

CABIN TEMPERATURE (TEMP)

The CABIN TEMP Switch (Figure 1-29) is a four-position switch. With the Cabin Pressure Switch in CABIN PRESS, cabin temperature may be controlled in 2 ways:

- a. CABIN TEMP Switch - AUTO. Cabin temperature is controlled using the CABIN TEMP Rheostat.
- b. CABIN TEMP Switch - neutral. The spring-loaded MAN HOT and MAN COLD positions provide for manual temperature control.

NOTE

When controlling temperature manually, momentarily stop the switch at the neutral position.

CANOPY DEFOG KNOB

The volume of flow of defog air to the windshield and both canopies is controlled by the CANOPY DEFOG rheostat in the FCP, Figure 1-29.

T.O. 1T-38C-1 PNEUMATICS

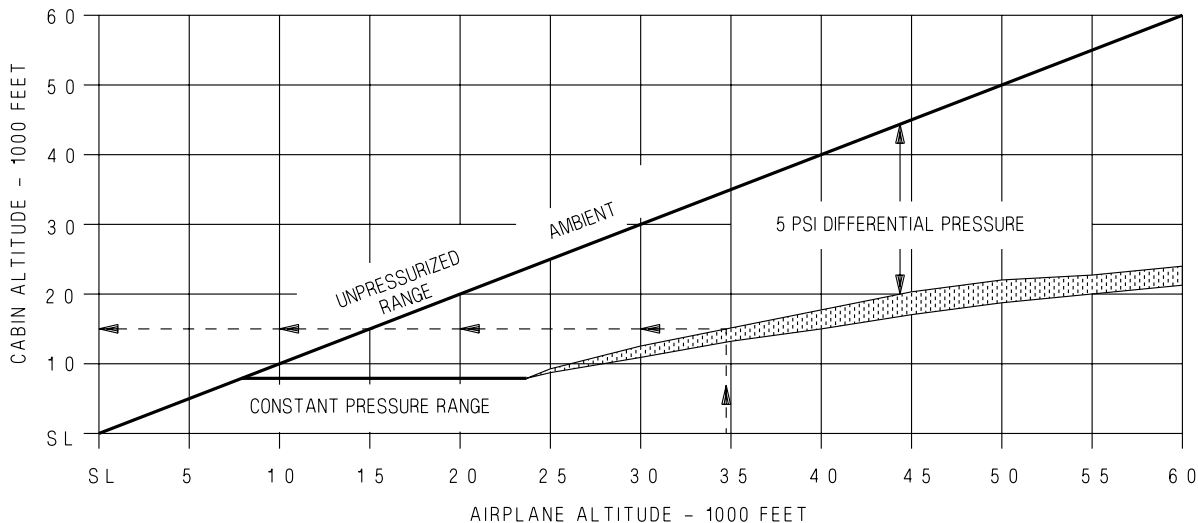

EXAMPLE - REFER TO DASHED LINE
 AIRCRAFT ALTITUDE OF 35,000 FEET EQUALS
 COCKPIT ALTITUDE OF 14,500±2,000 FEET.

T38002-25-1-020

Figure 1-28. Cabin Pressurization Schedule

ANTI-G SUIT SYSTEM

Air pressure from the air conditioning system is used to inflate the anti-g suit in each cockpit to offset the effects of high load factor.

ANTI-G VALVE

An anti-g suit press-to-test button placarded ANTI-G VALVE in the top of each regulator is located on the left console of each cockpit. The button is used to manually test operation of the anti-g suit valve; the further the button is pressed, the greater the anti-g suit pressure available.

ENGINE ANTI-ICE SYSTEM

Engine anti-icing is accomplished by directing compressor eighth-stage air to the inlet guide vanes and bullet nose of the engine. A shutoff valve (normally closed) is controlled electrically by a three-position ENG ANTI-ICE Switch, Figure 1-29, on the right console of the FCP. The switch positions are placarded MAN ON in the up and MAN OFF in the center and down positions. Placing the switch in MAN ON allows hot air to flow to the inlet guides vanes and bullet nose of the engine and causes the ENG ANTI-ICE ON light on the Caution Light Panel

and the MASTER CAUTION light in each cockpit to illuminate. The caution light alerts the aircrew that the switch is in the MAN ON position but does not indicate that the system is operating. At engine speeds of 94-98 % RPM, an increase in EGT of approximately 15°C is normal with the switch in MAN ON.

The engine anti-ice system fails to the ON position with a complete loss of AC electrical power. Below 65 % RPM, the anti-ice valve is always open, allowing hot air to flow to the inlet guide vanes and bullet nose of the engine, regardless of the position of the ENG ANTI-ICE Switch.

The switch should normally be at MAN OFF as a loss of thrust (180 ±10 pounds) can be expected with the ENG ANTI-ICE Switch ON. This is approximately a 9 % loss in MIL and a 6.5 % loss in MAX for non-PMP aircraft and an 8.5 % in MIL and a 5.5 % loss in MAX for PMP aircraft.

AOA VANE ANTI-ICING

The AOA transmitter vane is deiced by an electric heating element powered by the left AC bus and activated when the PITOT HEAT switch is turned on.

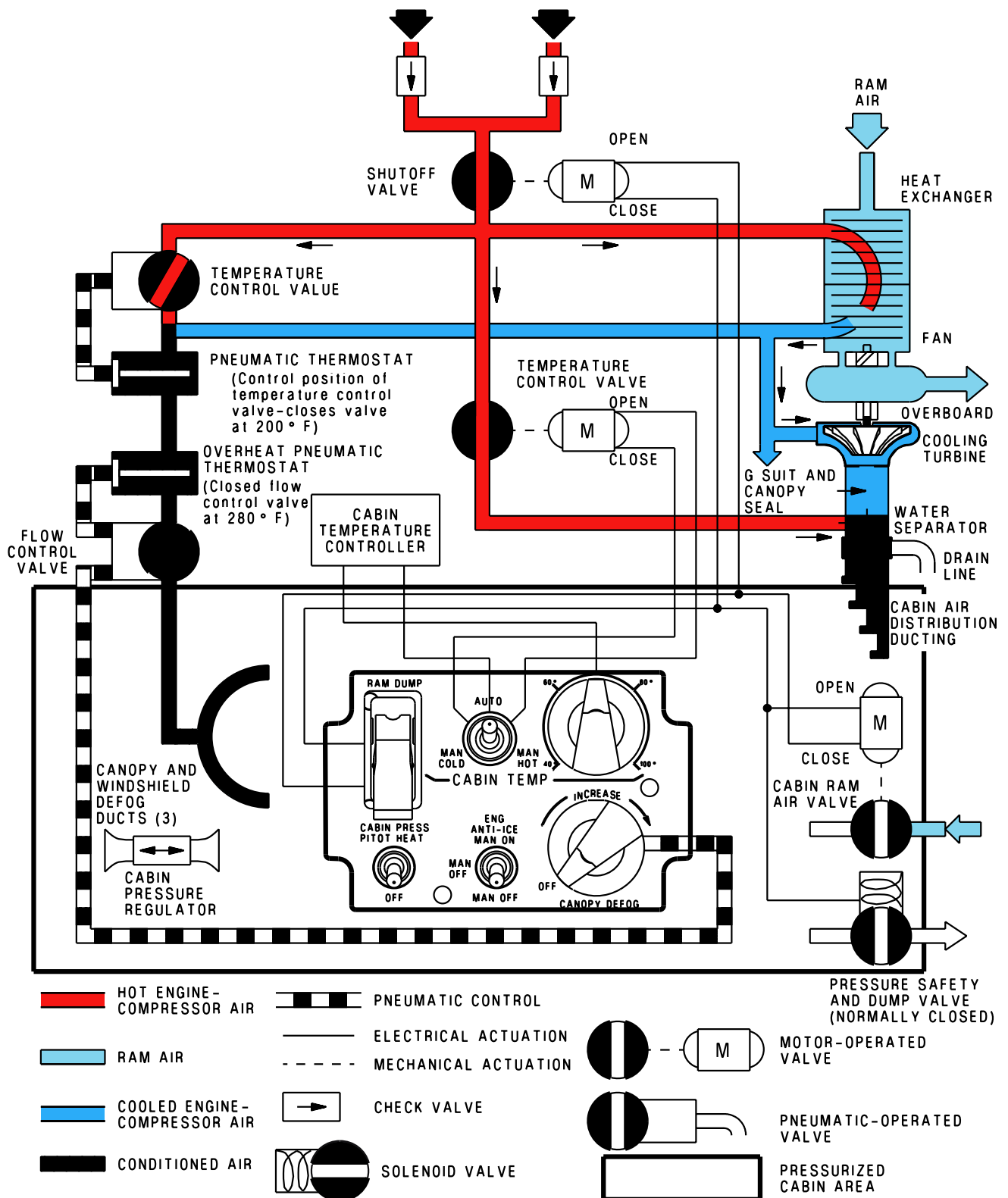

T38002-24-1-021

Figure 1-29. Cabin Air Conditioning and Pressurization System

PITOT-STATIC SYSTEM

PITOT-STATIC SYSTEM OVERVIEW

The pitot-static system supplies both impact and static air pressure to the Air Data Computer (ADC) and the Standby Instruments. The ADC also provides signals to the landing gear warning circuits. The Standby Altimeter and Standby Vertical Velocity Indicator receive only static pressure from the system.

PITOT BOOM ANTI-ICING

The pitot boom is de-iced by an AC electrical heating system. The heater is controlled by the Pitot Heat Switch located on the right console in the FCP. See Figure 1-29 in the Pneumatics Section. Placing the switch to PITOT HEAT applies power to the pitot boom heater, the AOA transmitter vane heater, and the total air temperature (TAT) probe heater.

NOTE

The following cockpit indications can occur when pitot heat operations on the ground exceed 30 seconds.

a. YSAS can disengage and not reengage unless sufficient cooling airflow is generated (25 knots) or pitot heat is turned off and it cools sufficiently.

b. Due to vibration of the AOA vane transmitter heating element, an ADC PFL can be generated and all three AOA indexer lights can illuminate

c. TAS is not available for display.

TAT PROBE

The TAT probe provides information to the ADC. The TAT Probe has a temperature range of $\pm 60^{\circ}\text{C}$.

ANGLE OF ATTACK (AOA) SYSTEM

AOA SYSTEM OVERVIEW

The AOA system (Figure 1-30) senses aircraft angle of attack and displays this information to both crewmembers. The AOA system consists of an AOA Vane Transmitter, an AOA indicator on both MFDs and HUD, an AOA Indexer and an INDEXER LIGHTS Dimmer Control. AOA display information is driven by the AOA function in the ADC.

The system provides compensation for various flap and landing gear configurations. The AOA system presents the following displays in each cockpit:

- a. Approximate AOA for maximum range and maximum endurance.
- b. Optimum AOA for final approach.
- c. AOA when approach to stall buffet and stall will occur.

The AOA Transmitter vane is located on the forward right side of the fuselage. The vane is electrically heated for anti-ice and is activated when the Pitot Heat Switch is placed in the PITOT HEAT position. The ADC, (powered by the right essential 28 VDC bus), receives signals from the AOA transmitter vane, Flap Position synchro-transmitter, and nose gear downlock indicating system. The AOA Transmitter vane and Flap Position synchro-transmitter outputs are powered by the left AC bus. The ADC computes and sends the appropriate signals to the MDP for the MFD PFR AOA indication and to the AOA Indexer Lights in each cockpit.

If the ADC detects either the AOA Transmitter or Flap Position synchro-transmitter outputs are out of tolerance or missing, the ADC will trigger an ADC FAIL PFL. A flashing AVIONICS will also be displayed in the MFD and HUD Message Windows. The digital AOA Display and AOA Pointer on the MFD AOA Indicator are removed, the AOA Indexer lights illuminate and the Current AOA display is removed from the HUD. Air Speed and Altitude remain valid on the MFD and HUD.

AOA INDICATOR DISPLAY

The AOA indicator on the MFD operates during all phases of flight and indicates AOA information. For

MFD AOA Indicator display description, refer to MFD Displays, this section.

WARNING

The airspeed indicator should be cross-checked frequently when using AOA information.

AOA INDEXER

The ARU-27/A AOA Indexer above the instrument panel is controlled by the AOA function of the ADC and provides an illuminated head up display of the AOA information in the form of low speed, on speed, and high speed indexer lights, Figure 1-30. The three indexer lights are powered by the left essential 28 VDC bus. With the landing gear and flaps up, the high-speed indexer light is inoperative to eliminate continuous illumination during cruise flight conditions.

An AOA system or ADC failure is indicated when all three lights of the indexer are illuminated. The three indexer lights can be tested by placing the WARNING TEST switch on the right console to TEST. If the ADC detects any light bulb failures in either cockpits AOA Indexer, the ADC will trigger an ADC FAIL PFL. A flashing AVIONICS will also be displayed in the MFD and HUD Message Windows.

NOTE

An AOA heat monitor failure can cause all three indexer lights to come on simultaneously. This condition can occur on the ground during taxi with the Pitot Heat Switch in the PITOT HEAT position. No maintenance action is required unless the indexer lights remain on for more than 2 consecutive minutes. A failure in the AOA heater while airborne will illuminate all three indexer lights.

T.O. 1T-38C-1
AOA SYSTEM

AOA INDEXER LIGHTS DIMMER CONTROL

The AOA INDEXER LIGHTS Dimmer Control, Figure 1-30, located on the left side of the instrument panel controls the light intensity of the three indexer lights from dim to bright.

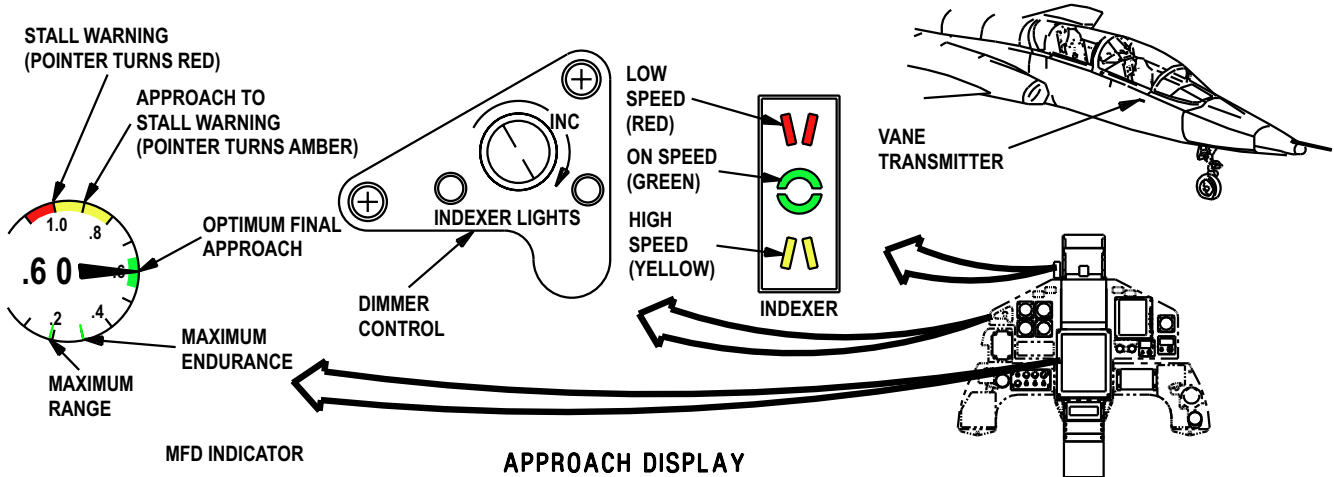

INDICATOR	INDEXER	AOA/AIRPEED	F-16 HUD SYMBOLOGY	MIL-STD HUD SYMBOLOGY
		VERY HIGH AOA SLOW 		
		HIGH AOA SLIGHTLY SLOW 		
		OPTIMUM AOA ON SPEED 		
		LOW AOA SLIGHTLY FAST 		
		VERY LOW AOA FAST 		

Figure 1-30. AOA System and Displays

T38002-27-1-020

CANOPY

CANOPY OPERATION

Each cockpit contains a manually operated clamshell type canopy. The canopy is locked closed or unlocked by a locking lever in each cockpit, or by locking handles outside the left side of the FCP (Figure 1-31).

WARNING

Ensure fingers are clear of canopy lock/unlock handle and aircraft bulkhead as they can become pinched between the handle on the canopy locking lever and the map light on the instrument panel.

Each canopy is counterbalanced throughout its travel limits. The canopy opening mechanism is protected against excessive loads by a hydraulic canopy damper, which also restricts canopy opening and closing speeds. An inflatable pressurization seal installed on each canopy is inflated when both canopies are locked, the Cabin Pressure Switch is in the CABIN PRESS position, and an engine is operating.

WARNING

Loss of canopy and severe injury can occur if either canopy is unlocked prior to depressurizing to field elevation. The canopy could blow off its hinges and fall into the cockpit area. Anytime the aircraft has been pressurized, RAM DUMP must be selected and the cabin pressure checked prior to opening the canopy.

CAUTION

After placing the Cabin Pressure Switch to RAM DUMP, ensure the Cabin Pressure Indicator displays field elevation before operating the canopy. Pressure equalization can take several seconds.

Tests have shown that a bird strike on the windscreen centerline at 400 knots can deform the windscreen enough to impact the HUD, shattering the combining glass, causing glass to spray through the FCP.

WARNING

To avoid injury in the event of a bird strike, helmet visors should be down at all appropriate altitudes.

CAUTION

- Canopy movement from the full open or closed and locked position must be initiated by the external or internal locking handle. Actual raising or lowering of the canopy must be done by hand pressure on the canopy frame. Do not apply pressure on the locking handle to raise or lower the canopy as damage to the mechanism can result.
- The canopy hinge disconnect rods located near the canopy hinge attachment points on each canopy are painted red. Tampering with these rods, using them as handholds or to initiate canopy closure, can release the canopy. Any difficulty encountered when closing the canopy may indicate damaged rods or canopy latch hinge disconnected. Attempts to force the canopy closed can result in subsequent canopy loss.
- If possible, avoid opening the canopy when relative wind (ground speed plus wind component over the nose) exceeds 30 knots. If the canopy must be opened during this condition, use extreme caution to guard against rapid canopy fly up (secure canopy with left hand while in transit).



- If an open canopy has been exposed to high wind or jet blast, it should be checked for normal operation, i.e., fully closed before taxi. If the canopy does not close, the aircraft should not be taxied or towed until cleared by qualified maintenance personnel. Aircraft movement can result in canopy separation.
- Damage and possible loss of canopy can occur if the instrument hood is bunched between the drogue chute housing and canopy, and the seat is raised to the near full up position.
- If the canopy is closed with the shoulder harness on the drogue chute housing, damage to the seat or canopy can occur.

CANOPY WARNING LIGHT

A canopy warning light, placarded CANOPY, Figure 1-31, operating on DC (bright) or AC (dim), is located on the instrument panel of each cockpit. When either canopy is unlocked, both canopy warning lights illuminate.

CANOPY JETTISON SYSTEM

The canopy jettison system permits jettisoning each canopy individually from inside the cockpit or both canopies from outside the cockpit. From inside the

cockpit, the canopy of the respective cockpit can be jettisoned independent of seat ejection by pulling the CANOPY JETTISON T-handle, Figure 1-31 on the right sub-panel of each cockpit. A safety pin is provided for each CANOPY JETTISON T-handle to prevent unintentional jettison of the canopy. A spring clip on the bottom of the CANOPY JETTISON T-handle must be overcome to pull the T-handle out.

To jettison the canopies from outside the cockpit, a canopy jettison D-handle is located externally on each side of the FCP, pointed out by the RESCUE decal. Opening either access door and pulling the D-handle jettisons both canopies. The front canopy jettisons first when the D-handle is pulled, followed 1 second later by jettison of the rear canopy. The canopy jettison system functions properly only with the canopy closed and locked. With the aircraft at rest, the canopy may not separate from the hinges if the canopy is in the fully open position. If the jettison system is activated with the canopy in a position other than fully open, the canopy moves to the full open position and probably will separate from the aircraft.



If the canopy jettison is activated with the canopy in other than the closed and locked position, the canopy could fall off its hinges and into the cockpit area.

**T.O. 1T-38C-1
CANOPY**

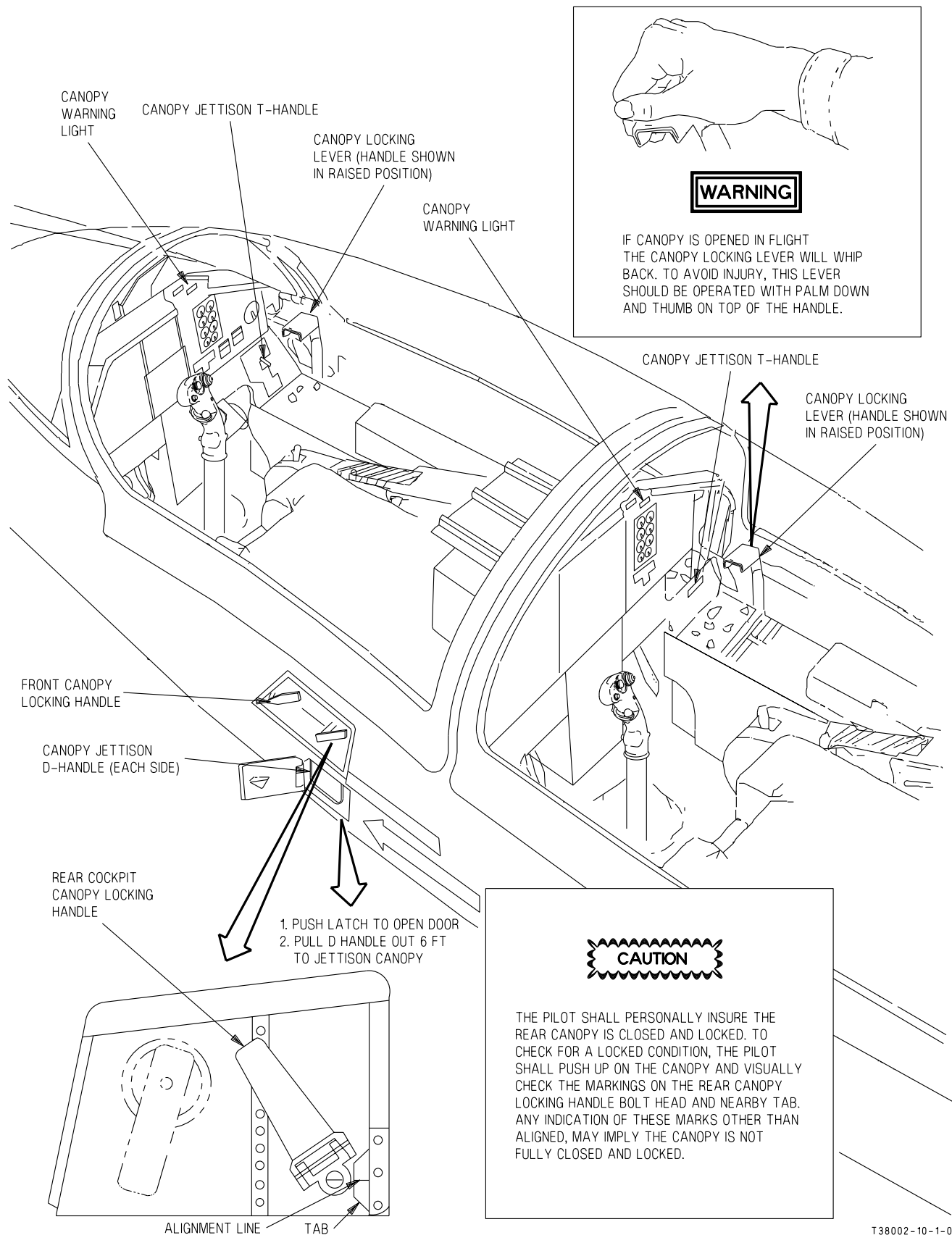
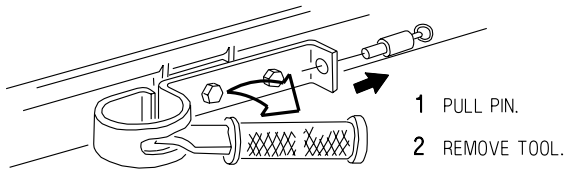
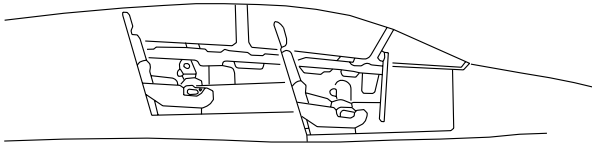

Figure 1-31. Canopy

CANOPY BREAKER TOOL

The canopy breaker tool, Figure 1-32, is stowed on the left canopy frame in each cockpit. The tool is used to break the canopy glass if other methods of opening the canopy fail.



3 USE BOTH HANDS ON HANDLE TO BREAK CANOPY WITH POINT OF TOOL.

T38002-16-1-020

Figure 1-32. Canopy Breaker Tool

EJECTION SYSTEM (BEFORE T.O. 1T-38C-546)

The ejection system consists of an ejection seat with drogue chute and man-seat separator (Figure 1-33), an automatic opening safety belt with 0.65-second delay initiator (Figure 1-35), an automatic opening parachute with 0.25-second delay initiator or zero delay lanyard parachute with a 1-second delay initiator, and an optional survival kit with an automatic 4 second delay initiator or manual deployment capability.

After ejection from the aircraft, the drogue chute deploys to stabilize the seat, the safety belt opens and actuates the man-seat separator forcing the crewmember from the seat. An aneroid delays parachute opening until between 15,000 and 11,500 feet pressure altitude when free falling. At or below this block altitude, parachute opening is initiated at 0.25 second (or 1 second) after seat separation. Low altitude capability (below 2000 feet Above Ground Level (AGL)) is provided by the 0.25-second delay initiator. During parachute deployment, the parachute shroud lines pull the optional survival kit auto/release cable and release the kit with a 4 second delay in AUTO mode. MANUAL mode requires the pilot to pull the canopy release handle for deployment.

EJECTION SEAT

Each cockpit is equipped with a rocket catapult ejection seat (Figure 1-33). A calf-guard, hinged to the forward end of each seat, is pulled downward behind the crewmember's legs during ejection to prevent the crewmember's legs from being thrust backward beneath the seat by wind blast and to assist in man-seat separation. The handgrips initiate the ejection sequence. The single motion of raising either or both handgrips fires the powered inertia reel and initiates the ejection sequence. During the first part of seat ejection, initial seat movement simultaneously disconnects the oxygen, anti-g suit, and communication disconnects, pulls the calf-guard down, fires the safety belt delay initiator, disconnects the seat adjuster power cable and initiates drogue gun operation. Each seat is equipped with a canopy piercer and ejects through the canopy if canopy jettison malfunction is experienced. The front seat canopy piercer is attached to the seat and is raised and lowered with the seat. The rear seat canopy piercer is not attached to the seat and remains in a fixed position when the seat is raised and lowered.

LEG BRACES

Two legbraces, terminating in handgrips, are attached to the ejection seat (one on each side) and are linked together mechanically so that they rise simultaneously. Initial movement of either handgrip releases the downlock on both legbraces. When actuated, the legbraces are held in the raised position by an uplock and cannot be returned to the down stowed position by the crewmember.

EJECTION SEAT SAFETY PIN

The safety pin, when inserted, holds the right leg brace handgrip down, preventing inadvertent seat ejection. The streamer for the ejection seat safety pin is attached to the streamer for the canopy jettison T-handle safety pin.

HANDGRIPS

The handgrips are stowed in the down position when the legbraces are down. When the handgrips are raised fully up and locked, the powered inertia reel retracts and locks and the canopy is jettisoned followed in 0.3 second by seat ejection.

SEAT ADJUSTMENT SWITCH

A seat adjustment switch on the right legbrace provides control of seat adjustment through a vertical range of 5 inches. The adjustment switches operate on AC.



Hard items stored under the seat can puncture the cockpit floor when the seat is lowered resulting in the loss of cabin pressurization.

OXYGEN AND COMMUNICATION QUICK DISCONNECT ASSEMBLY

The oxygen and communication quick disconnect assembly is secured to the seat to prevent injury to the pilot during ejection. The oxygen hose retention strap effects positive hose disconnection after man-seat separation. A snap fastener on the retention

strap allows individual adjustment of the oxygen hose to obtain freedom of movement without disconnecting the hose.

ANTI-G SUIT HOSE

The anti-g suit hose is located on the left side of the ejection seat next to the headrest. The hose is held in the stowed position by a flexible spring.

INERTIAL REEL LOCK

An inertia reel lock consisting of a powered reel and cable attachment provides mechanical locking and unlocking of the shoulder harness controlled by an inertia reel lock lever located on the left legbrace. When the handgrips are raised, the power reel is actuated causing the shoulder harness to be forcibly retracted and restrained regardless of the inertia reel lock lever position.

STRAP IN CONNECTIONS

The following connections are attached by various mechanisms and each should be adjusted and checked for security. See Figure 1-36.

- a. Shoulder harness
- b. Oxygen/communications
- c. Safety belt
- d. Beacon actuator tab (snapped)

- e. Anti-g suit hose

AUTOMATIC-OPENING SAFETY BELT

The HBU-12/B safety belt is equipped with a 0.65 second delay which provides automatic belt opening during ejection thereby reducing seat separation and parachute deployment time. This reduces the altitude required for safe ejection. The HBU-12/B safety belt has a push-pull release mechanism that can be actuated by the fingers or palm of either hand. The automatic parachute arming lanyard (silver key) is to be installed on the right side belt link and pressed into the base of the latch assembly in order to lock the belt. To open the buckle, push the lockout lever to expose the tongue unlocking lever which is then pulled in the opposite direction, releasing the tongue of the buckle. The seat belt requires use of an automatic parachute arming lanyard (silver key). See Figure 1-35 for proper connection and operation of the belt.



Failure to properly tighten the safety belt may result in serious injury during ejection and may adversely affect the pilot's ability to actuate cockpit controls during zero or negative G flight.

**T.O. 1T-38C-1
EJECTION SYSTEM**

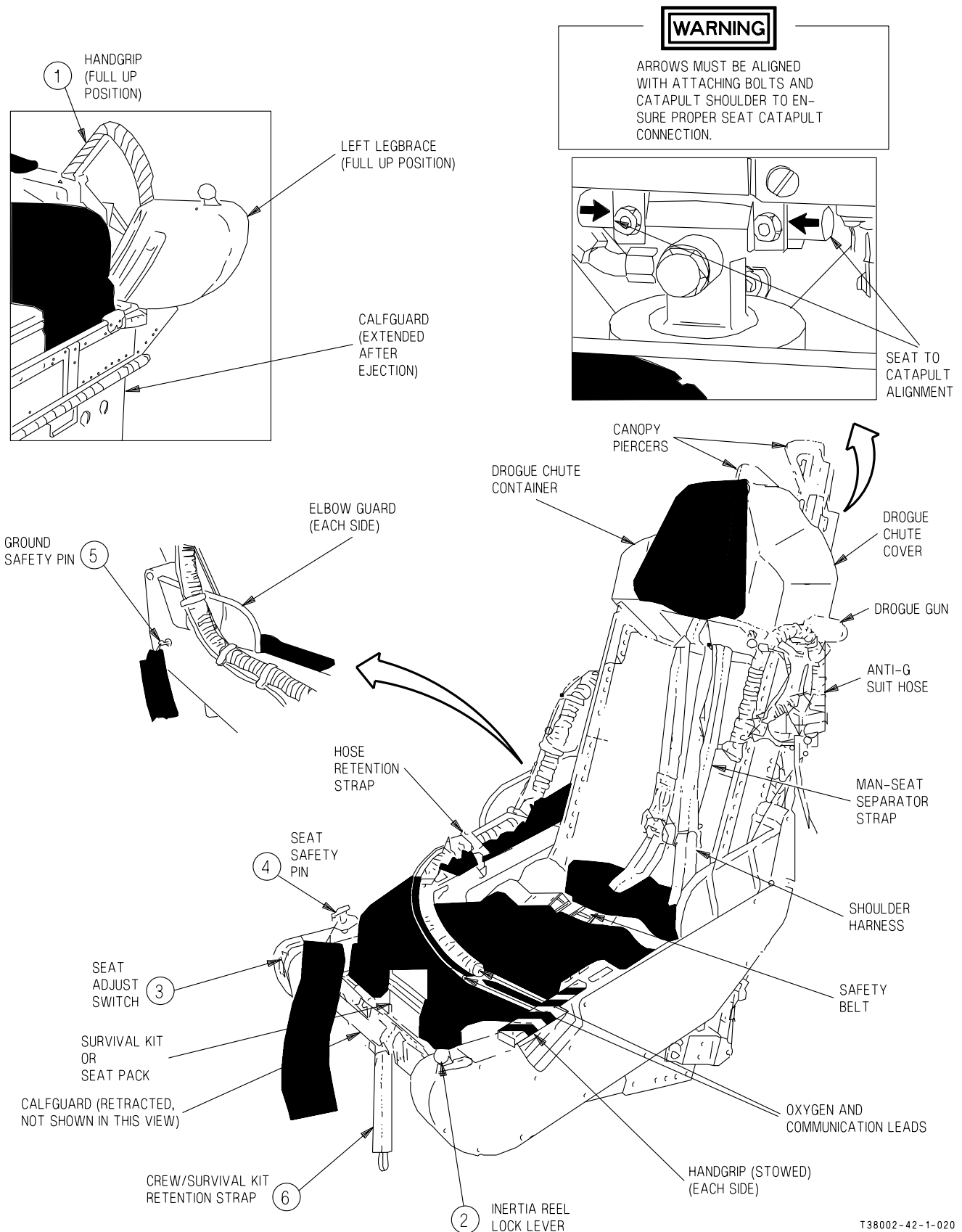

Figure 1-33. Ejection Seat (Sheet 1 of 2)

T38002-42-1-020

CONTROLS	FUNCTION
① Handgrips (Yellow with black diagonal stripes)	Pulling either or both handgrips up to travel limits raises legbraces to the fully up and locked position, retracts and locks the shoulder harness, jettisons the canopy and initiates seat ejection. The first 12° of travel unlocks both legbraces.
② Inertial Reel Lock Lever	<p>LOCK Locks shoulder harness.</p> <p>AUTO Unlocks shoulder harness, freeing it to reel in and out. Harness automatically locks during rapid 3-g acceleration and/or during seat ejection.</p>
③ Seat Adjust Switch	<p>Forward and Hold Lowers seat electrically.</p> <p>Center Spring-loaded neutral position.</p> <p>Aft and Hold Raises seat electrically.</p>
④ Seat Safety Pin	Inserted Holds right legbraces handgrip down. The streamer is attached to the canopy jettison handle safety pin streamer.
⑤ Ground Safety Pin	Provides mechanical safing of the safety belt initiator during ground maintenance.
⑥ Crew/Survival Kit Retention Strap (HBU safety belt only)	Retains crew and survival kit in position during zero and negative g maneuvers.

Figure 1-33. Ejection Seat (Sheet 2)

MAN-SEAT SEPARATION SYSTEM

A man-seat separation system forcibly separates the crewmember from the ejection seat when the safety belt initiator fires after ejection. On ejection, man-seat separation is aided by full deployment of the drogue chute.

PERSONNEL LOCATOR BEACON

A personnel locator beacon installed in the parachute harness is used in locating crewmembers who have ejected. The beacon transmits a signal on 243.0 Mega Hertz (MHz). The beacon operates automatically upon parachute deployment when the actuator tab is snapped to the stud tab below the canopy release on the right-hand main lift web. With the actuator tab unsnapped, the beacon does not operate automatically.

SEAT PACK

The seat pack can be used as a seat bucket spacer when a survival kit is not required for mission accomplishment. The seat pack is secured into the seat by two straps, one attached forward and one attached near the rear of the kit. Ensure the rear strap is properly routed through the man-seat separator strap (Figure 1-34).

SURVIVAL KIT

The survival kit (Figure 1-37) is designed to fit in the ejection seat and be used as a seat cushion with a back type parachute. The survival kit is attached to the parachute harness by two quick disconnect buckle/web strap assemblies. The kit is divided into two sections, an aft section and a forward section. The forward section of the kit top is equipped with a seat

**T.O. 1T-38C-1
EJECTION SYSTEM**



**SEAT PACK
TIEDOWN
STRAPS**

NOTE

**PICTURE TAKEN FROM BACK
OF SEAT.**

T38002-334-1-020

Figure 1-34. Seat Pack (Before T.O.1T-38C-546)

cushion. The aft section serves as a support for the back type parachute. The forward section contains a life raft attached to a 20-foot lanyard and a CO₂ bottle to inflate the life raft. The survival kit is attached to the crewmember's parachute harness by attaching straps on each side of the survival kit.

An emergency release handle is located on the right side of the survival kit forward section. Pulling the emergency release handle during descent after ejection releases and inflates the life raft. Pulling the emergency release handle while seated in the aircraft releases both attaching straps from the survival kit, and the crewmember is free of the unopened survival kit.

WARNING

Seats containing a survival kit or a seat pack with a 4-inch thick cushion shall contain a cutout to prevent interference with control stick full aft movement.

Depending upon local command desires, kit contents vary and can include a life raft.

Automatic/Manual Deployment

The kit is automatically released during the ejection sequence or retained for normal release, depending upon the selected position of the survival kit AUTO/MANUAL selector before ejection. During parachute deployment, the parachute shroud lines pull the kit auto-release cable. If the AUTO/MANUAL selector is in AUTO, pulling the kit auto-release cable causes an initiator cartridge to fire, and after a 4-second delay, the survival kit is automatically released. If the selector is in MANUAL, the cartridge is safetied and the kit must then be released manually by pulling the emergency release handle. When the kit is released, either automatically or manually, the quick disconnect buckle/web assemblies separate from the kit permitting it to open and fall away from the crewmember until the lanyard, attached to the parachute harness, is fully extended. The life raft, if included in the kit, is automatically deployed and inflated.

GROUND EGRESS

NORMAL EGRESS

Normal egress should be accomplished by manually disconnecting both quick disconnect buckle/web strap assemblies from the parachute harness.

NOTE

Binding of the right quick disconnect buckle/web strap is possible while manually disconnecting from the survival kit.

EMERGENCY EGRESS

During emergency ground egress, pulling the emergency release handle releases the survival kit from the parachute harness regardless of the position of the AUTO/MANUAL selector.

NOTE

The pilot's weight must be on the survival kit to ensure the kit is bottomed in the ejection seat bucket while pulling the emergency release handle. Otherwise the lanyard will remain attached to the parachute harness and could cause egress difficulties.

**T.O. 1T-38C-1
EJECTION SYSTEM**

LOCKED

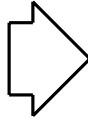

- 1 AUTOMATIC DISCONNECT LINK AND BELT LINK.
- 2 CREW/KIT RETENTION STRAP LOOP OVER BELT LINK BEFORE SHOULDER HARNESS LOOPS.

WARNING

FAILURE TO INSTALL CREW/KIT RETENTION STRAP LOOP ON BELT LINK FIRST MAY DELAY OR NEGATE MAN/SEAT SEPARATION DURING EJECTION.

- 3 RIGHT AND LEFT SHOULDER HARNESS LOOPS OVER BELT LINK.
- 4 ANCHOR (SILVER KEY FROM AUTOMATIC PARACHUTE ARMING LANYARD) OVER BELT LINK.

WARNING

LANYARD MUST BE OUTSIDE PARACHUTE HARNESS AND NOT FOUL ON ANY EQUIPMENT TO PERMIT CLEAN SEPARATION FROM SEAT.

NOTE

ANCHOR MUST BE OVER BELT LINK LAST AND PRESSED INTO THE LATCH BASE IN ORDER TO LOCK THE LATCH.

- 5 BELT LINK INSERTED IN MANUAL LATCH.
- 6 MANUAL RELEASE LEVER LOCKED AND CHECKED.

AUTOMATICALLY OPENED



- 1 AUTOMATIC DISCONNECT LINK RELEASED BY GAS PRESSURE FROM INITIATOR.
- 2 ANCHOR RETAINED IN LATCH ON LEFT BELT AS SEAT FALLS AWAY.
- 3 MANUAL RELEASE LEVER DOES NOT OPEN.
- 4 SHOULDER HARNESS AND CREW/KIT RETENTION STRAP RELEASED FROM BELT LINK.

MANUALLY OPENED

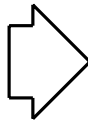

- 1 OPEN MANUAL RELEASE LEVER.

WARNING

IF THE BELT IS MANUALLY OPENED DURING EJECTION, THE PARACHUTE WILL NOT OPEN AUTOMATICALLY UPON SEPARATION FROM THE SEAT.

- 2 ANCHOR RELEASED FROM BELT LINK.
- 3 SHOULDER HARNESS AND CREW/KIT RETENTION STRAP LOOPS RELEASED FROM BELT LINK.

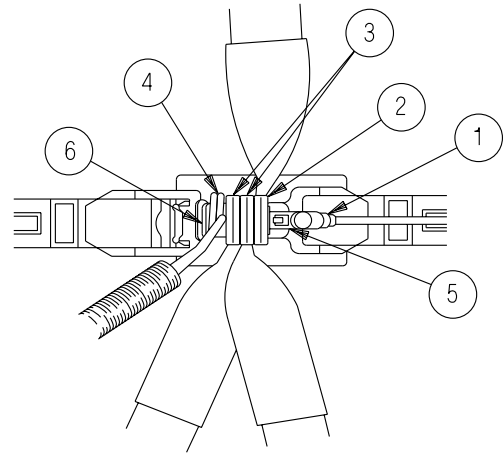

**VIEWS LOOKING DOWN
AIRCRAFT NOSE TOWARDS TOP**

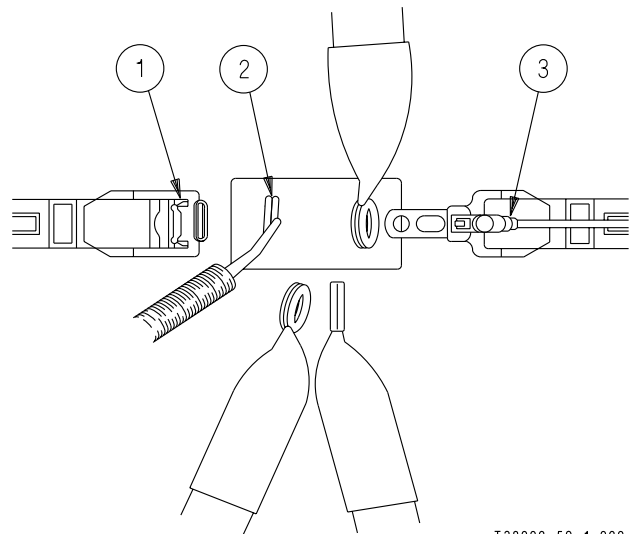
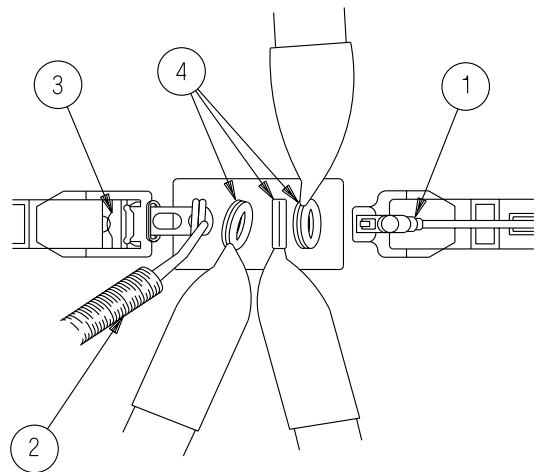

T38002-59-1-020

Figure 1-35. Automatic Opening Safety Belt

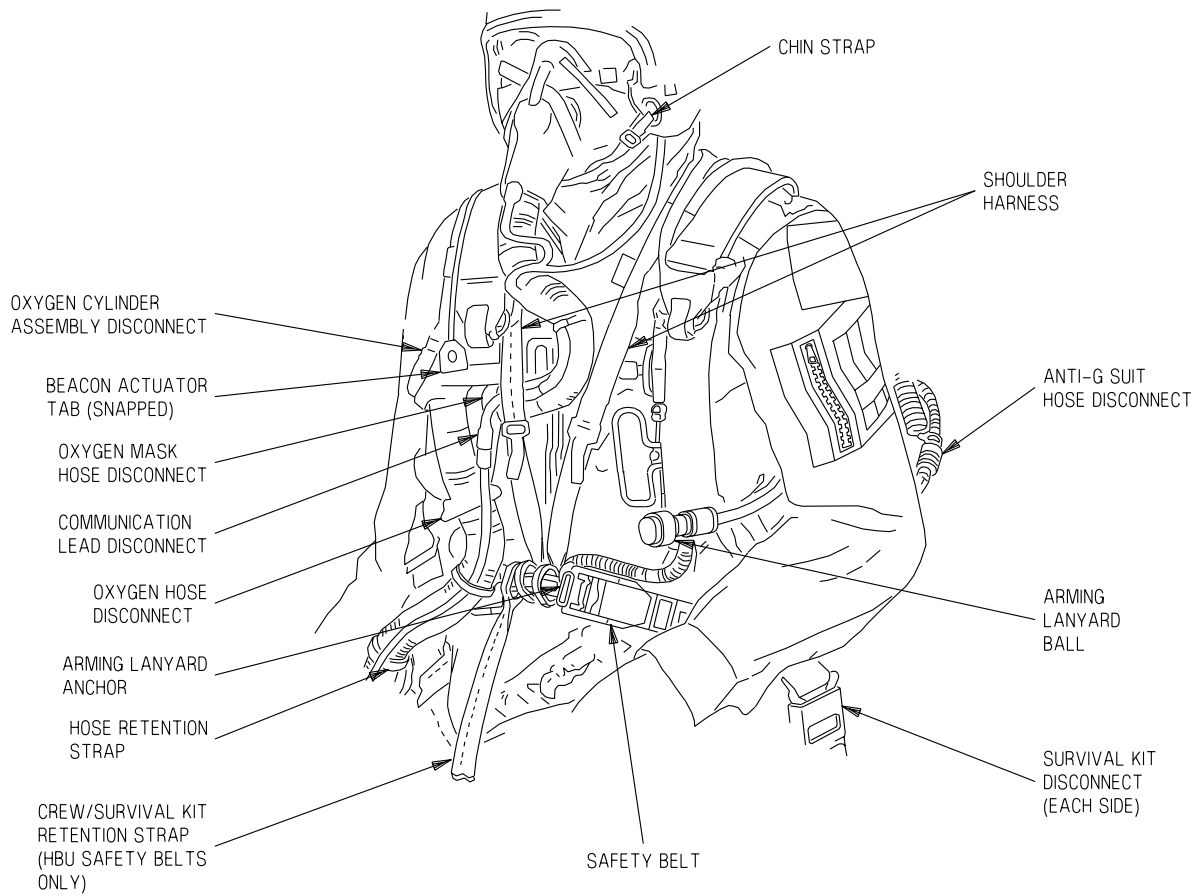

T38002-60-1-020

Figure 1-36. Strap-In Connections

**T.O. 1T-38C-1
EJECTION SYSTEM**

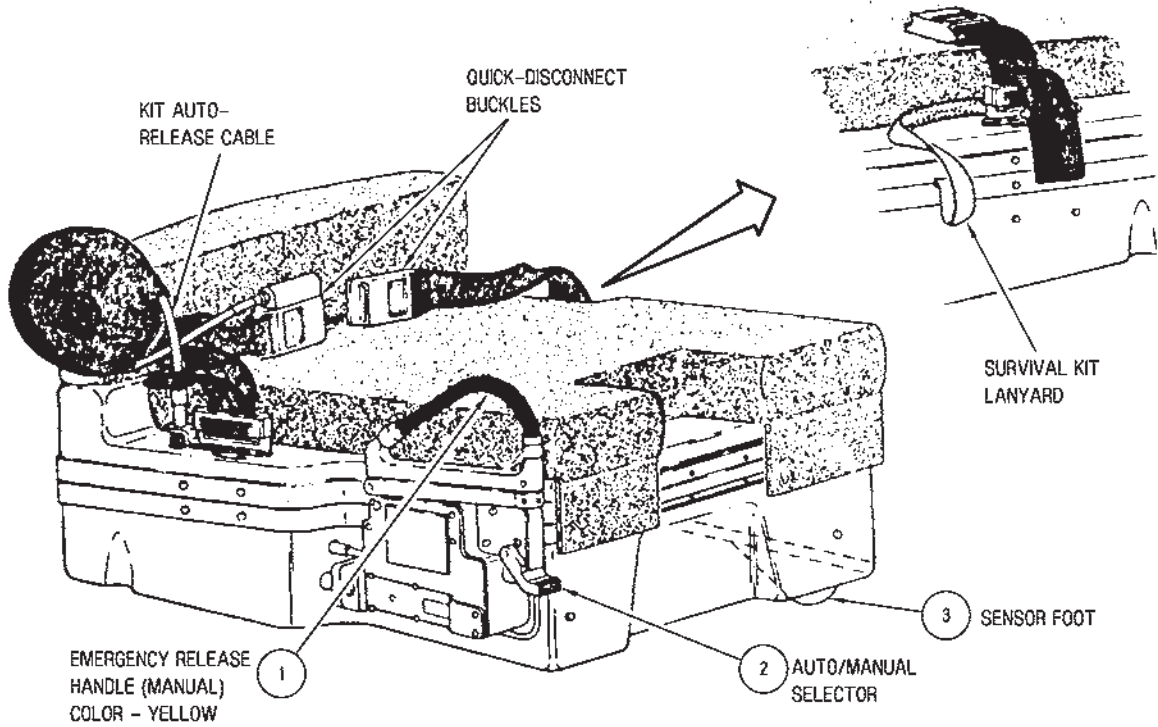

Figure 1-37. Survival Kit

T38J62-58-1-C2C

CONTROLS	FUNCTION	
① Emergency Release Handle	Pull	a. After ejection, with AUTO/MANUAL selector in MANUAL, releases kit. b. While seated on survival kit, regardless of the position of the AUTO/MANUAL selector, releases both quick disconnects from kit.
② AUTO/MANUAL Selector	AUTO (Up) MANUAL (Down)	Permits automatic deployment of survival kit 4 seconds after parachute shroud lines are fully stretched. Permits manual deployment of survival kit when emergency release handle is pulled.
③ SENSOR FOOT	For emergency ground egress, the kit has to be bottomed in the seat bucket, pressing the sensor foot, for the lanyard to release.	

EJECTION SYSTEM (AFTER T.O. 1T-38C-546)

INTRODUCTION

The US16T-1 (FCP) and US16T-2 (RCP) ejection seats are lightweight, catapult seats operated by cartridges with the aid of a rocket motor, Figure 1-38. The ejection seat gives safe escape for most values of the aircraft's height, velocity, attitude and flight path (within the envelope from zero height at zero velocity in a near level attitude, and the limits of the aircraft's maximum velocity, between zero and maximum height).

An ejection sequence is started when the ejection handle on the front of the ejection seat between the aircrew's thighs is pulled.

A gas operated Inter-Seat Sequencing System (ISS) mode is selected to sequence ejection for both aircrew dependent on the position of the ISS knob (RCP). A solo mode is also selectable. This gives the shortest possible time for front seat ejection without the interval for the rear seat being ejected first.

After ejection, a drogue and bridle system stabilizes the seat and decreases forward velocity. A personnel parachute automatically deploys and the aircrew member automatically separates from the seat. A Manual Override (MOR) system can be used to start parachute deployment and the separation sequence if the automatic system and automatic backup system fails.

EJECTION SEAT

EJECTION HANDLE

A yellow and black striped Ejection Handle, Figure 1-38, is located on the front of the ejection seat between the aircrew's thighs.

A safety pin attached to a red streamer, Figure 1-39, is put through the handle to make the ejection seat SAFE. The safety pin cannot be installed if the SAFE/ARMED lever is in the ARMED position. With the seat in the ARMED position, when the ejection handle is pulled, the ejection sequence is started.

EJECTION HANDLE OPERATION

- a. One-hand procedure - Hold the ejection handle with your strongest hand, with the palm toward your body. Hold the wrist of

- the strongest hand with your weakest hand, with the palm of that hand toward your body. Keep your elbows close to your body.
- b. Two-hand procedure - Hold the ejection handle with the thumb and not less than two fingers of each hand, with the palms of your hands toward your body. Keep your elbows close to your body.

SAFE/ARM LEVER

A SAFE/ARMED lever, Figure 1-39 is found on the left side of the ejection seat and locks the ejection handle when the safety pin is removed. In the SAFE position, the handle is white with SAFE written in black letters. In the ARMED position, the handle has black and yellow stripes with ARMED written in black letters. The SAFE/ARMED lever cannot be put into the ARMED position when the ejection handle safety pin is installed.

MANUAL OVERRIDE (MOR) HANDLE

A yellow and black striped MOR handle, Figure 1-38, is provided to initiate aircrew/seat separation if the automatic system fails or if aircrew/seat separation is desired above 14,000 feet MSL. The handle is located on the right side of the ejection seat. The MOR handle cannot be operated before the seat ejects.

After ejection, the handle is free to function. The handle is locked in the down position by a catch operated by a thumb button situated at the forward end of the handle. Depressing the thumb button allows the handle to be rotated upward. Operation of the handle after ejection will fire a cartridge to operate the upper and lower harness locks, the upper and lower bridle locks, and the headbox deployment unit (HBDU).

LEG RESTRAINTS

A leg restraint system is installed on each ejection seat to restrain the legs during ejection to minimize leg injuries due to flailing. The system has two leg restraint lines (one for each leg) with break rings, two leg restraint line locks, two snubbers, two lower leg garters (one on the lower calf of each of the leg, immediately above the boot) and two upper leg garters (one on the thigh of each leg, immediately above the knee).

T.O. 1T-38C-1

EJECTION SYSTEM

During ground egress, the leg garters may be released by individually operating the release button for each line or by operating the quick release lever on the forward left side of the ejection seat.

During ejection, inertia draws the legs toward the front of the seat bucket. When the lines become taut and a predetermined load is attained, the attachment shear rings break, freeing the lines from the aircraft. The leg lines are restrained by the snubbers and the aircrew legs are secured until the leg lines are released when harness release occurs.

EMERGENCY OXYGEN (EO) HANDLE (Green Ring)

A green, looped, manually operated ring, Figure 1-38, is located on the left side of each ejection seat. The EO handle operates a mechanism that causes the EO cylinder to supply oxygen.

EMERGENCY OXYGEN CYLINDER

An emergency oxygen cylinder, gauge, and associated plumbing are installed on the inner left side of the ejection seat. An emergency oxygen supply hose is located on the right side of the ejection seat which connects the CRU-60/P to the emergency oxygen supply system. The emergency cylinder supplies oxygen for a short period of time, approximately 10 minutes or until aircrew/seat separation. The system automatically activates when the EO handle is manually pulled or during ejection. The emergency oxygen cylinder is sufficiently charged when the contents pointer is between 1800-2500 PSI.

Descent to 10,000 feet cabin altitude or lower is necessary within the 10 minutes or the aircrew may experience the effects of hypoxia.

NOTE

- When the emergency oxygen system is actuated, high pressure air will make verbal communication with the other crewmember or ATC virtually impossible.
- Disconnecting the main oxygen supply hose from the CRU-60/P improves breathing capability by providing pressure relief and improves anti-suffocation capability by reducing resistance.
- Avoid inadvertently disconnecting COMM cable when disconnecting main oxygen hose.

- Once activated, ejection seat emergency oxygen cannot be shut off and will provide oxygen flow until the cylinder is depleted (approximately 10 minutes).

SEAT ADJUST SWITCH

The seat adjust switch, Figure 1-38, is on the right side of the ejection seat and raises or lowers the seat bucket. The seat adjust switch is spring-loaded to the center OFF position. Push the switch forward to lower the seat bucket and pull the switch aft to raise the seat bucket.



Do not operate the seat adjust switch for more than 1 minute in any 8 minute period or the seat actuator could be damaged.

SHOULDER HARNESS INERTIA REEL LEVER

A shoulder harness inertial reel lever, Figure 1-38, is located on the left side of the ejection seat. The lever has two positions; forward (unlocked) and aft (locked). When the lever is in the forward (unlocked) position, the reel permits the aircrew to lean forward and twist around in the seat for maximum visibility or to reach controls. When the lever is in the aft (locked) position, the aircrew is restrained in the retracted (shoulders back) position.

When the shoulder harness reel is in the normal unlocked state, the aircrew is protected against rapid forward movement under sudden deceleration by automatic locks. The locks respond to an excessive rate of strap extraction or aircraft deceleration. On rapid strap extraction or aircraft deceleration, the reel mechanism will lock and when the extraction or deceleration load is released, the reel will revert to the normal free state.

SEAT SURVIVAL KIT (SSK)

The SSK is installed in the ejection seat, Figure 1-42. The seat cushion is attached to the top of the sitting platform and designed to give a shape to provide maximum support and comfort. The SSK has an internal fabric container which can hold survival aids.

Attached to the right side of the SSK is a mode selector knob for the automatic deployment unit (ADU) and a kit release handle. The ADU selector

knob is a two mode switch, AUTO or MANUAL. To set the ADU to the AUTO or MANUAL mode, pull and hold the mode selector knob against the spring pressure. Then turn the mode selector knob until the arrow points to the necessary caption on the ADU body. Let the spring pressure pull the mode selector knob into the body. Try to turn the mode selector knob to make sure that the mode selector knob is held in the set position.

During ejection, as the aircrew is pulled from the seat, the static line pulls the sear out of the ADU. The sear releases the firing pin which, if the ADU is set to AUTO, fires a four second delay cartridge. After the four second delay, the cartridge gives gas pressure which retracts a piston to release the strap which attaches the SSK to the lower harness. This lets the SSK fall to the end of the lowering line. If the ADU is set to MANUAL, a mechanism prevents the firing pin from firing the cartridge and the kit release handle must be manually pulled to deploy the SSK.

WARNING

Do not disconnect the quick-release connectors of the LH/RH attachment straps of the SSK from your torso harness. If you disconnect the quick release connectors, the SSK is fully released. Your chances of survival are decreased when you do not have the SSK.

STRAP IN CONNECTIONS

The following connections are attached by various mechanisms and each should be adjusted and checked for security. See Figure 1-43.

- a. Shoulder harness
- b. Oxygen/communications
- c. Lap belt
- d. Leg restraint garters
- e. Anti-g suit

PARACHUTE ASSEMBLY

The parachute container (headbox) contains a GQ Type 5000 parachute. During the ejection sequence, the headbox deployment unit (HBDU) deploys the parachute container. Then the parachute rigging lines, followed by the canopy, are pulled from the bottom of the parachute container. The parachute canopy and steering lines are connected to the parachute lift webs. The parachute lift webs have upper harness release fittings for attachment to the upper torso harness and the Universal Water-Activated System (UWARS).

CANOPY JETTISON SYSTEM

During the ejection sequence, but before the ejection seat ejects, a canopy jettison system removes the respective canopy. If the canopy jettison system does not operate, the canopy breakers on the parachute assembly break the canopy to let the ejection seat eject safely.

**T.O. 1T-38C-1
EJECTION SYSTEM**

(AFTER T.O. 1T-38C-546)

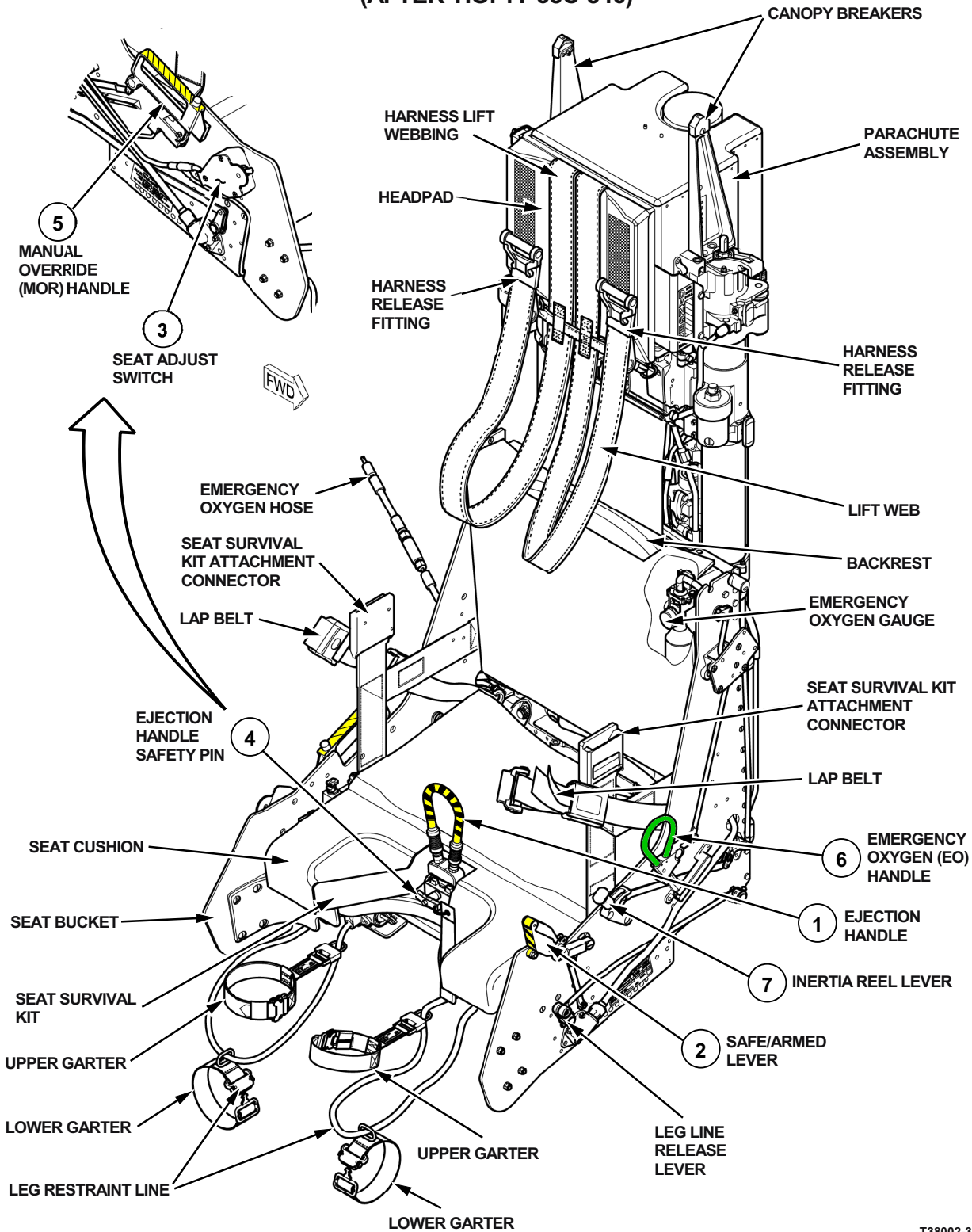

Figure 1-38. Ejection Seat (Sheet 1 of 2)

T38002-351-1-020

CONTROLS	FUNCTION
① Ejection Handle (Front of seat bucket with yellow and black diagonal stripes)	Pulling the handle initiates the ejection sequence.
② Safe/Armed Lever	<p>SAFE When the lever is in the SAFE position, the trigger at the top aft of the lever is white and has the caption SAFE in black letters.</p> <p>ARMED When the lever is in the ARMED position, the top of the lever is yellow with black stripes, and has the caption ARMED in black letters.</p>
③ Seat Adjust Switch	<p>Forward and Hold Lowers seat.</p> <p>Center Spring-loaded off position.</p> <p>Aft and Hold Raises seat.</p>
④ Ejection Handle Safety Pin	Inserted Prevents Safe/Armed Lever from being placed in the ARMED position. A streamer is attached to the safety pin.
⑤ Manual Override (MOR) Handle	The MOR handle operates a mechanism that causes aircrew/seat separation if the automatic sequence or automatic backup system has failed. To operate, push the thumb button at the front of the handle into the handle and hold. Then pull the MOR handle.
⑥ Emergency Oxygen Handle	Initiates the flow of emergency oxygen from the cylinder.
⑦ Inertia Reel Lever	<p>The inertia reel lever operates a mechanism that can lock or release the shoulder harness. This mechanism controls the shoulder harness movement forward and aft in the seat.</p> <p>Aft Inertia reel is locked.</p> <p>Forward Inertia reel is unlocked.</p>

Figure 1-38. Ejection Seat (Sheet 2)

**T.O. 1T-38C-1
EJECTION SYSTEM**

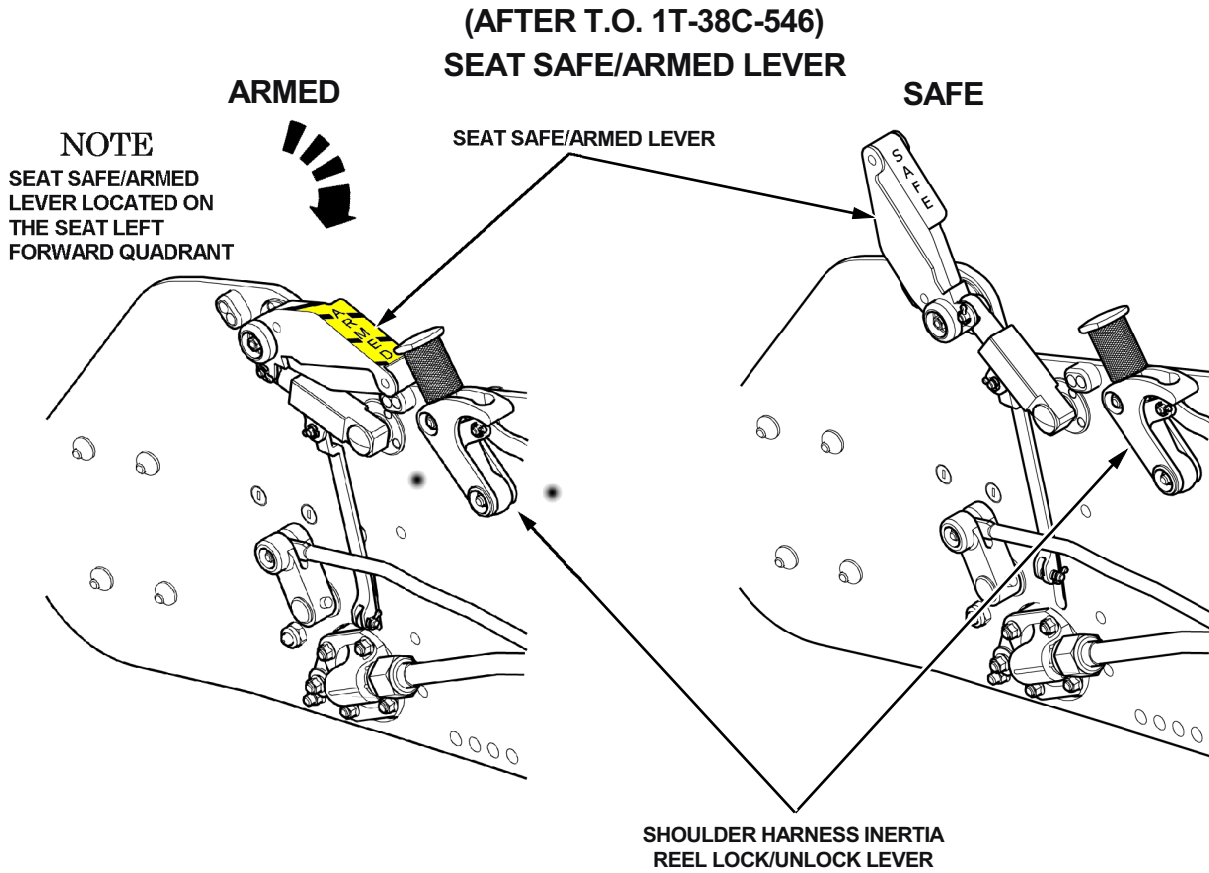

EJECTION HANDLE SAFETY PIN

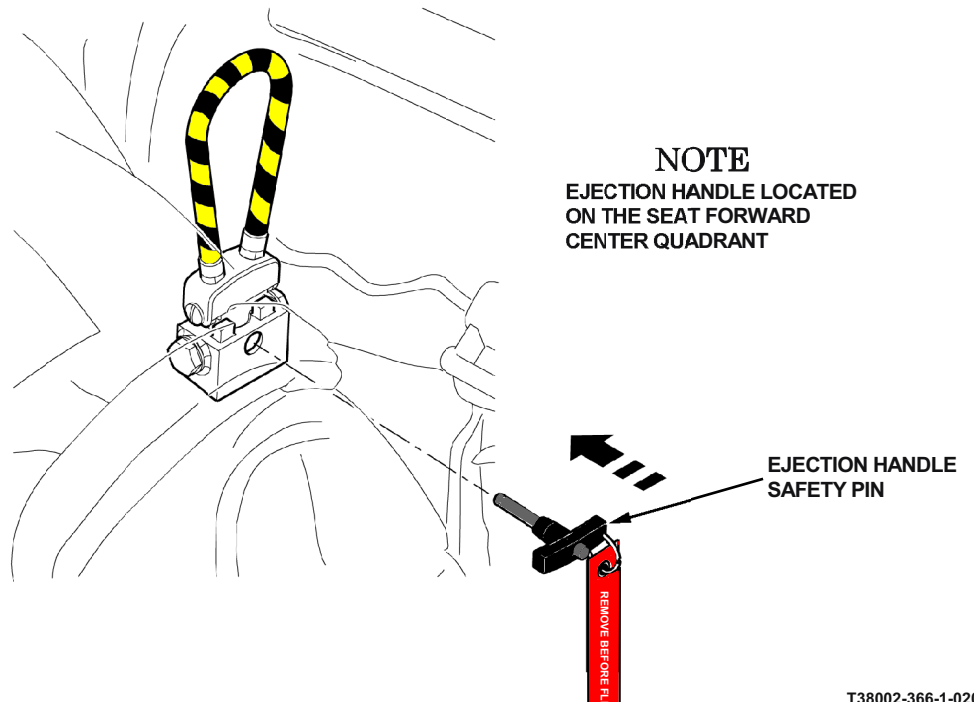
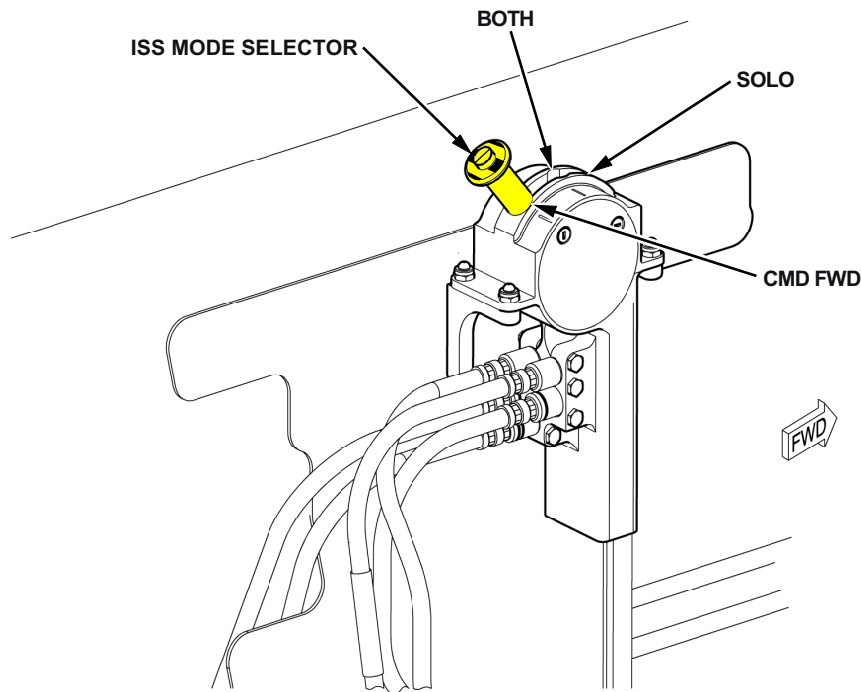

Figure 1-39. Ejection Seat Safety Devices

T38002-366-1-020

(AFTER T.O. 1T-38C-546)



T38002-355-1-020

Figure 1-40. Inter-Seat Sequencing System (ISS) Selector Valve (Rear Seat Only)

INTER-SEAT SEQUENCING SYSTEM (ISS)

A yellow and black striped ISS mode selector in the rear cockpit, Figure 1-40, sets one of three modes to fire the ejection seats in a specified sequence. The spring-loaded handle moves in a quadrant between the three set positions. The modes are SOLO, CMD FWD and BOTH.

Pull and hold the handle against the spring pressure, then move the control handle in the quadrant. Move the handle adjacent to the caption of the mode you must set. Let the spring pressure pull the handle into the hole in the quadrant to hold the handle adjacent to the necessary caption. Try to move the lever forward and aft to make sure the lever is held in the set position.

When the mode selector is set to the applicable position, the ISS sequence occurs as follows:

ISS Selector in SOLO MODE. When the front seat firing handle is pulled, only the front seat ejection

sequence is started. If the rear seat firing handle is pulled, only the rear seat ejection sequence is started.

NOTE

- Because the rear seat is not ejected in SOLO mode, the front seat is ejected with a 0.4 second time-delay. Gas pressure is redirected through the ISS to start the ejection sequence in this shorter time.
- The SOLO mode should be used when the aircraft is flown with one aircrew.

ISS Selector in CMD FWD MODE. When the front seat firing handle is pulled, the ejection sequence is started for the two seats. If the rear seat firing handle is pulled, only the rear seat ejection sequence is started.

ISS Selector in BOTH MODE. The ejection sequence is started for the two seats when the front or rear seat firing handle is pulled.

**T.O. 1T-38C-1
EJECTION SYSTEM**

BAROSTATIC TIME RELEASE UNIT (BTRU)

The Mk-16T is a 3 mode seat (high altitude mode, medium altitude mode, and low altitude mode). Mode selection is made by the BTRU as a function of speed and altitude conditions at the time of ejection, Figure 1-41. The sensing capability of the BTRU is provided by three separate and unique units:

- a. The main barostatic G interdictor (high altitude)
- b. The barostatic G interdictor (medium altitude)
- c. The low altitude G interdictor (low altitude)

Depending on airspeed and altitude conditions at ejection, the proper interdictor for those conditions initiates recovery parachute deployment such as to provide optimal system timing while minimizing aircrew injury and parachute damage due to excessive parachute opening loads. See chart below.

In the following conditions, the BTRU cartridge will be fired 0.5 seconds after the barostat or g switch release the firing pin mechanism.

Altitude more than 15,000 feet

The barostat capsule of the BTRU prevents the operation of the BTRU above an altitude of 15,000 feet. The aircrew falls, in the seat, kept stable by the drogue. The barostat capsule of the BTRU lets the BTRU operate at an altitude of 15,000 feet.

Altitude below 15,000 feet, but more than 12,000 feet

The barostat controlled g switch in the BTRU prevents the operation of the BTRU, until the g load is less than 3.25 g's.

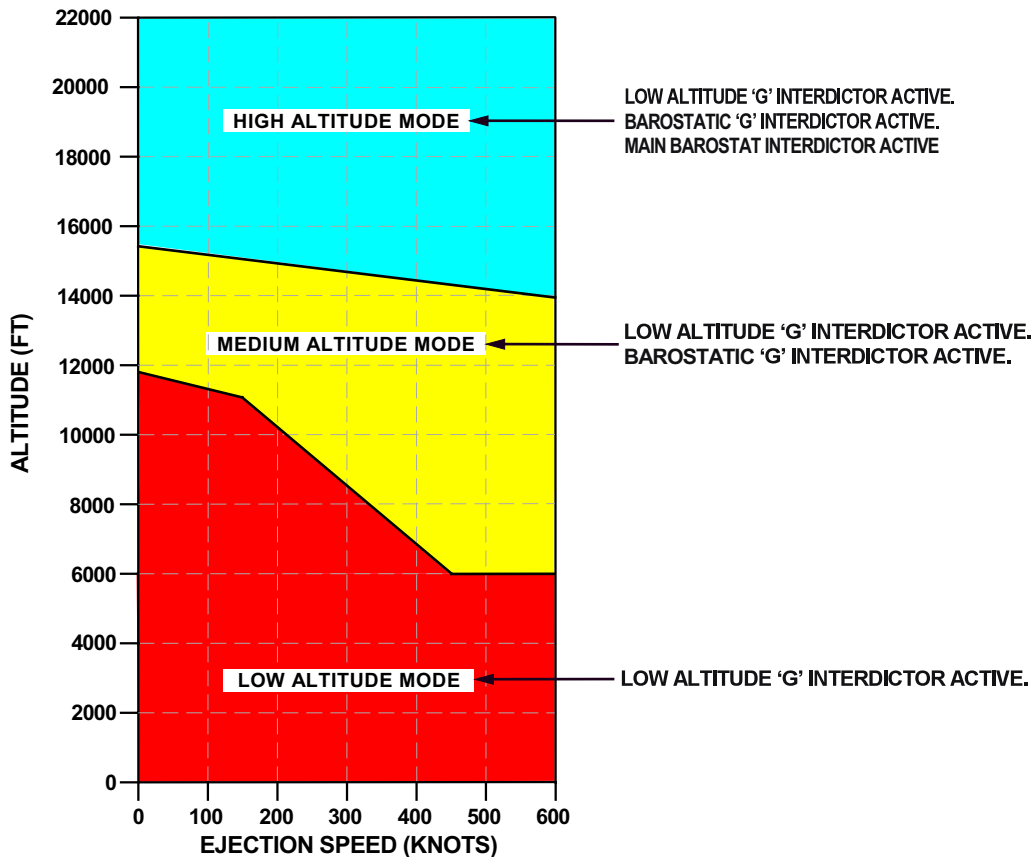

Figure 1-41. Barostatic Time Release Unit (BTRU)

T38002-620-1-020

Altitude below 12,000 feet

The barostat controlled G switch in the BTRU prevents the operation of the BTRU, until the G load is less than 6.20 G.

TIME DELAY UNIT (TDU)

Gas from the TDU cartridge is supplied to release the upper and lower harness locks and leg restraint lines. The short delay before the TDU cartridge fires keeps the aircrew in the seat against the reaction force of the HBDU, but releases the locks before the parachute inflates.

AUTOMATIC BACKUP UNIT OPERATION (ABU)

The ABU functions are auxiliary functions to the functions of the BTRU and Time Delay Unit (TDU).

The barostat capsule in the ABU prevents the operation of the ABU above an altitude of 12,000 feet. If the BTRU and TDU do not operate, the aircrew falls, in the seat, kept stable by the drogue. The barostat capsule in the ABU lets the ABU operate at an altitude of 12,000 feet.

When the ABU is released, and the 3.3 second interval has expired, the ABU cartridge is fired. Gas pressure from the ABU cartridge fires the HBDU cartridge and supplies gas pressure to unlock:

- a. The upper and lower drogue bridle locks.
- b. The lap straps.
- c. The leg restraint lines.
- d. The shoulder straps.

OXYGEN, COMMUNICATION AND ANTI-G SUIT DISCONNECT

After ejection is initiated, gas pressure operates the shoulder harness inertia reel and locks the aircrew into the correct position for ejection, fires the canopy ejection system, moves the seat up the guide rails automatically disconnecting the oxygen, communication and anti-g suit from the aircraft supplies.

AIRCREW/SEAT SEPARATION

Gas pressure supplied to the Headbox Deployment Unit (HBDU) deploys the parachute container and gas pressure from the Time Delay Unit (TDU) releases the lap belt, leg restraint and shoulder harness. The parachute initial opening shock forcibly separates the aircrew from the ejection seat.

PERSONAL LOCATOR BEACON

A beacon lanyard attached to the seat bucket automatically activates the beacon in the SSK during aircrew/seat separation.

PARACHUTE STEERING LINES

The steering lines have red handles attached by hook and loop fasteners to the aft face of the Left and Right forward lift webs. When the parachute opens, two guide rings keep each handle end of the steering lines near to the related forward lift web. The steering line allows the aircrew to open and close the canopy vents in the canopy. The canopy vents control the velocity and direction of the flight of the parachute.

ANTI-G SUIT HOSE

The anti-g suit hose (Figure 1-43) is located on the left side of the ejection seat near the headrest. The hose is held in the stowed position by a flexible spring.

GROUND EGRESS

NORMAL EGRESS

Normal egress is accomplished by placing the SAFE/ARMED lever in the SAFE position, inserting the ejection seat safety pin in the ejection handle, then manually disconnecting from the parachute/shoulder harness, oxygen/communication, lap belt, left and right leg garters, seat survival kit, anti-g suit connectors and placing the ISS mode selector to the SOLO position (rear seat only).

(AFTER T.O. 1T-38C-546)
FORWARD SECTION OF SSK

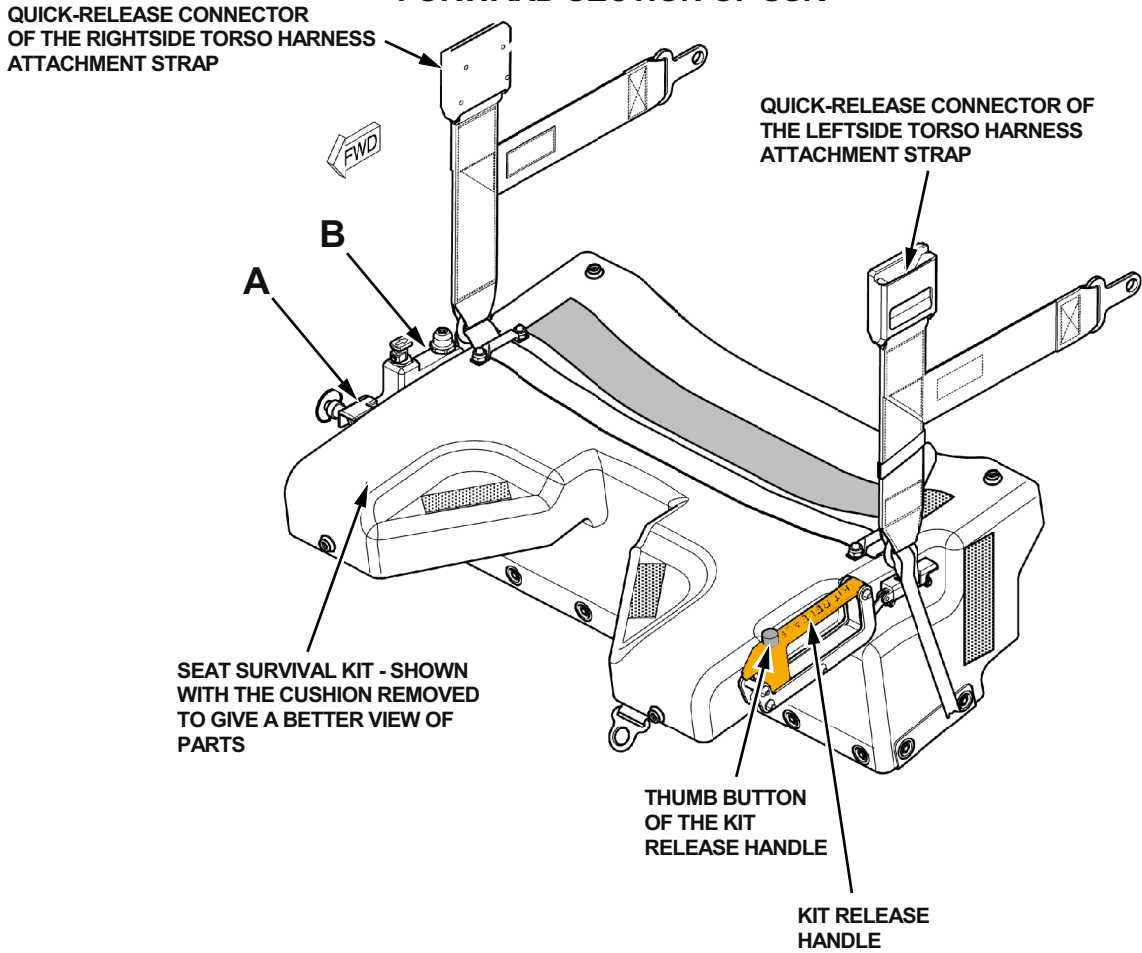

A
Automatic Deployment Unit (ADU)

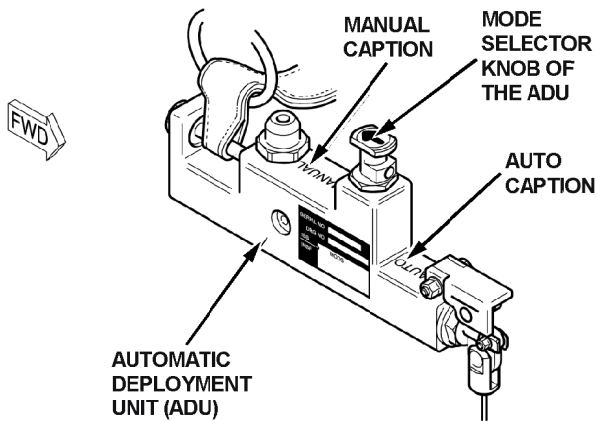

B
Right Forward Section of SSK

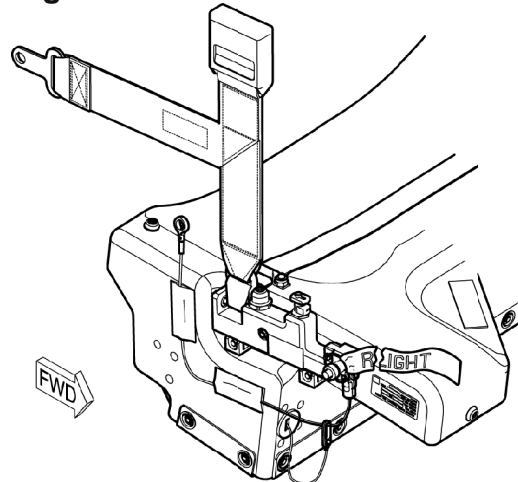

Figure 1-42. Seat Survival Kit (SSK)

T38002-372-1-020

(AFTER T.O. 1T-38C-546)

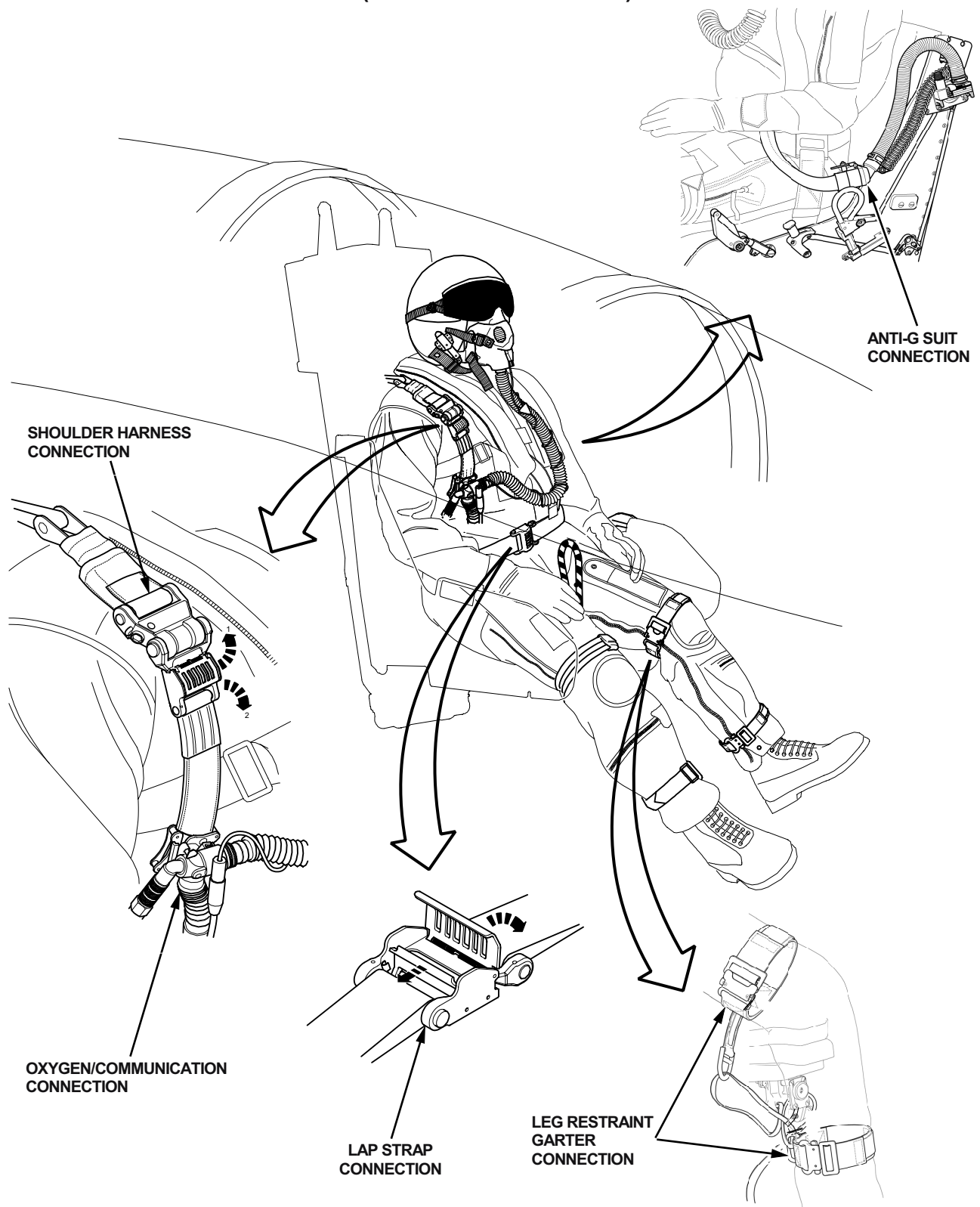

Figure 1-43. Strap-in Connections

T38002-358-1-020

OXYGEN SYSTEM

OXYGEN REGULATOR PANEL

The aircraft uses a liquid oxygen system to supply oxygen to the aircrew. The oxygen regulators (automatic diluter demand) control the flow and pressure of the oxygen and distribute it in the proper proportions to the masks. One of two types of Oxygen Regulator Panels on the right console of each cockpit contains an OXYGEN SUPPLY PRESSURE gauge (Figure 5-2), a diluter lever, and a supply lever. The later type regulator differs from the earlier type regulator in that when the supply lever is OFF, the flow of oxygen and cockpit air to the oxygen mask are both cut off. On earlier type regulators, cockpit air only flows to the mask with the supply lever OFF. See Figure 1-44 for the oxygen duration chart.

OXYGEN QUANTITY

OXYGEN QUANTITY INDICATOR

An oxygen quantity indicator, operating on AC and located on the right sub-panel of each cockpit, indicates converter liquid oxygen quantity in liters. The indicator is provided with an OFF flag, which appears in case of electrical power failure.

OXYGEN SUPPLY PRESSURE GAUGE

Refer to OPERATING LIMITATIONS Section V.

OXYGEN LOW LEVEL CAUTION LIGHT

An OXYGEN low-level caution light on the Caution Light Panel in each cockpit illuminates when the oxygen quantity indicator reads 1 liter or less of liquid oxygen. The light can blink, due to oxygen sloshing, if the system contains less than 3 liters.

OXYGEN CHECK SYSTEM

Oxygen quantities and indicator operation can be checked by the OXY/FUEL Switch on the right sub-panel of the front cockpit. The three-position switch is spring-loaded to the unmarked OFF position. With external or generator AC power, oxygen quantities are indicated when the switch is in the unmarked OFF position. To check operation of the oxygen quantity indicators, the switch is held in GAGE TEST. The indicator pointers should move counterclockwise. When the switch is released, each indicator pointer returns to indicate the oxygen quantities. With battery power only, the OXY/FUEL Switch is held in QTY CHECK to read the oxygen quantities on board the aircraft. The static inverter supplies AC power to the indicating circuits when the switch is actuated.

	COCKPIT ALTITUDE (FEET)	CREWMEMBER DURATION IN HOURS												
ONE CREWMEMBER	40,000 & ABOVE	56	50	45	39	33	28	22	16	11	5.6	EMERGENCY DESCEND TO ALTITUDE NOT REQUIRING OXYGEN		
		56	50	45	39	33	28	22	16	11	5.6			
	35,000	56	50	45	39	33	28	22	16	11	5.6			
		56	50	45	39	33	28	22	16	11	5.6			
	30,000	40	36	32	28	24	20	16	12	8.1	4.0			
		41	37	32	29	25	20	16	12	8.3	4.1			
	25,000	31	28	25	21	18	15	12	9.4	6.2	3.1			
		39	35	31	27	23	19	15	11	7.8	3.9			
	20,000	23	21	19	16	14	11	9.5	7.1	4.7	2.3			
		44	40	35	31	26	22	17	13	8.9	4.4			
	15,000	19	17	15	13	11	9.5	7.6	5.7	3.8	1.9			
		54	48	43	37	32	27	21	16	10	5.4			
	10,000	15	13	12	10	9.2	7.6	6.1	4.6	3.0	1.5			
		54	48	43	37	32	27	21	16	10	5.4			
	TWO CREWMEMBERS	40,000 & ABOVE	28	25	22	19	16	14	11	8.4	5.6		2.8	EMERGENCY DESCEND TO ALTITUDE NOT REQUIRING OXYGEN
			28	25	22	19	16	14	11	8.4	5.6		2.8	
		35,000	28	25	22	19	16	14	11	8.4	5.6		2.8	
			28	25	22	19	16	14	11	8.4	5.6		2.8	
30,000		20	18	16	14	12	10	8.1	6.1	4.0	2.0			
		20	18	16	14	12	10	8.3	6.2	4.1	2.0			
25,000		15	14	12	11	9.4	7.8	6.2	4.7	3.1	1.5			
		19	17	15	13	11	9.8	7.8	5.9	3.9	1.9			
20,000		11	10	9.5	8.3	7.1	5.9	4.7	3.5	2.3	1.1			
		22	20	17	15	13	11	8.9	6.6	4.4	2.2			
15,000		9.5	8.6	7.6	6.6	5.7	4.7	3.8	2.8	1.9	0.9			
		27	24	21	18	16	13	10	8.1	5.4	2.7			
10,000		7.6	6.9	6.1	5.3	4.6	3.8	3.0	2.3	1.5	0.7			
		27	24	21	18	16	13	10	8.1	5.4	2.7			
LIQUID CONTENTS (LITERS)		10	9	8	7	6	5	4	3	2	1	BELOW 1		
		TOP FIGURES INDICATE DILUTER LEVER "100% OXYGEN"												
		BOTTOM FIGURES INDICATE DILUTER LEVER NORMAL OXYGEN												

Figure 1-44. Oxygen Duration Hours

AVIONICS SYSTEMS

AVIONICS OVERVIEW

The avionics systems provide the computations required for each Master Mode: Navigation (NAV), Air-to-Ground (A/G), and Air-to-Air (A/A). Selection of any master mode via the Master Mode Switch (MMS) on the Stick Grip or MFD Option Select Button (MOSB) MR-5 on the PFR or HSD Display Page, automatically sets the appropriate subsystems, sensors, controls, and displays necessary for the chosen operation.

AVIONICS MASTER MODES

NAV MASTER MODE

When NAV is selected, ground point steering directions appear on the HUD and MFD (HSI/HSD). Navigation can be accomplished via one of ten pre-planned flight plans (routes 0 through 9). When steering commands and required speed indications are followed, the selected objective can be reached at a predetermined Time On Target (TOT). Flight plan data can be loaded via the Data Transfer System (DTS) or UFCP, and can be reconfigured / modified in flight via the UFCP.

The system allows the use of approximately 80,000 International Civil Aviation Organization (ICAO) points and approximately 300 additional predefined / selectable destinations. Up to ten destinations can be paired with approach data (ground based or self contained) for using Preprogrammed Approaches (PPA). Refer to PREPROGRAMMED APPROACHES (PPA), this section.

A/G MASTER MODE

The A/G master mode allows simulated delivery of A/G weapons (bombs and gun). Refer to T.O. 1T-38C-34-1-1.

A/A MASTER MODE

The A/A master mode allows simulated delivery of A/A short range missiles and guns. Refer to T.O. 1T-38C-34-1-1.

MISSION DISPLAY PROCESSOR (MDP)

The core of the avionics system is the MDP. See AVIONICS FUNCTIONAL OVERVIEW, Figure FO-4 for an overview of how the MDP interacts with other aircraft systems. The main MDP functions are:

- a. Systems and subsystems operation control.
- b. HUD/UFCP/MFD control and displays.
- c. Pilot-systems interface (HOTAS/UFCP/MFD /DTS).
- d. Navigation computations and steering commands.
- e. Simulated weapons delivery computations; refer to T.O. 1T-38C-34-1-1.
- f. Warnings/Cautions/Advisories (WCA) system controls and displays.
- g. Fault List controls and displays.
- h. Video Tape Recorder (VTR) operational control.
- i. Voice communication and radio navigational control.

Electrical power to the MDP is controlled via the Avionics Activation Panel (AAP). During MDP power-up, approximately 50 seconds are required for full system (cold) boot.

NOTE

If the MDP fails to boot, the MDP power switch on the AAP should be cycled OFF then ON.

MDP OPERATION DURING ELECTRICAL POWER INTERRUPTIONS

A MDP warm boot may result from the brief power interruptions that occur during engine starts or generator crossovers. During these power interruptions the avionics suite switches to backup operations/displays for approximately 10 seconds until the MDP is operational again.

Power interruptions longer than 300 msec cause the MDP to perform a full system (cold) boot. The avionics suite switches to backup displays/operations for approximately 50 seconds until the MDP is operational again.

The MDP retains the following pre-entered parameters and values during warm and cold boots:

- a. Communication radio settings (UHF and VHF).
- b. Navigation radio frequencies and channels (VOR/ILS, TACAN).
- c. Primary Navigation Source (PNS).
- d. Selected Flight Plan (FPL).
- e. 4 digit IFF code.
- f. Altimeter setting and altitude warnings (default to values from the DTC).
- g. Selected course and heading set marker.
- h. Selected training zones and no-fly zones.
- i. Manual speed bugs (G only; Y speed reverts to 20 knots higher than G speed).
- j. Tail number and engine type (PMP/No PMP).

All other parameters are set to their default values (most parameters are as stored during the last DTS operation).

NOTE

The MDP may not operate through all generator crossovers. MDP response is dependent on the generator crossover connection times (inconsistent and unpredictable). Right/left generator crossovers may generate MDP PFLs/MFLs associated with rear cockpit MFD video operations and HUD camera periodic BIT functions.

AIR DATA COMPUTER (ADC)

The ADC provides data to the MDP to perform the following:

- a. Simulated weapon delivery.
- b. Bomb scoring.
- c. Gear up/down status-related functions.
- d. Automatic calculation of approach speeds based on flap position.
- e. A/A gunnery steering commands.
- f. Yaw damper transfer function.
- g. Flight parameter display (Altitude, Airspeed, and AOA) on the HUD and MFD.

The ADC provides air data to the TCAS system for traffic alerts and avoidance. The ADC directly controls the AOA indexer in each cockpit.

AVIONICS ACTIVATION PANEL (AAP)

The following avionics subsystems are turned ON/OFF via the AAP, Figure 1-45, located on the FCP left console:

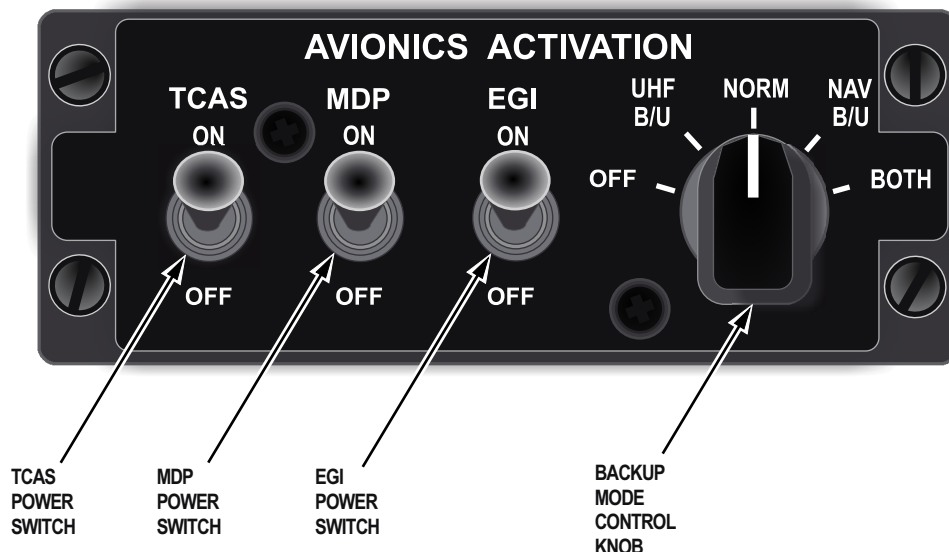

Figure 1-45. Avionics Activation Panel

T.O. 1T-38C-1 AVIONICS SYSTEMS

- a. Traffic Collision Avoidance System (TCAS).
- b. MDP.
- c. Embedded Global Positioning System / Inertial Navigation System (EGI).
- d. VOR/ILS radio, UHF radio, and VHF radio.

These switches do not replace the system circuit breakers. The AAP controls these systems regardless of the Take Command Switch position. The respective backup control panels (NAV/TACAN/UHF) must be turned on for AAP operational control as described above. Refer to BACKUP CONTROL PANELS, this section.



Over travel or vibration of the AAP MDP /TCAS / EGI power switches can result in an OFF condition and cause an equipment reboot. This can occur without activation of the respective switch.

AAP CONTROLS

TCAS Switch

The two-position TCAS switch, Figure 1-45, controls the TCAS and Identification Friend or Foe (IFF) transponder.

If the MDP is inoperative, the IFF transponder cannot be controlled and remains in its last setting before the MDP failure. Refer to IDENTIFICATION, FRIEND OR FOE (IFF)/TRAFFIC COLLISION AVOIDANCE SYSTEM (TCAS), this section.

MDP Switch

The two-position MDP switch, Figure 1-45, controls the MDP.

NOTE

The MDP generates and controls all displays on the HUD, UFCP, and normal display on the MFDs. If the MDP is turned OFF or is unavailable, there is no display on the HUD/UFCP and only a backup display on the MFD.

EGI Switch

The two-position EGI switch, Figure 1-45, controls the EGI, Radar Altimeter (RALT) and Yaw Stability Augmentation System (YSAS).

NOTE

EGI initialization does not occur until the EGI and MDP switches are ON and the MDP is operational.

Backup Mode Control Knob

The AAP Backup Mode Control Knob provides access to backup modes for the VOR/ILS and TACAN navigation radios (NAV Backup) and the UHF COMM radio (UHF Backup). In NAV or UHF Backup mode, control of the radio is switched from the MDP/UFCP to its backup control panel. Backup mode for all three radios is entered automatically when the MDP is off or has experienced total failure. The backup modes can be selected using the AAP Backup Mode Control Knob in the event of UFCP failure or when the MDP control of the radio is malfunctioning.

When in NAV Backup mode with the MDP operational, the MDP continues to display the backup mode navigation data on the HUD and MFD with only minor differences from normal displays, Refer to GROUND BASED NAVIGATION, this section. In NAV Backup mode, the UFCP NAVAID (BACKUP) Sub-Menu Display indicates NAV BACKUP.

The Backup Mode Control Knob selects the backup/normal control mode of the UHF radio and/or NAV (VOR/ILS and TACAN), and switches the VOR/ILS, UHF, and VHF OFF. The knob has the following positions:

- a. OFF - The VOR/ILS, UHF, and VHF are switched OFF. TACAN power is controlled only via the TACAN Backup Control Panel.
- b. UHF B/U - The UHF radio is controlled via the UHF Backup Control Panel. The NAV and the VHF radio are controlled by the MDP via the UFCP.
- c. NORM - The NAV/UHF/VHF systems are controlled by the MDP via the UFCP.
- d. NAV B/U - The VOR/ILS and TACAN are controlled via their backup control panel. The UHF and VHF are controlled by the MDP via the UFCP.

e. BOTH - The UHF radio and the NAV systems are controlled via their backup control panel. The VHF radio is controlled by the MDP via the UFCP.

NOTE

There is no backup control for the VHF COMM radio. If the MDP fails or is not operational, the VHF COMM radio remains on last tuned channel.

TAKE COMMAND SWITCH

The TAKE COMMAND Switch, located on the main instrument panel in the RCP, disables front cockpit control over avionics functions available on the MFD and UFCP when in the OVERRIDE position. With the TAKE COMMAND Switch in OVERRIDE, the following occur:

- a. FCP MFD receives RCP MFD displays.
- b. FCP MOSBs, UFCP keys, and UFCP OSBs are inoperative.
- c. FCP control stick Master Mode Switch (MMS) is inoperative.
- d. The MFD blanking function from either cockpit is deselected and disabled.

NOTE

The FCP HUD/UFCP ON/OFF switch, brightness controls, and NT/AUT/DAY switch are not affected by the position of the TAKE COMMAND Switch.

HANDS ON THROTTLE AND STICK (HOTAS)

To reduce aircrew workload, throttle and stick switches are used for control of simulated weapon delivery tasks, major avionics and non-avionics systems, and selection of avionics master modes. This allows operation of systems and functions while keeping the aircrew's hands on the throttles and the stick. See Figure 1-46

THROTTLE SWITCHES

Throttle switches are shown in Figure 1-46 and Figure 1-48.

Speed Brake Switch

The Speed Brake switch is a three-position switch. Refer to SPEED BRAKE SYSTEM, this section.

Microphone (MIC) Switch

The MIC Switch is a three-position switch spring loaded to the center position used to talk on the UHF/VHF radios. Refer to COMMUNICATION EQUIPMENT, this section.

Countermeasures Dispenser (CMD) Switch

The CMD switch is a three-position switch spring loaded to the center position and is used for simulated dispensing of chaff and flares. Refer to T.O. 1T-38C-34-1-1.

Weapon Mode Switch

The Weapon Mode Switch performs functions based on the selected master mode. In A/G Master Mode, the Weapon Mode Switch provides weapon-related functions. In A/A Master Mode it performs no function. Refer to T.O. 1T-38C-34-1-1. In NAV Master Mode, it is used to select TCAS modes. Refer to IDENTIFICATION FRIEND OR FOE (IFF) / TRAFFIC COLLISION AVOIDANCE SYSTEM (TCAS), this section.

STICK GRIP SWITCHES

Stick Grip switches are shown in Figure 1-46 and Figure 1-47.

Pitch And Roll Trim Button

Refer to FLIGHT CONTROL SYSTEM, this section.

Weapon Release (Pickle) Button

The pickle button is used to simulate release of A/A and A/G weapons. Refer to T.O. 1T-38C-34-1-1. It also initiates automatic VTR recording. Refer to VIDEO TAPE RECORDER (VTR), this section.

Master Mode Switch (MMS)

The MMS selects the avionics Master Modes. It is a four-position switch spring loaded to neutral. When the MDP is on, switch operation selects the avionics master modes as follows:

- a. FWD - A/A Master Mode. Refer to T.O. 1T-38C-34-1-1.
- b. AFT - A/G master mode. Refer to T.O. 1T-38C-34-1-1.
- c. DOWN - NAV master mode. Refer to NAVIGATION OVERVIEW, this section.

T.O. 1T-38C-1

AVIONICS SYSTEMS

The MMS can also be used to select the Range Scale on the MFD PFR and HSD Display Pages. Range scale is decremented on the selected display by re-commanding the current master mode; MMS forward when in A/A, MMS aft when in A/G, or MMS down when in NAV master mode. When the minimum range scale is selected, the next press of the MMS wraps to the maximum range scale. The Range Scale selection works independently in each cockpit.

If the MFD PFR Display Page is selected, the TCAS Range Scale will sequence as follows: 10, 5, 2.5, 20, 10.

If the MFD HSD Display Page is selected, the HSD Range Scale will sequence as follows: 30, 15, 120, 60, 30.

When the MDP is not available the MMS is disabled. The FCP MMS is disabled when the TAKE COMMAND Switch is in OVERRIDE.

Trigger

The trigger is a two-detent switch, The first detent starts automatic VTR recording. Refer to VIDEO TAPE RECORDER (VTR), this section. The second detent fires the simulated gun. Refer to T.O. 1T-38C-34-1-1.

Default Display Switch (DDS)

In both cockpits, pressing the DDS Switch for less than 1 second selects the PFR Display Page and deselects any blanking options. If displays are not in the repeater mode, pressing the DDS controls that cockpit's display only, first selecting PFR, then toggling to HSD. If PFR is already displayed, pressing

the DDS toggles the display to HSD. Pressing the DDS Switch again cycles between the PFR and HSD. If displays are in the repeater mode, pressing either cockpit DDS selects the PFR on both MFDs. If PFR is already displayed, pressing either cockpit DDS in repeater mode displays the HSD on both MFDs.

In the rear cockpit only, pressing and holding the DDS for greater than 1 second selects MFD HUD Display Page. Subsequent presses for greater than 1 second toggle between MFD PFR and HUD Display Pages. Pressing and holding the DDS for greater than 1 second does not terminate blanking options.

Nosewheel Steering (NWS) Switch

The NWS switch performs functions based on weight-on-wheels (WOW) status and selected Master Mode.

With WOW, in all Master Modes, the NWS switch provides nose wheel steering. Refer to NOSEWHEEL STEERING SYSTEM, this section.

With weight-off-wheels and in NAV Master Mode, the NWS switch is used to select the PNS. Pressing the NWS switch cycles through PNS selections, from left to right, as displayed along the top of the MFD. The PNS change will take effect only after the NWS switch has been released for greater than 3/4 of a second.

With weight-off-wheels and gear up, in A/G master mode, the NWS switch is used for target designation. With weight-off-wheels and gear up, in A/A master mode, the NWS switch commands simulated AIM-9 uncage. Refer to T.O. 1T-38C-34-1-1.

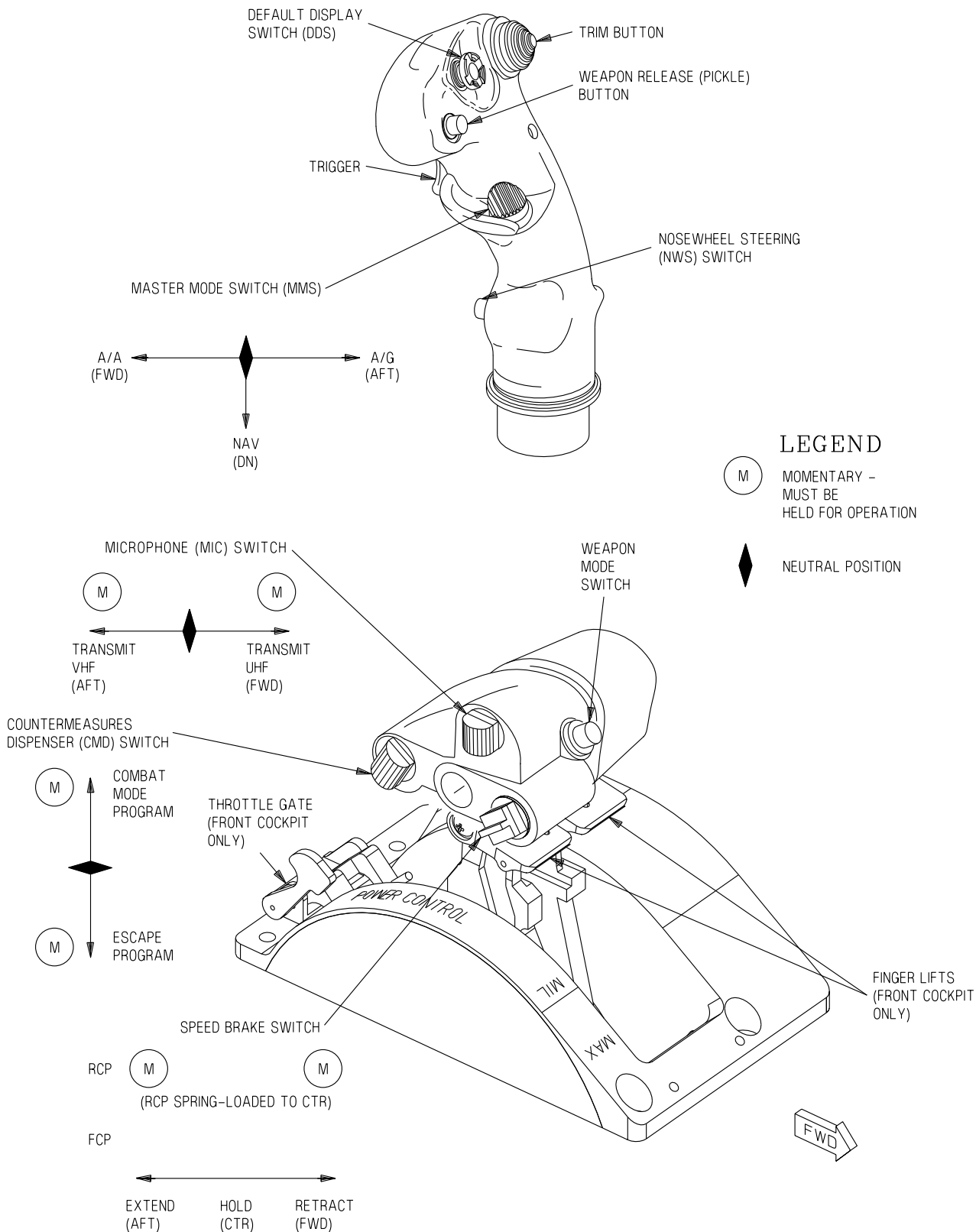

Figure 1-46. Stick Grip & Throttle Controls

T38002-4-1-021

**T.O. 1T-38C-1
AVIONICS SYSTEMS**

SWITCH	USE	SWITCH POSITION/ACTION			
		FWD	AFT	DOWN	
MMS		A/A	A/G	RANGE DECREMENT	
	NAV	A/A	A/G	NAV	
	A/A	RANGE DECREMENT	A/G	A/G	
	A/G	A/A	RANGE DECREMENT	A/G	
DDS (FCP)		DOWN < 1 SEC	DOWN > 1 SEC		
	WITHOUT BLANKING	PFR/HSD TOGGLE			
	WITH BLANKING	UNBLANK DISPLAYS AND PFR/HSD TOGGLE			
DDS (RCP)		DOWN < 1 SEC	DOWN > 1 SEC		
	WITHOUT BLANKING	PFR/HSD TOGGLE	HUD/PFR TOGGLE		
	WITH BLANKING	UNBLANK DISPLAYS AND PFR/HSD TOGGLE	HUD/PFR TOGGLE		
NWS	WOW	PRESS AND HOLD STEERING	PRESS AND RELEASE		
	WEIGHT-OFF-WHEELS, NAV		PNS ROTARY		
	WEIGHT-OFF-WHEELS, A/A		AIM-9 CAGE/UNCAGE TOGGLE		
	GEAR UP, WEIGHT-OFF-WHEELS, A/G		INITIATE TGT DESIGNATE		

Figure 1-47. Stick Grip Controls (Sheet 1 of 2)

SWITCH	USE	SWITCH POSITION/ACTION			
		1ST DETENT	2ND DETENT	RELEASE	
TRIGGER		VTR RUN	VTR RUN	STOP VTR	
	NAV, VTR STOPPED		FIRE GUN	STOP GUN FIRE	
	A/A OR A/G WEIGHT-OFF-WHEELS VTR STOPPED	VTR HUD	FIRE GUN/ VTR HUD	STOP GUN, VTR MFD AFTER 5 SEC	
	A/A OR A/G WEIGHT-OFF-WHEELS RECORDING MFD				
PICKLE		PRESS	RELEASE		
	NAV, VTR STOPPED	VTR RUN	STOP VTR		
	A/A OR A/G WEIGHT-OFF-WHEELS VTR STOPPED	WPN RELEASE			
	A/A OR A/G WEIGHT-OFF-WHEELS RECORDING MFD	WPN RELEASE/ VTR HUD	VTR MFD AFTER 5 SEC		
TRIM BUTTON		FWD NOSE DOWN	AFT NOSE UP	LEFT ROLL LEFT	RIGHT ROLL RIGHT

Figure 1-47. Stick Grip Controls (Sheet 2)

**T.O. 1T-38C-1
AVIONICS SYSTEMS**

SWITCH	USE	SWITCH POSITION/ACTION			
WPN MODE		PRESS AND RELEASE			
	NAV	TCAS TA/RA TOGGLE			
	MANUAL A/G	GUN/BOMB TOGGLE			
	CC MODE A/G	CCRP/CCIP/ GUN ROTARY			
	A/A	N/A			
COUNTER MEASURES DISPENSER (CMD)		UP	DOWN		
		COMBAT PRGM	ESCAPE PRGM		
SPEED BRAKE		AFT	CENTER	FWD	
		EXTEND	HOLD	RETRACT	
MIC		AFT VHF TRANSMIT	CENTER RECEIVE ONLY	FWD UHF TRANSMIT	

Figure 1-48. Throttle Controls

UP FRONT CONTROL PANEL (UFCP)

UFCP OVERVIEW

The UFCP, Figure 1-53, is used for control and display of navigation, communication, simulated weapon delivery, VTR, and other systems in both cockpits. Figure 1-54 and Figure 1-55 provides a summary of all menu, sub-menu and function key displays.

The UFCP accepts independent inputs from both cockpits and provides dependent display output to allow the aircrew to change functions with displays reflecting changes made by either cockpit. Refer to T.O. 1T-38C-34-1-1 for all weapon delivery related descriptions.

UFCP CONTROLS AND DISPLAYS

UFCP POWER SWITCH

The UFCPs (FCP and RCP), HUD, and HUD CTVS camera are turned ON/OFF via the FCP UFCP Power Switch (RCP UFCP Power Switch is non-functional). When the MDP is OFF, UFCPs, the HUD, and HUD CTVS camera are not operational. The FCP UFCP Power Switch, brightness controls, and the NT/AUT/DAY Toggle Switch (default brightness switch) are not affected by the position of the TAKE COMMAND Switch (located in RCP only). The MDP powerup default UFCP display is the Basic Menu Display, Figure 1-57.

UFCP/HUD DISPLAY BRIGHTNESS CONTROL

Display brightness of the UFCP and HUD are controlled by the following:

- a. NT/AUT/DAY Toggle Switch.

The UFCP and HUD display default brightness level is controlled by the FCP UFCP NT/AUT/DAY Toggle Switch, Figure 1-49. The RCP UFCP NT/AUT/DAY Toggle Switch is non-functional. When placed in the AUT (AUTO) position, a constant ratio between the brightness of the display and the outside world is maintained by a UFCP feature called Automatic Brightness Control (ABC). When the brightness of the outside surroundings increases, the brightness of the display is increased accordingly, and vice versa. The initial ratio between the brightness of the UFCP and HUD displays and the outside

world is determined by the setting of the U BRT and H BRT keys. Either DAY or AUT sets the day brightness level; AUT varies display brightness from day to night for the HUD as daylight illumination decreases; NT sets night brightness display. This switch is not affected by the position of the TAKE COMMAND Switch.



T38002-412-1-020

Figure 1-49. NT/AUT/DAY Toggle Switch

- b. UFCP U BRT Rocker Switch.

Display brightness of the UFCP display windows and VTR LED (FCP or RCP respectively) is controlled via the UFCP U BRT Rocker Switch, Figure 1-50. Brightness is increased from the default brightness level selected with the NT/AUT/DAY Toggle Switch by pressing the + (right) side and decreased by pressing the - (left) side of the rocker switch. This switch is not affected by the position of the TAKE COMMAND Switch.



T38002-412-2-020

Figure 1-50. UFCP U BRT Rocker Switch

- c. HUD H BRT Rocker Switch.

Display brightness of the HUD is controlled via the FCP UFCP H BRT Rocker Switch only, Figure 1-51. Brightness is increased from the default brightness level selected with the FCP UFCP NT/AUT/DAY Toggle Switch by pressing the + (right) side and decreased by pressing the - (left) side of the rocker switch. This switch is not affected by the position of

T.O. 1T-38C-1
UFCP

the TAKE COMMAND Switch.



T38002-412-3-020

Figure 1-51. HUD H BRT Rocker Switch

NOTE

The brightness of all UFCP keys and Option Select Buttons (OSB) are controlled via the INSTRUMENTS knob located on the lighting control panel on the right console.

UFCP DISPLAY WINDOWS AND OPTION SELECT BUTTONS (OSBs)

The UFCP display consists of four data windows, refer to DATA WINDOWS section of Figure 1-53. Each data window may contain up to eight alphanumeric/unique symbols. The data windows are numbered consecutively with the top data window being window 1, and the bottom data window being window 4. On both sides of each data window there is an OSB, used for selecting sub-menus, options or initiating data entry, as described later. The OSBs on the left side of the windows are referred to as UL-1 thru UL-4, from top to bottom. The OSBs on the right side are referred to as UR-1 thru UR-4, from top to bottom.

The action that the OSBs perform vary depending on what display is present on the UFCP and are described in more detail in FUNCTION KEYS, this section. The following elements are common to all UFCP displays unless specified otherwise:

- a. The name of the selected Function Key Display appears on the left side of window 1 (window 1L). The name does not appear on the Basic Menu Display or its various navigation sub-menus.
- b. A Function Key Display may consist of more than one page. The primary page is displayed at function selection. When additional data display or

entry is needed, a follow-on or secondary page can be accessed.

NOTE

If the current UFCP display is a sub-menu of a function key display, the first press of that functions UFCP key will access the initial function display. Pressing the same function key a second time returns the UFCP to the Basic Menu Display.

- c. Unique symbols that appear adjacent to the titles indicate the following:

~ Indicates the selected option can be toggled or is cyclic (when more than one is possible).

↓ Indicates a sub-menu page is selectable.

* Indicates the function is selected.

◇ Indicates selection is available for increment/decrement.

The following legend, Figure 1-52 is used to indicate the state of each OSB for the Figures in this section:

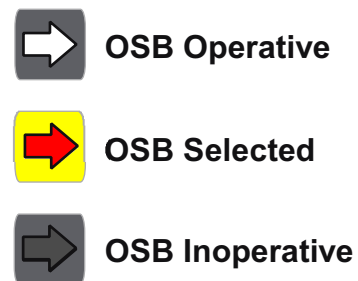

Figure 1-52. OSB Legend

T38002-414-1-020

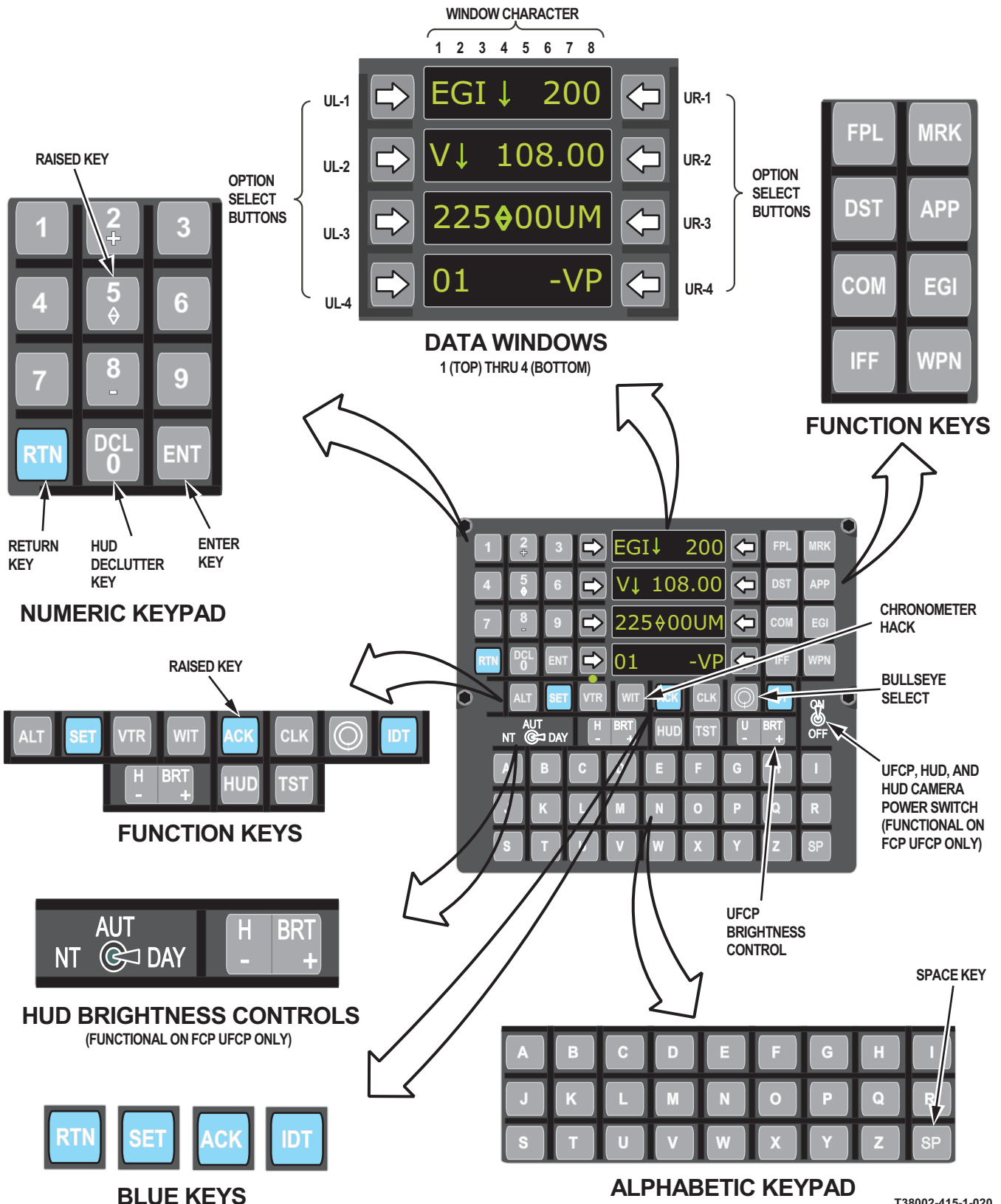

















Figure 1-53. UFCP Controls and Displays









T38002-415-1-020

SELECT NAV SUB-MENU DISPLAY		VOR↓ 261		SELECT EGI STEERPOINT/INOP SCA INC/DEC CAN BE SELECTED TO CHANGE STEERPOINT
SELECT NAVAID SUB-MENU DISPLAY TOGGLE FIP OR FNL FOR SCA		V↓116.40		SELECT FREQUENCY/BLANK SCA/INOP NAV B/U
SELECT UHF FREQ/CH/INOP GRD		256◇60UM		TOGGLE M/P/INOP GRD/UHF BKUP/RADIO INOP INC/DEC CYCLES BETWEEN LAST & CURRENT
SELECT VHF FREQ/CH/INOP GRD		11 ~VP		TOGGLE M/P/INOP GRD/RADIO INOP INC/DEC CYCLES BETWEEN LAST & CURRENT









BASIC MENU DISPLAY

SELECT NAV SOURCE SUB-MENU DISPLAY		VOR↓ ↓↑		SELECT BEARING ARROW SUB-MENU DISPLAY
LOAD APP DATA		APP* 501		SELECT APP NUMBER
TOGGLES AUT/MAN WAYPOINT SELECTION		AUT~ FPO		SELECT FP# (0-9)
TOGGLES FD ON/OFF		FD* CDM		TOGGLES CDM ON/OFF

NAV SUB-MENU DISPLAY

SELECT TACAN		TCN AAT		SELECT A/A TACAN
SELECT VOR		VOR LOC		SELECT LOC
SELECT ILS		ILS BC		SELECT BC
SELECT EGI		EGI SCA		SELECT SCA/INOP IF BLANK

NAV SOURCE SUB-MENU DISPLAY

SELECT EGI		EGI*		INOP
SELECT VOR		VOR*		INOP
SELECT TACAN		TCN*		INOP
INOP				INOP

BEARING ARROW SUB-MENU DISPLAY

Figure 1-54. UFCP Menu/Sub-Menu Displays (Sheet 1 of 2)



NAVAID SUB-MENU DISPLAY

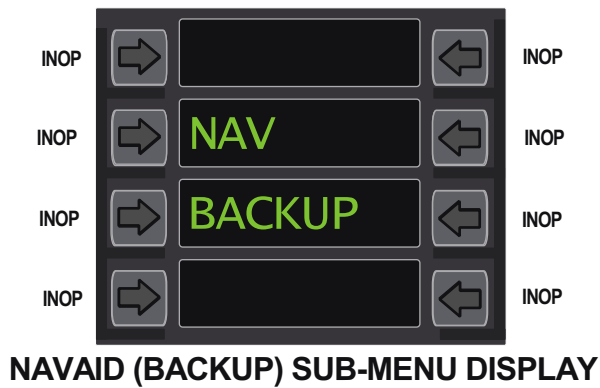

NAVAID (BACKUP) SUB-MENU DISPLAY

Figure 1-54. UFCP Menu/Sub-Menu Displays (Sheet 2)

T38002-413-2-020



FLIGHT PLAN (FPL) KEY DISPLAY



FLIGHT PLAN SUB-MENU DISPLAY

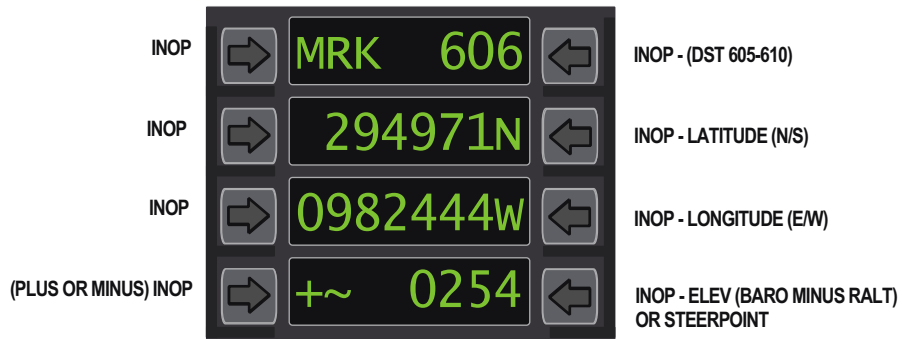

MARK (MRK) KEY DISPLAY



DESTINATION (DST) KEY DISPLAY (WGS)

Figure 1-55. UFCP Function Keys/Sub-Menu Displays (Sheet 1 of 6)

SELECT TOT SUB-MENU DISPLAY	→	DS↓ ↕236	←	ENTER DST NUMBER
ENTER ZONE	→	15S XC	←	ENTER 100KM BLOCK
ENTER X AND Y COORDINATES	→	38689502	←	INOP
TOGGLES +/-	→	+~ 285	←	ENTER MSL ALTITUDE

DESTINATION (DST) KEY DISPLAY (UTM)

INOP	→	DS ↕236	←	ENTER DST NUMBER
SELECT/DESELECT TOT	→	TOT*~WGS	←	TOGGLES WGS/UTM
SETS TOT (HH:MM:SS)	→	12:34:50	←	INOP
SELECT/DESELECT DVT	→	DVT*	←	INOP

TOT SUB-MENU DISPLAY

SELECT APP SUB-MENU DISPLAY	→	APP↓ ↕501	←	ENTER APP # (500-509)
INOP	→	0384492N	←	INOP
INOP	→	0902220W	←	INOP
INOP	→	+~ 0618	←	INOP

APPROACH (APP) KEY DISPLAY

INOP	→	114.80 V	←	INOP
INOP	→		←	INOP
INOP	→	003 CRS	←	INOP
INOP	→		←	INOP

APPROACH SUB-MENU DISPLAY (FOR NAVAID)

Figure 1-55. UFCP Function Keys/Sub-Menu Displays (Sheet 2)



APPROACH SUB-MENU DISPLAY (FOR SCA)



COMMUNICATIONS (COM) KEY DISPLAY



EMBEDDED GPS/INS (EGI) KEY DISPLAY



IFF/TCAS (IFF) KEY DISPLAY

Figure 1-55. UFCP Function Keys/Sub-Menu Displays (Sheet 3)



TCAS (TCS) SUB-MENU DISPLAY



IFF/TCAS (IFF) KEY DISPLAY (TCAS OFF)



WEAPONS (WPN) KEY DISPLAY



ALTITUDE (ALT) KEY DISPLAY

Figure 1-55. UFCP Function Keys/Sub-Menu Displays (Sheet 4)

T38002-569-4-020



SET (SET) KEY DISPLAY



VIDEO TAPE RECORDER (VTR) KEY DISPLAY



VTR KEY DISPLAY (VTR OFF)

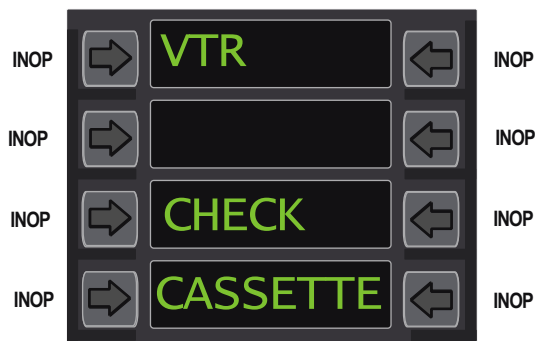

VTR KEY DISPLAY (NO TAPE OR END OF TAPE)

Figure 1-55. UFCP Function Keys/Sub-Menu Displays (Sheet 5)

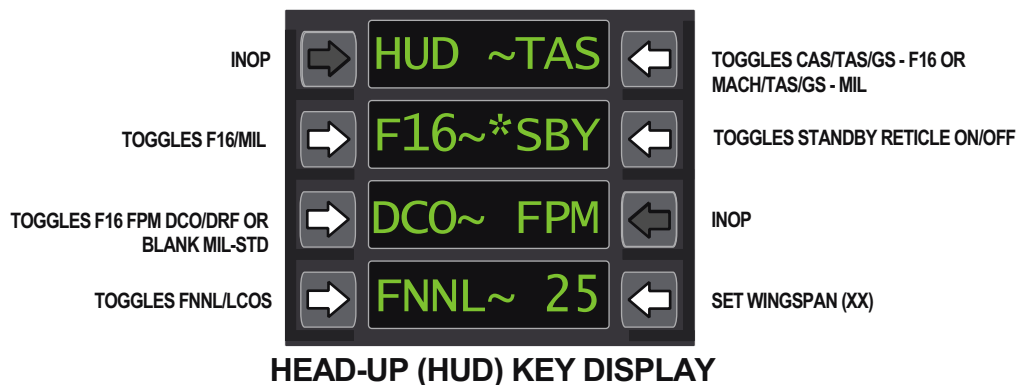
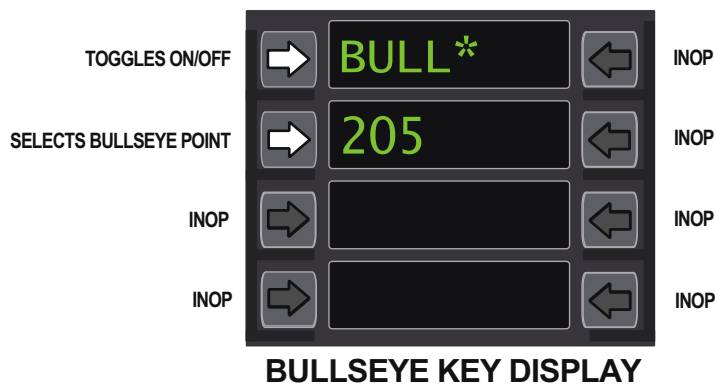
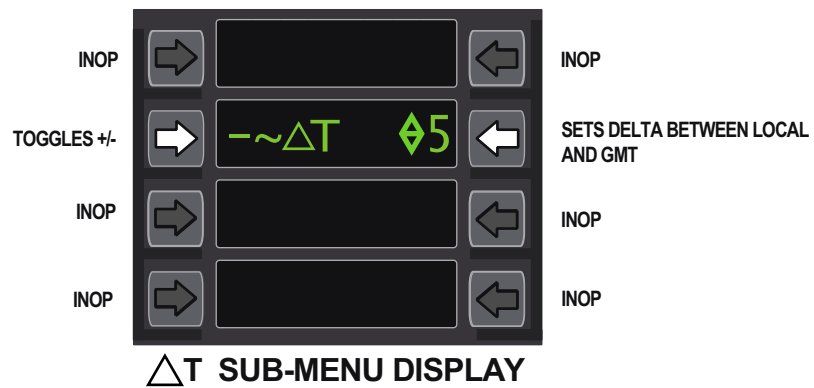
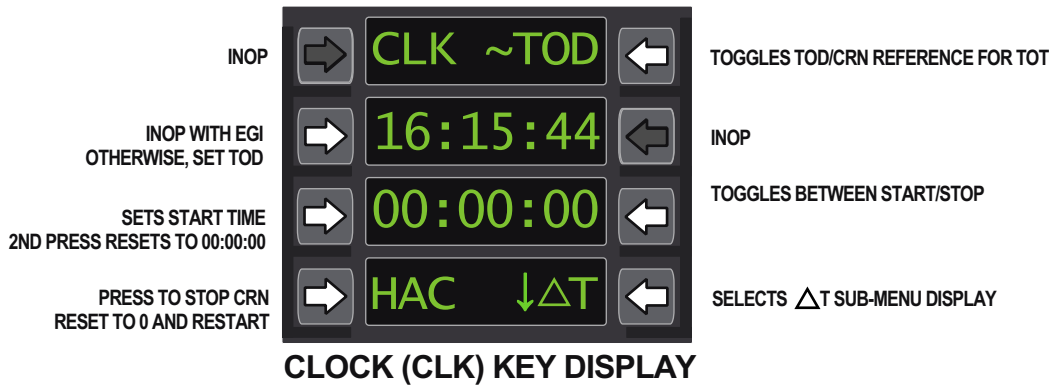

Figure 1-55. UFCP Function Keys/Sub-Menu Displays (Sheet 6)

T38002-569-6-020

T.O. 1T-38C-1 UFCP

NUMERIC KEYPAD

The numeric keypad, refer to NUMERIC KEYPAD section of Figure 1-53, includes the following:

- Digit keys (0-9) for numeric data entry.
- RTN Key returns the UFCP Function Key Displays to the Basic Menu Display. If the current page is a sub-menu display, RTN selects the previous page. If data entry is in progress, pressing RTN once returns the last valid data and remains on the same page.
- ENT Key (for accepting data).

A plus (+) sign is located on the digit 2 key, a minus (-) sign is located on the digit 8 key, and an increment/decrement (Inc/Dec) (\diamond) symbol is located on the 5 key. The 5 key is raised 1/8 inch taller than the other keys. The HUD declutter key (DCL) selection is located on the 0 key.

NOTE

Confusion may result from the RCP aircrew initiating HUD declutter options that affect the FCP pilot's displays without the FCP pilot's knowledge.

Numeric keys are operational only when the data entry function is initiated or when increment/decrement function is enabled.

ALPHABETIC KEYPAD

The alphabetic keyboard contains 27 keys, one for each letter A thru Z and a space (SP) key; refer to ALPHABETIC KEYPAD section of Figure 1-53. The keyboard is active during data entry which may require alphabetic entries; otherwise, it is non-functional except for programmed hot keys. Refer to HOT KEYS, this section.

UFCP DATA ENTRY

Data is entered by selecting the location for data entry (OSBs UL-1 thru UL-4 / UR-1 thru UR-4) on the selected function display, entering data via the appropriate keypad (numeric/alphabetic), and pressing the ENT Key if necessary.

NOTE

During data entry, the other cockpit's display is updated to display the data as it is entered, character by character.

CHANGING DATA VIA KEYPAD

An alphanumeric data field is changed by first pressing the OSB adjacent to the data to be updated. After pressing the OSB, the data field value is removed from the display and underscores (_) fill the data location (the number of underscores is equal to the maximum number of characters possible for that data location), refer to Figure 1-56.

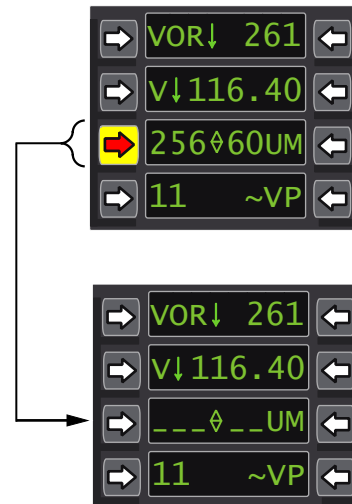

Figure 1-56. UFCP Data Entry Display

The corresponding data location on the other UFCP is replaced with blanks. Characters may then be entered via the keypad (numeric/alphabetic) on the UFCP where the OSB selection occurred (numeric/alphabetic keys of the other UFCP are not operational). Characters are displayed left to right as they are entered, with each character replacing the next underscore. Characters are also displayed left to right on the other UFCP as they are entered, with each character filling the next blank space. If the field requires only numeric data the alphabetic keyboard is inoperative. The alphabetic keyboard is only operative for the following displays:

- Basic Menu - window 1R
- Basic Menu - window 2R (X or Y for AAT/TCN)
- Navaid Sub-Menu - window 1L
- DST function menu (MGRS coordinate format)
- window 2R and 2L

- e. Bullseye Menu (double circle) - window 2L
- f. FPL function menu - window 2R

Data entry is completed by either entering all the required characters (as indicated by the underscores displayed) or by pressing the ENT Key.

When data entry is complete, the new data is subjected to a validity check. If the data is valid it is displayed steady and the MDP uses the new data (see VALIDITY CHECK, this section for details on the validity check for data entries that are required to be tuned). If the data is not valid, the data flashes and the MDP uses the last valid data until the error is corrected. The flashing on the UFCP ceases when either new data is entered or RTN is pressed. Pressing RTN displays the last valid entry. Pressing a function key while the UFCP is flashing, cancels the invalid entry and the UFCP goes to the newly selected display. Refer to ERRORS DURING UFCP OPERATION, this section.

EFFECTS OF KEY PRESSES DURING DATA ENTRY

Pressing other UFCP keys during data entry has the following effects:

- a. Pressing a functional nonadjacent OSB from either cockpit returns the data to its last valid value and performs the function of the OSB pressed.
- b. Pressing the adjacent OSB clears the current data field and re-initiates the data process for that field.
- c. Pressing a function key from either cockpit returns the last valid data and activates the newly selected function page.
- d. Pressing IDT, WIT (hack), ACK, and the HUD/UFCP brightness controls from either cockpit performs those key functions without affecting data entry or the UFCP displays.
- e. Pressing the TST Function Key illuminates all the UFCP windows in that cockpit with the test display then returns to the page displayed previous to the TST Key selection when the key is released. Data entry is not affected.
- f. Pressing keys on the alphabetic keyboard from either cockpit during numeric data entry has no effect. The alphabetic keypad keys are inoperative

during data entry with fields requiring only numeric data.

g. Pressing the RTN Key from either cockpit returns the last valid data and remains on the same page.

h. During data entry in one cockpit, pressing the corresponding OSB in the other cockpit display clears the current data field and initiates the data process for that data field in the other cockpit.

NOTE

For ease of identification, the Return (RTN), Set (SET), Acknowledge (ACK), and Ident (IDT) keys are a blue-grey color.

INCREMENT/DECREMENT

The Increment/Decrement (◊)(Inc/Dec) function is used to increment or decrement numerical fields in the following UFCP displays:

Basic Menu Display

- a. Steerpoint - Window 1R
- b. UHF Preset - Window 3L
- c. UHF Manual Frequency - Window 3L (manual frequency recall)
- d. VHF Preset - Window 4L
- e. VHF Manual Frequency - Window 4L (manual frequency recall)

SET Key Display

- a. Speed bug (green and yellow) - Window 3L
- b. Bingo Setting - Window 4L

ALT Key Display

- a. QNH - Window 2R

FPL Key Display

- a. Waypoint number - Window 2L

FPL Sub-Menu Display

- a. Waypoint number - Window 2L

DST Key Display

- a. Dest point number - Window 1R

T.O. 1T-38C-1

UFCP

TOT Sub-Menu Display

- a. Dest point number - Window 1R

COM Key Display

- a. Preset number - Window 2L (both UHF and VHF)

APP Key Display

- a. Approach numbers - Window 1R

ΔT Sub-Menu Display

- a. Clock Delta Time- Window 2R

Inc/Dec is performed according to the following rules:

- a. Inc/Dec is operable in only one field at a time. The operable field is marked by the presence of the (◊) symbol. When the (◊) symbol is displayed on a field, pressing the 2 key causes the field to increment; pressing the 8 key causes the field to decrement.

- b. The (◊) symbol can be moved from one field to another on the Basic Menu Display and the SET Key Display only. Pressing the 5 key on the numeric keypad, while no field is open for data entry, moves the Inc/Dec symbol from one field to another. Pressing the 5 key on any other menu/sub-menu with an Inc/Dec symbol, other than the Basic Menu Display or the SET Key Display, has no effect on the Inc/Dec symbol. Details of Inc/Dec functionality on the Basic Menu Display and the SET Key Display are as follows:

Basic Menu Display

On the Basic Menu Display, the (◊) symbol moves in the following sequence: Window 3L → 4L → 1R → 3L, etc. The location of the (◊) symbol defaults to Window 3L on MDP powerup and remains in the field last selected after leaving and returning to the Basic display. When the steerpoint (Window 1-R) is an ICAO, the (◊) is removed and is not displayed on another field unless moved by the 5 key. When the UHF radio is off upon MDP start-up, the (◊) symbol is not displayed. The (◊) symbol appears in the next window location in the sequence when the 5 key is pressed. Inc/Dec for UHF (Window 3L) and VHF (Window 4L) is not operable if the radio is OFF or in GRD.

Set Key Display

On the SET Key Display, the (◊) symbol moves in the following sequence: Window 3L → 4L → 3L, etc. The location of the (◊) symbol defaults to Window 3L on MDP powerup and upon every selection of the SET Key Display.

If Inc/Dec is not functional on the desired field, the (◊) is not displayed on the field. Inc/Dec is not operable in the following cases:

- a. Basic Menu Display - Steerpoint (Window 1R): When the steerpoint is an ICAO, the (◊) is removed and is not displayed on another field unless moved by the 5 key.

- b. Basic Menu Display - UHF Preset/Manual (Recall) (Window 3L): Inc/Dec is not operable when UHF radio is OFF or in GRD mode.

- c. Basic Menu Display - VHF Preset/Manual (Recall) (Window 4L): Inc/Dec is not operable when VHF radio is OFF or in GRD mode.

- d. COM Key Display - UHF or VHF (Window 2L): Inc/Dec is inoperative if radio is OFF.

VALIDITY CHECK

When the last character of new data is entered, the new data flashes while undergoing a validity check. The existing data is retained until the validity check is successful. The data entered is checked to ensure it falls within the allowable parameters for that field. If the new data is not required to be tuned, as in a radio frequency, the validity check is complete and the new data replaces the existing data and stops flashing. If the new data is not within the allowable parameters and continues to flash, the existing data is retained. Refer to ERRORS DURING UFCP OPERATION, this section.

For data that is required to be tuned, the validity check is not complete until the new data is successfully tuned into the transmitter/receiver. The process is different for immediate tuning versus delayed tuning and functions as follows:

- a. If the data is being entered into an active transmitter/receiver, the tuning check occurs immediately and, if successful, the validity check is complete.

b. If the new data is not tuned immediately, as in the case of changing an ILS frequency when VOR is selected (via the NAVAID Sub-Menu Display or by selecting an ILS preprogrammed approach on the NAV Sub-Menu Display), the tuning check is not accomplished until the data is selected for use as the PNS. Assuming the data is within the allowable parameters for that field; it is accepted during the initial portion of the validity check and replaces the previous data. The new data is then displayed on the NAVAID Sub-Menu Display and on the MFD NAV data block as available for use. When selected as the PNS, the tuning check is accomplished. If the frequency fails to tune at that time, the frequency flashes on the UFCP and MFD until a valid frequency is entered or the aircrew selects another valid PNS.

NOTE

When entering data in an UFCP window, if the data entry window blanks or a valid entry is not accepted, press the RTN Key and reenter data.

ERRORS DURING UFCP OPERATION

The following error types may occur during operation:

- a. Inoperative OSB is pressed: No effect on the display when no data entry is active; Cancels data entry when data entry is active.
- b. Incorrect character is typed: System does not perform a validity check until all data is entered or the ENT Key is pressed where required.
- c. Invalid data is entered: Entered data flashes during the validity check. The last valid data is retained in the MDP until the error is corrected.

Error correction can be performed during data entry or when data is not valid by the following:

- a. Pressing the adjacent OSB: All characters clear and dashes are re-displayed in the data field.
- b. Pressing the RTN Key: The first press returns the last valid data. Subsequent presses step back up to the Basic Menu Display.
- c. Pressing another function key: The last valid data is returned for the data field and the respective function key display is selected.

UFCP BASIC MENU DISPLAY

The UFCP Basic Menu Display, Figure 1-57, is used for navigation and communications control in flight; it is the highest menu level display on the UFCP. The Basic Menu Display is the default display upon powerup, and is selected by pressing the RTN Key from any of the navigation sub-menus or function key displays. Depending on the current menu or sub-menu in use, it can take more than one actuation of the RTN Key to get to the Basic Menu Display.



T38002-417-1-021

Figure 1-57. UFCP Basic Menu Display

The Basic Menu Display is used for the following functions:

PNS Display

The PNS displayed at Window 1L matches the PNS boxed on the MFD at MT-2 thru MT-6 and the one asterisked on the NAV Source Sub-Menu Display. Display options include the following:

- a. Window 1L displays EGI↓, VOR↓, TCN↓, ILS↓, LOC↓, BC↓, or SCA↓, if four or fewer characters are required in window 1R to display the steerpoint.
- b. Window 1L is shortened to EG↓, VO↓, TC↓, IL↓, LO↓, or BC↓, if five characters are required in window 1R.

Selection Of The Nav Sub-Menu Display

Pressing UL-1 selects the Nav Sub-Menu Display. Refer to NAV SUB-MENU DISPLAY, this section.

T.O. 1T-38C-1
UFCP

Steerpoint Display And Update

The Basic Menu Display is the primary means of selecting EGI steerpoints. Window 1R displays the steerpoint in one of the following forms:

a. Waypoints are displayed as F-WW, with the F representing the flight plan number, Figure 1-58, and the WW representing the waypoint number. Valid flight plans are 0 - 9 and valid waypoint numbers are 00 - 15.



T38002-576-1-020

Figure 1-58. UFCP Basic Menu Display

b. Destination points are displayed as a three-digit number, Figure 1-59. Valid entries are 200-509 and 600-610.



T38002-418-1-020

Figure 1-59. UFCP Basic Menu Display

c. ICAO points are displayed as a 2-5 digit alphanumeric value, Figure 1-60. Valid entries are any ID values of a point loaded via the ICAO file.

Pressing UR-1 clears the steerpoint displayed at window 1R and enables data entry. A new steerpoint can be entered as follows:

- a. Waypoint - 1 or 2 numeric digits
- b. Destination Point - 3 numeric digits
- c. ICAO Point - 2 to 5 alphanumeric digits followed by a space then the group letter; W = Waypoint, N = Navaid, A = Airport (space and group letter not required)

A steerpoint entry is accepted by pressing the ENT Key when the desired characters have been entered, or automatically after the seventh character is entered. Pressing ENT Key after entering an invalid steerpoint causes window 1R to blink. Pressing RTN Key reverts back to the current steerpoint. If an ICAO point is entered without a corresponding group letter the MDP selects a point from the mission-planned ICAO file in the following order of corresponding group types:

- a. Navaid
- b. Waypoint
- c. Airport

ICAO POINT AS STEERPOINT



T38002-419-1-020

Figure 1-60. UFCP Basic Menu Display

UR-1 is inoperative when SCA is the selected NAV source. The default steerpoint display upon MDP powerup is destination point 200.

Display And Update Of Navigation Source Tuning

Pressing UR-2 clears the frequency/channel displayed at window 2R and enables data entry.

a. Frequency entry can be completed by entering all 5 digits or by selecting ENT after a minimum of 3 digits (digits not entered assumed to be zero).

b. Channel entry can be completed by entering all 3 digits and X/Y or by selecting ENT after any digit (leading zeros and X are assumed).

Window 2 displays the navigation source (VOR, TCN or ILS) and associated commanded frequency/channel as follows:

a. V↓ is displayed at window 2L and the VOR frequency is displayed at window 2R when either EGI or VOR is selected as the PNS.

b. I↓ is displayed at window 2L and the ILS frequency is displayed at window 2R when ILS, LOC, or BC is selected as the PNS.

c. T↓ is displayed at window 2L and the A/G TACAN channel is displayed at window 2R when TCN is the PNS and AAT is not selected.

d. A↓ is displayed at window 2L and the A/A TACAN channel is displayed at window 2R when TCN is the PNS and AAT is selected.

NOTE

- If SCA is the selected navigation source in window 1L: Window 2R is blank and pressing UL-2 toggles window 2L between ~FIP and ~FNL; ~FIP is the default.
- If the AAP Backup Mode Control Knob is in NAV B/U or BOTH, Window 2R displays the actual frequency/channel as tuned via the NAV and TACAN Backup Control Panels and UR-2 is inoperative.
- If the receiver is inoperative: OFF is displayed in window 2 and UR-2 is inoperative.

Selection Of The Navaid Sub-Menu Display

Pressing UL-2 displays the Navaid Sub-Menu Display when SCA is not the selected PNS in window 1L (refer to NAVOID SUB-MENU DISPLAY, this section).

Display And Update Of UHF And VHF Radio Frequencies

UHF and VHF radio frequency selections are displayed in the form of manual frequency values or

preset channels. Window 3 displays the UHF radio frequency and window 4 displays the VHF frequency. OFF is displayed if the UHF or VHF radio is off or not communicating. GRD is displayed if selected via the Com Key Display. Each frequency is displayed as follows:

a. Manual frequency value: Window 3/4 displays a 5 character frequency value on the left side of the window and UM for UHF and VM for VHF on the right side.

b. Preset channel: Window 3/4 displays a 2 character preset channel on the left side of the window and ~UP for UHF and ~VP for VHF on the right side.

Pressing UR-3 or UR-4 toggles window 3 or window 4 between the manual frequency setting (UM for window 3 and VM for window 4) and the preset channel setting (~UP for window 3 and ~VP for window 4), Figure 1-61.

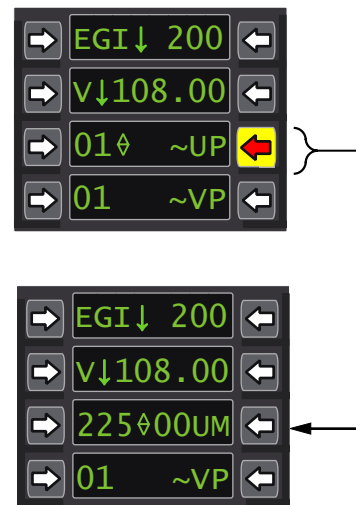

T38002-423-1-020

Figure 1-61. UHF Radio Frequency Update

Pressing UL-3 or UL-4 initiates data entry for window 3L or window 4L to allow entry of a manual frequency or a preset value, depending on the setting currently displayed (UM or UP). Frequency entry can be completed by entering all 5 digits or by selecting the ENT Key after a minimum of 3 digits (digits not entered assumed to be zero).

Valid entries for UHF/VHF frequencies are in five digits (###.##) as follows:

a. First three digits: UHF - 225 thru 399; VHF -118 thru 151.

T.O. 1T-38C-1

UFCP

- b. Fourth digit: 0 thru 9.
- c. Fifth digit: 0, 2, 5, 7.
- d. Sixth digit (0 or 5) is not entered.

Inc/Dec capability is available for the manual frequency display and the preset channel display. The Inc/Dec (◊) symbol on the preset channel display is located to the right of the preset value. Pressing keypad buttons 2/+ or 8/- increments or decrements to the next preset after the validity check. The Inc/Dec symbol on the manual frequency display is displayed in the place of the decimal point in the middle of the frequency value. Manual frequency recall uses the same mechanization as Inc/Dec, but its operation is different. Every time a manual frequency is tuned via the UFCP, the previous manual frequency is internally stored. Pressing keypad buttons 2/+ or 8/- recalls the previous manual frequency.

NAV SUB-MENU DISPLAY

The NAV Sub-Menu Display, Figure 1-62 is used for the following functions:

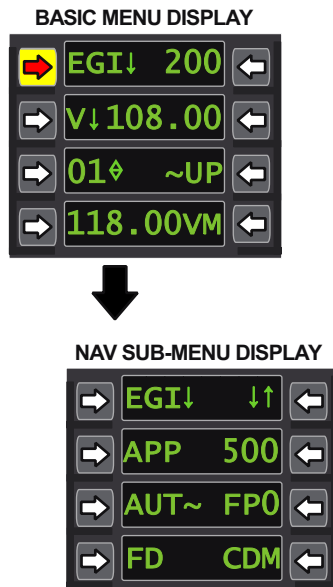

T38002-480-1-020

Figure 1-62. NAV Sub-Menu Display

Selecting The NAV Source Sub-Menu Display

Window 1L displays the current PNS; EGI↓, VOR↓, TCN↓, ILS↓, LOC↓, BC↓, or SCA↓. The PNS can be changed via the UFCP NAV Source Sub-Menu Display which is selected by pressing UL-1 on the NAV

Sub-Menu Display. Refer to the NAV SOURCE SUB-MENU DISPLAY, this section.

Selecting The Bearing Arrow Sub-Menu

The Bearing Arrow Sub-Menu is selected by pressing UR-1 on the NAV Sub-Menu Display. Refer to the BEARING ARROW SUB-MENU DISPLAY, this section.

Selecting/Enabling A Preprogrammed Approach

The default approach is 500. Pressing UR-2 enables data entry of a new preprogrammed approach point. Valid entries are 500 - 509. Pressing UL-2 enables the approach point by setting it as the steerpoint and putting an asterisk next to APP.

NOTE

The selected approach can only be disabled by entering a PPA DEST point different than the one currently entered in window 2R by pressing UR-2 and entering the 3 digit PPA (500 thru 509) or by changing the steerpoint on the Basic Menu Display.

Selecting Automatic Or Manual Waypoint Sequencing

Pressing UL-3 toggles window 3L between AUT~ and MAN~; default at powerup is AUT~.

Selecting The Desired Flight Plan

Pressing UR-3 enables data entry of a new flight plan. Valid entries for flight plans are values 0-9. The powerup default flight plan is the last selected. Changing the flight plan at UR-3 also changes the flight plan at window 1R of the FPL Key Display.

Selecting the FD Function

Pressing UL-4 activates/deactivates the flight director. An asterisk displays next to FD in window 4L when activated (FD*) and is removed when deactivated (FD). FD is boxed/unboxed at MT-1 on the MFD when FD is activated/deactivated.

Selecting The CDM

Pressing UR-4 activates/deactivates the display of the CDM on the MFD ADI (replacing the waterline symbol). An asterisk displays next to CDM in window 4R (*CDM) when activated and is removed when deactivated (CDM).

NAVAID SUB-MENU DISPLAY

The NAVAID Sub-Menu Display, Figure 1-63 is used for the following functions:

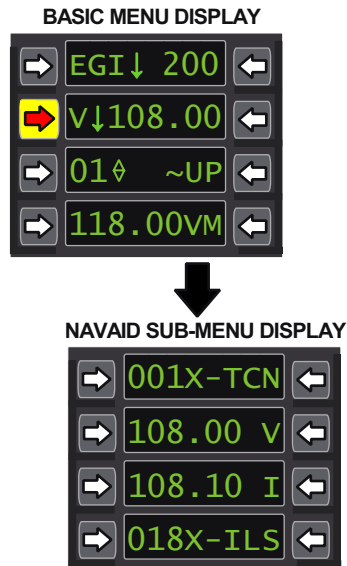

T38002-420-1-020

Figure 1-63. NAVAID SUB-Menu Display

TACAN Channel Entry

UR-1 toggles between TCN and AAT to allow display and editing of A/G TACAN channel or A/A TACAN channel respectively. The window defaults to TCN when the NAVAID Sub-Menu is selected. Pressing UL-1 allows the TACAN channel to be changed via the numeric/alphanumeric keypads. Channel entry can be completed by entering all 3 digits and X/Y or by selecting the ENT Key after any digit (leading zeros and X/Y are assumed). When the TACAN is off or not communicating, window 1 displays OFF and UL-1 and UR-1 are inoperative.

VOR Frequency Entry

Pressing UL-2 allows changing of the VOR frequency via the keypad. Frequency entry can be completed by entering all 5 digits or by selecting the ENT Key after a minimum of 3 digits (digits not entered assumed to be zero). When the VOR/ILS is off or not communicating, window 2 displays OFF and UL-2 is inoperative.

ILS Frequency Entry

Pressing UL-3 allows the ILS frequency to be changed via the keypad. Frequency entry can be completed by entering all 5 digits or by selecting the

ENT Key after a minimum of 3 digits (digits not entered assumed to be zero). When the VOR/ILS is off or not communicating, window 3 displays OFF and UL-3 is inoperative.

ILS Range Source Selection

Pressing UR-4 allows ILS range source selection (TCN or ILS). Selecting TCN sets the ILS range source to the A/G TACAN channel displayed in window 1L. Selecting ILS sets the ILS range source to the auto paired DME channel. When the TACAN is off or not communicating, window 4 displays OFF and UL-4 is inoperative. When the VOR/ILS is off or not communicating, pressing UR-4 toggles between ILS and TCN as usual. The ILS channel displayed in window 4 corresponds to the last ILS frequency that was entered in window 3.

NAVAID (BACKUP MODE) SUB-MENU DISPLAY

Refer to BACKUP CONTROL PANELS, this section.

NAV SOURCE SUB-MENU DISPLAY

The NAV Source Sub-Menu Display, Figure 1-64 is used for the following function:

PNS Selection

Pressing the desired OSB on the Nav Source Sub-Menu Display selects the PNS: TCN (UL-1), VOR (UL-2), LOC (UR-2), ILS (UL-3), BC (UR-3), EGI (UL-4), UR-4 selects SCA when available. An asterisk next to the NAV Source indicates the current selected PNS. When a new selection is made, the UFCP reverts back to the Nav Sub-Menu Display and the newly selected PNS is boxed on the MFD.

AAT (UR-1) is selected or deselected independent of PNS. AAT has an asterisk in window 1 of the Nav Source Sub-Menu display whenever AAT mode is selected.

BEARING ARROW SUB-MENU DISPLAY

The Bearing Arrow Sub-Menu Display, Figure 1-65 is used for the following function:

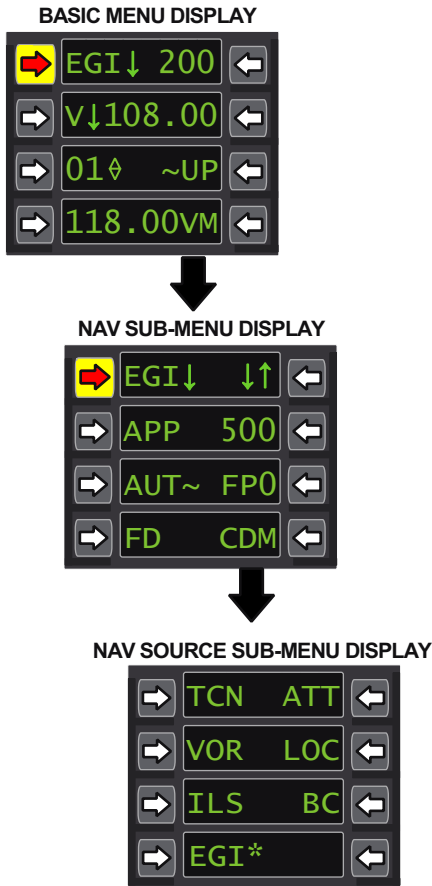

T38002-421-1-020

Figure 1-64. NAV Source Sub-Menu Display

Bearing And Range Display Selections

The Bearing Arrow Sub-Menu Display is used to select/deselect the bearing arrows and ranges to be displayed for secondary navigation sources. The bearing arrows and ranges for the PNS are displayed regardless of selection/de-selection on the Bearing Arrow Sub-Menu Display. All bearing arrows default to selected at powerup. An asterisk following the displayed source (EGI/VOR/TCN) indicates that it is selected for display on the MFD.

UFCP FUNCTION KEYS

Most UFCP keys select a display for control of a specific function, while other keys specifically activate a function. Each UFCP function key is labeled with the name of the function it controls. The UFCP function keys (Figure 1-53) are as follows:

- a. Altitude (ALT)
- b. Set (SET)

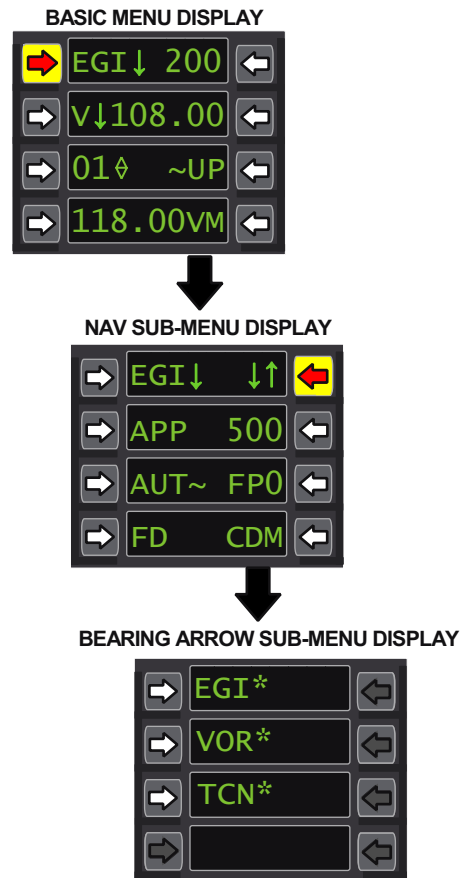

T38002-422-1-020

Figure 1-65. Bearing Arrow Sub-Menu Display

- c. Video Tape Recorder (VTR)
- d. Witness (WIT)
- e. Acknowledge (ACK)
- f. Head-Up Display (HUD)
- g. Declutter (DCL)
- h. Clock (CLK)
- i. Display Test (TST)
- j. Bullseye (double circle)
- k. Ident (IDT)
- l. Flight Plan (FPL)
- m. Destination (DST)
- n. Communication (COM)
- o. Identification Friend Or Foe (IFF)
- p. Mark (MRK)
- q. Approach (APP)
- r. Embedded GPS/INS (EGI)
- s. Weapons (WPN)

When a function key is first pressed, the function's primary page is displayed. A UFCP function display may be exited anytime by either of the following:

- Pressing another UFCP function key displays newly selected function's primary display page.
- Pressing the same function key a second time returns UFCP to the Basic Menu Display.
- Pressing the RTN Key returns UFCP to the Basic Menu Display.

ALTITUDE (ALT) FUNCTION KEY

Pressing the ALT Function Key activates the ALT Key Display, Figure 1-66, which is used for the following functions:

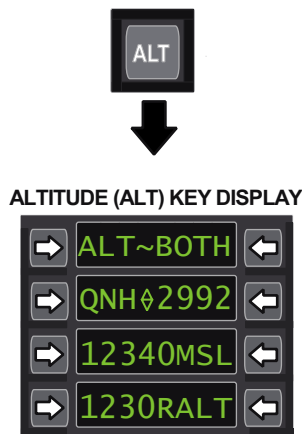

T38002-424-1-020

Figure 1-66. Altitude (ALT) Function Key

Selection Of The Altitude Warning Data Sources

Pressing UR-1 allows selection of the data source (BOTH, MSL, RALT, or OFF) for activation of the altitude warnings for all avionics modes. This selection determines whether the altitude settings in window 3L (MSL) and window 4L (RALT) are used for ALT warning activation. The MDP powerup default is BOTH.

Setting The Altimeter

Setting the altimeter is accomplished by using the Inc/Dec or by data entry via UR-2. Window 2R displays the barometric pressure in inches of Mercury (Hg) in four digits (decimal point is not displayed but assumed between the second and third digits of the entry). The initial altimeter setting at MDP powerup

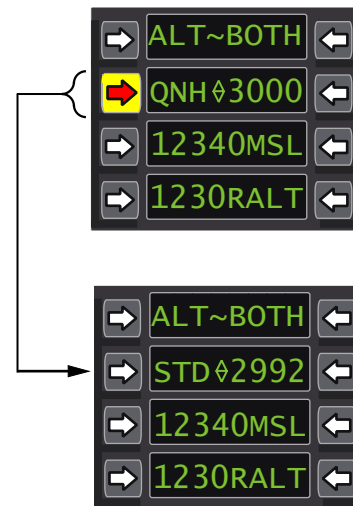

T38002-425-1-020

Figure 1-67. QNH Barometric Pressure Selection

is last set. Altimeter settings less than 27.00 and greater than 31.00 are invalid. If Inc/Dec is used, selecting a value less than 27.00 displays 3100 and selecting a value greater than 31.00 displays 2700. The Inc/Dec interval for QNH is 0.01 inches of Mercury. Incrementing while STD is displayed results in QNH being displayed with a value set to 2993. Decrementing, while STD is displayed, results in QNH being displayed with a value set to 2991. Selecting UL-2, Figure 1-67, or the Q Hot Key on the alphanumeric keypad toggles window 2 between QNH (◇) XXXX and STD (◇) 2992, where XXXX represents a QNH value between 27.00 and 31.00. Refer to HOT KEYS, this section.



Inadvertent pressing of the Q Hot Key can only be detected by referencing the altimeter display on the MFD or selecting the UFCP ALT Key Display.

T.O. 1T-38C-1 UFCP

Setting The Minimum Altitude For Activation Of The Altitude Warning For MSL and RALT

The altitude warning is available in all avionics modes. Window 3L displays the MSL altitude warning activation altitude and window 4L displays the RALT altitude warning activation altitude. Pressing UL-3 and UL-4 initiates new data entry for window 3L and window 4L. Leading zeros can be entered, but are not displayed. The MSL setting can be entered up to a 5-digit altitude in feet MSL; the last digit entered must be a zero (####0), with valid numbers from 0 to 50000. The RALT setting can be entered up to a 4-digit altitude in feet AGL; the last digit entered must be a zero (###0) with valid numbers from 0 to 5000. The MDP powerup default are the values from the last DTC load.

SET FUNCTION KEY

Pressing the UFCP SET Function Key activates the Set Key Display, Figure 1-68, which is used for the following functions:

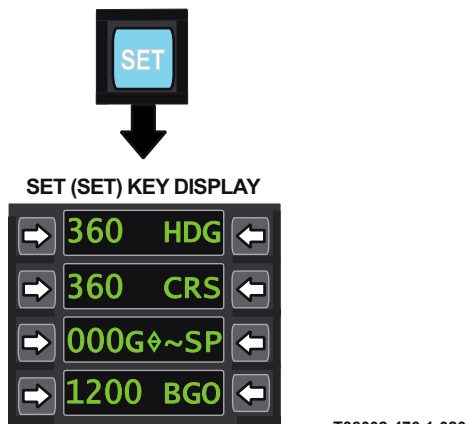

Figure 1-68. Set Function Key Display

Setting The Heading Set Marker

Window 1L shows the selected heading in 3-digits with leading zeros. Pressing UL-1 enables data entry of a new heading for the heading set marker (001 thru 360). This function works in parallel with the MFD HDG Set Marker Rocker Switch. The MDP powerup default is the last selected. Pressing UR-1 once changes the selected heading to the current aircraft heading (digits change and HDG blinks). UR-1 must be pressed a second time within 5 seconds to keep the change. If UR-1 is not pressed a second time within 5

seconds, the HDG setting reverts to the previous value.

NOTE

Aircraft heading is always magnetic.

Setting The Selected Course

Window 2L shows the selected course in 3-digits with leading zeros. Pressing UL-2 enables data entry of a new course (001 thru 360). This function works in parallel with the MFD CRS Rocker Switch and is inoperative when SCA is the PNS. The MDP powerup default is the last selected. Pressing UR-2 once changes the selected course to the current aircraft heading (digits change and CRS blinks). UR-2 must be pressed a second time within 5 seconds to keep the change. If UR-2 is not pressed a second time within 5 seconds, the CRS setting reverts to the previous value. UR-2 is inoperative when SCA is the PNS.

Setting Commanded Airspeed Indicator

With gear up, window 3L displays the current manually commanded airspeed (speed bug) setting in knots with leading zeros (000 thru 999). Pressing UR-3, Figure 1-69, toggles between G speed (green MFD tic mark/F-16 HUD manually commanded speed caret/MIL-STD HUD commanded airspeed indicator) and Y speed (yellow MFD tic mark).

Pressing UL-3 enables data entry of a new 3-digit bug speed setting (green or yellow) in knots. The Inc/Dec interval for airspeed bug values is 1-knot when used. When the G speed is set as the active display in Window 3, the Y speed is automatically set to 20 knots greater than the G speed. If the Y speed is set in the active display in Window 3, the G speed is not affected. MDP powerup default is last selected for G speed and Y speed is set to 20 knots greater than G speed.

With gear down, the auto mode approach speed (A speed) mark is an automatically calculated green final approach speed based on flap position and fuel remaining. When the speed bug transitions to auto mode, window 3L is automatically updated with the A speed. This mode is available only with weight off wheels, gear down and valid fuel quantity for both tanks. The Y speed is set to 20 knots greater than the A speed.

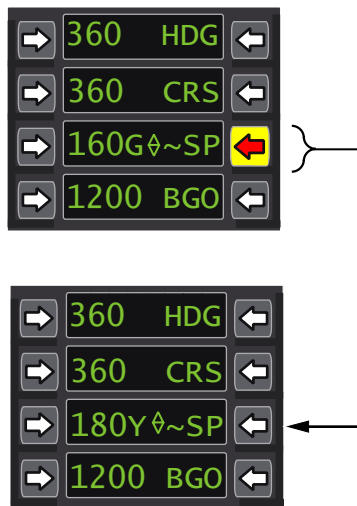

T38002-427-1-020

Figure 1-69. Commanded Airspeed Indicator

The speed bug switches to auto mode (A) under any of the following situations:

- The gear goes down.
- The flaps move past 50% (22°) mark in either direction with weight off wheels and gear down.

NOTE

There is approximately 2 seconds delay between the flap indicator 50% reading and the Auto Speed Bug Flap/No Flap trigger point.

- The mode is changed to auto (A) via the UFCP Set Key Display with gear down.
- The gear is still down 60 seconds after weight off wheels.

The speed bug switches from auto (A) to manual (G) under any of the following situations:

- The gear comes up.
- The mode is changed to manual (G) via UR-3 with gear down, Figure 1-70.
- The speed bug is modified via INC/DEC on the UFCP Set Key Display.
- The speed bug is modified via data entry (UL-3) on the UFCP Set Key Display.
- The aircraft has WOW.

When the speed bug switches from auto (A) to manual (G), the manual (G) speed bug defaults to the last auto setting.

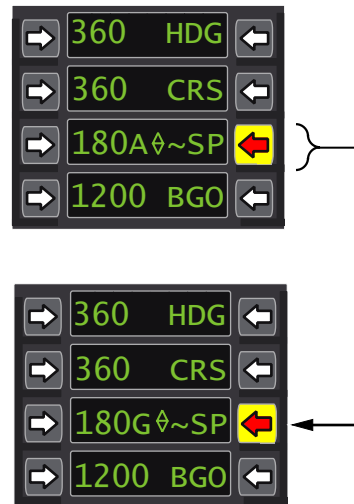

T38002-428-1-020

Figure 1-70. Speed Bug Switches

Setting The BINGO (BGO) Fuel Quantity

Window 4L displays the current BINGO caution fuel quantity setting. Pressing UL-4 enables data entry in three or four digits: thousands, hundreds, and tens of pounds (trailing zero must be included). Valid BGO range is 100 to 4000 in 10 pound increments. The MDP powerup default is 1500. A flashing BINGO caution is activated in the HUD and MFD message windows when the aircraft fuel quantity decreases to below the selected BGO value. When the Inc/Dec symbol is present in window 4, pressing keypad buttons 2/+ or 8/- increments or decrements BINGO setting by 100 pounds.

VIDEO TAPE RECORDER (VTR) FUNCTION KEY

Pressing the VTR Function Key activates the VTR Key Display, Figure 1-71, which is used for control of the following:

Manual Start/Stop Of Recording

When a cassette is inserted into the video tape recorder, pressing UL-2 (HUD), UL-3 (MFD), or UR-2 (CMB) starts recording in the mode selected. If

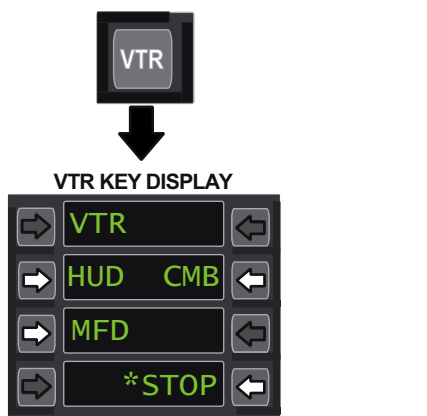

Figure 1-71. Video Tape Recorder (VTR) Function Key

a selection other than the current operating mode (not to include STOP) is selected, the VTR deactivates the previous mode before activating the newly selected mode of operation. Pressing UR-4 (STOP) stops recording. An asterisk * is displayed next to the selected mode.

Selection Of The Recording Source

The VTR recording source is selected as follows:

- a. Pressing UL-2 activates the HUD only recording mode.
- b. Pressing UR-2 activates the CMB recording mode. The CMB (Combination) mode records the

HUD and the front MFD by recording 6 seconds of HUD video followed by 0.6 seconds of FCP MFD video.

- c. Pressing UL-3 in the FCP or RCP activates that cockpit's MFD recording mode. Window 3L's display changes to MFD*F when FCP MFD is the designated recording source or to MFD*B when the RCP MFD is the designated recording source.

NOTE

The Light Emitting Diode (LED) above the VTR Function Key on the UFCP illuminates anytime the VTR is recording.

VTR Key Display

CHECK CASSETTE, Figure 1-72, is displayed in windows 3 and 4, if any of the following conditions occur:

- a. No tape is inserted.
- b. Tape has reached the end of tape.
- c. VTR has internal failure/damage.

OFF/WRITE PROTECTED CASSETTE, Figure 1-73, is displayed in windows 2, 3 and 4, if any of the following conditions occur:

- a. VTR has no power.
- b. There is no connection to the VTR.
- c. A write protected cassette is installed.

d. VTR is defective.

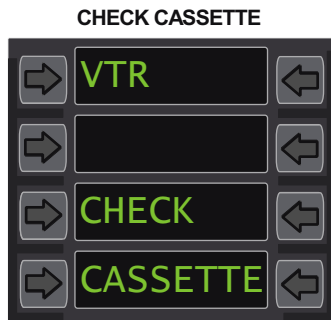

Figure 1-72. VTR Key Display Check Cassette T38002-430-1-020

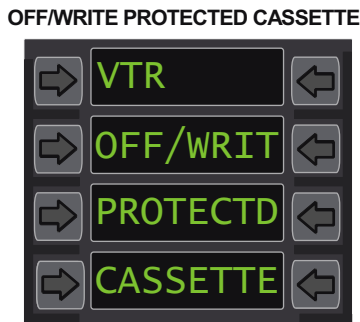

Figure 1-73. VTR Key Display OFF/WRITE Protected Cassette T38002-431-1-020

NOTE

- In some cases, the above indications (Figure 1-72 and 1-73) are not displayed until 5 seconds after selecting a recording mode.
- Cassette failure indications are unpredictable. The VTR Key Display may indicate CHECK CASSETTE, OFF/WRITE PROTECTED CASSETTE, or normal recording.

WITNESS (WIT) FUNCTION KEY

Pressing the WIT Function Key, Figure 1-74, accomplishes the following:

a. The first press starts the chronometer. Subsequent activations reset it to zero and immediately restart the chronometer hack.

b. Anytime the WIT Function Key is pressed, a 1.5 second video mark (black rectangle) is created on the HUD video and a white triangle is created in the upper right hand corner of the MFD video, except when the HUD Repeater Display Page or EED Display Page are displayed on the MFD.



Figure 1-74. Witness (WIT) Function Key T38002-477-1-020

ACKNOWLEDGE (ACK) FUNCTION KEY

Pressing the ACK Function Key, Figure 1-75, removes all HUD/MFD Warning/Caution/Advisory (WCA) displays and silences all warning and caution tones in both cockpits, except for the landing gear warning horn.



Figure 1-75. Acknowledge (ACK) Function Key T38002-478-1-020

NOTE

- Landing gear warning horn is silenced by pressing the SIL button next to the landing gear handle.
- Acknowledging the BINGO caution via the UFCP ACK Function Key requires a lower bingo value be set to reenale the BINGO caution.

The following items are not affected by pressing the ACK Function Key:

- MASTER CAUTION Light
- FIRE Light
- Caution Light Panel
- Landing gear handle warning lights
- Break X in A/G mode, refer to T.O. 1T-38C-34-1-1

T.O. 1T-38C-1
UFCP

HEAD-UP DISPLAY (HUD) FUNCTION KEY

Pressing the HUD Function Key selects the HUD Key Display, Figure 1-76, which is used for definition and selection of the following:

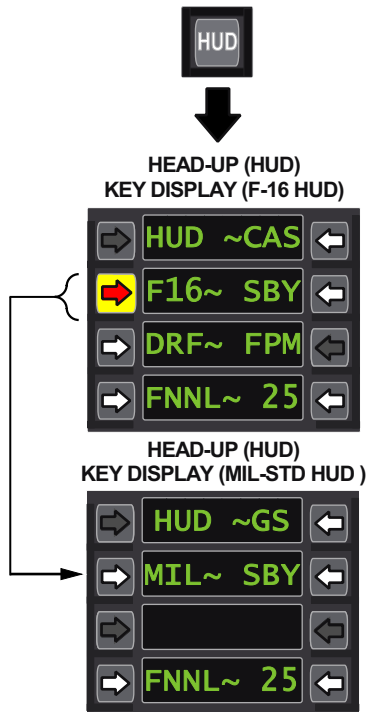

T38002-432-1-020

Figure 1-76. Head-Up Display (HUD) Function Key

Selection Of MIL-STD or F-16 HUD Display Mode.

Window 2L shows the active HUD mode selection. Pressing UL-2 toggles between F-16 (F16) and MIL-STD (MIL) HUD display modes.

Selection Of F-16 HUD Flight Path Marker (FPM) - Drift Cutout (DCO) Or Free Drift (DRF)

For the F-16 HUD, Window 3L shows the current FPM option (DCO/DRF) and pressing UL-3 toggles between DCO and DRF options; MDP powerup default is DRF. For MIL-STD HUD, this function is not operative and Window 3L is blank with UL-3 inoperative.

Selection Of A/A Gun Reticle Type (FNNL/LCOS)

Window 4L displays the current A/A gun reticle type. Pressing UL-4 toggles between FNNL and LCOS.

MDP powerup default is FNNL. Refer to T.O. 1T-38C-34-1-1.

Selection Of MIL-STD HUD Secondary Speed Type

Window 1R displays the secondary speed type. Pressing UR-1 cycles between GS, MACH and TAS. The following defaults apply after MDP powerup:

Master Mode	Default Secondary Speed Type	Selectable Secondary Speed Types
NAV	GS	TAS, MACH
A/A	MACH	None
A/G	TAS	MAC (via UFCP WPN display)

Selection Of F-16 HUD Speed Type

Window 1R displays the current speed type selection. Pressing UR-1 cycles between CAS, TAS, and GS. When the gear is up, the HUD speed display matches the UFCP speed type selection. When the gear is down, the HUD speed display is always CAS regardless of the UFCP speed type selection. The following defaults apply after MDP powerup:

Master Mode	Default Speed Type	Selectable Speed Types
NAV	CAS	TAS, GS
A/A	CAS	None
A/G	CAS	TAS

Selection Of Standby Reticle

Window 2R displays the status of the HUD standby (SBY) reticle. Pressing UR-2 selects either the normal HUD display or standby reticle; SBY is displayed with an asterisk when the standby reticle is selected (*SBY).

Selection Of Gun Reticle Size

The gun reticle size is only operational with FNNL~ selected. The MDP powerup default is 25 ft. Pressing UR-4 allows data entry from 1 to 99 ft (leading zero

required if ENT Key not used). Refer to T.O. 1T-38C-34-1-1.

DECLUTTER (DCL) FUNCTION KEY

A HUD declutter function is provided by the UFCP DCL Function Key, Figure 1-77 (zero key on the numeric keypad). The ability to remove non-essential symbology from the HUD is provided by the declutter (DCL) key. The declutter function applies for both the MIL-STD and F-16 HUDs. The mission planning file loaded via the DTS defines the specific symbology removed when declutter is selected for each master mode, respectively.



T38002-479-1-020

Figure 1-77. Declutter (DCL) Function Key

The DCL default upon MDP powerup is OFF (normal display of all the relevant symbology). Subsequent presses of the DCL key toggles between ON and OFF. Changing master modes automatically turns DCL OFF with a normal display of all the relevant HUD symbology. Transitions between the MIL-STD HUD and the F-16 HUD do not change the status of the DCL selection. Declutter via the 0/DCL key is only possible if there are no UFCP windows in data entry mode. If there are, the key functions as a zero key only.

NOTE

Confusion may result from the RCP aircrew initiating HUD declutter options that affect the FCP pilot's displays without the FCP pilot's knowledge.

Refer to F-16 HUD DECLUTTER and MIL-STD HUD DECLUTTER, this section.

CLOCK (CLK) FUNCTION KEY

Pressing the UFCP CLK Function Key selects the Clock Key Display, Figure 1-78, which is used for definition and selection of the following:

Selection Of The Time Reference (Time Of Day [TOD] Or Chronometer [CRN])

Window 1R displays the selected time reference for TOT computations. Pressing UR-1 toggles between TOD and CRN.



CLOCK (CLK) KEY DISPLAY



T38002-433-1-020

Figure 1-78. Clock (CLK) Function Key

Enable TOD Manual Update

Window 2 displays the TOD as set by the aircrew or via the EGI system (HH:MM:SS). When ~TOD is selected in Window 1R, this time is the reference for TOT computations. Pressing UL-2 initiates the TOD setting. If the system is receiving a GPS time input, the aircrew may enter a TOD value, but the entered time is immediately replaced with the GPS time.

NOTE

- At MDP powerup, if the EGI does not provide GPS time, the TOD displayed is the time elapsed since MDP powerup. Time elapsed since MDP powerup may be replaced by aircrew at anytime when no GPS time data is available. The time is replaced automatically with GPS time data at EGI powerup and establishment of the GPS time data.
- If GPS time data failure occurs and the TOD is already displayed on the UFCP, the TOD continues to be updated by the MDP.

Manual Update Of CRN Time

Window 3 displays the chronometer time (HH:MM:SS); MDP powerup default is 00:00:00. When ~CRN is selected in Window 1R, this time is the reference for all TOT computations generating a system commanded speed caret on the HUD. Pressing UL-3, whether the chronometer is running or not,

T.O. 1T-38C-1

UFCP

replaces the time with dashes in the display and enables the pilot to enter the six digit (HH:MM:SS) start time. Pressing UL-3 a second time before the entry is complete, selects 00:00:00. Pressing UR-3 toggles between starting and stopping the chronometer. If the time setting is not complete, the time does not run.

NOTE

When a new time is entered, the previous time continues to run on the HUD and MFD until the new time is accepted or UR-3 is pressed.

Enable Chronometer Hack (HAC)

Window 4L displays HAC and pressing UL-4 stops the chronometer, returns the lapsed time to 00:00:00, and immediately restarts the chronometer.

NOTE

The MFD hack function (pressing MOSB ML-7 on the PFR or HSD display) and the UFCP hack function work in parallel, activating the same chronometer; therefore, the UFCP and MFD show the same hack time.

For MFD chronometer hack functionality, refer to PFR OSB LABELS AND FUNCTIONS, this section.

Selection Of The Delta Time (ΔT) Sub-Menu Display

Window 4R displays ΔT and pressing UR-4 activates the UFCP ΔT Sub-Menu Display, Figure 1-79. Delta time is required to obtain the local time display. This data can be transferred at any time via the DTS or by the aircrew. After activation, the ΔT Sub-Menu Display is used for definition and selection of the following:

- a. Window 2L displays whether the selected Delta Time is earlier than or later than Greenwich Mean Time (GMT or ZULU). Pressing UL-2 toggles between $-\Delta T$ (earlier than GMT) and $+\Delta T$ (later than GMT). GPS time data is ZULU time.
- b. Window 2R displays the time difference between local time and GMT. Pressing UR-2 initiates entry of the Delta Time in hours. The Inc/Dec function can also be used to change ΔT .

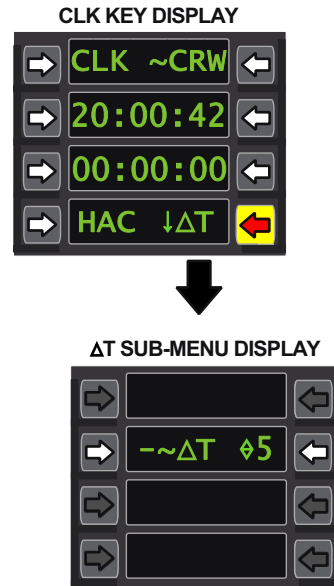

Figure 1-79. UFCP ΔT Sub-Menu Display

T38002-434-1-021

DISPLAY TEST (TST) FUNCTION KEY

Pressing the UFCP TST Function Key enables a visual test of the UFCP LED lights and window display elements. The elements and lights illuminate simultaneously as long as the TST Function Key is pressed; release of this key returns the UFCP to the active display.

BULLSEYE SELECT FUNCTION KEY

Pressing the Bullseye Select Function Key (double circle) selects the Bullseye Key Display, Figure 1-80, which is used for definition and selection of the following:

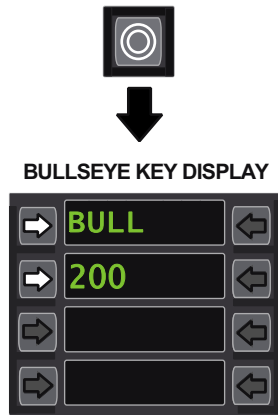

T38002-436-1-020

Figure 1-80. Bullseye Select Function Key

Activation/deactivation of the Bullseye function

Window 1L displays the title BULL. Pressing UL-1 activates/deactivates the Bullseye function. MDP powerup default is off. When activated, an asterisk (*) is displayed after the title.

Selection Of The Bullseye Reference Point

Window 2L displays the selected Bullseye point. MDP powerup default is destination point 200. Pressing UL-2, clears window 2L and allows a 2-7 character entry of a 3 digit destination point or an ICAO point. ICAO point entry consists of a 2-5 alphanumeric ICAO designator plus an optional group letter: N (Navaid), W (Waypoint) or A (Airport). The group letter is entered following the ICAO by typing a space (SP button on alphabetic keypad) then the group letter. The space and group letter are not displayed after data entry is complete (UFCP ENT Key is pushed).

IDENT (IDT) FUNCTION KEY

Pressing the UFCP IDT Function Key, Figure 1-81 activates IFF ident function for 15 seconds (same as pressing UR-4 on the IFF Key Display). See IFF FUNCTION KEY, this section.



T38002-475-1-020

Figure 1-81. Ident (IDT) Function Key

FLIGHT PLAN (FPL) FUNCTION KEY

Pressing the UFCP FPL Function Key activates the FPL Key Display, Figure 1-82 which is used for definition and selection of the following:



FLIGHT PLAN (FPL) KEY DISPLAY



T38002-437-1-020

Figure 1-82. Flight Plan (FPL) Function Key

Selecting A Flight Plan (0 thru 9) For Review Or Update

Window 1R shows the number of the selected FPL. The default selected FPL at MDP powerup is last selected and is initialized to FPL 0 upon DTC data load. Changing the flight plan at UR-1 also changes the active EGI flight plan at window 3R of the NAV Sub-Menu Display.

Modification Of Flight Plan Waypoints

Window 2L displays the 2-digit waypoint number followed by a W (waypoint); the default at FPL Function Key actuation is 01. Window 2R displays the point allocated to the waypoint displayed in window 2L. The point is either a 3-digit destination point preceded by a D (destination) or a 2-5 digit ICAO identifier. Both W and D are not displayed for ICAO points allocated to waypoints.

T.O. 1T-38C-1

UFCP

Pressing UL-2 initiates data entry of a waypoint number (01 thru 15) in Window 2L. The Inc/Dec function, while not in data entry mode, increments or decrements the waypoint number by 1.

Pressing UR-2 initiates data entry of a destination number (numeric keypad) or ICAO identifier (alphabetic keypad) for the waypoint selected at UL-2. The first waypoint (D200) and last waypoint (999) can not be edited. Valid destination entries for Window 2R are all destination and ICAO points. Group letters may be entered with ICAO points (N - Navaid, W - Waypoint, A - Airport) preceded by a space.

Definition of the time schedule for the navigation route.

Window 3 displays the TOT assigned to the current waypoint using 6-digits in a 24-hour format (HH:MM:SS). Pressing UL-3 initiates entry of a new TOT via the numeric keypad. The number 99:99:99 is used to cancel a previously assigned TOT and is the default at MDP powerup.

NOTE

The TOT must be activated (*) in the TOT Sub-Menu Display in order for the flight plan TOT function to operate.

ADD/DELETE Flight Plan Waypoints

Window 4L displays ADD; Window 4R displays DEL (delete).

Pressing UL-4 (ADD) clears the information in Window 2R and replaces it with dashes, enabling entry of a new point (DEST or ICAO). The previous waypoint and all subsequent waypoints including the dummy waypoint 999 are shifted to the next sequential waypoint. The last waypoint, which was assigned to waypoint 15, is removed from the FPL.

Pressing UR-4 (DEL) replaces the current waypoint data with the subsequent waypoint data. All of the subsequent waypoints are shifted backwards in the FPL; the FPL is shortened by one waypoint. The data assigned to the final waypoint is automatically designated 999 and defines the end of the FPL.

Selecting The FPL Sub-Menu Display

Pressing UL-1 (FPL↓) activates the UFCP FPL Sub-Menu Display. Refer to FPL Sub-Menu Display, this section.

FPL SUB-MENU DISPLAY

The UFCP FPL Sub-Menu Display, Figure 1-83, is used to view waypoint IDs and change waypoint steering type as follows:

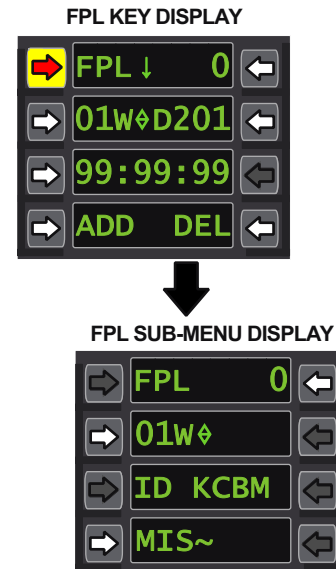

Figure 1-83. FPL Sub-Menu Display

T38002-438-1-020

Flight Plan Selection

Pressing UR-1 enables data entry of a flight plan number (0-9). Changing the flight plan in this display changes the active EGI flight plan and defaults to waypoint 01 in window 2. Windows 3 and 4 update to reflect data for waypoint 01 of new flight plan.

Selection of a waypoint number

Pressing UL-2 enables data entry of a waypoint number (01 - 15). The Inc/Dec function, while not in data entry mode, increments or decrements the waypoint number by 1. Changing the waypoint number in this display changes the waypoint displayed on the FPL Function Key Display. Windows 3 and 4 update to reflect data for new waypoint.

Selection of a new steering type

Pressing UL-4 cycles through the following possible steering types:

- FBY (Flyby)
- OVR (Flyover)
- IAF (Initial Approach Fix)

- d. FAF (Final Approach Fix)
- e. APT (Airport)
- f. MIS (Missed Approach Point)

Refer to DESTINATION DATABASE MANAGEMENT, this section.

DESTINATION (DST) FUNCTION KEY

The UFCP DST Function Key selects the DST Key Display, Figure 1-84, which is used for definition and selection of the following:

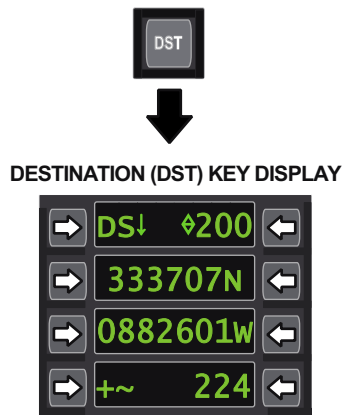

T38002-439-1-020

Figure 1-84. Destination (DST) Function Key

Viewing The Destination Number And Lat/Long Or UTM Coordinates

The default selection displayed in window 1R upon pressing the UFCP DST Function Key is the steerpoint, displayed as follows:

- a. If the steerpoint is a Destination point Window 1R displays 3-digit destination point value.
- b. If the steerpoint is a Waypoint window 1R displays the 3-digit destination point counterpart (waypoint # cannot be viewed on this display).
- c. If the steerpoint is an ICAO point window 1R displays destination point 200 or the last destination point selected before selecting an ICAO point as the steerpoint (ICAO identifiers cannot be viewed on this display).

The default coordinate system displayed in windows 2 and 3 upon pressing the UFCP DST Function Key is the World Geodetic Survey (WGS- Lat/Long) coordinate system. The Universal Transverse Mercator

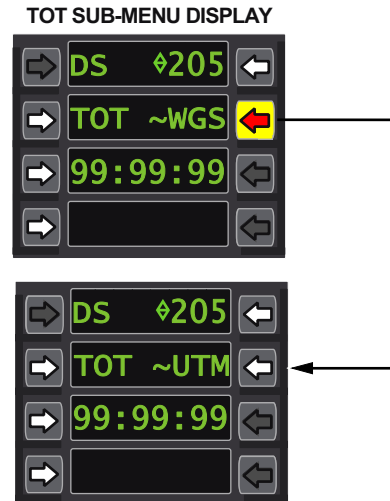

T38002-440-1-020

Figure 1-85. TOT Sub-Menu Display

(UTM) coordinate system may also be viewed by toggling coordinate systems via UR-2 of the TOT Sub-Menu, Figure 1-85.

Selecting the TOT Sub-Menu Display

Pressing UL-1 (DS↓) activates the UFCP TOT Sub-Menu Display. Refer to TOT Sub-Menu Display, this section.

Selecting a New Destination Number

Window 1R shows the currently selected 3-digit destination number. Pressing UR-1 enables entry of a new destination number, 200 thru 509 and 600 thru 610. Selecting a new destination number is done the same way with either WGS or UTM coordinate system selected.

T.O. 1T-38C-1

UFCP

Programming Destination Lat/Long Coordinates

The DST Key Display must be displayed in WGS coordinate system format to program destination lat/long coordinates. If the destination point cannot be programmed, UL/UR-2, UL/UR-3, and UL/UR-4 are inoperative. Window 2 displays the latitude and Window 3 displays the longitude of the selected destination point (displayed in window 1R). Lat/Long coordinate entry allows for navigation precision to degrees, minutes and thousandths of minutes. If a destination point does not have data associated with it, all numerical fields in windows 2 and 3 appear blank. The letter N (North) is displayed in window 2R and the letter W (West) is displayed in window 3R. Window 4 displays a zero elevation as +- 0.

When in the data entry mode on the UFCP DST Key Display, the UFCP window digit displays are used to show latitude and longitude; the N or S (latitude) and W or E (longitude) designations are removed during data entry display mode. After entry, the last digit remains displayed for 3 seconds and then the display switches to the appropriate N/S for latitude and W/E for longitude. Refer to DESTINATION DATABASE MANAGEMENT, this section.

Lat/long coordinate entry is accomplished as follows:

a. Window 2 displays latitude for the selected destination point displayed in Window 1R. Pressing UL-2 enables entry of new latitude data. Pressing UR-2 toggles between N and S.

b. Window 3 displays longitude for the selected destination point displayed in Window 1R. Pressing UL-3 enables entry of new longitude data. Pressing UR-3 toggles between W and E.

Programming Destination UTM Coordinates

The UFCP DST Function Display must be displayed in the UTM coordinate system format to program destination coordinates. If the destination point can not be programmed, UL/UR-2, UL/UR-3, and UL/UR-4 are inoperative. Window 2 displays the grid zone and 100 km squared block of the point selected in window 1. Window 3 displays the x and y coordinates. The first four digits represent meters in the eastern direction and the last four digits represent meters in the northern direction. If a destination point does not have data associated with it, all numerical fields in windows 2 and 3 appear blank. Window 4 displays a zero elevation as +~ 0000.

UTM coordinate entry is accomplished as follows:

a. Pressing UL-2 enables entry of a new zone or semicircle/hemisphere. Pressing UR-2 enables entry of a new 100 km squared block.

b. The aircrew is not required to enter all four digits for each of the East and North coordinates. Aircrew must enter an even number of digits via UL-3; the entry is split in half, and the first half of the entry is defined as the East coordinate, and the second half is the North coordinate. Zeros are added after the first and second half to complete 4 digits each for East and North, 8 digits total. For example, if aircrew enter 123456, then East = 1230 meters and North = 4560 meters offset from the bottom left corner of the grid zone. UR-3 is inactive.

Designating Elevation Of A Destination Number

Window 4 displays the elevation of the destination point selected in window 1R. Window 4L displays a + or - to designate above or below mean sea level; pressing UL-4 toggles between +~ and -~. Window 4R displays the 4-digit elevation in feet; pressing UR-4 enables data entry of new altitude data in feet, according to the following:

ALTITUDE	VALIDITY
-9999 to -4001	Invalid entry -window flashes
-4000	Valid entry, signifies undefined altitude window blanks
-3999 to +9999	Valid entry - displayed steady

Designating elevation of a destination number is done the same way with either WGS or UTM coordinate system selected.

TOT SUB-MENU DISPLAY

The UFCP TOT Sub-Menu Display, Figure 1-86, is used for the following:

a. Activation of the TOT Commanded Speed Indicator: Pressing UL-2 toggles between activation/deactivation. This selection controls TOT when the steerpoint is a destination point or while flying a flight plan. An asterisk is displayed when activated (TOT*).

coordinate system selected on the UFCP TOT Sub-Menu Display.

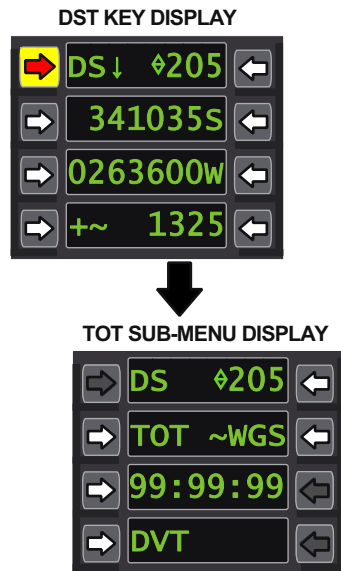

Figure 1-86. TOT Sub-Menu Display T38002-441-1-020

NOTE

- The TOT is related to the type of clock selected, TOD or CRN. Refer to CLOCK (CLK) FUNCTION KEY, this section.
- The TOT Commanded Speed Indicator must be selected to enable the functionality of TOT Commanded Speed Indicator when either a 3-digit destination or a flight plan is selected as EGI source.

b. Designating TOT value: Pressing UL-3 enables data entry (HH:MM:SS) for new TOT values.

c. Emergency Divert Mode (DVT) activation: Pressing UL-4 toggles between activation/deactivation. An asterisk is displayed when activated (DVT*).

NOTE

DVT flashes and is not selectable if an engine type has not been selected on the MFD Data Display Page.

d. Changing coordinate systems: Pressing UR-2 toggles between ~WGS and ~UTM. Windows 2 and 3 of the UFCP DST Key Display will reflect

COMMUNICATION (COM) FUNCTION KEY

The UFCP COM Function Key selects the COM Key Display, Figure 1-87, which is used for definition and selection of the following:

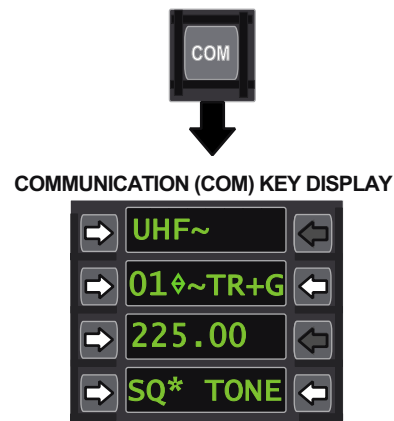

Figure 1-87. Communication (COM) Function Key T38002-442-1-020

Selection Of UFCP UHF Or VHF COM Key Displays

The default upon selection of the COM Function Key is the UHF COM Key Display. Pressing UL-1 toggles between UHF~ and VHF~ COM Key Displays, Figure 1-88.

Viewing of UFCP preset channels and associated frequencies (UHF/VHF)

The respective UHF and VHF channels default to the currently displayed preset or last selected preset if a manual frequency is shown on the UFCP Basic Menu Display. Selection of a new channel on the COM Key Display for either radio does not affect the current radio selection set via the UFCP Basic Menu. Window 2L displays the selected preset channel (01 thru 40) or GRD [243.0 (UHF)/121.5 (VHF)] when Guard is selected Pressing UL-2 enables selection of a new preset channel; leading zeros are required for preset channel 01 thru 09. Pressing keypad buttons 2/+ or 8/- increments or decrements to the next preset. The



T38002-443-1-020

Figure 1-88. UFCP UHF or VHF COM Key Displays

associated frequency is changed accordingly in window 3L upon completion of preset channel data entry. Window 3L displays the frequency of the preset channel shown in window 2L or the Guard frequency if G is selected in window 2R. OFF is displayed if the associated radio is OFF or inoperative.

Programming of UFCP Preset Channel Frequencies

Channel assignments can be manually set via the UFCP COM Key Display or loaded via the DTS. Pressing UL-3 enables entry of a new frequency for the channel displayed in Window 2L. This frequency change affects only the normal operation via the UFCP and does not affect the setting when the system is controlled via the UHF Backup Control Panel.

NOTE

- If the AAP Backup Mode Control Knob is in UHF B/U, the UHF COM Key Display shows UHF~ in Window 1L, OFF in Window 2, and Windows 3 and 4 are blank. Pressing UL-1 selects the VHF COM Key Display and VHF operation is normal.

- If the AAP Backup Mode Control Knob has NORM selected and the UHF/VHF frequency has failed to tune (i.e. system malfunction), the commanded frequency will flash for 3 seconds and then the reported (tuned) frequency will be displayed steady.

Selection Of Radio Mode Of Operation (UHF/VHF)

Window 2R displays the mode of operation. Modes of operation are as follows:

MODE	OPERATION
TR	The UHF or VHF transmits and receives on the selected preset channel or manual frequency.
TR+G	The UHF transmits and receives on the selected preset channel or manual frequency, also receives on Guard.
G	The UHF or VHF transmits and receives on Guard only.

Pressing the UR-2 toggle button selects the mode of operation for UHF when on the UHF COM Key Display and for VHF when on the VHF COM Key Display as follows:

- VHF - [TR → G → TR...]
- UHF - [TR+G → G → TR → G → TR+G...]

Any changes in radio mode (TR, TR+G, G) are active upon selection of that mode.

NOTE

The G Hot Key temporarily disables the UHF guard channel for 1 minute. Refer to HOT KEYS, this section.

Selection of Squelch Mode (UHF/VHF)

Window 4L displays the selected squelch (SQ) status. Pressing UL-4 toggles between SQ* (squelch ON) and SQ (squelch OFF) if the radio is operational. MDP powerup default is SQ*. The V Hot Key toggles the VHF squelch ON/OFF and the U Hot Key toggles the UHF squelch ON/OFF. Refer to HOT KEYS, this section.

Activation Of UHF Test Tone (UHF page only)

Pressing UR-4 on the UHF COM Key Display activates the 1-KHz UHF test tone for 1.5 seconds if the radio is operational.

Activation Of CHAF (VHF page only)

Pressing UR-4 on the VHF COM Key Display toggles between CHAF (deactivated) and CHAF* (activated). MDP powerup default is CHAF (deactivated). Refer to T.O. 1T-38C-34-1-1.

IDENTIFICATION FRIEND OR FOE (IFF) FUNCTION KEY

The UFCP IFF Function Key selects the IFF/TCAS (IFF) Key Display, Figure 1-89, and provides display and control of the following IFF and TCAS functions and parameters:

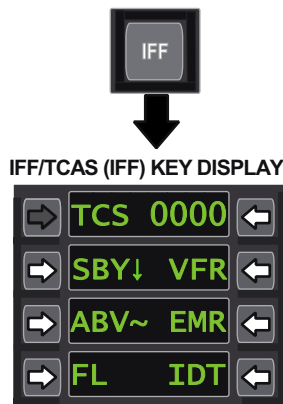

Figure 1-89. Identification Friend Or Foe (IFF) Function Key
T38002-444-1-020

Selection Of IFF Squawk

Window 1R displays the current 4-digit (0 thru 7) transponder mode 3 ATC code. Pressing UR-1 enables entry of a new code number via the numeric keypad. The MDP default ATC code at powerup is the last manually entered.

Selection Of IFF/TCAS mode

Window 2L displays the current IFF and TCAS mode of operation: SBY↓, A↓, C↓, TA↓, or RA↓. Pressing UL-2 activates the TCAS (TCS) Sub-Menu Display,

Figure 1-90; pressing the adjacent OSB of the desired IFF and TCAS mode selects that mode, places an asterisk after the display, and automatically returns to the IFF Key Display. MDP powerup default is SBY↓. The IFF and TCAS operation modes are selected as follows:

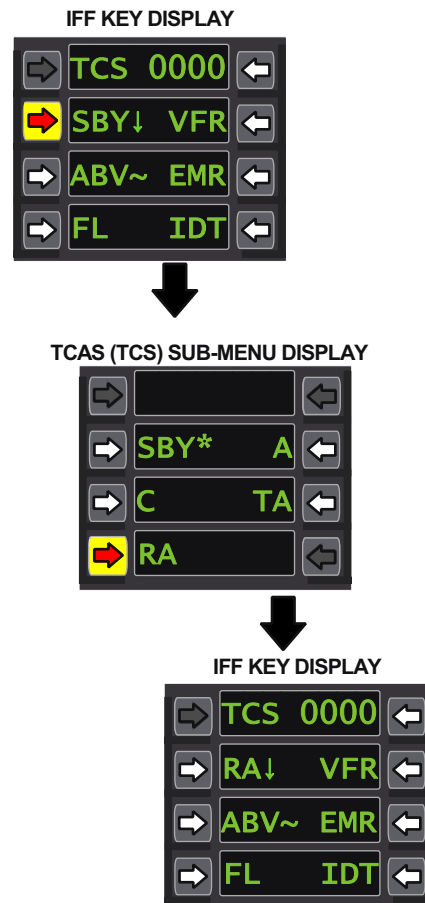

Figure 1-90. TCAS (TCS) Sub-Menu Display
T38002-445-1-021

- a. SBY (standby) Mode - pressing UL-2.
- b. Mode A - pressing UR-2 selects mode A.
- c. Mode C (C+A) - pressing UL-3 selects mode C.
- d. Mode TA (C+A+TA) - pressing UR-3 selects the Traffic Advisory (TA) mode.
- e. Mode RA (C+A+TA+RA) - pressing UL-4 selects the Resolution Advisory (RA) mode.

T.O. 1T-38C-1 UFCP

Refer to IDENTIFICATION FRIEND OR FOE (IFF)/TRAFFIC COLLISION AVOIDANCE SYSTEM (TCAS), this section.

NOTE

Short power interruptions (50-300 msec), such as generator shifts/cycles, cause the MDP to command the TCAS to SBY. Therefore, after any AC power interruption to the TCAS, TCAS operation mode should be checked and reset, as required.

Selection Of VFR Code

Window 2R displays VFR; an asterisk is displayed when the function is operative. Pressing UR-2 selects the VFR code (1200 or as programmed via mission planning); the VFR code is displayed in window 1R. The function can be deselected by pressing UR-2 again; the last ATC code value is restored. The window displays OFF when the TCAS system is OFF.

Section Of Relative TCAS Altitude Display Limits

Window 3L displays the currently selected TA/RA relative altitude display limits: ABV↓, BLW↓, NOR↓, or BLK↓. Pressing UL-3 cycles through four options with a TCAS powerup default selection of ABV↓. Refer to IDENTIFICATION FRIEND OR FOE (IFF)/TRAFFIC COLLISION AVOIDANCE SYSTEM (TCAS), this section.

Selection Of EMERGENCY Code

Window 3R displays EMR. Pressing UR-3 selects the EMR code (7700 or as programmed via mission planning) and displays an asterisk next to EMR; the EMR code is displayed in window 1R. The function can be deselected by pressing UR-3 again; the last ATC code value is restored.

Selection Of TCAS Flight Level (FL) Display Mode

Window 4L displays the TCAS display flight level (FL) option. Pressing UL-4 activates flight level display mode and displays an asterisk after the display FL* when the function is operative. The intruder and ownship altitude are displayed on the MFD in FL format when the flight level function is activated. The MFD display returns to the relative altitude display format when FL display mode is deactivated.

Selection Of Ident

Window 4R displays IDT; pressing UR-4 activates Ident for 15 seconds. An asterisk is displayed (*IDT) for the duration of the Ident.

MARK (MRK) FUNCTION KEY

The Mark process is initialized by pressing the UFCP MRK Function Key; this selects the Mark (MRK) Key Display, Figure 1-91; none of the OSBs on the MRK Key Display are functional. The moment the MRK Function Key is pressed, the EGI -computed aircraft present position (PP) coordinates are temporarily stored in memory with the temporary data displayed on the MRK Key Display in the following manner:

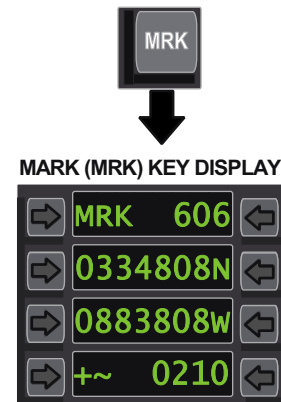

T38002-446-1-020

Figure 1-91. Mark (MRK) Function Key

- Window 1R shows the DEST point where the temporary coordinates will be stored, if accepted.
- Window 2 shows the MARK temporary point latitude in degrees, minutes, and hundredths of minutes (DDMMXX) N (North) or S (South), if accepted.
- Window 3 shows the MRK temporary point longitude in degrees, minutes, and hundredths of minutes (DDDMMXX) E (East) or W (West), if accepted.
- Window 4 shows the temporary MSL elevation of the MRK point or steerpoint, if accepted.

The elevation above Mean Sea Level (MSL) of the MARK point is determined according to the following logic:

- If the RALT altitude is available, the elevation of the MARK point is computed by subtracting the RALT altitude from the aircraft barometric altitude.

b. If the RALT altitude is not available, the elevation stored for the MARK point is that of the steer-point.

MARK execution is accepted by pressing the MRK Function Key a second time within 20 seconds, resulting in the following:

- a. The MRK Key Display is replaced by the UFCP Basic Menu Display.
- b. The aircraft PP coordinates are permanently stored as one of the MARK points (DEST points 605 thru 610).
- c. The first MARK is stored as DEST 605, and additional MARK points are stored in the following DEST points, up thru DEST 610.

NOTE

If more than six MARK points are made, the seventh MARK point is stored starting with DEST 605, overwriting the data from the first MARK point.

A MARK execution abort is accomplished by either of the following:

- a. Manual Abort: The MARK process can be manually aborted by pressing the RTN Function Key within 20 seconds after MRK Function Key press, it is then aborted and the UFCP Basic Menu Display is selected and displayed.
- b. Automatic Abort: The MARK process is automatically aborted if the MRK Function Key is not pressed a second time during the 20 second time interval.

APPROACH (APP) FUNCTION KEY

The UFCP APP Function Key selects the Approach (APP) Key Display, Figure 1-92, which allows the pilot to review a preprogrammed approach. These approaches can be either a NAVAID based (VOR/ILS) or self-contained approaches (SCA). The primary APP Key Display is the same for both NAVAID and SCA approaches, showing coordinates and altitude for the destination in which the approach is based. This data is presented in the following manner:

- a. Window 1L displays the title APP↓ with the destination number (DEST 500 thru DEST 509) in which the approach is based in Window 1R. Pressing UL-1 selects the programmed Approach Sub-Menu Display (NAVAID/SCA); pressing UR-1 enables data

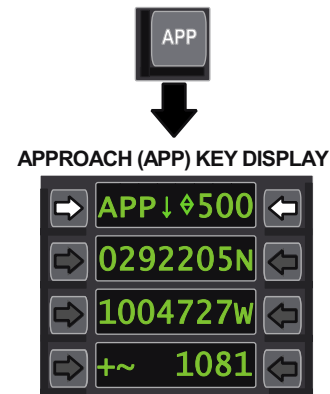

T38002-447-1-020

Figure 1-92. Approach (APP) Function Key

entry for a new PPA DEST number; the default is the approach number in window 2R of the UFCP NAV Sub-Menu Display. Changing the destination number on this page does not affect the current approach number in window 2R of the UFCP NAV Sub-Menu Display.

- b. Window 2 displays the latitude (DDMMXX) with designated N or S for the programmed destination point. UL-2 and UR-2 are inoperative.
- c. Window 3 displays the longitude (DDDMMXX) with designated W or E for the programmed destination point. UL-3 and UR-3 are inoperative.
- d. Window 4L displays the + (above) or - (below) MSL with Window 4R showing the programmed destination point elevation in feet. UL-4 and UR-4 are inoperative.

NOTE

The information on this display is for display only. Changes must be accomplished using the mission planning system.

The UFCP Approach Sub-Menu Display displays the specifics for the approach (NAVAID/SCA).

Approach Sub-Menu Display (for NAVAID) Figure 1-93. All OSBs are inoperative and the data is displayed as follows:

- a. Window 1L shows the programmed NAVAID frequency and Window 1R identifies the selected NAVAID (I for ILS or V for VOR).
- b. Window 2 is blank.

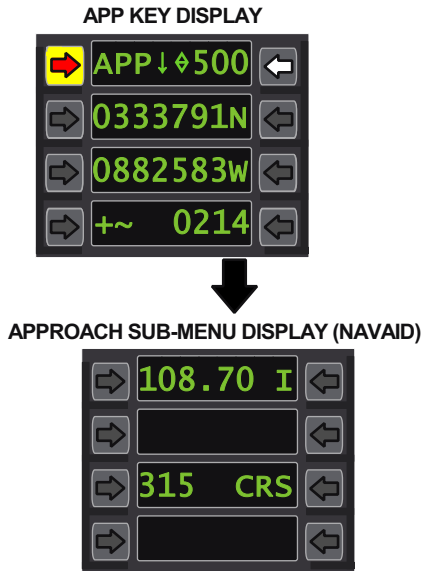

T38002-448-1-020

Figure 1-93. UFCP Approach Sub-Menu Display

- c. Window 3L shows the selected approach course with the course title, CRS displayed in Window 3R.
- d. Window 4 is blank.

Approach Sub-Menu Display (for SCA), Figure 1-94, displays the data as follows:

- a. Window 1L shows the selected glide slope data with the glide slope title, GS displayed in Window 1R. UL-1 and UR-1 are inoperative.

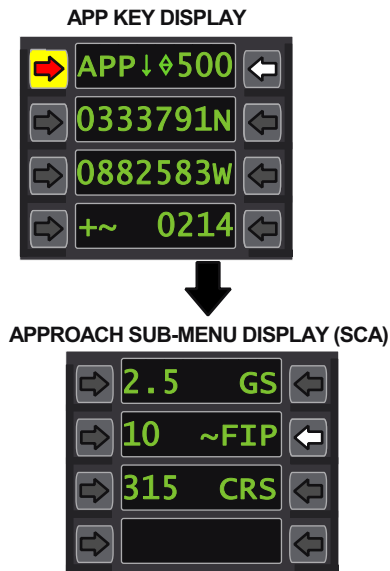

T38002-449-1-020

Figure 1-94. UFCP APPROACH Sub-Menu Display

b. Window 2L indicates range to either the FIP or FAF as selected in Window 2R; pressing UR-2 toggles between FIP and FAF. Approach Sub-Menu Display entry default selection is FIP. UL-2 is not functional.

c. Window 3L shows the programmed approach course and Window 3R displays the course title, CRS. UL-3 and UR-3 are inoperative.

d. Window 4 is blank.

NOTE

The information on this display is for display only. Changes must be accomplished using the mission planning system.

This UFCP APP Key Display and UFCP Approach Sub-Menu Display data reflects what is displayed when the APP Function is executed (APP*) on the NAV Sub-Menu Display Page, Figure 1-54 (Sheet 1), by pressing UL-2 to activate the PPA approach selected in Window 2R. The selected approach can only be deactivated by entering a PPA DEST point different than the one currently entered in window 2R by pressing UR-2 and entering the 3-digit PPA (500 thru 509). If an undefined/no data DEST point is entered from the following displays (i.e. DEST points 506 thru 509 are undefined if the DTC only transfers 500-505), the following occurs:

- a. Basic Menu Display, the undefined entry will flash in window 1R.
- b. NAV Sub-Menu Display, the undefined entry will render UL-2 non-functional and the APP cannot be activated (no asterisk displayed in Window 2L).

EMBEDDED GPS/INS (EGI) FUNCTION KEY

Pressing the UFCP EGI Function Key selects the EGI Key Display, Figure 1-95, which provides display and control of the following EGI functions and parameters:

Control of the Radar RLT Altimeter.

Window 1R displays the status of the RLT; pressing UR-1 turns the RLT ON/OFF and is indicated ON by an asterisk (*RLT). MDP powerup default is ON

Selection of the EGI solution.

The following options select the EGI solution source reference:

Selection of GPS parameters.

Window 4L displays the current GPS code (Y, C, or MIX). When the Y code is available, pressing UL-4 toggles between Y and MIX GPS codes. MIX is the MDP powerup default. When Y code is not available, the C code is displayed and UL-4 is not functional.

WEAPONS (WPN) FUNCTION KEY

Pressing the UFCP WPN Function Key selects the WPN Key Display, Figure 1-96, which allows control of A/G weapons delivery parameters. Refer to T.O. 1T-38C-34-1-1.

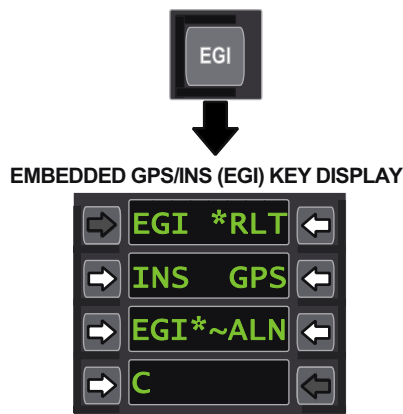

Figure 1-95. Embedded GPS/INS (EGI) Function Key
T38002-450-1-020

- a. Window 2L displays the INS only navigation solution and pressing UL-2 selects INS only as the primary source and is indicated by an asterisk (INS*). UL-1 is not functional.
- b. Window 2R displays the GPS only navigation solution and pressing UR-2 selects GPS only as the primary source and is indicated by an asterisk (*GPS).
- c. Window 3L displays the EGI (blended) navigation solution and pressing UL-3 selects the blended solution as the primary source and is indicated by an asterisk (EGI*). EGI is the MDP powerup default.

Selection of EGI alignment options.

Window 3R displays the ALN, ATT, or NAV option for EGI alignment. The ~ symbol is displayed adjacent to ALN or NAV only on the ground when both the ALN and NAV functions are available. Window 3R is blanked with weight-off-wheels. Pressing UR-3 selects the alignment start/continue option or the navigation mode.

NOTE

Approximately 2 seconds are required for the display to change from ALN to NAV (or vice versa) when commanded via UR-3. If UR-3 is pressed after commanding NAV, the EGI goes back into GC-Align and resumes alignment from the accuracy obtained when NAV was commanded.



Figure 1-96. Weapons (WPN) Function Key
T38002-451-1-021

T.O. 1T-38C-1

UFCP

HOT KEYS

Hot keys provide a one-button-press option to perform various functions on the UFCP and MFD. Several keys on the UFCP alphabetic keypad act as hot keys. Hot key functionality is not available during data entry.

WARNING

Inadvertent pressing of the Q Hot Key can only be detected by referencing the altimeter display on the MFD or selecting the UFCP ALT Key Display.

T38 UFCP HOT KEYS		
UFCP Key(s)	Function Restrictions	Function
A, B, C, D, E, F	A/G MM Only	Selection of weapons programs A thru F
G	None	Temporarily disables UHF Guard for 1 minute
N	None	Displays Nearest Airports page on MFD
Q	None	Toggle between standard QNH (29.92) and manually set QNH
R	None	MFD Repeater Mode Control
V	None	Toggles VHF squelch ON/OFF
U	None	Toggles UHF squelch ON/OFF

NOTE

When the Nearest Airports page is selected via the N Hot key or the MFD Menu Display Page, the MFD display will be empty of airport data unless the DTC is loaded with JMPS files.

HEAD-UP DISPLAY (HUD)

HUD SYSTEM OVERVIEW

The aircraft has a single AC-powered HUD installed in the FCP that is designed as a primary flight reference for normal operations. A collimated display of symbolic flight and weapons delivery information is generated by the MDP and projected onto the HUD enabling the pilot to maneuver the aircraft while maintaining positional awareness during visual or instrument flight. The HUD is inoperative if the MDP fails or is OFF. Refer to T.O. IT38C-34-1-1 for all weapons display/function related descriptions.

The HUD provides a 24° Total Field Of View (TFOV). The Instantaneous Field Of View (IFOV) varies based on distance from the HUD and sitting height, approximately 15°-17°. Except for Time-Of-Day (TOD), chronometer data, and Bullseye bearing/range, HUD symbols are displayed inside the IFOV.

The HUD can be displayed on either MFD by selecting the HUD option from the respective MFD PFR, HSD or Menu Display Page. The HUD can also be displayed on the RCP MFD by pressing the RCP DDS for greater than 1 second.

There are two types of HUD formats: F-16 emulation (F-16 HUD) and MIL-STD HUD. Selection between the two display formats can be done in any master mode or submode via the HUD Key Display, selectable by pressing the HUD Function Key on the UFCP. MDP powerup default is F-16 HUD.

The HUD has several modes that are changed automatically according to the selected avionics master mode (A/A, A/G, or NAV), and A/G submodes. Refer to T.O. 1T-38C-34-1-1 for description of the A/A and A/G functions.

Warning/Caution/Advisory (WCA) displays are presented in the HUD Message Window. WCA priorities are defined for each visual display/aural tone. Refer to WARNING/CAUTION/ADVISORY (WCA) SYSTEM, this section.

The HUD accommodates the Color TV Sensor System (CTVS), which records the outside view together with the HUD symbology. The MDP, HUD, and HUD power supply unit may not operate through all generator crossovers. MDP and HUD response is dependent on the generator crossover connection times. Generator crossover connection times are inconsistent and unpredictable.

Following generator crossovers, the HUD may blink momentarily, return in full DIM, return in full bright, or fail to return completely. If HUD intensity is affected (DIM/BRIGHT/no return) and/or UFCP HUD brightness control does not respond, follow guidance in Section II (ground operations) or Section III (in flight).

HUD CONTROLS AND DISPLAYS

The HUD is controlled via UFCP Switches and Keys. See Figure 1-53, UP FRONT CONTROL PANEL (UFCP), this section.

HUD format displays (F16 versus MIL-STD) are unique. Refer to F-16 HUD and MIL-STD HUD, this section.

T.O. 1T-38C-1

HUD

HUD CONTROLS

HUD and HUD CTVS CAMERA POWER SWITCH

The HUD and HUD CTVS camera are turned ON/OFF via the FCP UFCP Power Switch only (RCP UFCP Power Switch is non-functional). Refer to UFCP CONTROLS AND DISPLAYS, this section and Figure 1-97.



T38002-504-1-001

Figure 1-97. HUD and HUD CTVS Camera Power Switch

HUD BRIGHTNESS (H BRT) ROCKER SWITCH

HUD display brightness is controlled via the FCP UFCP H BRT Rocker Switch (RCP UFCP H BRT Rocker Switch is non-functional). Pressing and holding either side of the H BRT Key in the FCP provides an adjustment of HUD symbology brightness. Pressing the right side (+) increases the brightness, while pressing the left side (-) decreases the brightness. Refer to UFCP CONTROLS AND DISPLAYS, this section and Figure 1-98.



T38002-412-3-020

Figure 1-98. HUD H BRT Rocker Switch

NT/AUT/DAY SWITCH

The HUD display default brightness level is controlled by the FCP UFCP NT/AUT/DAY Toggle Switch (RCP UFCP NT/AUT/DAY Toggle Switch is non-functional). When placed in the automatic (AUT) position, a constant ratio between the brightness of the display and the outside world is maintained by a UFCP feature called Automatic Brightness Control (ABC). When the brightness of the outside surroundings increases, the brightness of the display is increased accordingly, and vice versa. The initial ratio between the brightness of the display and

the outside world is determined by the setting of the FCP UFCP H BRT Rocker Switch. Refer to UFCP CONTROLS AND DISPLAYS, this section and Figure 1-99.



T38002-412-1-020

Figure 1-99. NT/AUT/DAY Toggle Switch

The day (DAY) setting selects a brightness range suitable for daylight lighting conditions. The actual HUD brightness within this range is determined by the setting of the FCP UFCP H BRT Rocker Switch.

The night (NT) setting selects a brightness range suitable for nighttime lighting conditions. The actual HUD brightness within this range is determined by the setting of the FCP UFCP H BRT Rocker Switch.

HUD FUNCTION KEY

The UFCP HUD Function Key is used for selection of HUD parameters. Refer to UFCP FUNCTION KEYS, this section.

F-16 HUD BASIC SYMBOLS

The F-16 HUD basic symbols are shown in Figures 1-100, 1-101 and FO-5.

AIR-TO-AIR TACAN RANGE

When the TACAN receiver is in A/A mode, the A/A TACAN range is displayed in the lower right corner of the HUD. The display reads AAT followed by the A/A TACAN range. The range is displayed above the EGI/NAV Data Block, Figure 1-102.



Under dynamic conditions (i.e., high rates of closure or separation), displayed AAT ranges may differ greatly from actual slant ranges between aircraft.

NOTE

- If there is no range reception, the prefix AAT is displayed, but the range is blank.
- When AAT is selected, TACAN bearing and all DME information are removed.

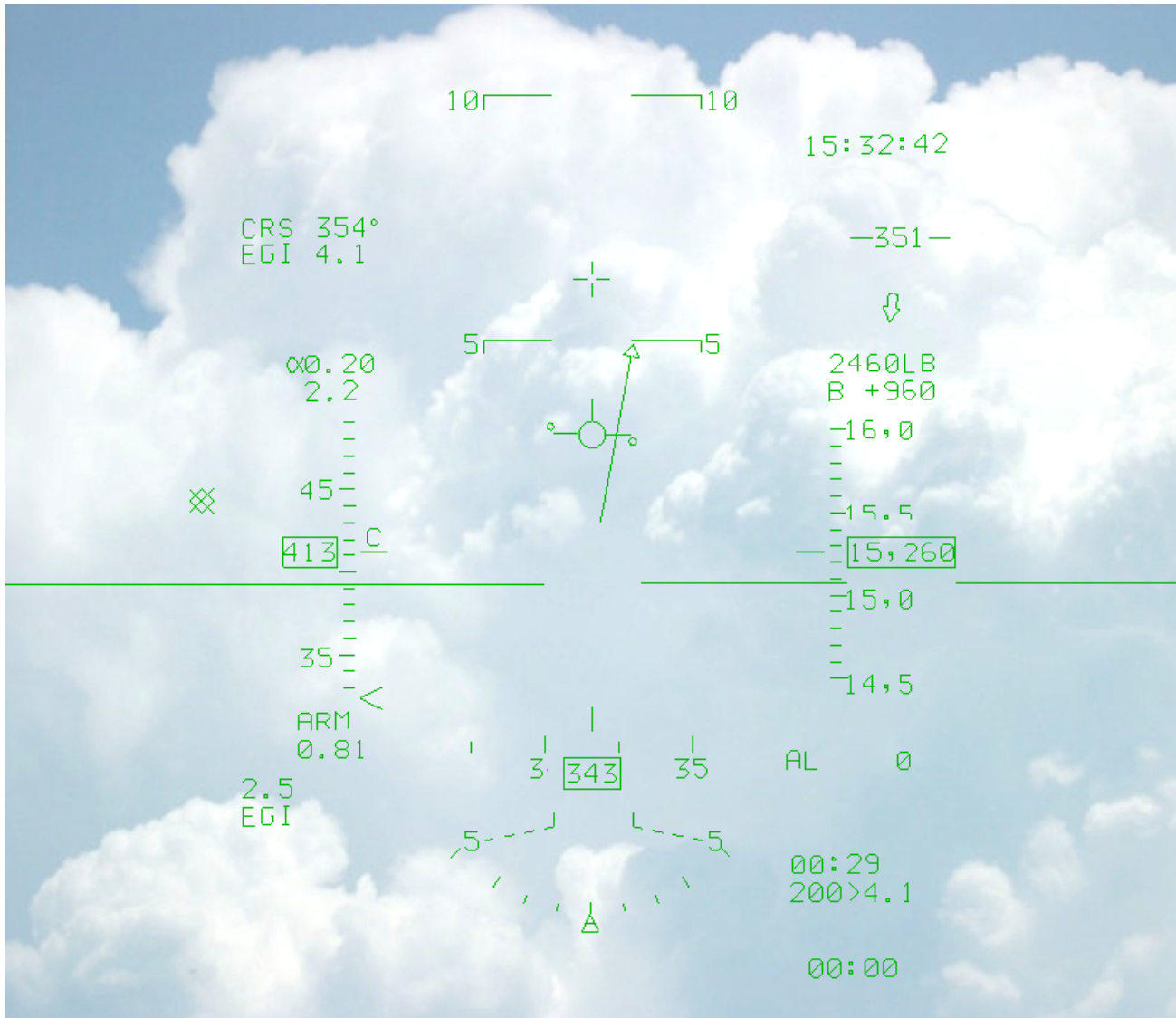

Figure 1-100. F-16 HUD

T38002-495-1-001

**T.O. 1T-38C-1
HUD**

BASIC SYMBOLOGY

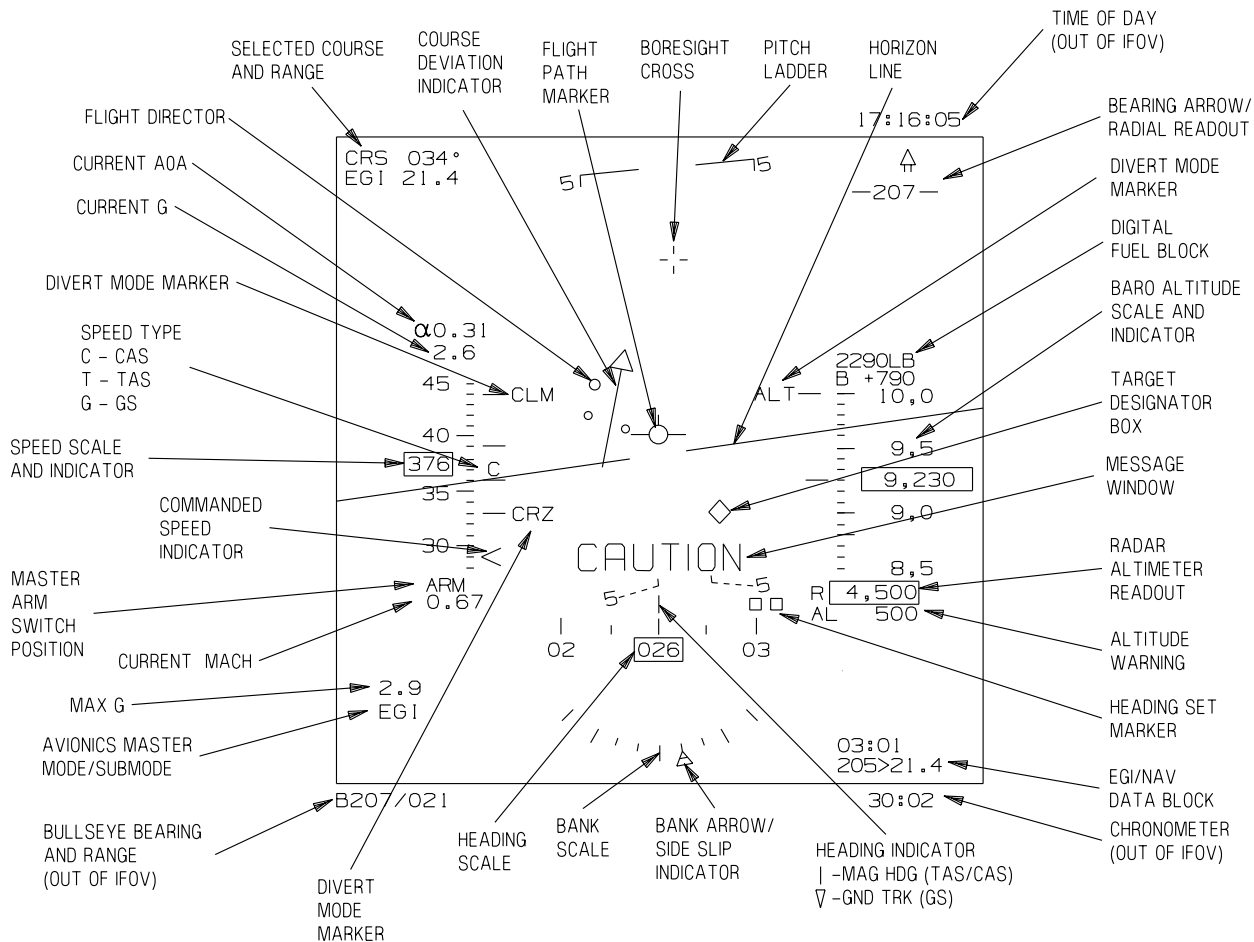
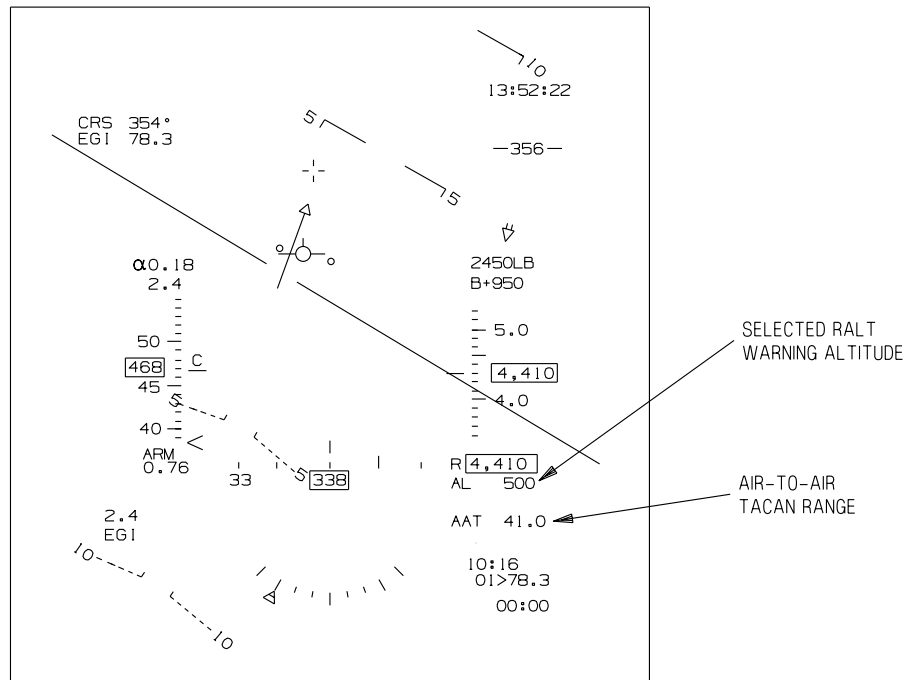

Figure 1-101. F-16 HUD

T38002-496-1-020



T38002-497-1-021

Figure 1-102. F-16 HUD AA Tacan Range/Altitude Warning

ALTITUDE WARNING

When Altitude Warning for either RALT or BOTH is selected via the UFCP ALT Key Display, the selected RALT warning altitude is displayed below the RALT indicator, Figure 1-102. It is displayed by up to four digits, with a leading AL to the left side. Both the AL and the digital value flash when the ALTITUDE warning is active. The AL label and data are removed when MSL or OFF is selected via the UFCP ALT Key Display.

AVIONICS MASTER MODE/SUBMODE BLOCK

The Avionics Master Mode/Submode Block is located at the lower left of the HUD display and presents the name of the Avionics Master Mode/Submode as follows:

- a. In the NAV Master Mode, the PNS selected (EGI/TCN/VOR/ILS/LOC/BC/FIP/FNL) is displayed.
- b. Refer to T.O. 1T-38C-34-1-1 for A/A and A/G Master Mode descriptions.

In the NAV Master Mode, with EGI as the PNS, Figure 1-103, the Master Mode/Submode Block displays the reported phase of flight from the EGI as follows:

- a. EGI APR : During a Non-Precision Approach.
- b. EGI TRM : During the Terminal Phase.
- c. EGI : All other phases of flight.

BANK SCALE/ARROW AND SLIP INDICATOR (NAV MODE ONLY)

The Bank Scale displays aircraft bank and consists of a curved bank scale and arrow. The Bank Scale consists of a center tic mark at 0° and four tick marks on both sides of the center tic mark representing 10°, 20°, 30° and 45° of aircraft bank.

The Bank Arrow is a triangle shaped symbol that indicates the magnitude and direction of the bank angle when read against the curved Bank Scale. The triangle moves around the arc so that its position relative to the tic marks indicates the bank angle of

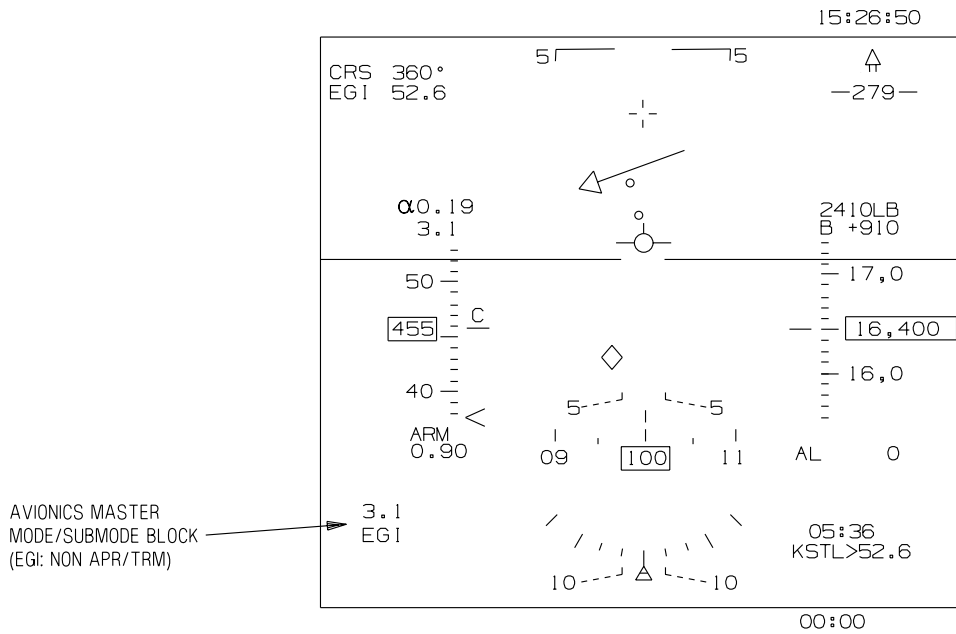

Figure 1-103. F-16 HUD Avionics Master Mode/Submode Block

T38002-498-1-020

the aircraft (i.e., aircraft banks left, triangle moves left). For bank angles greater than 45° a half triangle is displayed at the 45° tic mark. At this point triangle movement is limited.

The slip indicator is a trapezoid shape located below the Bank Arrow. The symbol indicates the magnitude and direction of the aircraft sideslip when read against the position of the Bank Arrow relative to the curved bank scale (sideslip indicator directionality is the same as other aircraft). As an example, with a bank angle of 30° and a side slip of 3° the triangle would be displayed at 30° and the trapezoid would be displayed at 33°, Figure 1-104. When there is no sideslip, the symbols are coincident.

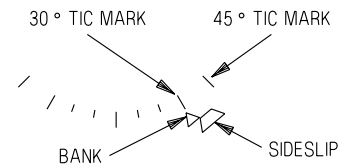

Figure 1-104. F-16 HUD Bank Scale/Arrow and Slip Indicator

T38002-499-1-020

NOTE

The Bank Scale/Arrow and Slip Indicator are only displayed in NAV Master Mode.

BAROMETRIC ALTITUDE SCALE AND INDICATOR

The barometric altitude of the aircraft is indicated on an altitude scale in an analog format, and continuously displays a range of 800 feet above and below the current aircraft altitude. Every 500 feet on the scale are marked by one digit (0 to 9999 feet) or two digits (10,000 feet and above) followed by a comma and the digit 0 (0 feet) or 5 (500 feet). Every 100 feet on the scale are marked by a short line, while every 500 feet are marked by a longer line.

The current aircraft altitude is displayed as a digital value surrounded with a box. The value is displayed to the nearest 10 feet with no leading zeros except when the altitude is zero (displayed as 000). The box has display priority at all times. Negative altitudes are displayed with a minus sign.

When altitude data is not available, the digital data is not displayed and the analog scale digits are removed.

The Divert Mode Altitude Marker is displayed with the label ALT when the divert profile is selected and the commanded cruise altitude is within the limits of the tape. ALT is removed from the display during the descent phase, Figure 1-105.

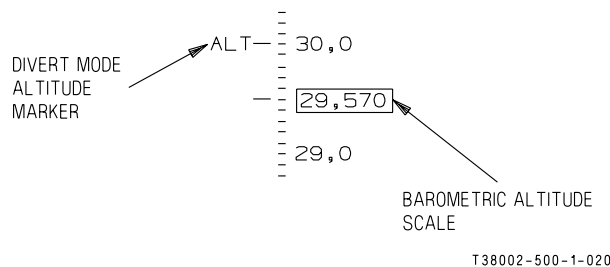

Figure 1-105. Barometric Altitude Scale and Indicator

BEARING ARROW/RADIAL READOUT

In NAV mode a relative Bearing Arrow, Reference Wings, and a Radial Readout referenced to the PNS are displayed in the upper right corner of the HUD FOV. The Bearing Arrow/Radial Readout provides the following data:

- a. If EGI/SCA (FIP/ FNL) is the PNS, the arrow indicates bearing to the EGI steerpoint, FIP point, or FNL point. The Radial Readout provides the magnetic radial from the selected EGI steerpoint, FIP point, or FNL point.
- b. If VOR is the PNS, the arrow indicates bearing to the VOR station. The Radial Readout provides the magnetic radial from the VOR station when a valid VOR signal is received.
- c. If TACAN or ILS/LOC/BC is the PNS, the arrow indicates bearing to the TACAN station. The Radial Readout provides the magnetic radial from the

TACAN station when a valid TACAN signal is received.

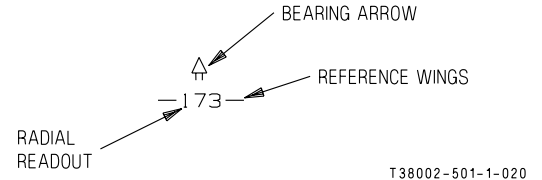

Figure 1-106. Bearing Arrow/Radial Readout

The Bearing Arrow and Radial Readout symbols are displayed only in NAV Master Mode. The arrow is above the Reference Wings whenever the relative bearing is in the forward hemisphere between right and left 90° positions. The arrow shifts to below the Reference Wings whenever the relative bearing is in the rear hemisphere. The Reference Wings bracket the digital Radial Readout and are always displayed parallel to the aircraft wings, Figure 1-106. The Bearing Arrow is not affected by selections made in the UFCP Bearing Arrow Sub-Menu Display. The source for the Bearing Arrow and Radial Readout on the HUD is determined by the PNS as follows:

PRIMARY NAVIGATION SOURCE	BEARING ARROW AND RADIAL SOURCE
EGI	EGI Steerpoint
SCA/FIP	EGI/FIP Steerpoint
SCA/FNL	EGI/FNL Steerpoint
VOR	VOR
TACAN (TCN)	TACAN
ILS/LOC/BC	TACAN

NOTE

When the source data driving the symbols is invalid (e.g., no VOR/TACAN signal or EGI in ATT mode), the Bearing Arrow, Reference Wings and Radial Readout symbols are removed from the display.

T.O. 1T-38C-1

HUD

BORESIGHT CROSS

The Boresight Cross (also referred to as Gun Cross) represents the aircraft water line.

BULLSEYE BEARING AND RANGE

Bullseye bearing and range information is displayed in all master modes when selected via the UFCP Bullseye Key Display. The bearing and range is from the bullseye to the ownship aircraft. The bearing and range are displayed on the HUD in the lower left corner just outside of the IFOV, Figure 1-101. The bearing and range format is BXXX/ XXX, with the bearing coming first and the range second. The bearing is displayed as 001-360° and the range as 000 to 999 nm.

CHRONOMETER TIME

The chronometer time is displayed below the IFOV in all master modes and is recorded on the VTR tape for display at debriefing.

COMMANDED SPEED INDICATORS

Manually Commanded Speed Caret

The Manually Commanded Speed Caret (also referred to as the Speed Bug) is displayed against the Speed Scale. The Speed Bug indicates the commanded speed entered on the UFCP SET Key Display and always matches the green tic mark on the MFD Airspeed Dial, Figure 1-107.

TOT Commanded Speed Marker

The TOT Commanded Speed Marker (-TOT) is displayed to the right of the Speed Scale. For display criteria, refer to UFCP DESTINATION (DST) FUNCTION KEY and/or UFCP FLIGHT PLAN (FPL) FUNCTION KEY, this section.

NOTE

If the commanded speed is outside the displayed Speed Scale range, the Speed Bug or TOT Commanded Speed Marker is fixed to the top or bottom of the Speed Scale IAW the respective speed.

Divert Mode Commanded Speed Markers

Divert Mode Commanded Speed Markers on the HUD Speed Scale display the divert climb speed (CLM) and cruise speed (CRZ). The markers are

displayed only when the divert mode is active. The CLM speed is displayed only when it is available and the divert profile is active. When Climb and Cruise Markers converge, the Cruise Marker is given display priority. The Cruise Marker label changes to descent speed (DES) when the aircraft enters the descent phase of the divert profile. See Figure 1-107. The Range Mode Marker on the HUD displays range speed (RNG) when in the Range Profile. The Endurance Mode Marker on the HUD displays endurance speed (END) when in the Endurance Profile. If the recommended profile speed is outside of the Speed Scale Display, the corresponding marker is removed from the Speed Scale Display, refer to GPS/INS BASED NAVIGATION, this section.

NOTE

The TOT and Divert Mode Commanded Speed Markers will display the commanded speed according to the selected display scale in any master mode.

COURSE DEVIATION INDICATOR (CDI)

When TCN, VOR, or EGI is the PNS, the HUD CDI is composed of a Dot Deflection Scale and a Course Arrow, Figure 1-108. The HUD CDI is only available in the NAV Master Mode.

The HUD CDI display rotates 360° around the FPM display relative to the selected course and aircraft heading.

The deviation is represented by the position of the CDI Course Arrow against the Deflection Dots and agrees with the CDI displayed on the MFD. Each dot represents 5° deviation from the selected course. No more than two dots are displayed at any time. When the deviation is more than 1.5 dots, two dots are shown on the same side of the HUD CDI. When deviation is between 0.5 and 1.5 dots, one dot is displayed on each side of the FPM (corresponding to the inner deflection dots on the MFD EHSI). When the deviation is less than 0.5, no dots are shown. For a deviation greater than two dots, the CDI Course Arrow is fixed slightly beyond the second dot. In the absence of a valid VOR or TCN signal, the CDI is removed.

When ILS, LOC, BC, or SCA is the PNS, the CDI (raw data) is a vertical, horizon-stabilized bar, placed at the same vertical position in the HUD as the FPM,

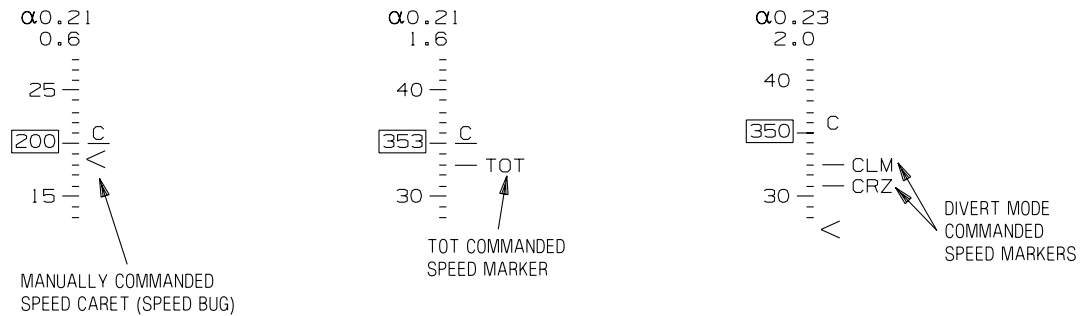
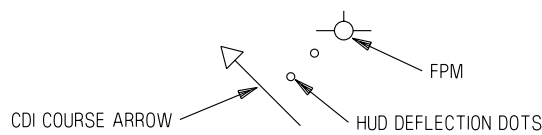

Figure 1-107. F-16 HUD Commanded Speed Indicators

T38002-502-1-020



T38002-503-1-020

Figure 1-108. F16 HUD Course Deviation Indicator

Figure 1-109. The scale for the CDI is displayed on the Vertical Deviation Indicator (VDI) and indicates the left/right deviation of the aircraft relative to the center of the localizer beam (ILS, LOC, or BC) or SCA course (i.e., if the CDI is right of center scale, the aircraft is to the left of the localizer beam). In the absence of a valid ILS signal, the CDI is dashed and centered over the FPM. When BC is the PNS, the VDI is removed and the scale is displayed centered on the FPM.

The CDI Scale has tic marks (corresponding to the MFD EHSI CDI dots) such that one tic deflection represents the following course deviation:

- a. For SCA - 1.25°.
- b. For ILS/LOC/BC - Half beam deflection.

The CDI maximum displacement (two tic marks) represents the following course deviations:

- a. For SCA - 2.5° or greater.

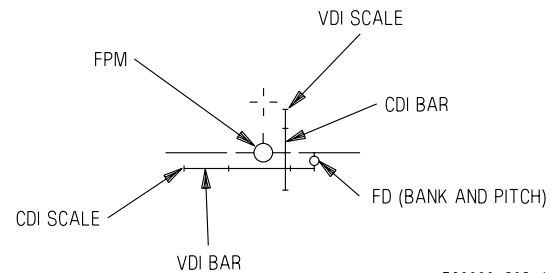

T38002-505-1-020

Figure 1-109. Vertical Deviation Indicator

- b. For ILS/LOC/BC - Full beam deflection or greater.

VERTICAL DEVIATION INDICATOR (VDI)

When ILS, LOC, or SCA is the PNS, the VDI Bar is displayed as a horizontal, horizon-stabilized bar and the VDI Scale is displayed on the HUD CDI Bar, Figure 1-109. Displacement of the VDI Bar above/below the HUD VDI Scale center depicts the relative aircraft position below/above the glideslope (e.g, Figure 1-109 depicts the aircraft above the glideslope).

The VDI Scale has tic marks (corresponding to the MFD EADI VDI dots) such that one tic deflection represents the following glideslope deviation:

- a. For SCA - 0.35°.
- b. For ILS and LOC - Half beam deflection.

T.O. 1T-38C-1 HUD

The VDI maximum displacement (two tic marks) represents the following glideslope deviation:

- a. For SCA - 0.7° or greater.
- b. For ILS and LOC - Full beam deflection or greater.

CURRENT AOA AND CURRENT G LOAD

The Current AOA and Current G Load are displayed above the HUD Speed Scale, Figure 1-110. The top row displays the Current AOA, preceded by the Alpha Symbol (α). AOA data is displayed from 0.00 to 1.10 α units in 0.01 increments. The bottom row displays the Current G Load from -9.9 to 9.9 g units in 0.1 increments.

α 0.23
2.0

T38002-506-1-020

Figure 1-110. F-16 HUD Current AOA and Current G Load

CURRENT MACH NUMBER

The Current Mach Number is displayed below the HUD Speed Scale from 0.00 to 3.00 in 0.01 increments.

2500LB
B+1000

T38002-507-1-020

Figure 1-111. F-16 HUD Digital Fuel Indicator

DIGITAL FUEL INDICATOR

The Digital Fuel Block, Figure 1-111 is displayed above the HUD Altitude Scale. It consists of two rows that provide the following indications:

- a. Total fuel quantity is displayed in the top row, followed by LB.
- b. The amount of fuel remaining above the set BINGO is displayed in the bottom row, preceded by

B+. If the fuel quantity is less than BINGO, this row is blanked.

NOTE

Due to MDP and EED software differences, the fuel quantity displayed in the HUD may be different than that displayed on the EED (the difference should not exceed 20 pounds). When these indications do not correspond, the EED is correct.

EGI/NAV DATA BLOCK

The EGI/NAV Data Block is displayed in the NAV and A/G Master Modes and consists of two rows containing EGI navigation information, Figure 1-112:

- a. The top row displays the Time To Go (TTG) to the steerpoint at the current GS. If the EGI is in ATT Mode, the label ATT is displayed in place of TTG. The display format is MM:SS with a range from 00:00 to 59:59.

- b. The bottom row displays the steerpoint identifier (waypoint number of the flight plan, DEST number, or ICAO ID). Following the steerpoint identifier is the symbol > followed by the distance to that steerpoint.

1. FPL Waypoint (e.g., 11 > 169.0) or ID (e.g., HOZ > 169.0).
2. DEST number 200 to 509 and 600 to 610 (e.g., 609 > 169.0).
3. Up to five digit ICAO ID (e.g., KRND > 169.0). The ICAO group letter A, W or N is not displayed. Refer to EMBEDDED GPS/INS (EGI), this section.

20:17
201>169.0

T38002-508-1-020

Figure 1-112. F-16 HUD EGI/NAV Data Block

FLIGHT DIRECTOR (FD)

The Flight Director (FD) is displayed when selected via the MFD or UFCP. Refer to UFCP BASIC MENU DISPLAY and MFD PFR OPTION SELECT BUTTONS (OSB) LABELS AND FUNCTIONS, this section.

When the PNS is EGI, VOR, TCN, LOC, or BC, the FD only provides bank commands to the selected course. When the PNS is ILS or SCA, the FD provides both bank and pitch commands to the selected course and glideslope.

There are two FD symbols on the HUD: bank steering only (Figure 1-113) and pitch/bank steering (Figure 1-114). The bank steering symbol is a circle shape. When the FD is providing only bank commands, it moves left or right along the HUD horizon line display. Its left/right position relative to FPM indicates the bank direction and its distance from the FPM indicates the amount of bank required. When the FD provides pitch and bank commands, a small tic mark is added to the circle shape and it is free to move off the horizon line. When the aircraft is flown such that the FD symbol is placed in the center of the FPM, the correct amount of bank and/or pitch is achieved. Refer to FLIGHT DIRECTOR LOGIC AND USAGE, this section.



Figure 1-113. F-16 HUD FD with Bank Only Commands



Figure 1-114. F-16 HUD FD with Bank and Pitch Commands

FLIGHT PATH MARKER (FPM)

The FPM represents the aircraft velocity vector within the HUD TFOV.

When the FPM symbol does not indicate the aircraft velocity vector (e.g., during the EGI alignment state, or when it reaches the display boundaries), an X is displayed in the center of the FPM.

FPM left-right movement (drift) can be controlled via the UFCP HUD Key Display. When DCO is selected, the operation of all symbols that are used in combination with the FPM (e.g., the pitch ladder, heading/

flight director, ILS and SCA localizer and glideslope symbols) remain at a relative position in relation to the FPM.

HEADING SCALE AND INDICATOR

The Heading Scale presents $\pm 10^\circ$ (20° total) in magnetic azimuth off aircraft heading. Every 10° within this range is annotated by a tic mark with two digits below it, representing hundreds and tens of degrees respectively. Every 5° is marked by a shorter tic mark without digits (Figure 1-115).

The Magnetic Heading Digital Readout box displays three digits to the nearest degree (001- 360) in a fixed position centered under the Heading Indicator. Digits that mark every 10° are blanked when they touch the digital readout box, which always has display priority

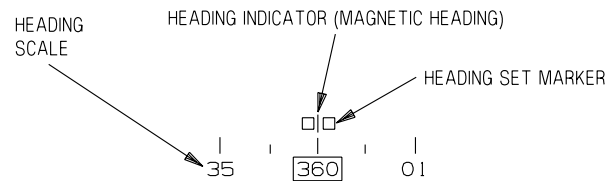

Figure 1-115. F-16 HUD Heading Scale and Indicator

When CAS or TAS is selected for the Speed Scale, the Heading Indicator consists of a tic mark (|) and indicates present magnetic heading. When GS is selected for the Speed Scale, magnetic ground track is displayed and the Heading Indicator is a triangle symbol (∇), Figure 1-101.

The Heading Scale and Indicator appear in all modes. The Heading Scale is displayed in the upper portion of the HUD when in A/G Master Mode, A/A Master Mode or NAV Master Mode (landing gear down). The Heading Scale is displayed in the lower portion of the HUD only when in NAV Master Mode with the landing gear up.

HEADING SET MARKER

The Heading Set Marker, Figure 1-115, indicates the heading that is manually set via the UFCP SET Key Display or MFD HDG Rocker Switch. The display

**T.O. 1T-38C-1
HUD**

consists of two small adjacent squares. If the set heading is outside the display scale limits, the Heading Set Marker is removed.

HORIZON LINE

The Horizon Line is a solid line that extends the entire width of the TFOV with a gap in the center. It is occluded by the Speed and Altitude Scales. The Ghost Horizon Line (Figure 1-116) is a dashed line that is displayed whenever the horizon line is out of the field of view. Its position indicates the direction and orientation of the true horizon.

NOTE

The Horizon Line and Ghost Horizon Line are displayed simultaneously during transition between the two.

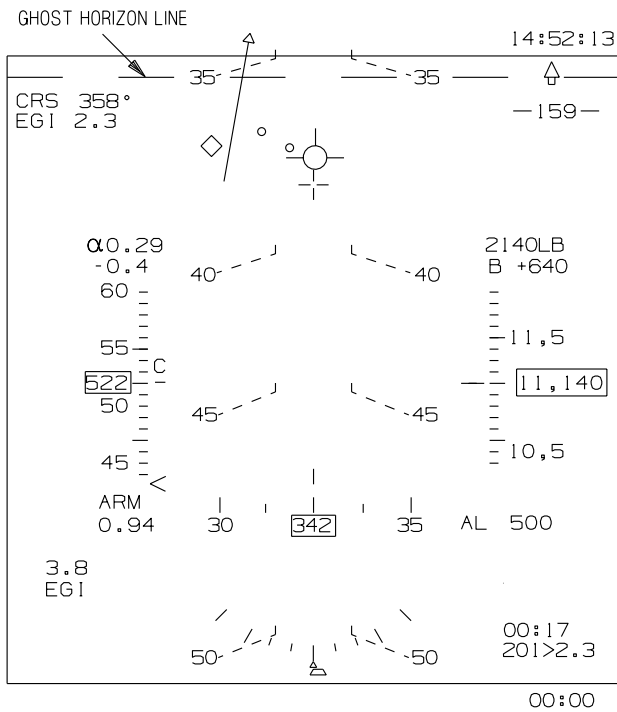

Figure 1-116. Ghost Horizon Line F-16 HUD

MAX G LOAD DATA BLOCK

The Max G Load Data Block displays the maximum positive g performed by the aircraft (#.#) since last reset. The G is reset to 1.0 during initial takeoff and it

can be reset via the MFD if the aircraft has not experienced an over g. Refer to MULTIFUNCTIONAL DISPLAY (MFD), this section.

MESSAGE WINDOW

WCA messages are displayed in this window. The window is located in the lower half of the HUD when the landing gear is up. Refer to F-16 HUD GEAR DOWN SYMBOLS, this section.

ZENITH/NADIR SYMBOLS

The Zenith/Nadir (90° of climb/dive) are displayed as a circle indicating the 90° point of the climb or dive, Figure 1-117. The symbols represent the location of the 90° climb/dive point only and appear in the HUD IFOV when approaching 75° - 85° of climb/dive.



Figure 1-117. Zenith/NADIR Symbols

T38002-570-1-020

PITCH LADDER

The Pitch Ladder is a set of roll stabilized lines, parallel to the horizon, that indicate pitch angles relative to the horizon within the HUD IFOV. The Pitch Ladder consists of climb/dive bars with numeric labels and a horizon line.

The Pitch Ladder displays the aircraft climb/dive and roll angle when read relative to the FPM. The Pitch Ladder is displayed laterally to the FPM. The lines are drawn on the display at 5° intervals from -85° to +85°. The climb lines are straight and the dive lines are angled at 1/2 the pitch angle (e.g., 20° dive lines are angled at 10°). Solid lines represent positive values of climb with outer elbows pointing down towards the horizon and dashed lines represent dive angles with inner elbows pointing up towards the horizon. Numerals representing the value of climb/dive associated with each line are drawn beyond the edge of each line.

RADAR ALTIMETER (RALT) READOUT

The RALT readout displays current altitude above the terrain and is indicated by one to four digits (boxed) in increments of 10 feet, preceded by an R,

T38002-512-1-020

Figure 1-101. The box, digits, and the R are not displayed if RALT data is not available because of the following reasons:

- a. No altitude received from the RALT due to a system malfunction.
- b. AGL altitude is greater than 5000 feet or the aircraft is banked more than 45°.
- c. The aircraft is on the ground with WOW.
- d. RALT OFF (deselected via UFCP EGI Key Display or by selecting POD on MFD WPN Display Page).

SELECTED COURSE AND RANGE

The Selected Course and Range data is displayed in NAV Master Mode, Figure 1-101, and shows the selected course and range to the selected PNS. The Selected Course is displayed by three digits with values ranging from 001-360. Range is displayed by up to four digits (no leading digits) with one digit after the decimal point (in the range 0.0-999.9). The source of the range data is described below:

PRIMARY NAVIGATION SOURCE	DIGITAL RANGE SOURCE	RANGE PREFIX DISPLAYED
TACAN	TACAN	TCN
VOR	VOR paired DME	VOR
EGI/SCA	EGI	EGI
ILS/LOC/BC with ILS selected in window 4 of the UFCP NAVAID Sub-Menu Display	ILS paired DME	ILS
ILS/LOC/BC with TCN selected in window 4 of the UFCP NAVAID Sub-Menu Display	TACAN	ILS

NOTE

- With TCN as the PNS and AAT selected, the digital range on the HUD is blank and the range prefix is TCN.
- In NAV backup with ILS as the PNS, the digital range source for the HUD is always the TACAN channel displayed on the TACAN Backup Control Panel. However, the digital range displayed next to the I in the range data block of the MFD Backup Display is always the ILS paired DME range.
- In NAV backup with TCN or ILS as the PNS, the digital range on the HUD is

blank when the TACAN is in A/A mode. This should only occur when the aircrew selects A/A on the TACAN Backup Control Panel.

The HUD Selected Course and Range data parallels the MFD displays for CRS and range.

SPEED SCALE AND INDICATOR

Aircraft speed is indicated on a scale in an analog format, continuously presenting a range of 80 knots below and above the current aircraft speed. Every 10 knots on the scale is marked by a short line, while every 50 knots is marked by a longer line alongside one to two digits representing hundreds and tens of knots (for example, 5 = 50 knots, 10 = 100, 15 = 150,

T.O. 1T-38C-1

HUD

etc.). The speed scales available for display are calibrated airspeed (CAS), true airspeed (TAS) or ground speed (GS). The speed scales vary according to the selected avionics master mode as follows:

a. NAV: Default display is CAS. GS and TAS may be selected via the UFCP HUD Key Display.

b. A/A: Displayed in CAS only.

c. A/G: Default display is CAS. TAS may be selected via the UFCP WPN Display. Refer to T.O. 1T-38C-34-1-1.

The current speed of the aircraft is indicated on the center of the speed scale. It is also marked by a short horizontal line to the right of the scale. A letter which indicates the type of speed is displayed above the speed indicator line (C for CAS, T for TAS, and G for GS).

The digital value of the current speed is displayed at all times in a box at the center of the speed scale and has display priority over the scale numerical indicators. The speed is displayed to the nearest knot with no leading zeros, except when the speed is zero (displayed as 000). When speed is below 30 knots CAS, the digital data indicates zero.

When speed data is not available, the digital data is not displayed and the analog scale is displayed at zero.

TARGET DESIGNATOR (TD) BOX

The TD Box is displayed on the steerpoint at its coordinates and elevation in the NAV and A/G Master Modes.

When the line of sight to the steerpoint is out of the display limits of the HUD TFOV, the symbol is displayed in the direction of the steerpoint with an X in its center.

NOTE

If no elevation exists for the steerpoint, the TD Box is displayed on the horizon.

TIME OF DAY (TOD)

The TOD is constantly displayed in the upper right corner of the HUD TFOV in all Master Modes.

MASTER ARM SWITCH POSITION

The Master Arm Switch Position is displayed below the HUD Speed Scale in all Master Modes and indicates the Master Arm status (SAFE or ARM). Refer to T.O. 1T-38C-34- 1-1.

F-16 HUD GEAR DOWN SYMBOLS

The following HUD symbology, Figure 1-118 is displayed only with the landing gear down.

NOTE

In the event of RCP nose gear indication circuitry failure to the MDP; the STALL warning is not available (refer to Warning/Caution/Advisory (WCA) System, this section), gear down symbology on the HUD is not displayed (Refer to F-16 HUD Gear Down Symbols, this section and MIL-STD HUD Gear Down Symbols, this section), and the MDP automatic speed calculation is disabled.

2.5° DESCENT REFERENCE LINE

A 2.5° Descent Reference Line is added to the pitch ladder display, Figure 1-118.

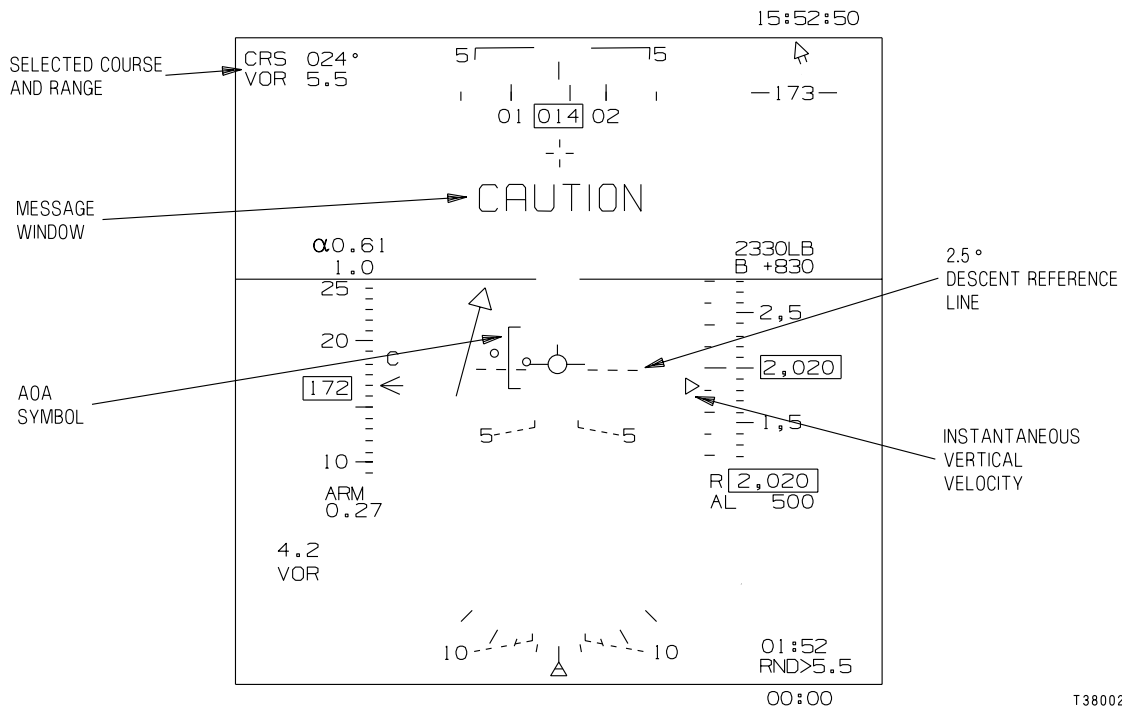

Figure 1-118. F-16 HUD Landing Gear Down Symboly

T38002-513-1-020

SPEED SCALE

The Speed Scale automatically switches to CAS units and cannot be changed as long as the landing gear remains lowered.

AOA SYMBOL

The AOA symbol (the Staple) is added to the HUD display and moves horizontally with the FPM. The Staple display range is 0.55 (top) to 0.65 (bottom), Figure 1-119. The FPM at the center of the Staple represents an AOA of 0.6. Display of AOA continues in linear fashion outside the range of the Staple (e.g., for an AOA of 0.40, the top of the AOA symbol is placed below the center of the FPM a distance corresponding to one half of the symbol's total length).

COMMANDED SPEED INDICATOR (SPEED BUG)

The manual Speed Bug Caret is replaced with the auto Speed Bug Caret and replaces the TOT commanded speed, if selected. Aircrew can override the

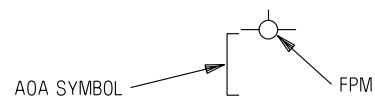

Figure 1-119. AOA Symbol

T38002-514-1-020

auto Speed Bug and/or reselect TOT via the UFCP, refer to UFCP FUNCTION KEYS, this section.

HEADING SCALE AND INDICATOR

The Heading Scale is displayed at the top of the HUD.

MESSAGE WINDOW

The Message Window is displayed in the upper half of the HUD.

TARGET DESIGNATOR (TD) BOX

The TD Box is only displayed in NAV or A/G Master Modes when the steerpoint is DEST 500 - 509.

T.O. 1T-38C-1
HUD

INSTANTANEOUS VERTICAL VELOCITY (IVV)

The HUD IVV (triangle and scale) is displayed to the left of the Altitude Scale. Reference tic marks are spaced at +/-500 feet per minute (fpm) intervals. Longer tic marks indicate the +/-1000 fpm intervals. The scale range presents vertical velocity between +2000 and -2000 fpm. When the triangle is in the center of the scale, it indicates zero vertical velocity. See Figure 1-120. For vertical velocities exceeding +/-2000 fpm, the triangle will be displayed at the corresponding scale limit.

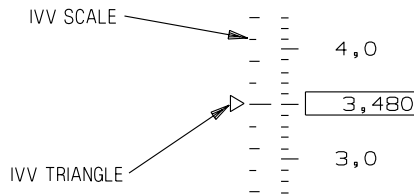

T38002-515-1-020

Figure 1-120. F-16 HUD Instantaneous Vertical Velocity

F-16 HUD DECLUTTER

The ability to remove non-essential symbology from the HUD is provided by the UFCP DCL Function Key. The mission planning file loaded via the DTS defines the specific symbology removed when declutter is selected for each master mode, respectively.

The following items can be pre-selected, prior to flight, for removal from the HUD via mission planning software.

SYMBOL	MASTER MODE		
	NAV	A/A	A/G
Current G	X	X	X
Max G	X	X	X
Mach No	X	X	X
Total Fuel	X	X	X
Bingo Fuel	X	X	X
RALT	X	X	X
Altitude Alert	X	X	X
Safe/Arm Display	X		
TD Box	X		X
EGI Data Block			X
AOA		X	X
Bullseye	X	X	X

Refer to UFCP FUNCTION KEYS, this section.

MIL-STD HUD BASIC SYMBOLS

The MIL-STD HUD basic symbols are shown in Figures 1-121, 1-122, and FO-6.

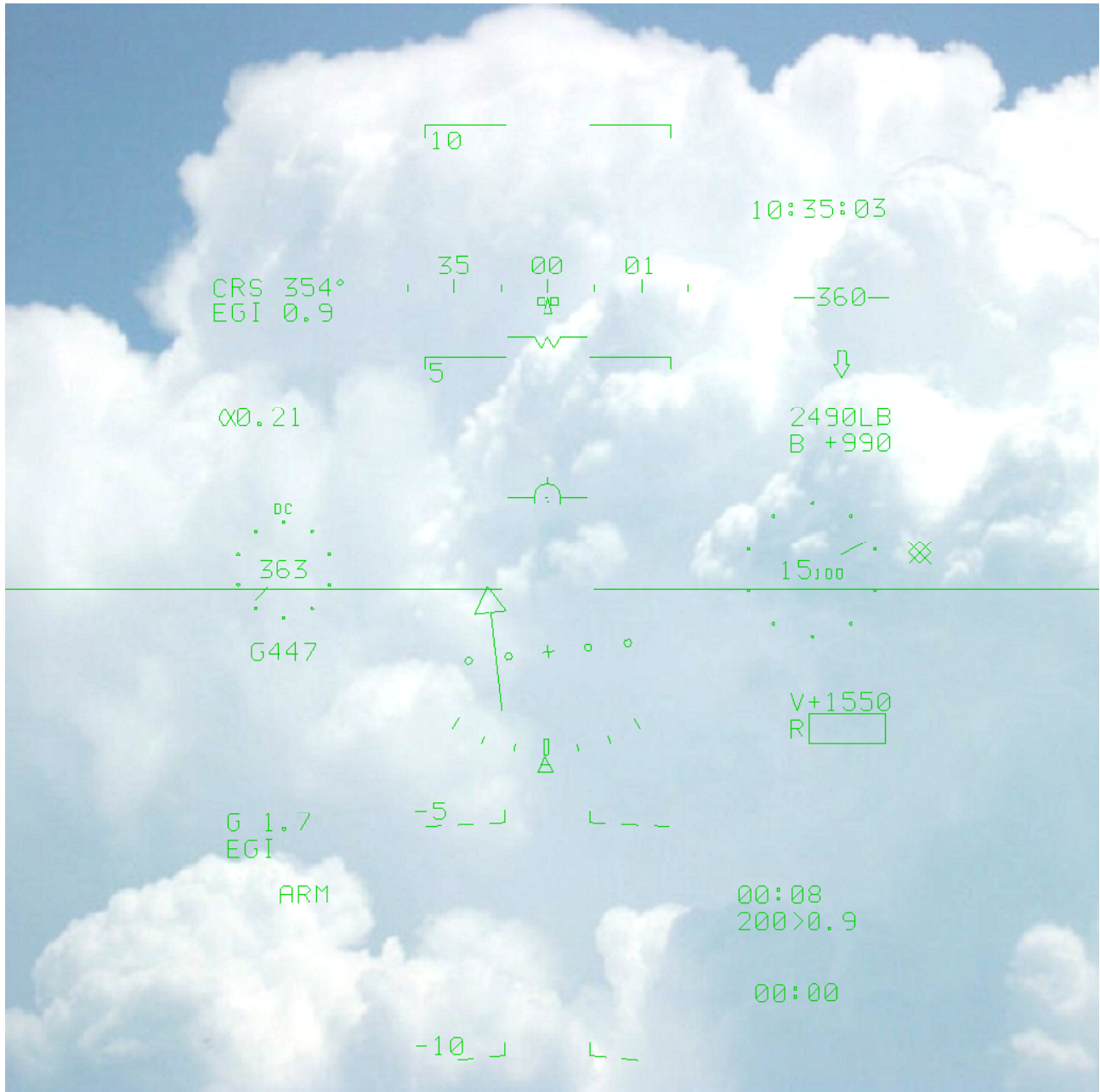

Figure 1-121. MIL-STD HUD

T38002-494-1-020

**T.O. 1T-38C-1
HUD**

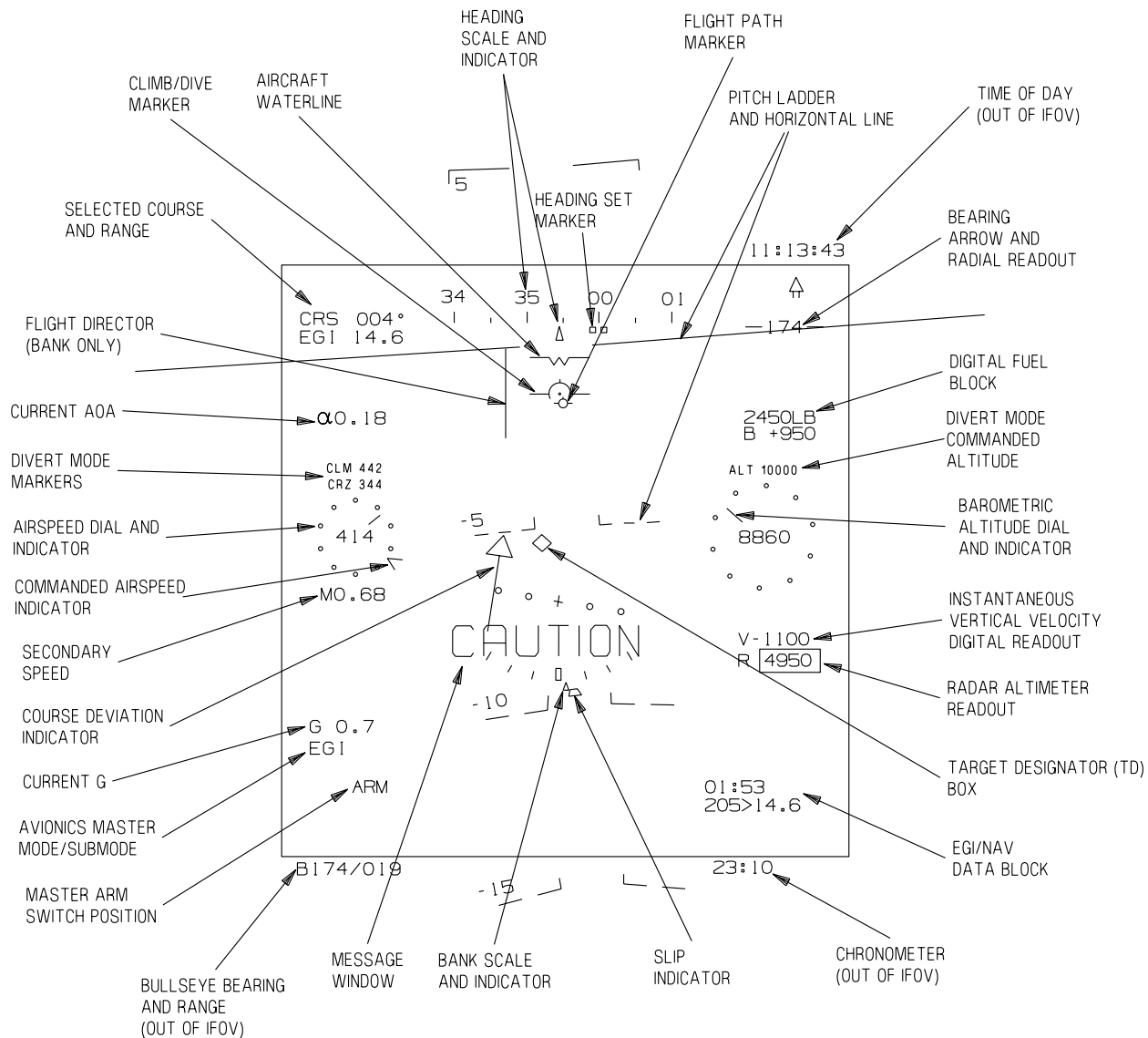
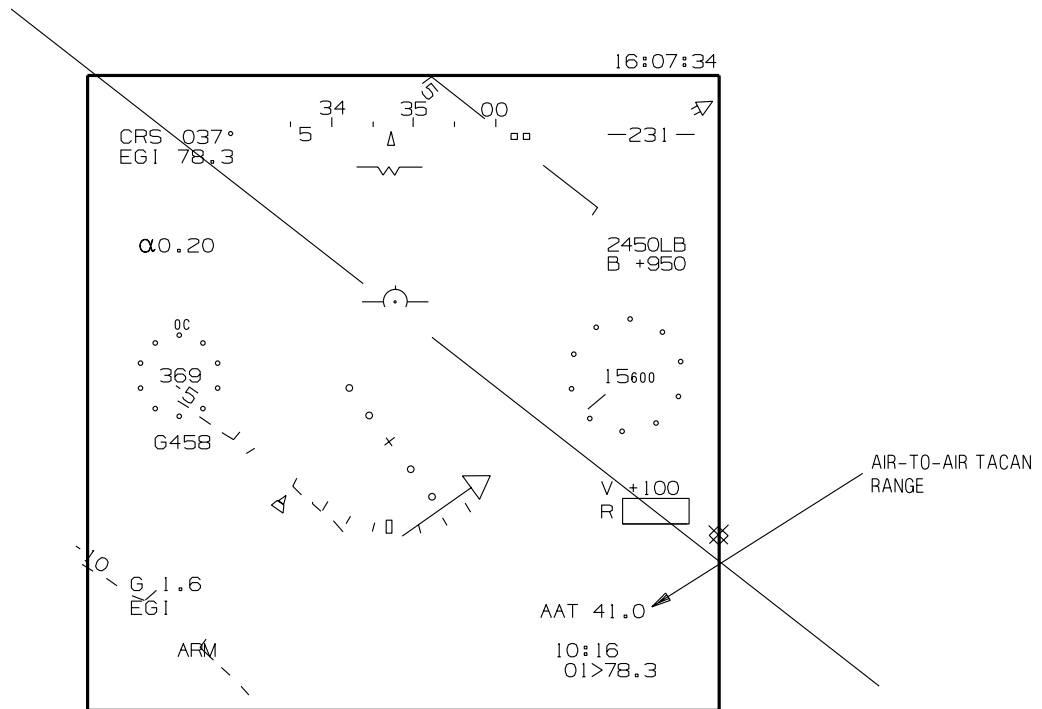

Figure 1-122. MIL-STD HUD Basic Symbology

T38002-516-1-020



T38002-517-1-020

Figure 1-123. MIL-STD HUD Air-to-Air Tacan Range

AIR-TO-AIR TACAN RANGE

When the TACAN receiver is in A/A mode, the A/A TACAN range is displayed in the lower right corner of the HUD. The display reads AAT followed by the A/A TACAN range. The range is displayed above the EGI/NAV Data Block, Figure 1-123.



Under dynamic conditions (i.e., high rates of closure or separation), displayed AAT ranges may differ greatly from actual slant ranges between aircraft.

NOTE

If there is no range reception, the prefix AAT is displayed, but the range is blank.

AIRCRAFT WATERLINE

The Aircraft Waterline is a W shaped symbol that represents the aircraft water line, Figure 1-124. The top portion of the W is aligned to the aircraft wings and is laterally centered to the HUD IFOV. It appears only in NAV mode.



T38002-518-1-020

Figure 1-124. Aircraft Waterline

AIRSPPEED DIAL AND DIGITAL READOUT

The Airspeed Dial and Digital Readout always display the calibrated airspeed regardless of the selected master mode.

The Airspeed Dial consists of 10 bold dots equally spaced around a circle and an index pointer. Each dot represents 10 knots, starting at 12 o'clock. The

**T.O. 1T-38C-1
HUD**

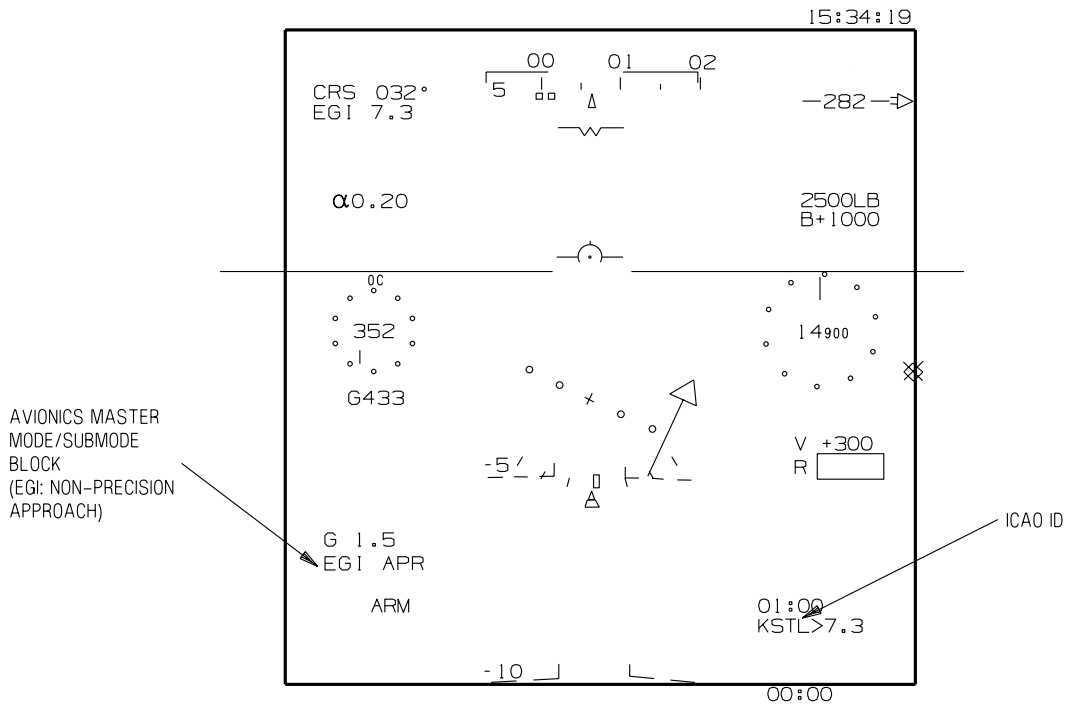

Figure 1-125. MIL-STD HUD Avionics Master Mode/Submode Block

T38002-519-1-020

pointer makes one complete revolution for every 100 knots. It moves clockwise for increasing speed and counter clockwise for decreasing speed.

The Airspeed Digital Readout is composed of one to three digits displayed at the Airspeed Dial center without leading zeros. The readout resolution is to the nearest knot and indicates zero when the airspeed is below 30 knots. When airspeed data is not available, the Digital Readout is not shown.

AVIONICS MASTER MODE/SUBMODE BLOCK

The Avionics Master Mode/Submode Block is located at the lower left of the HUD display and presents the name of the Avionics Master Mode/Submode mode as follows:

- a. In the NAV Master Mode, the PNS selected (EGI/TCN/VOR/ILS/LOC/BC/FIP/FNL) is displayed.
- b. Refer to T.O. 1T-38C-34-1-1 for A/A and A/G Master Mode descriptions.

In the NAV Master Mode with EGI as the PNS, Figure 1-125, the Master Mode/Submode Block displays the reported phase of flight from the EGI as follows:

- a. EGI APR : During a Non-Precision Approach.
- b. EGI TRM : During the Terminal Phase.
- c. EGI : All other phases of flight.

BANK SCALE/ARROW AND SLIP INDICATOR (NAV MODE ONLY)

The Bank Scale displays aircraft bank and consists of a curved bank scale and arrow. The Bank Scale consists of a center tic mark at 0° and three tic marks at 10° intervals on both sides of the center tic mark, representing 10°, 20°, and 30° of aircraft bank.

The bank arrow is a triangle shaped symbol that indicates the magnitude and direction of the bank angle when read against the curved Bank Scale. The triangle moves around the arc so that its position relative to the tic marks indicates the bank angle of the aircraft (i.e., aircraft banks left, triangle moves

left). For bank angles greater than 25°, additional tic marks are displayed at 45° and 60° on the same side of the scale as the bank arrow. For bank angles greater than 55°, additional tic marks are displayed at 90° and 135° on the same side of the scale as the bank arrow. Refer to Figure 1-126.

NOTE

The Bank Scale location is usually near the center of the HUD, at the horizontal level of the Radar Altimeter. The location of the scale shifts down to maintain separation from the FPM and the Climb/Dive Marker (CDM) when the FPM is in the lower portion of the HUD.

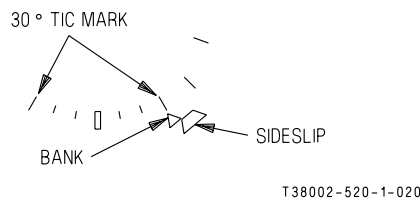

Figure 1-126. MIL-STD HUD Bank Scale/Arrow and Slip Indicator

The slip indicator is a trapezoid shape located below the Bank Arrow. The symbol indicates the magnitude and direction of the aircraft sideslip when read against the position of the Bank Arrow relative to the curved bank scale (sideslip indicator directionality is the same as other aircraft). As an example, with a bank angle of 30° and a side slip of 3° the triangle would be displayed at 30° and the trapezoid would be displayed at 33°, Figure 1-126. When there is no sideslip, the symbols are coincident.

NOTE

The Bank Scale/Arrow and Slip Indicator are only displayed in NAV Master Mode.

BAROMETRIC ALTITUDE DIAL AND INDICATOR

The barometric altitude of the aircraft is indicated by an altitude dial consisting of 10 bold dots equally spaced around a circle and an index pointer, Figure 1-129. Each dot represents 100 feet, starting at 12 o'clock. The pointer makes one complete revolution

every 1000 feet. It moves clockwise for increasing altitude and counter clockwise for descending altitude.

The current aircraft altitude is displayed as a digital value located at the dial center with no leading zeroes. When the altitude is equal to or greater than 10,000 feet, the three last digits are displayed at 60% of the normal size and the readout resolution is to the nearest 100 feet. When the altitude is less than 10,000 feet, all the digits are displayed at the normal size and the readout resolution is to the nearest 10 feet. Negative altitudes are displayed with a minus sign.

When altitude data is not available, the digital data is not shown and the pointer is removed.

BEARING ARROW/RADIAL READOUT

In NAV mode a relative Bearing Arrow, Reference Wings, and a Radial Readout referenced to the PNS are displayed in the upper right corner of the HUD FOV. The Bearing Arrow/Radial Readout provides the following data:

- a. If EGI/SCA (FIP/ FNL) is the PNS, the arrow indicates bearing to the EGI steerpoint, FIP point, or FNL point. The Radial Readout provides the magnetic radial from the selected EGI steerpoint, FIP point, or FNL point.
- b. If VOR is the PNS, the arrow indicates bearing to the VOR station. The Radial Readout provides the magnetic radial from the VOR station when a valid VOR signal is received.
- c. If TACAN or ILS/LOC/BC is the PNS, the arrow indicates bearing to the TACAN station. The Radial Readout provides the magnetic radial from the TACAN station when a valid TACAN signal is received.

The Bearing Arrow and Radial Readout symbols are displayed only in NAV Master Mode. The arrow is above the Reference Wings whenever the relative bearing is in the forward hemisphere between right and left 90° positions. The arrow shifts to below the Reference Wings whenever the relative bearing is in the rear hemisphere. The Reference Wings bracket the digital Radial Readout and are always displayed parallel to the aircraft wings, Figure 1-106. The Bearing Arrow is not affected by selections made in the UFCP Bearing Arrow Sub-Menu Display. The source for the Bearing Arrow and Radial Readout on the

**T.O. 1T-38C-1
HUD**

HUD is determined by the PNS as follows:

PRIMARY NAVIGATION SOURCE	BEARING ARROW AND RADIAL SOURCE
EGI	EGI Steerpoint
SCA/FIP	EGI/FIP Steerpoint
SCA/FNL	EGI/FNL Steerpoint
VOR	VOR
TACAN (TCN)	TACAN
ILS/LOC/BC	TACAN

NOTE

When the source data driving the symbols is invalid (e.g., no VOR/TACAN signal or EGI in ATT mode), the Bearing Arrow, Reference Wings and Radial Readout symbols are removed from the display.

BULLSEYE BEARING AND RANGE

Bullseye bearing and range information is displayed in all master modes when selected via the UFCP Bullseye Key Display. The bearing and range is from the bullseye to the ownship aircraft. The bearing and range are displayed on the HUD in the lower left corner just outside of the IFOV, Figure 1-122. The bearing and range format is BXXX/XXX, with the bearing coming first and the range second. The radial is displayed as 001°-360° and the range as 000-999 nm.

COMMANDED AIRSPEED INDICATORS

Manual/TOT Comanded Airspeed Indicator

The Manual/TOT Comanded Airspeed Indicator indicates System Generated TOT when available or the Manual Speed set via the UFCP. Refer to UFCP SET FUNCTION KEY, this section.

The Manual/TOT Comanded Airspeed Indicator, Figure 1-127, consists of either a caret or a digital readout as follows:

a. The caret is an arrowhead shaped symbol located on the outside edge of the dial and points towards the dial center. It indicates the commanded velocity when the difference between the commanded velocity and the current airspeed is less than 40 knots.

b. The Digital Readout is located above the dial. It displays the commanded speed when the difference between the commanded speed and the current airspeed is greater than 40 knots.

c. The commanded velocity is always calibrated airspeed. This is indicated by the letter C which follows the digital readout.

NOTE

The caret and digital readout are not displayed at the same time.

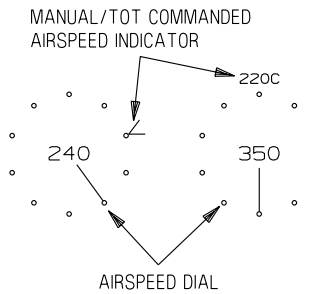

T38002-521-1-020

Figure 1-127. MIL-STD HUD Manual/TOT Comanded Airspeed Indicator

Divert Mode Comanded Speed Indicators

The MIL-STD HUD digital readouts display the Divert Mode Markers Climb Speed (CLM), and Cruise Speed (CRZ) above the CVI Digital Readout. These values are displayed whenever the Divert Mode is active, Figure 1-128. The CLM speed is displayed only when it is available and Divert Profile is selected. The CRZ label changes to DES when the aircraft is in the Descent Phase of the Divert Profile. The digital readout changes to RNG when the Range Profile is selected, and END when the Endurance Profile is selected.

SECONDARY SPEED DISPLAY

The Secondary Speed digital readout is displayed below the Airspeed Dial and consists of one of the following:

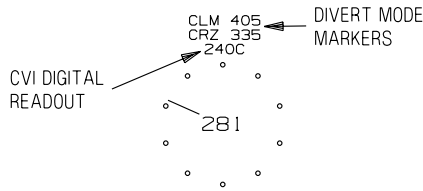

T38002-522-1-020

Figure 1-128. MIL-STD HUD Divert Mode Commanded Speed Indicators

- a. Mach (MAC) (M plus three digits to the nearest hundredth - X.XX).
- b. Ground Speed (G plus three digits to the nearest knot).
- c. True Airspeed (T plus three digits to the nearest knot).

For UFCP MIL-STD mode selection and default displays, refer to UFCP FUNCTION KEYS, this section.

DIVERT MODE COMMANDED ALTITUDE INDICATOR

The Divert Mode Commanded Altitude Indicator is displayed above the Altitude Dial when the Divert Profile is selected. The Digital Divert Mode Altitude is preceded by ALT, Figure 1-129, and removed during the Descent Phase.

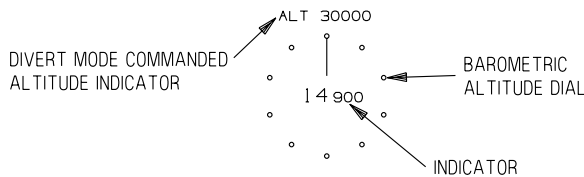

T38002-523-1-020

Figure 1-129. MIL-STD HUD Divert Mode Commanded Altitude Indicator

CHRONOMETER TIME

The chronometer time is displayed below the IFOV in all master modes and is recorded on the VTR tape for display at debriefing.

CLIMB/DIVE MARKER (CDM)

The CDM represents the aircraft climb/dive vector. It is horizontally fixed to the centerline of the IFOV and is free to move vertically within the IFOV. If the actual position is outside the IFOV (e.g., HUD display limited), the CDM symbol is replaced by a dashed CDM that is displayed on the IFOV boundary.

The CDM and FPM are displayed together in the MIL-STD HUD. When the CDM and FPM symbols overlap, the CDM symbol has display priority over the FPM.

COURSE DEVIATION INDICATOR (CDI)

For all PNS's the CDI is composed of the course arrow, four dots and the + symbol which marks the center, Figure 1-130. The CDI is positioned just above the Bank Scale. The dots and the course arrow rotate 360° around the + symbol, according to the angle between A/C heading and the selected course. The CDI is only available in the NAV Master Mode.

The deviation is represented by the position of the arrow when read against the dots, and agrees with the CDI displayed on the MFD. All four dots are always displayed. Each dot represents the following deviation:

- a. For SCA - 1.25°.
- b. For ILS/LOC/BC - Half beam deflection.
- c. TCN/VOR/EGI - 5°.

The maximum deflection of the arrow is 2.4 dots.

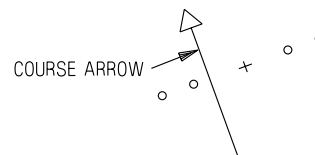

T38002-524-1-020

Figure 1-130. MIL-STD HUD Course Deviation Indicator

CURRENT AOA

The current AOA is located above the Airspeed Dial and is preceded by the Alpha Symbol (α), Figure

T.O. 1T-38C-1
HUD

1-131. AOA data is displayed from 0.00 to 1.10 with 0.01 unit increments.

α0.34

T38002-525-1-020

Figure 1-131. MIL-STD HUD Current AOA

CURRENT G LOAD

The Current G Load Block is located below the Airspeed Dial and displays the current G Load on the aircraft. The G Load is displayed from -9.9 to 9.9 g units in 0.1 increments.

DIGITAL FUEL INDICATOR

The Digital Fuel Block is located above the Altitude Dial, Figure 1-132. It consists of two rows that provide the following indications:

a. Total fuel quantity is displayed in the top row, followed by LB.

b. The amount of fuel remaining above the set BINGO is displayed in the bottom row. It is preceded by B+. If fuel quantity is less than BINGO, this row is blanked.

NOTE

Due to MDP and EED software differences, the fuel quantity displayed in the HUD may be different than that displayed on the EED (the difference should not exceed 20 pounds). When these indications do not correspond, the EED is correct.

2490LB
 B +990

T38002-526-1-020

Figure 1-132. MIL-STD HUD Digital Fuel Indicator
EGI/NAV DATA BLOCK

The EGI/NAV Data Block is displayed in the NAV and A/G Master Modes and consists of two rows containing EGI navigation information, Figure 1-133:

a. The top row displays the Time To Go (TTG) to the steerpoint at the current GS. If the EGI is in the ATT mode, the label ATT is displayed in place of TTG. The display format is MM:SS with a range from 00:00 to 59:59.

b. The bottom row displays the steerpoint identifier (waypoint number of the flight plan, DEST number, or ICAO ID). Following the steerpoint identifier is the symbol > followed by the distance to that steerpoint.

1. FPL Waypoint (e.g., 11 > 169.0) or ID (e.g., HOZ > 169.0).
2. DEST number 200 to 509 and 600 to 610 (e.g., 609 > 169.0)
3. Up to five digit ICAO ID (e.g., KRND > 169.0). The ICAO group letter A, W or N is not displayed. Refer to EMBEDDED GPS/INS (EGI), this section.

20:17
 201>169.0

T38002-527-1-020

Figure 1-133. MIL-STD HUD EGI/NAV Data Block
FLIGHT DIRECTOR (FD)

The Flight Director (FD) is displayed when selected via the MFD or UFCP. Refer to UFCP BASIC MENU DISPLAY and MFD PFR OPTION SELECT BUTTONS (OSB) LABELS AND FUNCTIONS, this section.

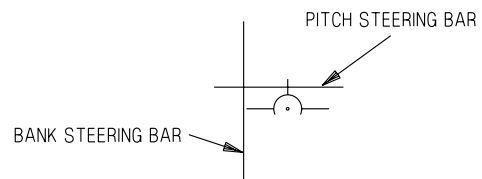

T38002-528-1-020

Figure 1-134. MIL-STD HUD Flight Director

There are two Flight Director steering bar symbols available on the HUD, the Flight Director Bank Steering Bar and the Flight Director Pitch Steering Bar, Figure 1-134. When the PNS is EGI, VOR, TCN, LOC, or BC, the bank steering bar provides bank commands to the selected course. When the PNS is

ILS or SCA, the Bank and Pitch Steering Bars provide both bank and pitch commands to the selected course and glideslope.

The Bank Steering Bar moves left and right relative to the CDM symbol. It's left/right position relative to the CDM symbol indicates the bank direction (if the bar is left, left bank is required, and vice versa) and it's distance from the CDM symbol indicates the amount of bank required.

The Pitch Steering Bar moves up and down relative to the CDM Symbol. It's up/down position relative to the CDM Symbol indicates the pitch direction (if the bar is up, nose-up pitch is required, and vice versa) and it's distance from the CDM Symbol indicates is the amount of pitch required.

When the aircraft is flown such that the FD steering bar symbols are placed in the center of the CDM, the correct amount of bank and/or pitch is achieved. Refer to FLIGHT DIRECTOR LOGIC AND USAGE, this section.

FLIGHT PATH MARKER (FPM)

The FPM represents the actual velocity vector of the aircraft within the HUD TFOV. It is not horizontally fixed to the centerline of the TFOV. When the CDM and FPM symbols overlap, the CDM symbol has display priority over the FPM.

When the FPM symbol does not indicate the actual velocity vector (e.g., during the EGI alignment state, or when it reaches the display boundaries) an X is displayed in the center of the FPM.

HEADING SCALE AND INDICATOR

The Heading Scale presents $\pm 15^\circ$ (30° total) in magnetic azimuth off aircraft heading. Every 10° within this range is annotated by a tic mark with two digits above it, representing hundreds and tens of degrees respectively. Every 5° is marked by a shorter tic mark without digits, Figure 1-135.

The Heading Indicator consists of a tic mark when the velocity type selected for display on the HUD is MAC or TAS. When GS is greater than 50 KTS and GS is selected for the Velocity Scale, magnetic ground track is displayed on the Heading Scale and the Indicator is changed from a tic mark (|) to a triangle symbol (Δ).

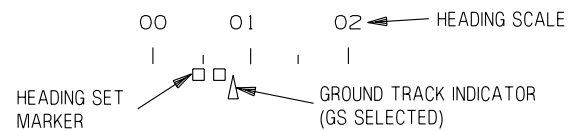

T38002-529-1-020

Figure 1-135. MIL-STD HUD Heading Scale and Indicator

The Heading Scale and Indicator appear in the upper portion of the HUD in all master modes.

HEADING SET MARKER

The heading set marker, Figure 1-135, indicates the heading that is manually set via the UFCP SET Key Display or MFD HDG rocker switch. The display consists of two small adjacent squares. If the set heading is out of the display scale limits, the Heading Set Marker is removed.

HORIZON LINE

The horizon line is a solid line that extends the entire width of the TFOV with a gap in the center. It is occluded by the Airspeed and Altitude Scales. The Ghost Horizon Line (Figure 1-136) is a dashed line that is displayed whenever the horizon line is out of the field of view. Its position indicates the direction of and orientation of the true horizon.

INSTANTANEOUS VERTICAL VELOCITY (IVV) DIGITAL READOUT

The Digital Readout of the IVV is displayed below the Altitude Dial. The display resolution is to the nearest 50 feet per minute with no leading zeroes. The letter V precedes the readout together with (+) for climb or (-) for dive.

INSTANTANEOUS VERTICAL VELOCITY (IVV) ARC

The IVV Arc is displayed with gear up whenever the CDM is HUD limited. It continues to be displayed for 30 seconds after the CDM comes out of HUD limiting. The IVV Arc Display utilizes the same scale as when the gear is down. Refer to MIL-STD HUD GEAR DOWN SYMBOLS this section.

T.O. 1T-38C-1
HUD

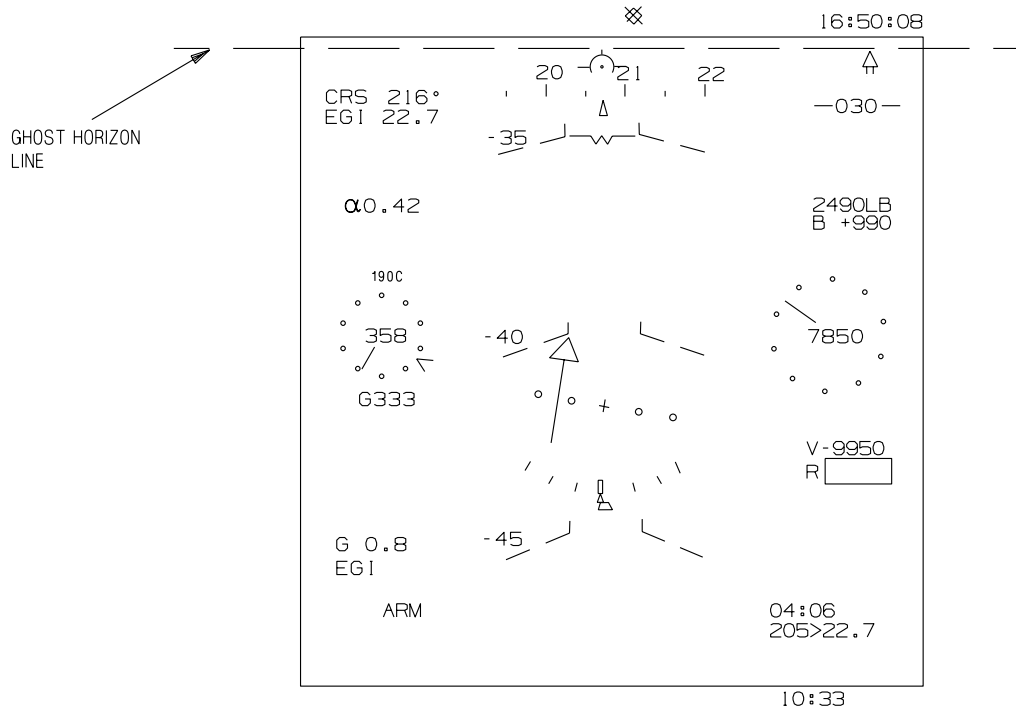

Figure 1-136. Ghost Horizon Line MIL-STD HUD

T38002-530-1-020

MESSAGE WINDOW

WCA Messages are displayed in this window. The window is located in the lower half of the HUD when the landing gear is up.

ZENITH/NADIR SYMBOLS

The center of the Zenith (a star shaped symbol) is displayed at the 90° climb point and the Nadir (a fielding circle) is displayed at the 90° dive point. The symbols represent the location of the 90° climb/dive point and appear when approaching 75°-85° of climb/dive. The arm of the Zenith and Nadir always points at a 90° angle to the nearest horizon. If the aircraft is rotating in either climb or dive, the Zenith and Nadir symbols rotate to keep the long point of the Zenith or Nadir pointing toward the nearest Horizon or Ghost Horizon Line, Figure 1-137.

PITCH LADDER

The Pitch Ladder is a set of roll stabilized lines, parallel to the horizon, that indicate pitch angles relative to the horizon within the HUD. The Pitch Ladder consists of climb/dive bars with numeric labels and a horizon line.

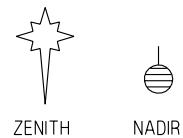

Figure 1-137. Zenith/NADIR Symbols

T38002-531-1-020

The Pitch Ladder displays the aircraft climb/dive angle when read relative to the CDM. The Pitch Ladder is displayed laterally to the CDM. The Ladder consists of solid climb bars and dashed dive bars. The climb/dive bars are positioned at 5° intervals from 0 to ±80°. The climb bars are straight and the dive bars are angled at 1/2 the pitch angle (e.g., 20° dive lines are angled at 10°). Solid lines represent positive values of climb with outer elbows pointing down towards the horizon and dashed lines represent dive angles with inner elbows pointing up towards the horizon. Numerals representing the value of climb/dive associated with each line are drawn beyond the edge of each line.

RADAR ALTIMETER (RALT) READOUT

The RALT readout displays current altitude above the terrain and is indicated by one to four digits (boxed) in increments of 10 feet, preceded by an R. The box is empty if the RALT information is not available because of the following reasons:

- a. No altitude received from the RALT due to a system malfunction.
- b. AGL altitude is greater than 5000 feet or the aircraft is banked more than 45°.
- c. The aircraft is on the ground with WOW.

d. RALT OFF (deselected via UFCP EGI Key Display or by selecting POD on MFD WPN Display Page).

SELECTED COURSE AND RANGE

The Selected Course and Range data is displayed in NAV master mode and shows the selected course and range to the selected PNS. The Selected Course is displayed by three digits with values ranging from 001° -360°. Range is displayed by up to four digits (no leading digits) with one digit after the decimal point (in the range 0.0-999.9). The source of the range data is described below:

PRIMARY NAVIGATION SOURCE	DIGITAL RANGE SOURCE	RANGE PREFIX DISPLAYED
TACAN	TACAN	TCN
VOR	VOR paired DME	VOR
EGI/SCA	EGI	EGI
ILS/LOC/BC with ILS selected in window 4 of UFCP NAVAID Sub-Menu Display	ILS paired DME	ILS
ILS/LOC/BC with TCN selected in window 4 of UFCP NAVAID Sub-Menu Display	TACAN	ILS

NOTE

- With TCN as the PNS and AAT selected, the digital range on the HUD is blank and the range prefix is TCN.
- In NAV backup with ILS as the PNS, the digital range source for the HUD is always the TACAN channel displayed on the TACAN Backup Control Panel. However, the digital range displayed next to the I in the range data block of the MFD Backup Display is always the ILS paired DME range.
- In NAV backup with TCN or ILS as the PNS, the digital range on the HUD is blank when the TACAN is in A/A mode.

This should only occur when the aircrew selects A/A on the TACAN Backup Control Panel.

The HUD Selected Course and Range data parallels the MFD displays for CRS and range.

TARGET DESIGNATOR (TD) BOX

The TD Box is displayed on the steerpoint at its coordinates and elevation in the NAV and A/G Master Modes.

T.O. 1T-38C-1 HUD

When the line of sight to the steerpoint is out of the display limits of the HUD, the symbol is displayed in the direction of the steerpoint with an X in its center.

NOTE

If no elevation exists for the steerpoint, the TD box is displayed on the horizon.

TIME OF DAY (TOD)

The TOD is constantly displayed in the upper right corner of the HUD in all Master Modes.

VERTICAL DEVIATION INDICATOR (VDI)

When ILS, LOC, or SCA is the PNS, the VDI is displayed to the left of the CDM, Figure 1-138. The VDI consists of a vertical scale and a dynamic pointer (<) to the right of the scale. Displacement of the VDI dynamic pointer above/below the HUD VDI Scale center depicts the relative aircraft position below/above the glideslope (e.g., Figure 1-138 depicts the aircraft above the glideslope).

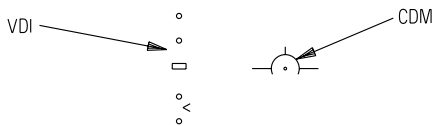

T38002-532-1-020

Figure 1-138. Vertical Deviation Indicator (VDI)

The VDI Scale has tic marks (corresponding to the MFD EADI VDI dots) such that one tic deflection represents the following glideslope deviations.

- For SCA - 0.35° .
- For ILS and LOC - Half beam deflection.

The VDI maximum displacement (two tic marks) represents the following glideslope deviations:

- For SCA - 0.7° or greater.
- For ILS and LOC - Full beam deflection or greater.

When ILS or LOC is selected as the PNS and the glideslope or localizer signal is not received, the dynamic pointer is removed from the display.

MASTER ARM SWITCH POSITION

The Master Arm Switch Position is displayed in the lower left portion of the HUD below the Avionics Master Mode/Submode in all Master Modes and indicates the Master Arm status (SAFE or ARM). Refer to T.O. 1T-38C-34- 1-1.

MIL-STD HUD GEAR DOWN SYMBOLS

The following HUD symbology, Figure 1-139 is displayed only with the landing gear down.

NOTE

In the event of RCP nose gear indication circuitry failure to the MDP; the STALL warning is not available (refer to Warning/Caution/Advisory (WCA) System, this section), gear down symbology on the HUD is not displayed (Refer to F-16 HUD Gear Down Symbols, this section and MIL-STD HUD Gear Down Symbols, this section), and the MDP automatic speed calculation is disabled.

2.5° DESCENT REFERENCE LINE

A 2.5° Descent Reference Line is added to the pitch ladder display, Figure 1-139.

COMMANDED AIRSPEED INDICATOR (SPEED BUG)

The manual Speed Bug Caret is replaced with the auto Speed Bug Caret and the TOT Commanded Speed, if selected, is deselected. The TOT commanded speed is not available. For additional display criteria, refer to UFCP FUNCTION KEYS, this section.

TARGET DESIGNATOR (TD) BOX

The TD Box is only displayed in NAV or A/G Master Modes when the steerpoint is DEST 500 - 509.

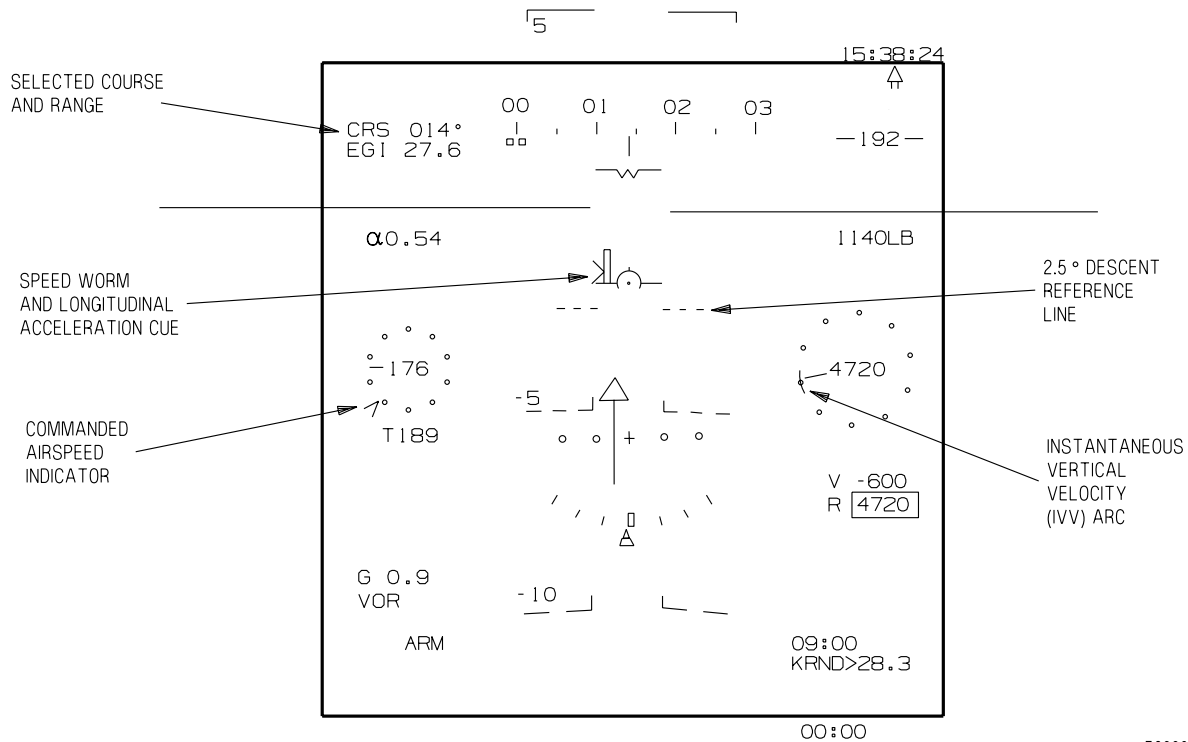
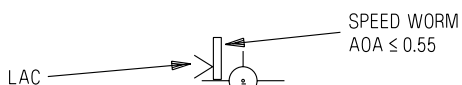

Figure 1-139. MIL-STD HUD Gear Down Symboly

T38002-533-1-020

LONGITUDINAL ACCELERATION CUE (LAC)

The LAC is located to the left of the CDM and is represented by a caret, which indicates the aircraft longitudinal acceleration when read against the CDM, Figure 1-140. The symbol moves above the CDM when the aircraft accelerates and below the CDM when the aircraft decelerates. The range of longitudinal acceleration represented is from approximately -5 knots/sec (deceleration) to approximately +5 knots/sec (acceleration). When longitudinal acceleration is zero, the caret is positioned even with the center of the CDM (the left wing).



T38002-571-1-020

Figure 1-140. Longitudinal Acceleration Cue

SPEED WORM

The Speed Worm is located on the CDM left wing and indicates the deviation from the aircraft optimal approach AOA when read against the CDM. The Speed Worm display range is 0.65 AOA units (top) to 0.55 AOA Units (bottom). When the Speed Worm is on the CDM wing, it represents an AOA of 0.6 (Figure 1-141). For AOA values above 0.65 (Figure 1-142) and below 0.55 (Figure 1-140), the Speed Worm will be limited and remain fixed at it's maximum size (15 milliradians).

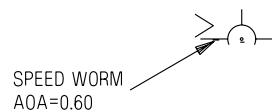

T38002-534-1-021

Figure 1-141. Speed Worm AOA=0.60

**T.O. 1T-38C-1
HUD**

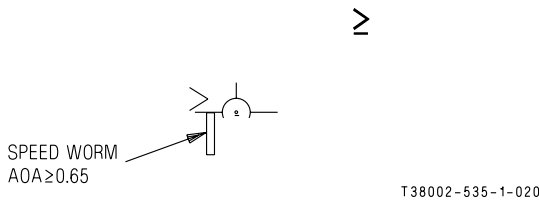

Figure 1-142. Speed Worm AOA >0.65

INSTANTANEOUS VERTICAL VELOCITY (IVV) ARC

The IVV Arc is a bold arc connecting altitude dial dots. The IVV Arc starts at the 9 o'clock position of the dial and extends in the clockwise direction when the aircraft is climbing and in the counter clockwise direction when the A/C is diving. Refer to Figures 1-143 and 1-144. The IVV Arc can indicate a climb/dive rate of up to 4000 fpm. For climb/descend rates greater than 4000 fpm, the IVV Arc remains limited at the 4000 fpm position. The IVV Arc is displayed

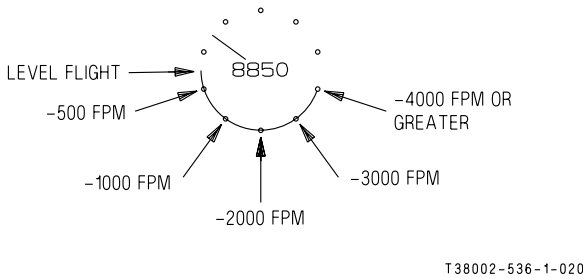

Figure 1-143. IVV ARC for Aircraft Descending

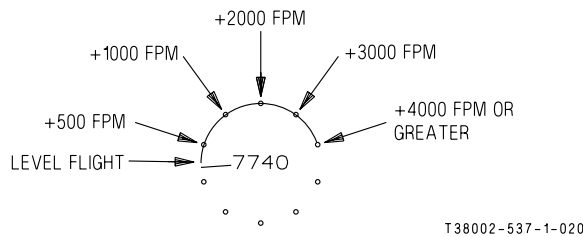

Figure 1-144. IVV ARC for Aircraft Climbing

when the landing gear is down or when the CDM is display limited.

MIL-STD HUD DECLUTTER

A declutter function is provided by the UFCP DCL Function Key. MIL-STD declutter items are the same as the F-16 HUD declutter items with the addition of a FPM.

The following items can be pre-selected, prior to flight, for removal from the HUD via mission planning software.

SYMBOL	MASTER MODE		
	NAV	A/A	A/G
Current G	X	X	X
Max G	X	X	X
Mach No	X	X	X
Total Fuel	X	X	X
Bingo Fuel	X	X	X
RALT	X	X	X
Altitude Alert	X	X	X
Safe/Arm Display	X		
TD Box	X		X
EGI Data Block			X
AOA		X	X
FPM (MIL-STD HUD Only)	X	X	X
Bullseye	X	X	X

Refer to UFCP FUNCTION KEYS, this section.

MULTIFUNCTIONAL DISPLAY (MFD)

MFD OVERVIEW

A single 8.3 X 6.2 inch colored Liquid Crystal Display (LCD) Multifunctional Display (MFD) is part of the head-down flight reference and provides aircrew integrated avionics control and display in each cockpit. The MFD is installed below the HUD in the FCP and in a comparable location in the RCP. Both MFDs are powered by the right essential 28 VDC bus. The MFD has two modes of operation: Normal and Backup.

Normal Mode

The MFD displays formats as generated and routed by the Mission Display Processor (MDP). During normal operation, aircrew may independently select and personalize their respective cockpit MFD display. Aircrew have an equal priority for selecting and controlling avionics functions and changing of parameters; the MDP always accepts the last command. For functions that control or change avionics modes or parameters, the appropriate display changes are applied to the relevant displays in both cockpits. A

repeater mode is also available which provides an identical display on both cockpit MFDs (RCP MFD repeats the FCP MFD display or FCP MFD repeats the RCP MFD display). The Take Command Switch in OVERRIDE reduces FCP avionics control capability, refer to TAKE COMMAND SWITCH, this section. See Figure FO-7 for menu display options and refer to T.O. 1T-38C-34-1-1 for all weapons delivery related information.

Backup Mode

In the absence of communication with the MDP, the MFD independently generates a basic PFR display using radio navigation and Embedded GPS/INS (EGI) data received from the appropriate sensors over dedicated ARINC-429 interfaces, refer to MFD BACKUP DISPLAY, this section.

MFD CONTROLS

The MFD buttons and switches, Figure 1-145, are

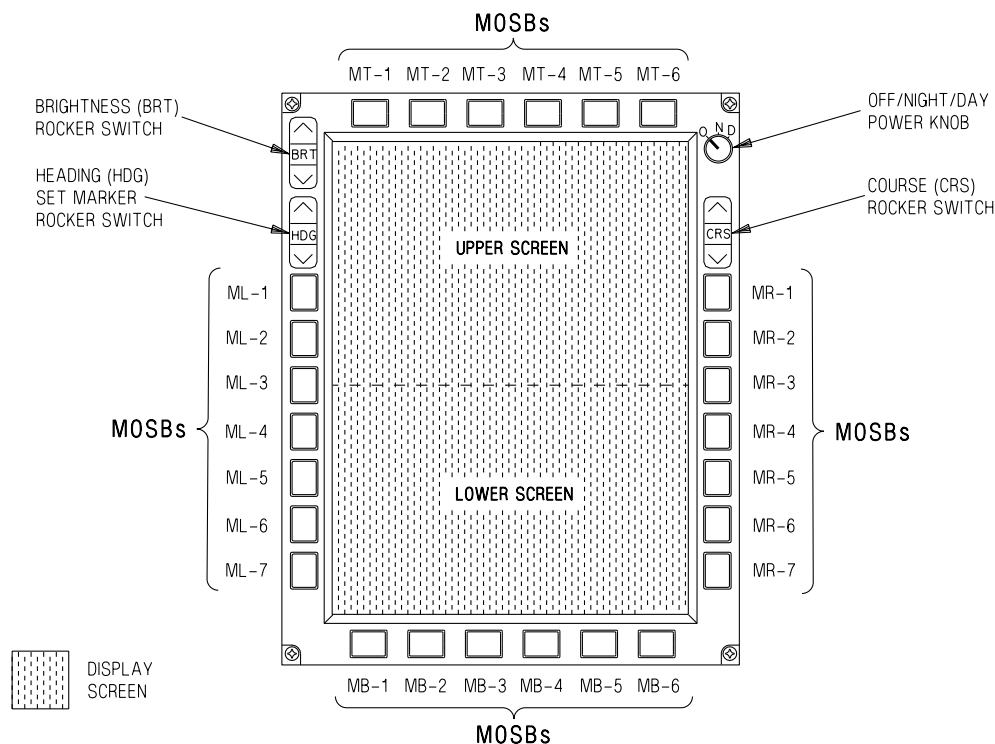

Figure 1-145. MFD Controls

T38002-225-1-020

T.O. 1T-38C-1

MFD

backlit with the brightness controlled via the aircraft lighting control panel INSTRUMENT Control Rheostat.

OFF/NIGHT/DAY (OND) POWER KNOB

The OND Power Knob is a 3-position rotary switch that controls power to the MFD and sets the basic default brightness of the display (night or day). The MDP powerup default display on the MFD is the Primary Flight Reference (PFR) display mode. The OND Power Knob selectable functions are defined as follows:

O (OFF)	MFD is OFF.
N (NIGHT)	The MFD is ON with night brightness range selected; display brightness can be changed via the Brightness Rocker Switch.
D (DAY)	The MFD is ON with day brightness range selected; display brightness can be changed via the Brightness Rocker Switch.

For ambient temperatures above 32°F, the MFD will turn on within 15 seconds. When the ambient temperature is below 32°F, the MFD may take up to 5 minutes to turn on. The MFD brightness may initially be dim during cold weather start-up.

When the MFD is powered up in the D position, the display brightness defaults to the maximum day mode brightness. If N is then selected and the existing display brightness is greater than the maximum night brightness, the display brightness will be set at the maximum night brightness. If the current day mode brightness setting is within the allowable night range, the brightness will remain at the current setting. The night mode brightness can be adjusted by using the Brightness Rocker Switch.

When the MFD is powered up in the N position, the display brightness defaults to the maximum night mode brightness. MFD maximum display brightness in the N position is approximately 10% of maximum day brightness. If D is then selected, the display brightness will remain in the existing night setting. The day mode brightness can then be adjusted by using the Brightness Rocker Switch.

BRIGHTNESS (BRT) ROCKER SWITCH

The BRT Rocker Switch controls the brightness level of both the symbols and the video input within the range selected by the position of the OND Switch (night or day). Pressing the top side (↑) increases the brightness, while pressing the bottom side (↓) decreases the brightness. Momentarily pressing either the top or bottom of the switch changes the brightness of all symbology by a single increment. Holding the switch pressed provides a logarithmic adjustment of the brightness of all symbology, enabling transition from minimum to maximum brightness or maximum to minimum in approximately 5 seconds.

HEADING (HDG) SET MARKER ROCKER SWITCH

The HDG Set Marker Rocker Switch controls the selected manual heading. Momentarily pressing the upper portion (↑) increases, or lower portion (↓) decreases the selected heading by 1°. Pressing and holding the switch changes the setting at either a 20°/second or 40°/second rate of change, depending on how long the switch is held. The selection moves the position of the Heading Set Marker (captain's bars) around the MFD EHSD/HSD Heading Scale, as well as on the MIL-STD and F-16 HUD Heading Scale. The selection works in parallel with the UFCP SET Key Display. When the switch is released, the heading displayed on the UFCP SET Key Display is updated to the new value. The MDP powerup default is the last value selected.

COURSE (CRS) ROCKER SWITCH

The CRS Rocker Switch controls the selected course/track and is displayed in the Course Select Window (CSW) of the MFD. Momentarily pressing the upper portion (↑) increases, or lower portion (↓) decreases the selected heading by 1°. Pressing and holding the switch changes the setting at either a 20°/second or 40°/second rate of change, depending on how long the switch is held. The CRS Rocker Switch works in parallel with the UFCP SET Key Display. When the CRS Rocker Switch is released, the selected course displayed on the UFCP SET Key Display is updated to the new value. The MDP powerup default is the last value selected.

MFD OPTION SELECT BUTTONS (MOSBs)

There are 26 MOSBs on the perimeter of the MFD, used for entry of data and selection of various options/functions within the selected displays and are

identified as follows:

Top Row	MT-1 thru MT-6 from left to right.
Bottom Row	MB-1 thru MB-6 from left to right.
Left Side	ML-1 thru ML-7 from top to bottom.
Right Side	MR-1 thru MR-7 from top to bottom.

When displayed on the MFD screen, relevant menu options are selected by pressing the adjacent MOSB. The options associated with the MOSBs change as applicable for each specific display. On most display formats, the title and function of two of the bottom row MOSBs stay the same to allow for immediate selection of that function:

MENU	MB-1 selects the MENU Display Page.
PFR	MB-3 selects the PFR Display Page except when the PFR is the active display.

The top row MOSB functions do not change for most display formats. These buttons are used in normal flight displays to select and control the PNS or steering mode (FD, EGI, VOR, TCN, ILS/LOC, BC/SCA).

For data entry, either alphabetic (ALFA) or numeric (NUM) characters are displayed next to the left and right MOSBs. Pressing the adjacent MOSBs enters letters or numbers as appropriate.

NOTE

During certain MFD failure modes (e.g., MFD HOT or display backlight failure), the MFD display can go blank but the MOSB's remain operational

MFD DISPLAYS

The MFD screen provides a color display of aircraft flight parameters and control function data, Figure 1-146. Except for the EED and HUD displays that use

the entire MFD Screen area, normal flight displays are divided into upper and lower screen displays, Figure 1-145.

NOTE

Vertical lines may be seen occasionally on the MFD. These lines are the result of horizontal sync circuitry instability and do not affect MFD usability.

Option titles are provided around the edge of the MFD screen that enable selection of other displays or functions. A title is displayed only when the associated option is available. When a display/function title is selected, it is normally highlighted with a box around it. The majority of titles are colored green except for:

a. The navigation source titles at the top of the MFD which are colored as follows:

TITLE	COLOR
EGI and SCA	Cyan
VOR	Magenta
ILS/LOC/BC	Yellow
TCN	Orange

b. The Master Mode (NAV, A/A, A/G) is colored yellow when the Master Arm Switch is armed (ARM).

c. The DCL 0 and DCL 2 are colored yellow when HSD Map Symbols are auto decluttered.

d. The MALF is colored yellow after a PFL is activated and has not been reviewed by aircrew.

There are three types of displays selectable for viewing flight parameters during normal operations:

- PFR Basic flight instruments (upper screen), other flight and navigation data and the EHSI (lower screen).
- HSD Basic flight instruments (upper screen), other flight and navigation data and a Horizontal Situation Display (lower screen).
- HUD Display of current HUD CTVS picture (full screen) on either MFD.

T.O. 1T-38C-1

MFD

The MFD can also be used to display aircraft systems, navigation, and weapons information on function pages selected from the MENU Display Page, refer to MFD MENU AND FUNCTION DISPLAY PAGES, this section.

Displays can be independently personalized in each cockpit or synchronized via a repeater function. Options are available in each cockpit to allow blanking of all or part of the other cockpit's display.

PFR (MB-3) is displayed in all formats, except when in the PFR Display, where MB-3 is labeled HSD.

MENU (MB-1) is displayed in all formats, except when in the EED Display Page, where the menu function is available at MB-1 but the title MENU is not displayed.

There are certain elements common to multiple displays:

- a. Basic flight instruments including the primary control and performance flight parameters.
- b. Flight Data Blocks providing supplemental flight parameters.
- c. NAV and COMM Data providing current and programmed navigational and communications information.

In all MFD formats other than HUD and EED (which require a full screen), the MFD upper screen is basically unchanged. When MENU or function pages are selected, the AOA Indicator and G Meter are removed, the remaining flight instruments are retained in the upper screen of the MFD and the selected function data is displayed in the lower screen of the MFD. Aircraft heading is displayed on all MFD pages except for the EED Display Page.

PFR DISPLAY - TACAN SELECTED AS PNS

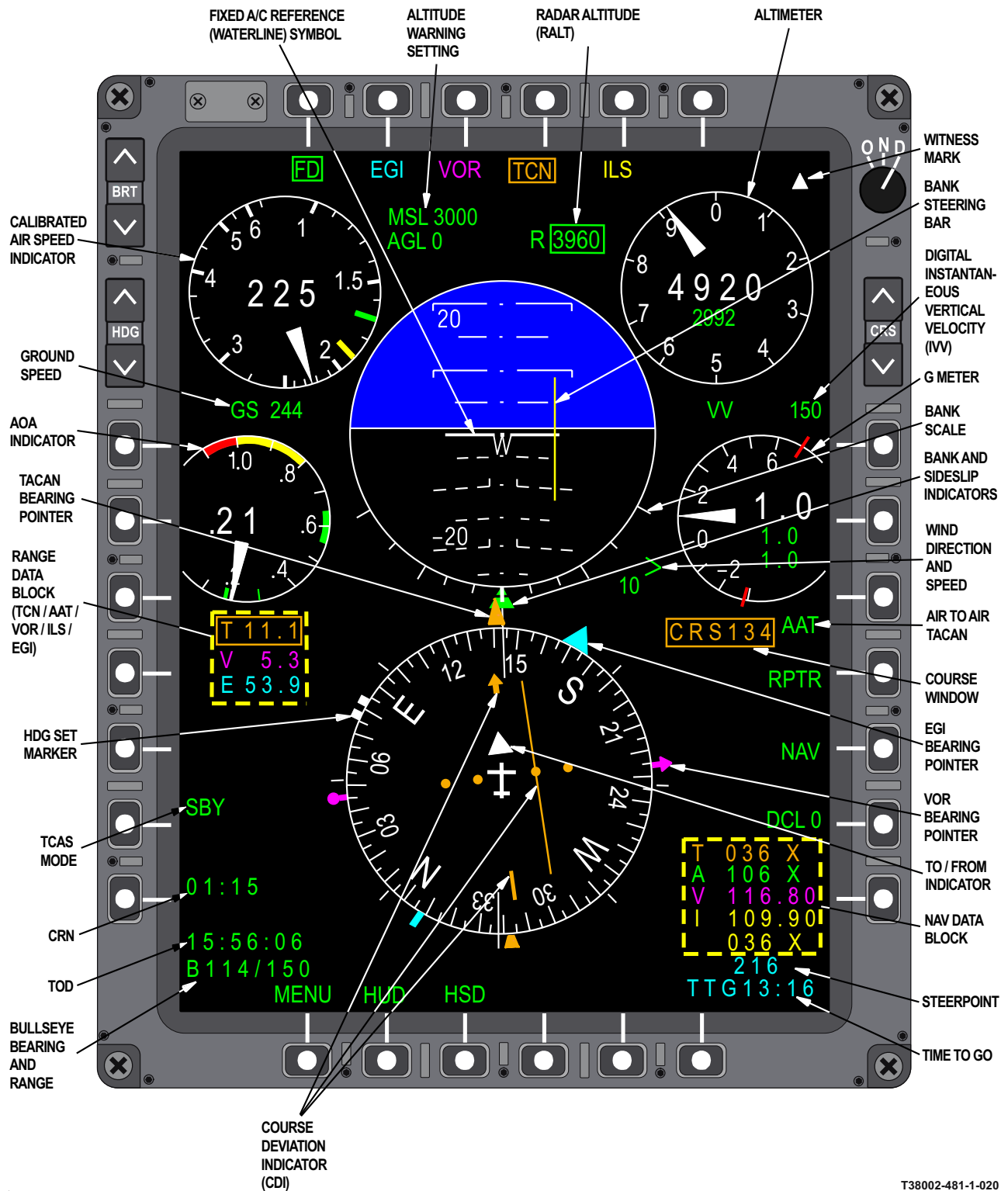

Figure 1-146. Multifunctional Display (MFD) (Sheet 1 of 3)

T38002-481-1-020

PFR DISPLAY-ILS SELECTED AS PNS



Figure 1-146. Multifunctional Display (MFD) (Sheet 2)

T38002-481-2-021



Figure 1-146. Multifunctional Display (MFD) (Sheet 3)

T38002-481-3-021

BASIC FLIGHT INSTRUMENTS

ELECTRONIC ATTITUDE DIRECTION INDICATOR (EADI)

The EADI is comprised of the following components:

- a. Fixed Aircraft Reference (Waterline) Symbol.
- b. Sky (colored blue).
- c. Ground (colored black).
- d. Horizon Line, Ghost Horizon Line and Chevrons.
- e. Pitch Ladder, Zenith and Nadir.
- f. Bank and Slip Indicators.
- g. Vertical Deviation Indicator (VDI).
- h. FD Pitch Steering Bar (if selected).
- i. FD Bank Steering Bar (if selected).
- j. Climb/Dive Marker (CDM) Symbol (if selected).
- k. TCAS Exclusion Zones.

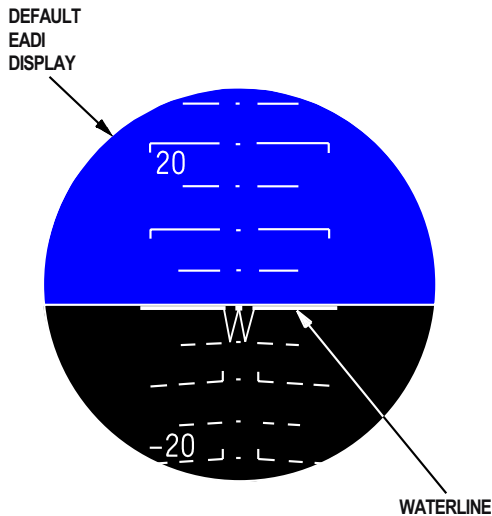

Figure 1-147. MFD EADI Waterline Symbol

Fixed Aircraft Reference (Waterline) Symbol

The Waterline Symbol represents the aircraft with an extended W, Figure 1-147. Double thickness horizontal extensions represent the wings of the aircraft on the EADI. A dot is displayed on the center peak of the extended W at the same vertical position as the symbols horizontal wings. The dot is fixed at the center of the EADI and the horizon lines and pitch ladder move behind it relative to aircraft motion.

Climb/Dive Marker (CDM) Symbol

When CDM is selected on the UFCP NAV Sub-Menu Display, the position of the CDM in relation to the Pitch Ladder displays aircraft climb/dive angle, Figure 1-148. When the aircraft is at level flight, the CDM is displayed coincident with the horizon line. The CDM is positioned along the vertical of the EADI so that it remains centered laterally within the EADI pitch ladder and moves in a plane perpendicular to the horizon. If the actual position is outside the EADI circle, the CDM is replaced by a dashed CDM which is displayed along the EADI boundary.

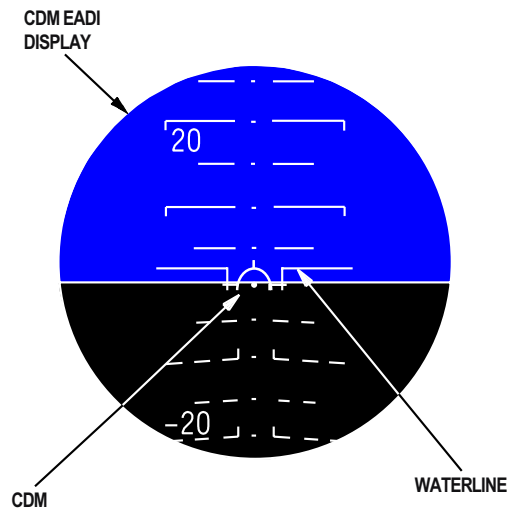

Figure 1-148. MFD EADI CDM Symbol

With CDM selected, the Waterline consists of single thickness wings with downward pointing inboard elbows and a dot fixed at the center of the EADI. The position of the Waterline dot in relation to the Pitch Ladder displays aircraft pitch attitude.

Horizon Line, Pitch Ladder, Zenith, and Nadir

The horizon line, pitch ladder, zenith, and nadir symbols resemble the MIL-STD HUD. The EADI covers 50° of pitch. These symbols are displayed and defined as follows:

- a. Horizon Line: When the aircraft is at zero pitch (e.g., aircraft on level ground) the horizon line is displayed on the Waterline with CDM selected, or 3° above the Waterline Symbol with CDM deselected. During rolling maneuvers, the center of rotation of

the pitch ladder and horizon line is the center dot of the Waterline symbol. When the pitch angle exceeds $\pm 22^\circ$, a Ghost Horizon Line and two red Chevrons (pointing to the horizon) are displayed on the EADI longitudinal center line, see Figure 1-149. The Ghost Horizon Line is a dashed line (colored white) displayed at 3° from the appropriate edge of the EADI (top for a climb and bottom for a dive).

b. Pitch Ladder: The pitch ladder consists of climb (solid)/dive (dashed) bars every 5° . Climb/dive bars at 10° increments are longer than the climb/dive bars at 5° increments. The 20° , 40° , 60° , and 80° climb/dive bars are labeled respectively, see Figures 1-147 and 1-148. The climb (solid) bars are parallel to the horizon. The dive (dashed) bars are angled at $\frac{1}{2}$ the pitch angle.

c. Zenith: The Zenith indicates straight up (positive 90° pitch) and resembles an elongated star, Figure 1-149. The long point of the star always points to the nearest horizon. If the aircraft is rotating, the Zenith symbol rotates to keep the long point of the star always pointing to the nearest horizon or Ghost Horizon Line.

d. Nadir: The Nadir indicates straight down (negative 90° pitch), Figure 1-149. The arm of the Nadir always points to the nearest horizon. If the aircraft is rotating, the Nadir symbol rotates to keep the arm of the Nadir always pointing to the nearest horizon or Ghost Horizon Line.

Bank and Slip Indicators

The EADI Bank Indicator (triangle) reads against the fixed Bank Scale displayed on the lower boundaries of the EADI, Figure 1-146 (Sheet 1 of 3). The triangle moves around the Bank Scale so that its position relative to the tic marks indicates the bank angle of the aircraft (i.e., aircraft banks left, triangle moves left). The Bank Scale consists of a center tic mark and five tic marks on either side of center, representing 10° , 20° , 30° , 45° and 60° of aircraft roll. When bank angle is greater than 55° , additional tic marks are displayed at 90° and 135° on the same side of the scale as the Bank Indicator.

The EADI Slip Indicator (trapezoid) is displayed below the Bank Indicator. The trapezoid displacement from the triangle indicates the magnitude and direction of the aircraft sideslip when read against the Bank Scale (sideslip indicator directionality is the same as other aircraft). As an example, with a bank angle of 30° and a side slip of 3° the triangle would be displayed at 30° and the trapezoid would be displayed at 33° . When the side slip is zero, the upper portion of the trapezoid matches the bottom portion of the Bank Indicator display triangle.

EADI IN VERTICAL DIVE

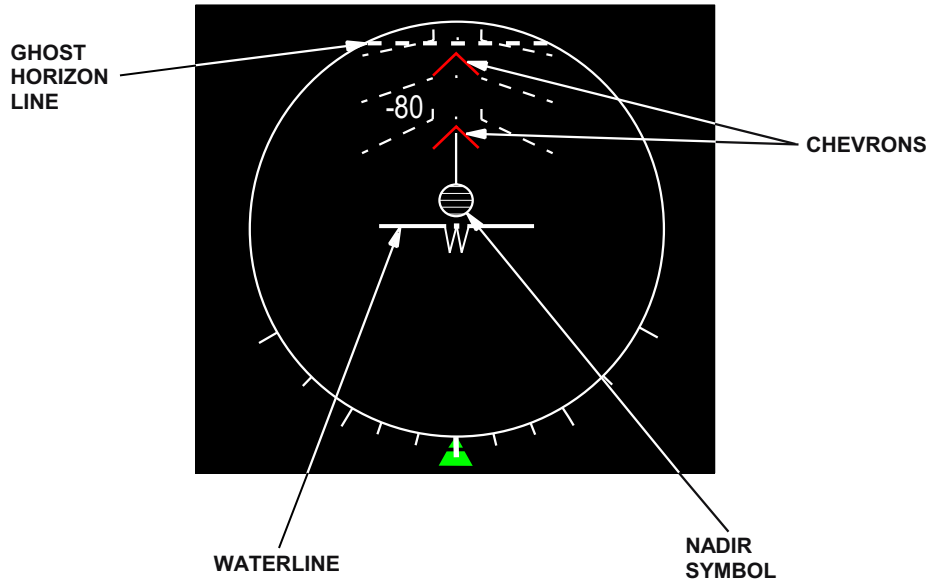

EADI IN VERTICAL CLIMB

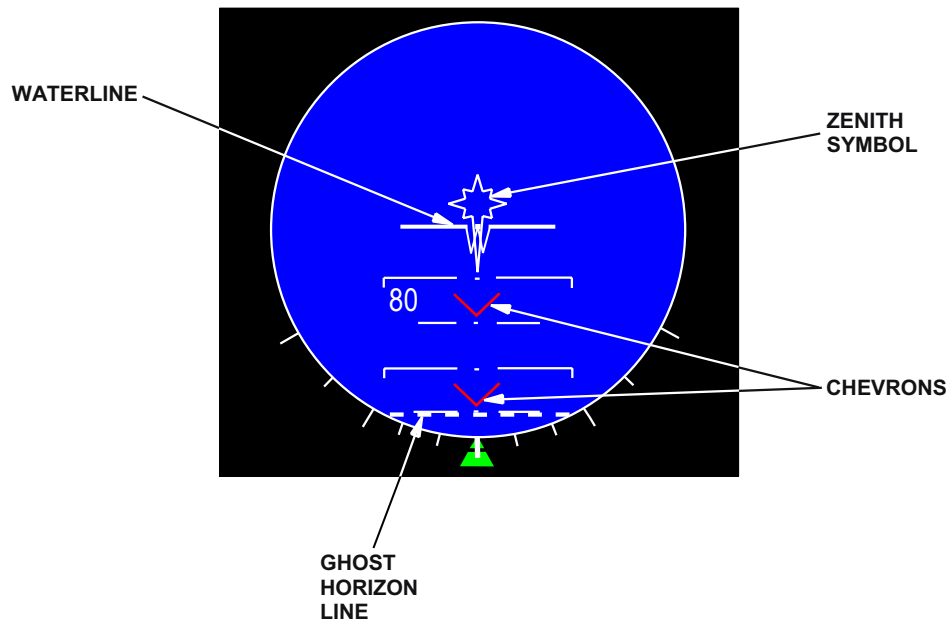

Figure 1-149. MFD EADI

Vertical Deviation Indicator (VDI)

The EADI VDI is the glideslope raw data symbol, Figure 1-146 (Sheet 2). This symbol is displayed on the EADI when ILS, LOC or SCA is selected as the PNS. The VDI consists of a fixed scale (located next to the 9 o'clock position of the EADI Display) and a dynamic pointer (solid white triangle located on the right) representing the glideslope position relative to the aircraft. Displacement of the triangle above/below the VDI Scale center depicts the relative aircraft position below/above the glideslope (e.g, Figure 1-146, Sheet 2, depicts the aircraft above the glideslope).

The VDI Scale, one dot deflection, represents the following glideslope deviations:

- a. For SCA - 0.35°.
- b. For ILS and LOC - Half beam deflection.

The VDI maximum displacement (two dots) represents the following glideslope deviations:

- a. For SCA - 0.7° or greater.
- b. For ILS and LOC - Full beam deflection or greater.

When ILS or LOC is selected as the PNS and the glideslope or localizer signal is not received, the triangle is removed from the display. VDI is not displayed when BC is the PNS.

Flight Director (FD) Bank Steering Bar

The FD Bank Steering Bar is a vertical yellow bar that is displayed when EGI, VOR, TCN, ILS, LOC, BC or SCA is the PNS with FD active and valid data is provided by the selected navigation source, Figure 1-146 (Sheet 2).

The Bank Steering Bar moves left and right relative to the Waterline/CDM symbol. The left/right position relative to the waterline/CDM symbol indicates

the bank direction (if bar is left, left bank required, and vice versa). The distance from the waterline/CDM symbol is proportional to the required change in bank angle. The Bank Steering Bar is centered when the commanded bank is established.

Refer to FLIGHT DIRECTOR LOGIC AND USAGE, this section.

Flight Director (FD) Pitch Steering Bar

The FD Pitch Steering Bar is a horizontal yellow bar that is displayed when ILS or SCA FNL is the PNS with FD active and valid data is provided by the selected navigation source, Figure 1-146 (Sheet 2).

The Pitch Steering Bar moves up and down relative to the Waterline/CDM Symbol. The up/down position relative to the Waterline/CDM Symbol indicates the pitch direction (if bar is up, nose-up pitch required, and vice versa). The distance from the Waterline/CDM Symbol is the required amount of change in pitch angle (climb/dive angle). The Pitch Steering Bar is centered when the commanded pitch is established.

Refer to FLIGHT DIRECTOR LOGIC AND USAGE, this section.

TCAS Exclusion Zones

Refer to IDENTIFICATION, FRIEND OR FOE (IFF)/TRAFFIC COLLISION AVOIDANCE SYSTEM (TCAS), this section.

CALIBRATED AIRSPEED INDICATOR

The Calibrated Airspeed Indicator, Figure 1-150, is located in the upper left corner of the MFD, Figure 1-146, and has a non-linear scale on the perimeter with numbers representing hundreds of knots. The tic mark representing 240 KCAS is yellow, while the rest of the scale is white.

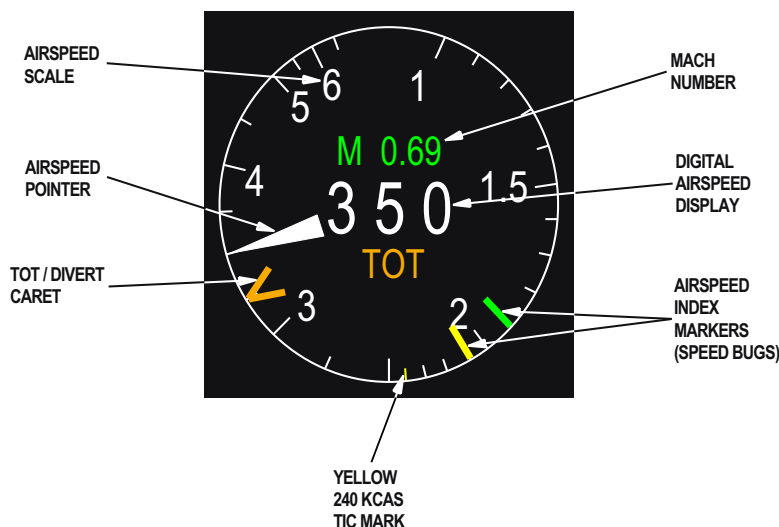

T38002-563-1-020

Figure 1-150. Calibrated Airspeed Indicator

The Airspeed Pointer rotates around the perimeter of the display and functions in parallel with a Digital Airspeed Display (up to 3 digit display in 1 knot increments) presented in the center of the display. The Airspeed Pointer and Digital Airspeed Display are both colored white. When airspeed data is not available, digital speed data is not displayed and the Airspeed Pointer indicates zero.

NOTE

When aircraft speed is below 12 KCAS, the digital readout displays 12 KCAS.

Digital MACH Number is displayed in green above the Digital Airspeed Display when MACH number is 0.40 or greater.

There are two adjustable Airspeed Index Markers (Speed Bugs, one colored green and one colored yellow). The MDP powerup default of both markers is last selected. The Speed Bugs are displayed in all Master Modes and set via the UFCP SET Key Display. Refer to UFCP FUNCTION KEYS, this section.

The orange TOT/Divert Caret on the Airspeed Indicator represents either the TOT commanded airspeed, or Divert Mode commanded airspeed. The caret is displayed when the commanded airspeed is

between 100 and 700 KCAS. Refer to GPS/INS BASED NAVIGATION, this section.

ALTIMETER

The Altimeter, Figure 1-151, is located in the upper right hand corner of the MFD, Figure 1-146, and has a linear scale on the perimeter with numbers 0 through 9, colored white, representing hundreds of feet.

The altitude pointer rotates around the perimeter of the display and has display priority over the numbers on the scale and altimeter setting. The Altitude Pointer functions in parallel with the Digital Altitude Display presented in the center of the Altimeter. The Altitude Pointer and Digital Altitude Display are both colored white and removed from display when not available.

Digital Altitude Display is presented within the following guidelines:

- a. If altitude is greater than or equal to 10,000, the two leading digits (thousands) are displayed full size with the remaining 3-digits (hundreds, tens, and units) displayed in a smaller font to the nearest hundred feet.
- b. If the altitude is less than 10,000 all digits are displayed full size to the nearest 10 feet.



T38002-565-1-021

Figure 1-151. Altimeter

The altimeter setting is presented below the Digital Altitude Display and is colored green. Altimeter settings are set via the UFCP ALT Key Display. The MDP powerup default is last value selected.

INSTANTANEOUS VERTICAL VELOCITY (IVV)

IVV is displayed both graphically and digitally on the MFD, Figure 1-146, and is defined and displayed as follows:

a. Graphically: An IVV Arc (colored green) is displayed around the Altimeter Display perimeter when the landing gear is extended. The IVV Arc operates at a rate of 0 ± 4000 fpm with zero indicated at the 9 o'clock position of the display. IVV Arc clockwise rotation indicates climb, and IVV Arc counterclockwise rotation indicates descent. The IVV Arc changes from green to red only during a descent greater than or equal to 4000 fpm. The IVV Arc changes back to green when the descent rate is less than 4000 fpm.

The IVV Arc is also displayed on the MFD Altimeter Display when the MIL-STD HUD CDM is display limited. The IVV Arc continues to be displayed for 30 seconds after the MIL-STD HUD CDM comes out of display limiting.



Figure 1-152. Altimeter with IVV

T38002-564-1-020

The green IVV Arc on the Altimeter, Figure 1-152 is scaled according to the following table:

CLIMB/DIVE RATE	IVV ARC POSITION ON THE ALTIMETER (CLIMB/DIVE)
Level Flight	750 ft (9 o'clock)
500 fpm	800/700 ft
1000 fpm	900/600 ft
2000 fpm	0/500 ft
3000 fpm	100/400 ft
4000 fpm	200/300 ft

b. Digitally: The IVV is displayed digitally (preceded by VV in green) below the altitude dial in the upper right hand corner of the MFD. Resolution of the IVV is 50 fpm (i.e. the last two digits of the display are either 00 or 50). The display is either 3-digits or 4-digits with the following guidelines:

- (1) When climb or dive is less than 1000 fpm, 3-digits are displayed, preceded by a (+) or (-).
- (2) When climb or dive is greater than or equal to 1000 fpm, 4-digits are displayed, preceded by either a (+) or (-).

- (3) The digital IVV readout below the altitude dial is restricted to ± 9950 fpm.

The Digital IVV Display changes from green to red during a descent greater than or equal to 4000 fpm.

The Digital IVV Display changes back to green if the descent rate is less than 4000 fpm.

ANGLE OF ATTACK (AOA) INDICATOR

The AOA Indicator, Figure 1-153, is located below the Calibrated Airspeed Indicator on the left side of the MFD, Figure 1-146. The scale represents AOA readings from 0.1 to 1.1 in 0.1 increments. The white numbers .2, .4, .6, .8 and 1.0 are displayed on the scale for reference.

Three different arcs are presented on the perimeter of the AOA display and are colored and defined as follows:

- a. A green arc is presented between 0.55 and 0.65 units AOA.
- b. The Approach to Stall Warning is a yellow arc displayed between 0.80 and 0.99 units AOA.
- c. The Stall Warning is a red arc displayed between 1.0 and 1.1 units AOA.

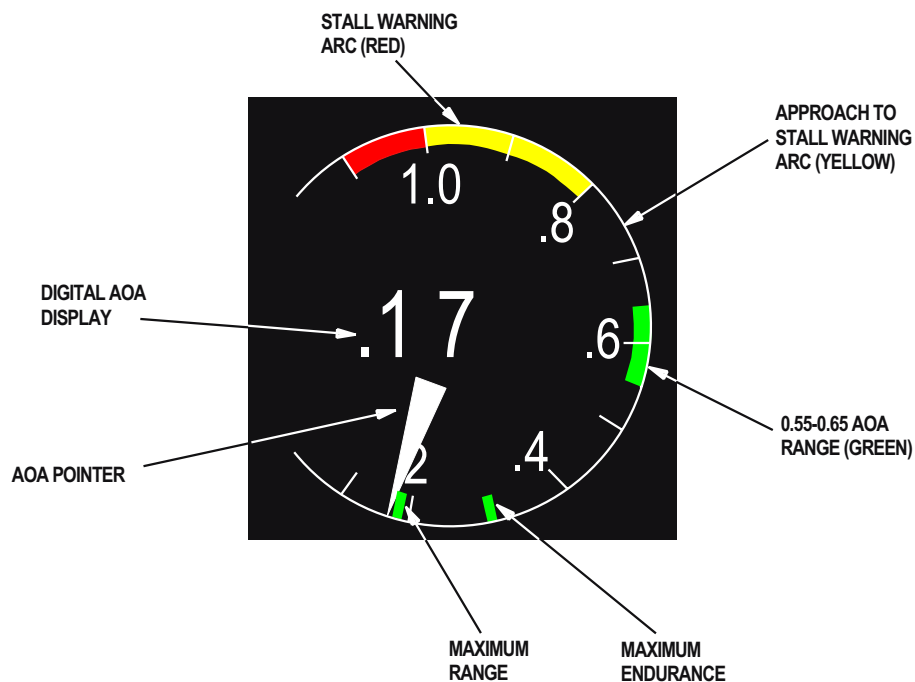

Figure 1-153. AOA Indicator

T38002-566-1-020

The approximate Maximum Range AOA and approximate Maximum Endurance AOA are represented by oversized green tic marks located at 0.18 and 0.3 respectively, on the AOA Indicator scale.

The AOA Pointer operates independently of altitude or gear position and is mechanized as follows:

- For the AOA range 0.0 - 0.79, the AOA Pointer is colored white.
- For the AOA range 0.80 - 0.99, the AOA Pointer is colored yellow.
- When AOA is 1.0 or greater, the AOA Pointer is colored red.

The AOA pointer rotates around the perimeter of the display and has display priority over the numbers and tic marks on the scale.

A three digit white Digital AOA Display is also presented in the center of the AOA Indicator.

G METER

The G Meter, Figure 1-154, is located below the Altimeter on the right side of the MFD, Figure 1-146, and has a white scale representing g load readings

from -3 to +7 in 1 g increments. The white numbers -2, 0, 2, 4, and 6 are displayed on the G Scale for reference.

The G Pointer and Current G Digital Display indicate current aircraft g calculated at the aircraft center-of-gravity. The Current G Digital Display is always white. The G Pointer can be colored white, yellow or red IAW Figure 1-155.

Max G Digital Display and Min G Digital Display are normally colored green, are presented below Current G Digital Display, and display the max/min g incurred since the previous G Meter reset. The Max/

Min G Digital Displays can be reset during flight if an over g condition has not occurred and are automatically reset following initial takeoff. See Figure 1-155 for display color changes in response to g limits.

Max G Limit and Min G Limit are represented by red oversized tic marks on the G Meter Display. The location of these red tic marks is calculated based on the aircraft fuel weight, configuration, and maneuver (symmetric / asymmetric). An asymmetric condition

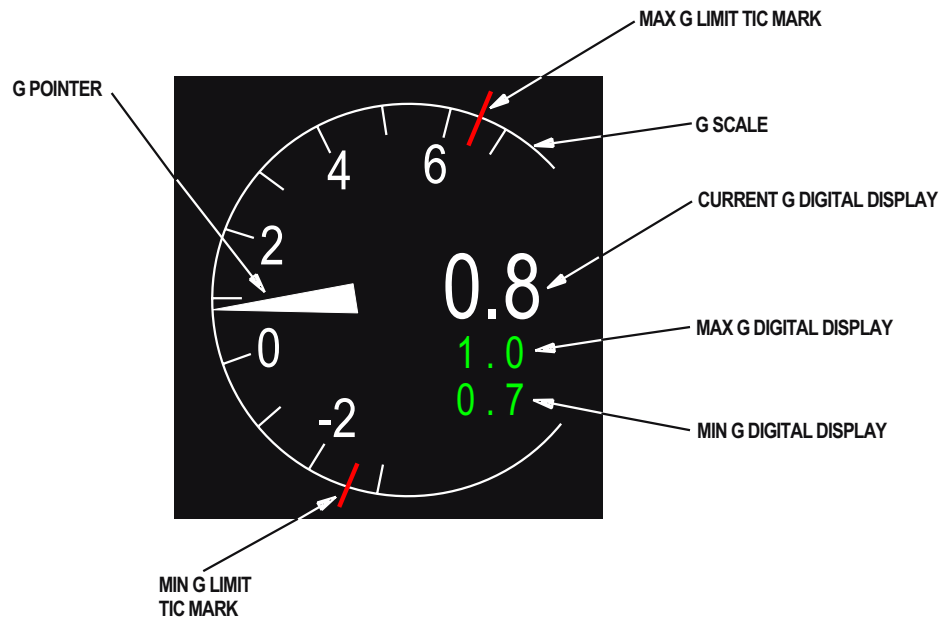

Figure 1-154. G Meter

T38002-567-1-020

is considered to exist when the roll rate is greater than $35^\circ/\text{sec}$ or roll acceleration is greater than $109^\circ/\text{sec}^2$. The more severe the asymmetric condition (greater roll rates and/or roll accelerations) the more the g limit is reduced. With POD selected on the WPN, the symmetric g limits are fixed at 0 and +4, refer to MFD MENU AND FUNCTION DISPLAY PAGES, this section.



G overshoots as a result of wingtip vortex or wake turbulence (jetwash) may not be of sufficient duration to trigger the MDP generated over g aural tone due to system processing rates. Pilots will use asymmetric g limits when evaluating a jetwash over g regardless of MDP g status.

Over g is defined as when the aircraft passes 100% of the max/min g limit. When an over g occurs, the G Pointer and appropriate Max/Min G Digital Display will latch red. The g limit tic mark (max or min) associated with the over g will be latched at the most severe over g (based on percent over g). OVER G is displayed in the HUD and MFD Message Windows and will remain displayed until acknowledged. A Max/Min G Digital Display and G Pointer latched condition can not be reset by aircrew. Refer to WARNING/CAUTION/ADVISORY (WCA) SYSTEM, this section.

G Meter behavior is described in Figure 1-155.

G's Remaining From Current Positive Or (Negative) G Limit						
		>1.0 (>0.5)	1.0 to 0.5 (0.5 to 0.25)	0.5 to 0.2 (0.25 to 0.1)	0.2 to 0.0 (0.1 to 0.0)	Over G (Limit Exceeded)
MFD G METER	G Pointer	White		Yellow until condition removed		Latches red, movement remains dynamic
	G RST (OSB)	Operative				OSB MR2 Inoperative
	Max/Min G	Green				Latches steady red
	G Limit Tic Marks	Red. Dynamic according to calculated g limit				Red. Latched on the most severe over G (based on percentage over-limit)
	Tone	- - - -	Medium pitch single rate beep	Medium pitch double rate beep	Medium pitch continuous tone for 3 seconds	Alternating low/med pitch tone for 3 seconds or until condition is removed (whichever is greater)
MFL Listing	No				Yes	
Over G Caution	No				Yes	

Figure 1-155. G Meter Behavior

NOTE

- An over g occurs when the aircraft exceeds the current maximum positive or negative g limit for greater than 0.1 second.
- When the aircraft passes the current maximum positive or negative g limit for less than 0.1 second the G Pointer turns red and an aural 3-second steady tone sounds. If aircraft g is reduced below maximum g limits within 0.1 second, an over g will not have occurred. In this case, the G Pointer does not latch red (MDP over g criteria not satisfied).

FLIGHT DATA BLOCKS

The PFR Display and HSD Display Flight Data Blocks consist of the following:

- Altitude Warning Setting.
- Radar Altitude.
- Ground Speed.
- Wind Direction and Speed.
- Chronometer (CRN).
- Time of Day (TOD).

a. If Altitude Warning Setting (MSL) is enabled, MSL is displayed and the number matches the baro active altitude warning selected by aircrew. There are no leading zeros.

b. If Altitude Warning Setting (AGL) is enabled, AGL is displayed and the number matches the AGL active altitude warning selected by aircrew. There are no leading zeros.

The Altitude Warning Setting is enabled via the UFCP ALT Key Display, refer to UFCP FUNCTION KEYS, this section.

ALTITUDE WARNING SETTING

The green Altitude Warning Setting display is presented to the right of the Calibrated Airspeed Indicator (above the EADI) on the MFD, Figure 1-146 and Figure 1-156. The display is described as follows:

RADAR ALTITUDE (RALT)

The green Radar Altitude display is presented above and to the right of the EADI, Figure 1-156. The Radar Altitude is boxed with up to 4-digits, preceded by an

T.O. 1T-38C-1

MFD

R. If RALT is not available, the R, the number, and the box are removed from the display.

GROUND SPEED

The green Ground Speed display is presented below the Calibrated Airspeed Display, Figure 1-156. The Ground Speed is displayed with up to 3-digits (to the nearest knot), preceded by GS. If Ground Speed data is not available, the numbers are removed from the display.

WIND DIRECTION AND SPEED

The green Wind Direction and Speed display is presented below the right side of the EADI, Figure 1-156. The wind direction pointer > rotates around the wind speed display (up to 3-digits) and points to the magnetic direction of the wind (e.g. for wind from the West, the pointer points to the East). Wind data source selection is as follows:

a. If aircraft bank angle is less than 18°, EGI is the source for wind data.

b. If aircraft bank is greater than 18°, an MDP wind table is the source for wind data. The MDP wind table contains wind data recorded during flight at various altitude increments.

CHRONOMETER (CRN)

The green CRN display is presented as MM:SS adjacent to ML-7 in the bottom left corner of the MFD, Figure 1-156.

TIME OF DAY (TOD)

The green TOD display is presented as HH:MM:SS below the CRN display in the bottom left corner of the MFD, Figure 1-156.

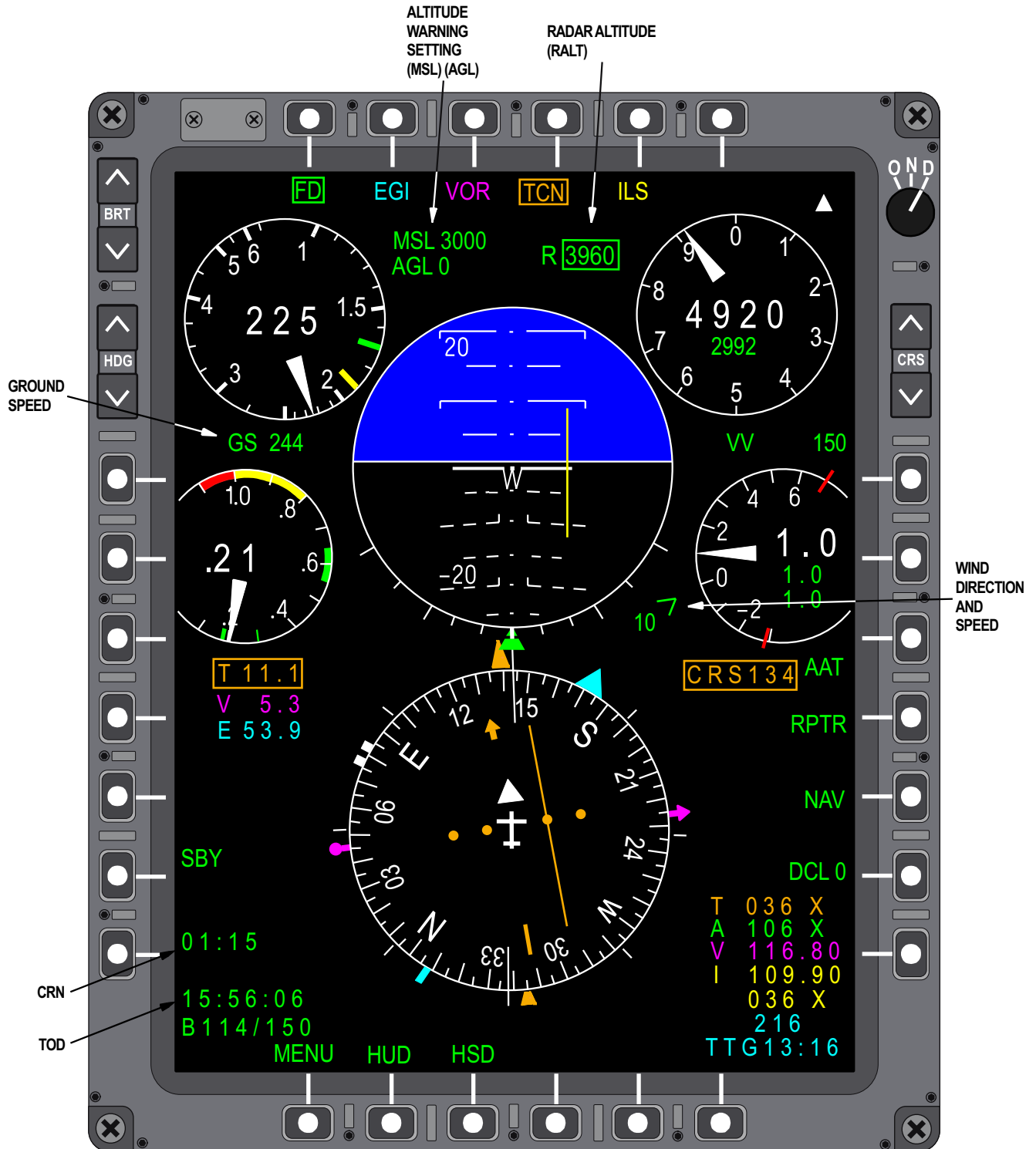

Figure 1-156. MFD Flight Data Blocks

T.O. 1T-38C-1

MFD

MFD NAV AND COMM DATA

The MFD NAV and COMM data on the PFR and HSD Displays consist of the following:

- a. Course Select Window.
- b. Range Data Block.
- c. NAV Data Block.
- d. Communication Data Block.
- e. Steerpoint.
- f. Time To Go.
- g. Bullseye Bearing and Range.
- h. Emergency Divert Mode Display

COURSE SELECT WINDOW

The Course Select Window (CSW) display is boxed and presented with CRS followed by the 3-digit selected course (001°-360°) with leading zeros, Figure 1-157, and is displayed to the right of the Wind Direction and Speed display and below the G Meter. The color of the CSW (box included) matches the PNS.

The CSW prefix CRS is replaced with APR when all the following occur:

- a. EGI is the PNS.
- b. Flying a flight plan and the current waypoint has APT as the steering type.
- c. Phase-of-Flight is Non-Precision Approach.

RANGE DATA BLOCK

The Range Data Block consists of three lines and is located below the AOA display, Figure 1-157. The order of display for the Range Data Block from top to bottom is TACAN (Line 1), VOR/ILS (Line 2), and EGI (Line 3). The PNS selection determines which of the lines is boxed. The range sources, their indicators, and colors are shown in the following table:

RANGE SOURCE	INDICATOR	COLOR
Air to Ground TACAN (TCN)	T	Orange
Air to Air TACAN (TCN)	A	Green
VOR DME	V	Magenta
ILS DME	I	Yellow
EGI	E	Cyan

If a secondary navigation source bearing arrow is deselected via the UFCP Bearing Arrow Sub-Menu Display, the associated range data line is removed from the Range Data Block. The Range Data Block indicators are always displayed and the range is only displayed with valid reception. When AAT is selected, VOR/ILS range display data is removed from Line 2 of the Range Data Block.

Range Data Block - Line 1

Line 1 is the TACAN range data for either Air-to-Ground (A/G) or Air-to-Air (A/A). The data displayed is defined and described as follows:

- a. Air to Ground TACAN is the default display.
- b. Air to Air TACAN is displayed when MR-3 is pressed (MR-3 toggles the AAT ON/OFF), selected via the UFCP NAV Source Sub-Menu Display, or selected via the TACAN Backup Control Panel.

Range Data Block - Line 2

Line 2 is the DME range data associated with either VOR or ILS. The data displayed is defined and described as follows:

- a. VOR DME is the default display.
- b. When ILS, LOC or BC is the PNS, either ILS paired DME or TACAN DME is displayed.

Range Data Block - Line 3

Line 3 is the EGI range to the steerpoint.

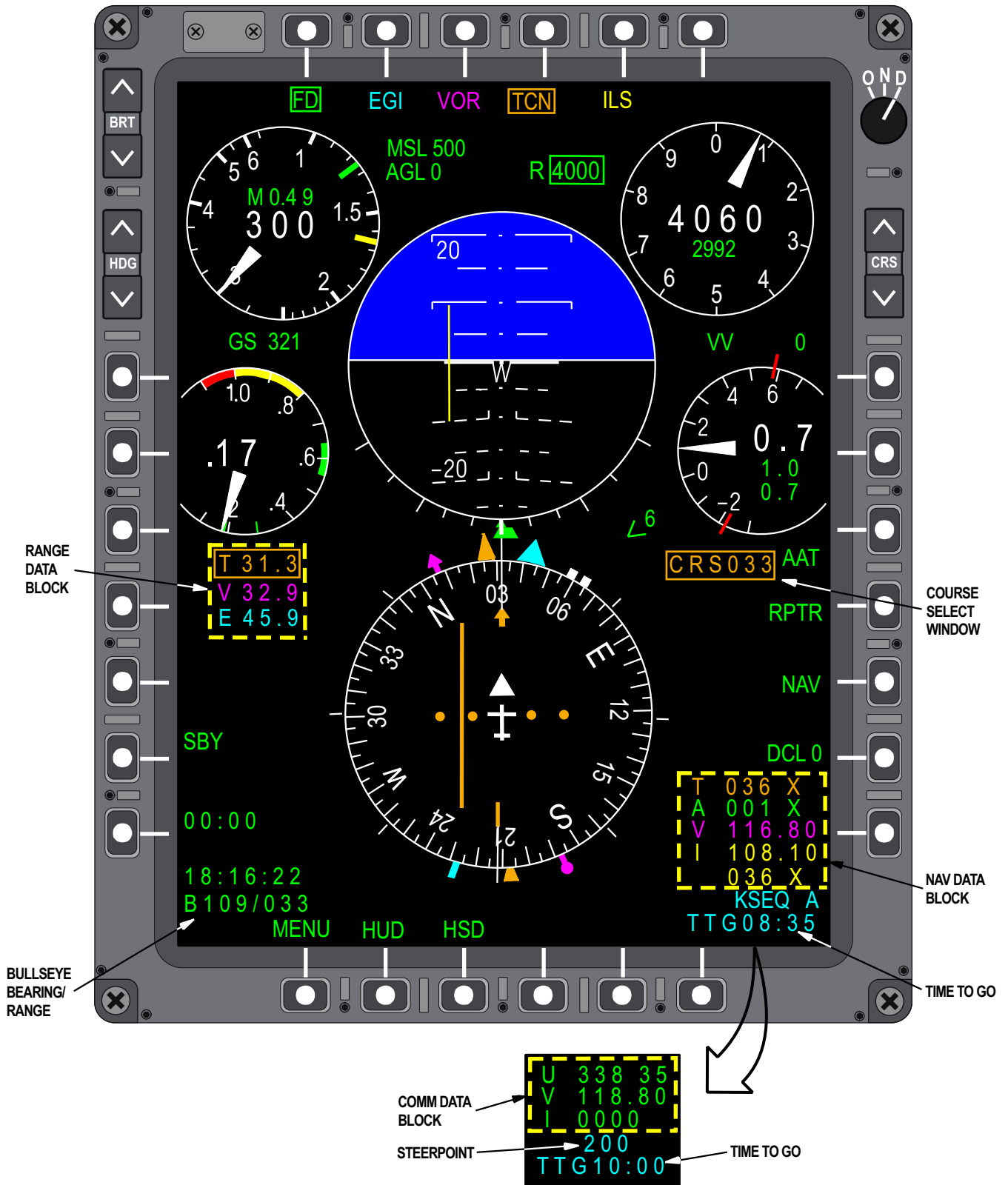

Figure 1-157. MFD NAV Data Blocks

T38002-483-1-021

T.O. 1T-38C-1

MFD

NAV DATA BLOCK

There are five lines in the MFD NAV Data Block, located on the bottom right side of the PFR Display and HSD Displays, Figure 1-158.



Figure 1-158. NAV Data Block

T38002-484-1-021

The NAV Data Block displays the current channel/frequency settings for TACAN (TCN and AAT), VOR, ILS, ILS DME (paired or TCN channel). Format and color are as shown in Figure 1-158. The data is presented as follows:

Line 1:	T XXX (X/Y) or EEEE	TCN Channel TCN ID (3-4 letters)
Line 2:	A XXX(X/Y)	AAT Channel
Line 3:	V XXX.XX	VOR Frequency
Line 4:	I XXX.XX	ILS Frequency
Line 5:	XXX (X/Y)	ILS Range Source (TCN Channel or paired DME)

Individual data lines display OFF when the associated source receiver is inoperative. During a fails-to-tune condition, the NAV Data Block displays the actual tuned channel/frequency and the opposing channel/frequency associated with that receiver (TCN/AAT, VOR/ILS) is removed. Refer to NAVIGATION TUNING, this section.

NAV Data Block - Line 1

Line 1 is the A/G TACAN channel/ID and displays a 3 to 4 letter Morse code identifier as long as the TACAN is receiving a valid ID which may take up to two minutes. The channel numbers are displayed when the receiver has no signal, is not receiving a valid ID, or is in Air-to-Air mode. In NAV Backup Mode or in a fails-to-tune condition, Line 1 is the channel reported from the TACAN when the TACAN is in A/G mode and is removed if in A/A mode.

NAV Data Block - Line 2

Line 2 is the channel reported from the TACAN when the TACAN is in A/A mode. When the TACAN is in A/G mode, line 2 is the channel that is tuned when A/A TACAN is selected, i.e. the AAT channel displayed on the UFCP NAVAID Sub-Menu. In NAV Backup Mode or in a fails-to-tune condition, Line 2 is the channel reported from the TACAN when the TACAN is in A/A mode and is removed if in A/G mode.

NAV Data Block - Line 3

Line 3 is the VOR frequency reported from the VOR/ILS receiver when ILS/LOC/BC is not the selected PNS. When ILS/LOC/BC is the selected PNS, line 3 is the VOR frequency that is tuned when VOR is selected, i.e. the VOR frequency displayed on the UFCP NAVAID Sub-Menu. In NAV Backup Mode or in a fails-to-tune condition, Line 3 is the frequency reported from the VOR/ILS receiver when the reported frequency is a VOR frequency and is removed when the reported frequency is an ILS frequency.

NAV Data Block - Line 4

Line 4 is the ILS frequency reported from the VOR/ILS receiver when ILS/LOC/BC is the selected PNS. When ILS/LOC/BC is not the selected PNS, line 4 is the ILS frequency that is tuned when ILS/LOC/BC is selected, i.e. the ILS frequency displayed on the UFCP NAVAID Sub-Menu. In NAV Backup Mode or in a fails-to-tune condition, Line 4 is the frequency reported from the VOR/ILS receiver when the reported frequency is an ILS frequency and is removed when the reported frequency is a VOR frequency.

NAV Data Block - Line 5

Line 5 is the ILS DME or TACAN channel displayed on the UFCP NAVAID Sub-Menu or paired ILS DME if operating in NAV Backup Mode. The line is colored Yellow regardless of ILS Range selection.

COMMUNICATION (COMM) DATA BLOCK

These three lines are located on the bottom right side of the PFR and HSD Displays above the Steerpoint Data Block, Figure 1-159. This block shows the current frequency setting for UHF radio, VHF radio, ATC transponder code. The COMM Data Block shares

the same display area with the NAV Data Block. MOSB MR-7 toggles between the two blocks of data.



T38002-485-1-020

Figure 1-159. COMM Data Block

The COMM data is presented as follows:

- Line 1: U XXX.XX UHF
Frequency or GRD
UHF Frequency
- Line 2: V XXX.XX VHF
Frequency or GRD
VHF Frequency
- Line 3: I XXXX ATC
Transponder
Code

Lines 1, 2, and 3 display the actual tuned frequency that the radio is reporting. OFF is displayed in Lines 1, 2, and 3 if the source radio is inoperative. When UHF backup is selected, OFF is displayed in line 1.

Line - 1

Line 1 shows the currently tuned UHF frequency as set on the UFCP Basic Menu Display window 3.

Line - 2

Line 2 shows the currently tuned VHF frequency as set on the UFCP Basic Menu Display window 4.

Line - 3

Line 3 shows the currently tuned ATC Transponder code as set on the UFCP IFF/TCAS Key Display.

STEERPOINT

The cyan Steerpoint contains the EGI steerpoint displayed on the UFCP Basic Menu Display. It is displayed in the lower right corner of the PFR and HSD Displays, Figure 1-157. Valid display formats are:

- a. Destination point - DDD indicates three digit destination number.

- b. ICAO point - II G to IIII G indicates the two to five character ICAO name plus the group letter (N, W, or A for navaid, waypoint or airport).

- c. Flight plan - F-WW, steerpoint with no ID. F is the flight plan number 0 thru 9 and WW is the waypoint number with leading zero.

- d. Flight plan - PP to PPPP, steerpoint with ID. Indicates the two to five character name of a waypoint.

TIME TO GO (TTG)

The cyan TTG data to the steerpoint is displayed in the lower right corner of the PFR and HSD Displays, Figure 1-157.

BULLSEYE BEARING AND RANGE

The green Bullseye Bearing and Range Display, Figure 1-157, is displayed in the lower left corner below the TOD of the MFD. Bullseye Bearing and Range information is from bullseye to ownship aircraft. The bearing and range format is BXXX/XXX. Bearing is displayed as 001-360 and range as 000-999. If selected on the UFCP, the Bullseye Bearing and Range are displayed in all master modes. If Divert Mode is selected, the Emergency Divert Mode Display is presented in the lower left corner of the MFD in place of the Bullseye Bearing and Range information.

EMERGENCY DIVERT MODE

The Emergency Divert Mode, Figure 1-160, provides the aircrew with critical information in one of the three profiles:

- a. Divert (DVT) - default display upon activation.
- b. Range (RNG).
- c. Endurance (ENDR).

The selected profile is displayed in the bottom left corner (replaces CRN, TOD, and Bullseye Bearing and Range Data) of the PFR Display after activation via the UFCP TOT Sub-Menu Display, refer to UFCP FUNCTION KEYS, this section.

On both the PFR and HSD Displays, pressing MOSB ML-7 cycles between the DVT, RNG, and ENDR profile pages. Refer to GPS/INS BASED NAVIGATION, this section.

UFCP TOT SUB-MENU

EMERGENCY DIVERT MODE ACTIVATED

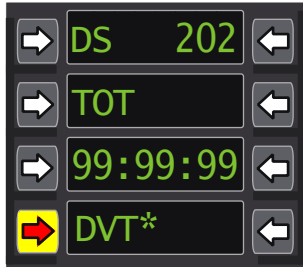

PFR DISPLAY

EMERGENCY DIVERT MODE



NOTE

CHANGING THE DS POINT IN WINDOW 1R OF THE UFCP TOT SUB-MENU DISPLAY DOES NOT CHANGE THE EGI DEST POINT USED FOR CALCULATIONS IN THE EMERGENCY DIVERT MODE.

EMERGENCY DIVERT MODE ACTIVATED

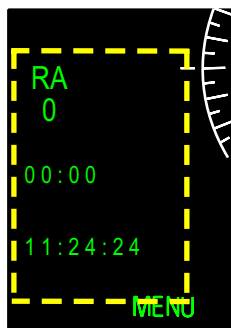

DIVERT MODE NOT ACTIVATED

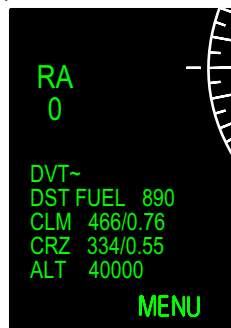

DIVERT (DVT) MODE DISPLAY

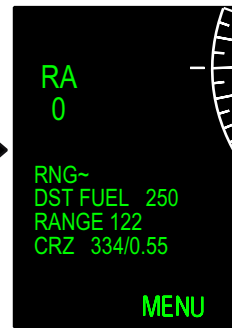

RANGE (RNG) MODE DISPLAY

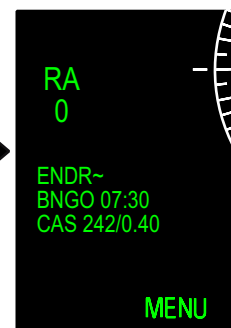

ENDURANCE (ENDR) MODE DISPLAY

Figure 1-160. Emergency Divert Mode Displays

T38002-486-1-021

PRIMARY FLIGHT REFERENCE (PFR)

PFR is the primary MFD display page used for navigation. This display is selected by pressing the adjacent MOSB for PFR on the MFD, pressing the DDS on the Stick Grip, or as the default upon entry into the navigation master mode. The display contains all the displays as described in BASIC FLIGHT INSTRUMENTS, this section, and data blocks as described in FLIGHT DATA BLOCKS and MFD NAV AND COMM DATA, this section. In addition, the PFR display contains the Electronic Horizontal Situation Indicator (EHSI).

ELECTRONIC HORIZONTAL SITUATION INDICATOR (EHSI)

The EHSI displays the following on the bottom half of the PFR (Figure 1-161):

- a. 3-inch diameter, 360° compass rose.
- b. VOR/TACAN/EGI bearing pointer with tails.
- c. Heading set marker.
- d. CDI and the TO/FROM indicator.

e. Aircraft Symbol

VOR Bearing Pointer

The magenta VOR Bearing Pointer symbol indicates the bearing to the selected VOR station. It is functional in all avionics modes, whenever VOR reception is available. If VOR is not selected on the UFCP Bearing Arrow Sub-Menu Display, and VOR is not the PNS, the Bearing Arrow is not displayed. Refer to UFCP CONTROLS AND DISPLAYS, this section.

TACAN Bearing Pointer

The orange TACAN Bearing Pointer symbol indicates the bearing to the selected TACAN station. It is functional whenever TACAN reception is available. If TCN is not selected on the UFCP Bearing Arrow Sub-Menu Display, and TCN is not the PNS, the Bearing Arrow is not displayed. Refer to UFCP CONTROLS AND DISPLAYS, this section.

EGI Bearing Pointer

The cyan EGI Bearing Pointer symbol indicates the great-circle bearing with no wind correction to the

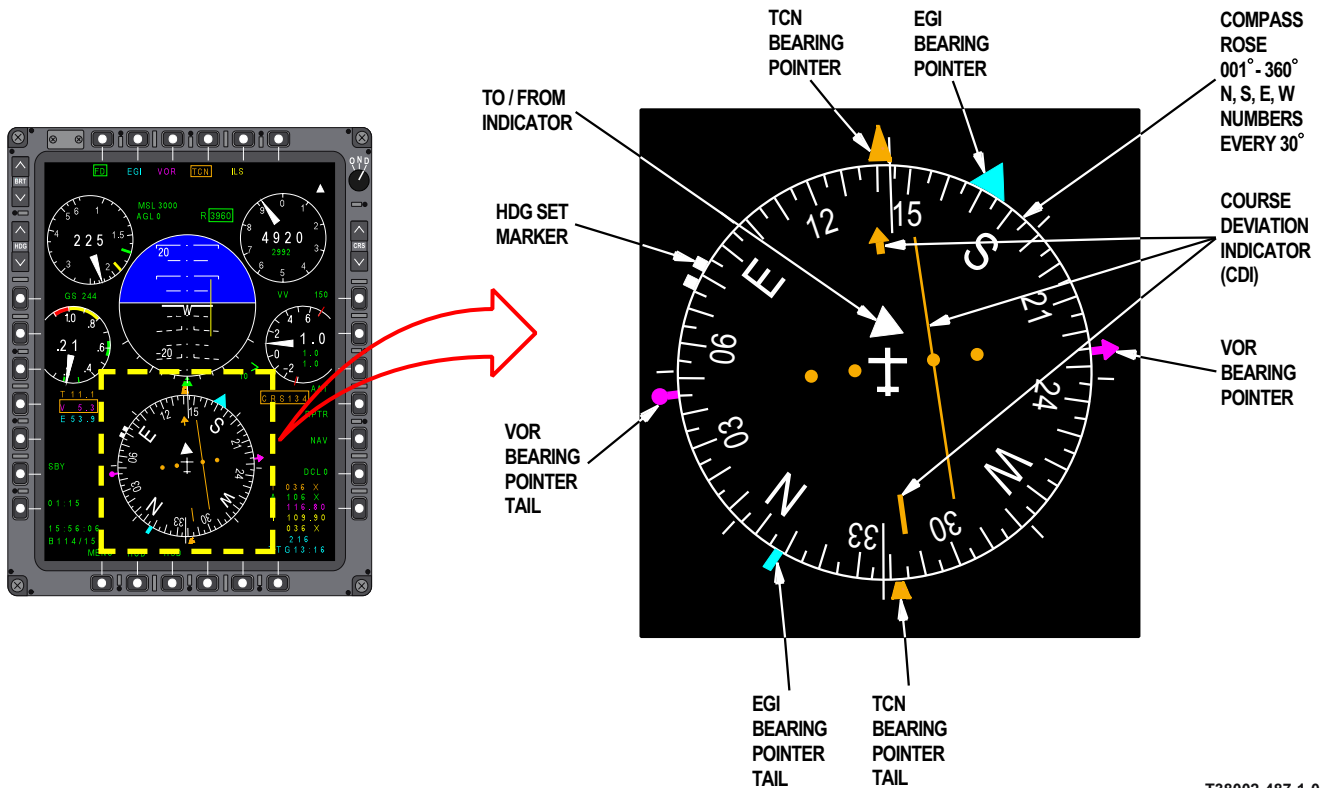

Figure 1-161. Primary Flight Reference and EHSI Displays

T38002-487-1-020

steerpoint. It is functional in all avionics modes whenever valid bearing data is being received from the EGI regardless of the PNS selection. When there is no bearing data (during some stages of the EGI alignment process), the symbol is not displayed. If EGI is not selected on the UFCP Bearing Arrow Sub-Menu Display, and EGI is not the PNS, the Bearing Arrow is not displayed. Refer to UFCP CONTROLS AND DISPLAYS, this section.

Heading Set Marker

The white Heading Set Marker symbol is always displayed in all avionics modes, at the heading selected via the MFD HDG Set Marker Rocker Switch or the UFCP Set Key Display. Refer to MFD CONTROLS or UFCP CONTROLS AND DISPLAYS, this section.

Course Deviation Indicator (CDI) Display

The display contains four parts:

- a. Course Arrow (head and tail).
- b. Course Deviation Indicator.
- c. Four-dot Deviation Scale.

- d. To/From Arrow.

The CDI is displayed when course deviation commands are valid. It is removed when the PNS is VOR, TCN, ILS, LOC, or BC and the selected mode's signal is not received. When EGI is the PNS, the CDI is removed when data is not available. When TCN is the PNS, the CDI is removed when AAT is selected due to the loss of bearing data.

The Course Arrow and the Four-dot Deviation Scale are always displayed. The Course Arrow and dots provide the following information:

- a. The Course Arrow rotates around the aircraft symbol representing the angle between the aircraft heading and the selected course.
- b. The Four-dot Deviation Scale rotates around the aircraft symbol with the Course Arrow always perpendicular to the dots.
- c. Deviation from the selected course is represented by the CDI in relation to the dots. Each dot represents course deviation in the following mode:
 - (1) VOR, TACAN or EGI - 5°.
 - (2) SCA - 1.25°.

T.O. 1T-38C-1

MFD

- (3) ILS, LOC or BC - The first dot represents half scale deflection and the second dot represents full scale deflection.

The maximum deflection in any PNS is 2.4 dots.

The TO/FROM indicator is displayed around the Aircraft Symbol, and always points to the head or tail of the Course Arrow. If the selected course leads to the station/waypoint, the symbol points to the head of the Course Arrow (TO). If the selected course leads from the station/waypoint, the symbol points to the tail of the Course Arrow (FROM).

Four different sources can drive the CDI: TACAN, EGI, VOR, and ILS/LOC.

- a. TACAN source CDI - Active when TACAN is the selected PNS (MT-4 boxed).
- b. EGI source CDI - Active when EGI is the selected PNS (MT-2 boxed), or when SCA (MT-6) is active.
- c. VOR source CDI - Active when VOR is selected as PNS (MT-3 boxed).
- d. ILS/LOC source CDI - Active when ILS or LOC is the selected PNS (MT-5 boxed), or BC (MT-6) boxed.

PFR OPTION SELECT BUTTONS (OSB) LABELS AND FUNCTIONS

MOSBs on the MFD, Figure 1-162 enable the aircrew to control the options and data settings presented on various MFD displays. The most important displays (including the HUD on the MFD) can be selected directly via the MOSBs on the PFR Display. In addition, the Stick Grip DDS resets any current format to the default display of PFR or HSD.

MT-1 - FD

Pressing MT-1 toggles the FD ON/OFF on the HUD and both MFDs; it functions in parallel with the UFCP NAV Sub-Menu Display. The FD functional displays are mechanized as follows:

- a. When selected (ON), the FD title is boxed and the Bank Steering Bar is displayed on the EADI providing steering commands to the Selected Course on the MFD. A corresponding asterisk (*) is presented on the UFCP NAV Sub-Menu Display.
- b. Pressing MT-1 again, deactivates the FD mode, unboxes the FD title, removes the asterisk from the UFCP NAV Sub-Menu Display, and removes the Pitch and Bank Steering Bars from the EADI display.

The FD defaults to ON or OFF upon PNS selection according to the following logic:

- a. OFF - If EGI, VOR, or TCN is selected.
- b. ON - If ILS, LOC, BC, or SCA is selected.

Refer to FLIGHT DIRECTOR LOGIC AND USAGE, this section.

MT-2 - EGI

Pressing MT-2 selects EGI as the PNS. The EGI title is boxed and EGI becomes the CDI command source for the EHSI.

MT-3 - VOR

Pressing MT-3 selects VOR as the PNS. The VOR title is boxed and VOR becomes the CDI command source for the EHSI.

MT-4 - TCN

Pressing MT-4 selects TACAN as the PNS. The TCN title is boxed and TACAN becomes the CDI command source for the EHSI.

MT-5 - ILS or LOC

Pressing MT-5 the first time selects ILS as the PNS. The ILS title is boxed and ILS becomes the CDI command source for the EHSI.

Pressing MT-5 a second time, replaces the ILS title with LOC, and selects LOC as the PNS. When LOC is active, a BC title is displayed below MT-6 (replacing SCA if displayed). The LOC title is boxed and LOC becomes the CDI command source for the EHSI.

Subsequent presses of MT-5 toggles between ILS and LOC.

MT-6 - BC or SCA

The MT-6 title display is normally blank/inactive unless LOC is the PNS or SCA is active. The display and function of this MOSB is as follows:

- a. If LOC is the PNS, pressing MT-6 selects BC as the PNS. The BC title is boxed and BC becomes the CDI command source for the EHSI. BC is unboxed when any other PNS is selected.
- b. If SCA is active, pressing MT-6 selects SCA as the PNS. The SCA title is boxed and SCA becomes the CDI command source for the EHSI. SCA is activated via the UFCP NAV Sub-Menu, refer to UFCP CONTROLS AND DISPLAYS, this section.

MOSB LABELS AND FUNCTIONS



Figure 1-162. PFR Display

T38002-488-1-021

T.O. 1T-38C-1

MFD

ML-1 / ML -2 / ML-3

ML-1, ML-2, and ML-3 are non-functional and have blank display titles (AOA Display area).

ML-4 / ML-5 - (Display Scale Control)

Pressing ML-4 (increase) or ML-5 (decrease) manipulates the display scale selection for PFR (2.5, 5, 10, 20) or HSD (15, 30, 60, 120). The PFR display scale is only presented in Traffic Advisory (TA) or Resolution Advisory (RA) mode; the display scale is always presented on the HSD display. Refer to IDENTIFICATION, FRIEND OR FOE (IFF)/TRAFFIC COLLISION AVOIDANCE SYSTEM (TCAS), this section.

A display scale decrement function is also available via the HOTAS MMS. Refer to HANDS ON THROTTLE AND STICK (HOTAS), this section.

ML-6 - 0, 1, or 2 (TCAS Declutter)

This option is only displayed when the TCAS is in TA or RA mode. Pressing ML-6 cycles and selects the TCAS declutter level (0, 1, or 2). Refer to TCAS, this section.

NOTE

- Declutter levels are unrelated to current TCAS mode.
- Declutter selection is eliminated when TCAS is in C, STBY, or A modes, or when TCAS is off.

TCAS mode is always displayed. When the TCAS mode is changed, the newly commanded mode flashes green until the TCAS enters that mode. If the TCAS fails to enter the commanded mode after 15 seconds, the mode display stops flashing, reverts back to the actual mode reported by TCAS, and is displayed in yellow to indicate that the TCAS is operating in a mode other than the commanded mode.

ML-7 - (Chronometer Hack/Divert Mode Profiles)

Pressing ML-7 for the first time hacks the chronometer (if not already activated). Successive actuations cycle between stop, reset/start. If divert mode is active, ML-7 cycles through the three profiles; DVT, RNG and ENDR.

MR-1

MR-1 is not used and has a blank title.

MR-2 - (G Meter Min/Max reset)

Pressing MR-2 resets the maximum positive/negative G readout on the G Meter Display on the MFD and F-16 HUD Display to the current G value.

MR-3 - AIR-TO-AIR TACAN (AAT)

Pressing MR-3 the first time selects the Air-to-Air TACAN (AAT) mode; successive actuations toggle AAT OFF/ON. When activated, the AAT title is boxed and AAT becomes the range data source displayed in Line 1 of the Range Data Block; the TACAN bearing pointer and CDI are removed from the EHSI, and VOR range data is removed from Line 2 of the Range Data Block.

MR-4 - REPEATER (RPTR)

Pressing MR-4 the first time (in either cockpit) allows the synchronization of both (FCP and RCP) MFD displays; the cockpit that initiated the RPTR request receives the other cockpit's display and the RPTR title is boxed on both MFDs. Successive actuations toggle RPTR OFF/ON. Until the RPTR option is terminated, the FCP and RCP MFD displays are identical and display commands affect both MFDs. The UFCP R Hot Key can also be used to toggle the RPTR OFF/ON. Refer to HOT KEYS, this section.

NOTE

Both aircrew can personalize their MFD displays independently; the default MFD repeater option is OFF. RPTR mode may cause aircrew confusion for functions that control or change avionics modes or parameters.

MR-5 - NAV, A/A, or A/G (Master Mode Selection)

Pressing MR-5 cycles the master mode (NAV, A/A, or A/G) and is only available on the PFR and HSD displays; the title (NAV, A/A, or A/G) corresponds to the master mode selected and functions in parallel with the MMS. The color of the title indicates the setting of the Master Arm Switch as follows:

- a. Master Arm - ARM: The title color is Yellow.

- b. Master Arm - SAFE: The title color is Green.

MR-6 - DECLUTTER (DCL) 0/1/2

Pressing MR-6 selects the PFR and HSD declutter levels previously programmed in the MPC. Successive actuation toggles between DCL 0, DCL 1, and DCL 2.

- a. DCL 0 (Default) - all symbology is displayed.
- b. DCL 1 - removes HSD Map Symbols from the HSD display and does not affect the PFR.
- c. DCL 2 - removes the symbols selected for declutter via the MPC (which may or may not include HSD Map Symbols). The declutter items selected cannot be altered in the aircraft.

Declutter is independent of the selected master mode and only affects PFR and HSD displays. Toggling between PFR and HSD does not affect the declutter state. Selection of a new master mode sets the declutter state to DCL 0. Changing the PNS does not affect the declutter state. Declutter is independently selectable between FCP and RCP.

Symbols selectable in the MPC for MFD declutter are:

- a. Altitude Warning.
- b. RADAR Altitude.
- c. Ground Speed.
- d. Wind Data.
- e. TOD.
- f. NAV Data Block (includes TACAN and AAT channels, VOR frequency, ILS frequency, ILS DME or TACAN channels).
- g. COMM Data Block (includes UHF, VHF and ATC transponder code frequencies).
- h. EGI steerpoint.
- i. TTG.
- j. Bullseye Bearing and Range and Bullseye symbol.
- k. HSD Map Symbols.

NOTE

NAV Data Block, COMM Data Block, and HSD Map Symbols are selectable for Declutter only when mission planning data is provided from JMPS.

MR-7 - (NAV/COMM Data Block Display Select)

Pressing MR-7 toggles between the NAV Data Block and the COMM Data Block.

MB-1 - MENU

Pressing MB-1 selects the Menu Display Page.

MB-2 - HUD REPEATER (HUD)

Pressing MB-2 selects the HUD Repeater Display Page.

MB-3 - PFR or HSD

Pressing MB-3 toggles between PFR and HSD Displays. The titled display (unboxed) is the un-selected display. On all MFD display pages except the PFR, MB-3 is titled PFR and selects the PFR. On the PFR page, MB-3 is titled HSD and selects the Horizontal Situation Display.

MB-4

MB-4 is not used on PFR or HSD display formats.

MB-5 - MALFUNCTIONS (MALF)

The title is blanked with MB-5 inoperative unless an unviewed PFL item exists. When a PFL item occurs, the yellow MALF title is displayed and MB-5 becomes operative. Pressing MB-5 activates the PFL display. After a PFL is viewed and the previous display is recalled or if the cause of the PFL is eliminated, the MALF title is blanked and MB-5 becomes inoperative until another unviewed PFL occurs.

NOTE

- The MALF title appears at the same time the AVIONICS Advisory appears on the MFD and HUD. The Advisory can be cleared from the MFD/HUD by pressing the UFCP ACK Key, but the MALF title remains in view until cleared by PFL viewing or PFL cause elimination.
- The PFL list can be viewed via the PFL Display Page. Refer to MENU DISPLAY OPTIONS, this section.

MB-6

MB-6 is not used.

T.O. 1T-38C-1

MFD

HORIZONTAL SITUATION DISPLAY (HSD)

The HSD is selected by pressing MB-3 on the PFR Display Page, Figure 1-163. The MDP superimposes collected data (navigation) with programmed data (loaded via the DTS and/or UFCP) to provide the pilot with an updated, dynamic view of the tactical environment in a top (over-head) view display format. The HSD display is presented in the lower screen of the MFD in place of the EHSDI (as seen in the PFR display); data outside the current range scale is not displayed. All of the other PFR displays remain unchanged. HSD is the default display when A/A or A/G master modes are entered from another mode via MOSB or HOTAS.

Range Scale

The Range Scale, Figure 1-163, consists of one circle (inner) and two semi-circles (middle and outer) centered around the Aircraft Symbol on the HSD. The inner and middle circles are colored Green while the outer circle is colored White with the Heading Scale superimposed. The circle's radii are 1/3, 2/3, and full scale of the selected range. Full scale is defined as the range from the Aircraft Symbol to the outer ring scale.

The selected Range Scale is displayed on the HSD adjacent to ML-4 / ML-5 in 15, 30, 60, and 120 NM increments and set via ML-4 (increase) and ML-5 (decrease). The default scale is 30 NM at powerup. An HSD Range Scale decrement function is also available via the HOTAS MMS. Refer to HANDS ON THROTTLE AND STICK (HOTAS), this section.

Heading Scale

The white Heading Scale, Figure 1-163, is located on the upper side of the outer range scale arc and displays 50° to each side from the center of the scale ($\pm 50^\circ$ of current aircraft heading). The arc of the Heading Scale also serves as the outer range circle of the range scale. White perpendicular tic marks are presented every 10° on the scale with numbers displayed every 30° (030°, 060°, 090°, etc.).

The Heading Window, presented above the center of the outer range scale, displays the aircraft magnetic heading.

On the inner side of the inner range scale, the letters N, S, E, and W are presented every 90° to represent magnetic North, South, East, and West, respectively.

The aircraft heading reference line connects the center of the heading window with the center of the heading scale.

Aircraft Symbol

The white Aircraft Symbol, Figure 1-163, is presented at the center of the inner range scale circle. The vertical line of the Aircraft Symbol represents the fuselage and always points to the heading window at the top of the HSD display.

The center point of the Aircraft Symbol represents the location of the ownship on the HSD.

HEADING (HDG) Set Marker Symbol

The white HDG Set Marker Symbol, Figure 1-163, is displayed on the outer side of the heading scale and represents the manual heading selection; commonly referred to as Captain's Bars.

EGI Bearing Pointer Symbols

The cyan EGI Bearing Pointer Symbols, Figure 1-163, represent the great-circle bearing to the EGI steer-point and are displayed on the inner side of both the outer (heading scale) range and inner range scales. When the bearing is greater than 90° to either side, the symbol on the outer range scale is removed; the symbol on the inner range scale indicates the correct bearing at any angle.

VOR Bearing Pointer Symbols

The magenta VOR Bearing Pointer Symbols, Figure 1-163, represent the magnetic bearing to the selected VOR station whenever VOR reception is valid. The symbols are displayed on the inner side of both the outer (heading scale) range and inner range scales. When the bearing is greater than 90° to either side, the VOR Bearing Pointer Symbol on the outer range scale is removed; the VOR Bearing Pointer Symbol on the inner range scale indicates the correct bearing at any angle.

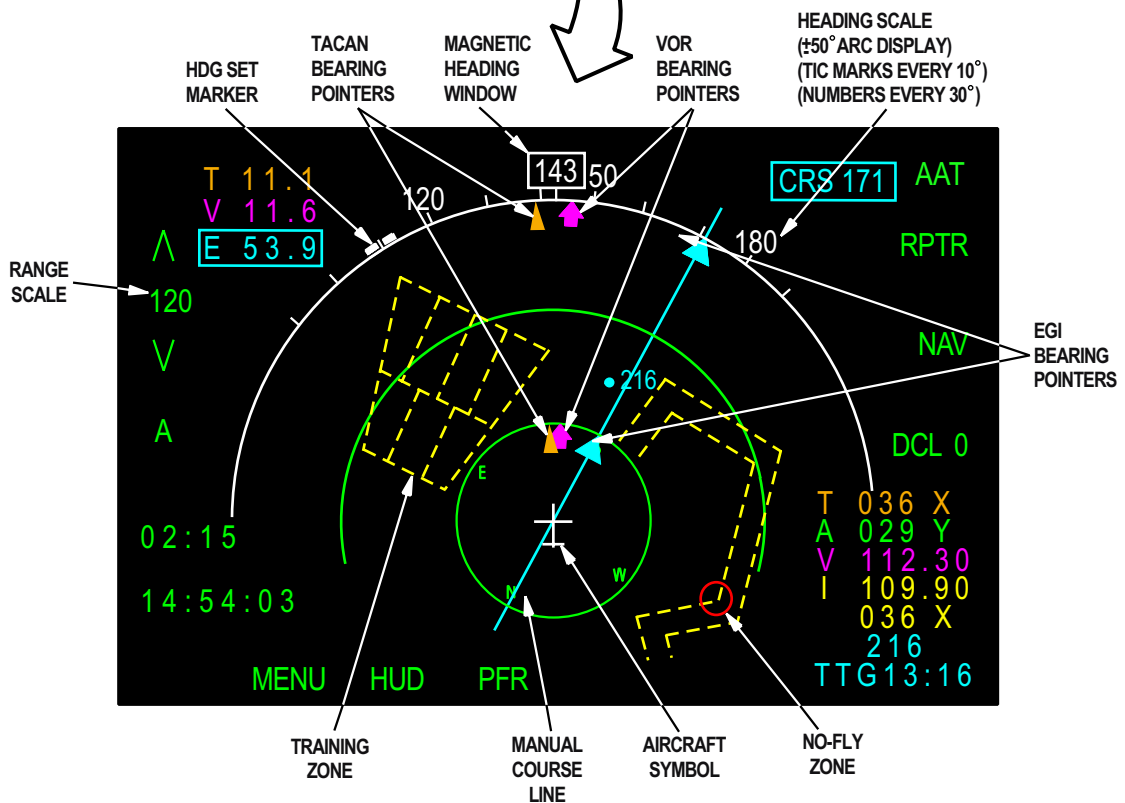

Figure 1-163. HSD Display

T38002-489-1-021

T.O. 1T-38C-1

MFD

TACAN (TCN) Bearing Pointer Symbols

The orange TCN Bearing Pointer Symbols, Figure 1-163, represent the magnetic bearing to the selected TACAN station whenever TACAN reception is valid. The symbols are displayed on the inner side of both the outer (heading scale) range and inner range scales. When the bearing is greater than 90° to either side, the TCN Bearing Pointer Symbol on the outer range scale is removed. The TCN Bearing Pointer Symbol on the inner range scale indicates the correct bearing at any angle.

HSD NAVIGATION SYMBOLS

The HSD Navigation Symbols, Figure 1-163 include the following elements.

Flight Plan Route and Waypoints

The selected FPL Route is displayed as white lines connecting all the FPL waypoints that are within the selected range scale of the HSD, Figure 1-164.



T38002-490-1-020

Figure 1-164. Stick Map of Selected FPL

NOTE

While the white lines represent rhumb lines (mercator map projection) between the waypoints, the EGI provides a great circle course from one waypoint to the next. On longer flight plan legs, this could result in a centered CDI display on the EHSI while the aircraft is shown off the white rhumb line of the HSD. This display difference is greatest around the half way point between two waypoints. For example, when half way between two waypoints 200 nm apart, the HSD may show the aircraft 1 nm off the white flight plan line.

Waypoints In A Flight Plan

The waypoints are represented by a bold white dot at the relative location with the steerpoint labeled. When EGI is not the PNS the steerpoint in a FPL is not labeled. A single FAF and APT (airport) symbol, Figure 1-165, is displayed for waypoints with those steering types (regardless of selected PNS); refer to FLIGHT PLAN NAVIGATION, this section.



T38002-491-1-020

Figure 1-165. Waypoints in a Flight Plan

Steerpoint Not In A Flight Plan

When a destination point or ICAO point is selected as the steerpoint, the system displays that point and its name as well as a line representing the Manual Course Line to that point. The point is displayed by a bold cyan dot with the identifier presented to the right of the point, Figure 1-166.



Figure 1-166. Steerpoint Not in a Flight Plan

Manual Course Line

The cyan Manual Course Line to the steerpoint is drawn through this point to the HSD display limits in both directions, Figure 1-167. The Manual Course Line is displayed only when EGI is the PNS. The MDP moves the Manual Course Line as the great circle course to the steerpoint is updated



Figure 1-167. Manual Course Line T38002-538-1-020

NOTE

The cyan Manual Course Line is based on a rhumb line, while the EGI provides a great circle course to the steerpoint. This can result in a centered CDI on the EHSI based on the great circle course, while the aircraft is shown off the cyan course line on the HSD.

Map Symbols

In addition to the FAF and APT symbols described above, the HSD displays Map Symbols for Airports, NAVAIDs, and Waypoints, Figure 1-168 and Figure 1-169. The symbols are blue with labels below the symbols. The symbols and labels are programmed via MPC with a maximum of 5 characters and cannot be changed in the aircraft. A maximum of 20 Map Symbols can be displayed at one time on the HSD even though more are programmed via the MPC. If more than 20 HSD Map Symbols are within the HSD display range then the DCL 0/1/2 label at MR-6 turns yellow and Map Symbols are removed based on symbol group (Waypoints, NAVAIDs, Airports) and distance from the aircraft. Waypoint Map symbols are removed first, starting with those farthest from the aircraft. When all waypoints are removed, the farthest NAVAIDs are removed as needed to keep the total number to 20. Airports are removed only after all Waypoints and NAVAIDs have been removed. Figure 1-169 shows the symbol group hierarchy.



Figure 1-168. Map Symbols

NOTE

HSD Map Symbols are available only when mission planning data is provided from JMPS.











SYMBOL GROUP	SYMBOL	SYMBOL TYPE
AIRPORTS		CIVILIAN AIRPORT
		CIVILIAN/MILITARY AIRPORT
		MILITARY AIRPORT
NAVAIDS		VOR/DME
		VOR
		VORTAC
		TACAN
		NDB
		NDB/DME
WAYPOINTS		WAYPOINT

Figure 1-169. Map Symbol Hierarchy

T38002-493-1-020

Training Zones

The HSD displays selectable Training Zones represented by thin dashed lines, Figure 1-170. Training zones may be displayed on the HSD in the following user-defined colors: yellow, cyan, green, magenta, orange, and red. The training zones are created by multiple line segments; up to 40 coordinates in each

zone. A maximum of 10 zones and their associated color can be programmed during mission planning (to include zone names) and loaded via the DTS. The zones cannot be altered after being loaded into the aircraft.

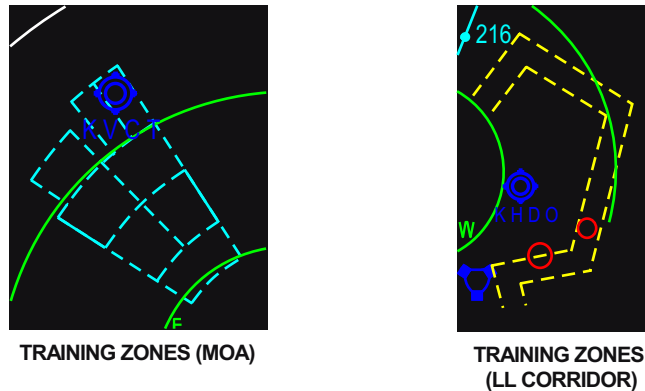

Figure 1-170. Training Zones

T38002-540-1-020

NOTE

- Training zones that are pre-selected in mission planning (JMPS only) are selected upon loading the ZONE file from DTC. Training zones that are mission planned via MPC cannot be pre-selected and must be selected once loaded in the aircraft. Refer to DATA TRANSFER SYSTEM (DTS), this section.
- If the ZONE file is not loaded, the training zones from the previous sortie are retained.
- Training Zones color is limited to yellow unless mission planning data is provided from JMPS.



Figure 1-171. No-Fly Zones

T38002-541-1-020

NOTE

- No-fly zones that are pre-selected in mission planning (JMPS only) are selected upon loading ZONE file from DTC. No-fly zones that are mission planned via MPC cannot be pre-selected and must be selected once loaded in the aircraft. Refer to DATA TRANSFER SYSTEM (DTS), this section.
- If the ZONE file is not loaded, the selected no-fly zones from the previous sortie are retained.

No-Fly Zones

The HSD displays selectable No-Fly Zones represented by red solid-line circles, Figure 1-171. The No-Fly Zones are grouped into sets of up to 10 circles; up to 10 groups may be selected at one time. The MDP is capable of loading up to 100 circles from the DTS (10 groups of 10 circles). No-fly zones are not editable in the aircraft

Bullseye Symbol

The green Bullseye symbol, Figure 1-172, is displayed in relation to ownship aircraft on the HSD, Figure 1-146 (Sheet 3). The bearing and range information from the bullseye to ownship aircraft is displayed on the HSD in the lower left corner of the MFD. The bearing and range format is BXXX/XXX. Bearing is

T.O. 1T-38C-1 MFD

displayed as 001°-360° and range as 000-999 NM. The bullseye bearing, range, and symbol are displayed in all master modes when enabled on the UFCP Bullseye Key Display. Refer to UFCP FUNCTION KEYS , this section.



BULLSEYE REFERENCE POINT

T38002-542-1-020

Figure 1-172. Bullseye Symbol

HSD MFD OPTION SELECT BUTTON (MOSB) LABELS AND FUNCTIONS

HSD MOSB labels and functions, Figure 1-173, work in the same manner as the PFR MOSB labels and functions described in this section with the following exceptions. ML-4 and ML-5 control the Range Scales on the HSD independent of the status of TCAS. The declutter label at MR-6 turns yellow if more than 20 HSD Map Symbols are within the display range of the HSD and some symbols are being automatically decluttered.



Figure 1-173. HSD MFD Display

T38002-543-1-021

MFD MENU AND FUNCTION DISPLAY PAGES

MFD MULTILEVEL MENU CONTROL

Several function pages containing information regarding aircraft systems, navigation and weapons employment can be selected from the MENU page

(selected via MB-1), Figure 1-174. Some pages allow data manipulation within the MDP and some pages are for display only.

Selecting MENU from any display page returns to the MENU Display Page. Selecting PFR/HSD/HUD returns to the selected flight display.



Figure 1-174. Menu Display Page

T38002-544-1-020

NOTE

All function pages are selected manually except SCOR, which can be selected manually or is automatically displayed upon A/G weapon release. Refer to T.O.1T-38C-34-1-1.

MENU DISPLAY OPTIONS

The following options are displayed on the MENU Display Page and can be selected by pressing the adjacent OSB.

ML-1 TEST

Pressing ML-1 (TEST) on the MENU Display Page selects the TEST Display Page, see Figure 1-175. This page is designed generally for ground maintenance use to test functionality, monitor signals, and initiate selected avionics system tests of the following:

a. MFD - ML - 3: selects the TEST Display Page for testing the functionality of the MOSBs.

b. DSCIN (DISCRETE IN) - ML-4: selects the DSCIN Display Page for monitoring the status of the input discrete signals to the MDP.

c. IBIT - MR-3: selects the IBIT Display Page. It is only available on the ground and is normally the only test function aircrew may be required to perform.

The IBIT can be performed on the following avionics system/components:

- (1) EGI
- (2) TCAS
- (3) RALT
- (4) UFCPF (FCP UFCP)
- (5) UFCPA (RCP UFCP)
- (6) TACAN
- (7) DTS
- (8) ADC
- (9) YSAS

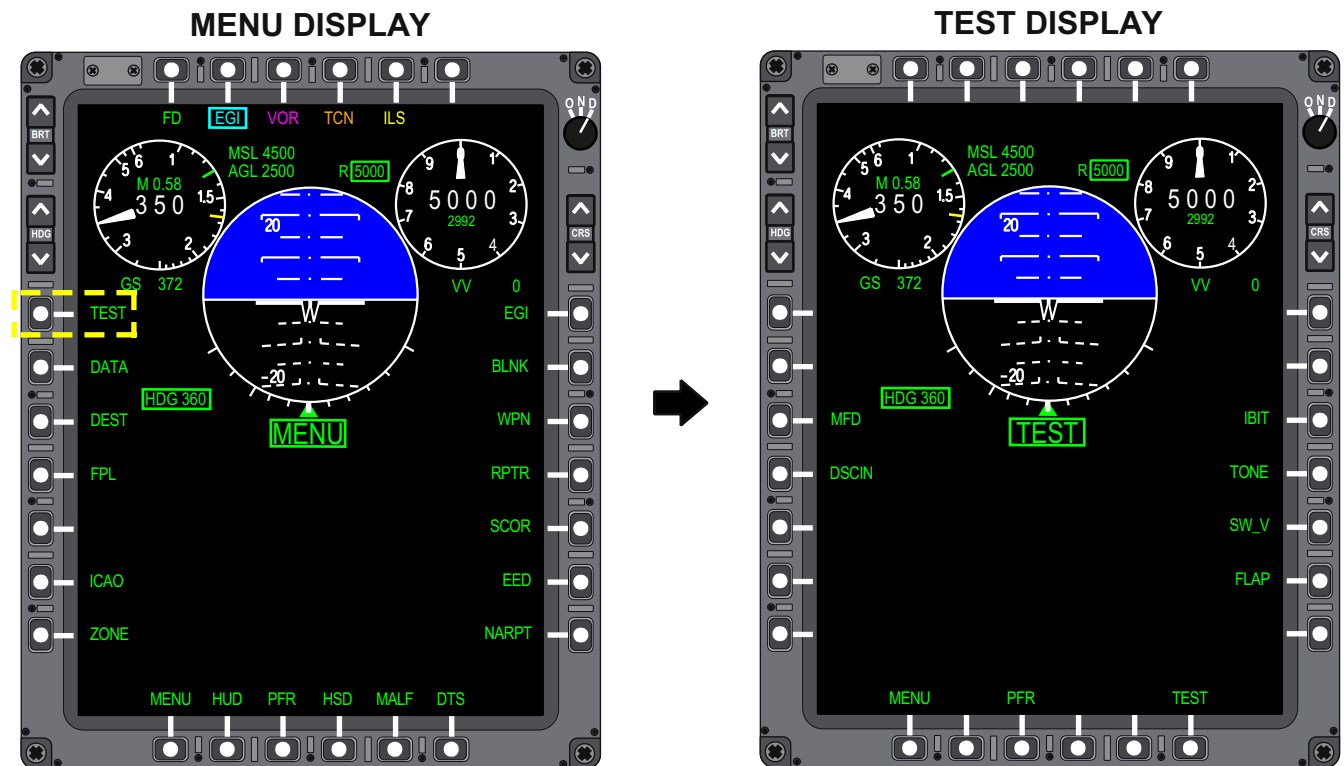

T38002-545-1-020

Figure 1-175. Test Display Page

T.O. 1T-38C-1

MFD

- (10) MFDF (FCP MFD)
- (11) MFDA (RCP MFD)

Refer to SYSTEMS MONITORING AND TEST, this section.

d. TONE - MR-4: selects the AURAL TONE Display Page for testing the functionality of the aural warning tones. When an option button is pressed, the appropriate tone is generated for 3 seconds (only one tone can be generated at a time):

- (1) STALL
- (2) GEAR
- (3) M/ALT (Altitude Warning)
- (4) OV_G (alternating tone)
- (5) G_EXC (continuous tone)
- (6) HI_G (double rate beep)
- (7) MED_G (single rate beep)
- (8) CMD (chaff/flares)
- (9) RLSE (weapon release)

Refer to WARNING/CAUTION/ADVISORY (WCA) SYSTEM, this section.

e. SW_V - MR-5: selects the MDP Display Page. The current MDP software version and date is displayed.

f. FLAP - MR-6: selects the FLAP ANGLE Display Page. Actual flap position, in degrees deflection, is displayed.

g. MENU - MB-1: selects the MENU Display Page.

h. PFR - MB-3: selects the PFR Display Page.

i. TEST - MB-6: selects the TEST Display Page; on all TEST Sub-Menu Displays, TEST is displayed boxed at MB-6 and enables a direct return to the TEST menu.

Exit from the TEST Display Page is accomplished by selecting MENU (MB-1), PFR (MB-3) or DDS.

ML-2 DATA

Pressing ML-2 (DATA) on the MENU Display Page selects the DATA Display Page, Figure 1-176.

NOTE

- The OAT on the DATA Display Page is inaccurate during ground operations with the pitot heat ON.
- ML-7 is for maintenance use only.

The following data selection options are provided:

a. BRST (Boresight) - ML-3-Displays the EGI Boresight parameters and is for maintenance use only. This MOSB is available with WOW only.

b. PMP/NO_PMP - MR-5-Shows the type of engine selected (PMP or NO_PMP) to ensure appropriate data is used for divert calculations. The title SET ENGINE flashes until MR-5 is selected after the MDP software is loaded. Every time the tail number is changed, the PMP selection flashes SET ENGINE until an engine type is selected. Selecting the engine type is typically a maintenance function.

NOTE

If the engine type, PMP or NO_PMP, has not been selected, the DVT mode is inoperative on the UFCP at UL-4 on the TOT Sub-Menu Display.

MENU DISPLAY



DATA DISPLAY

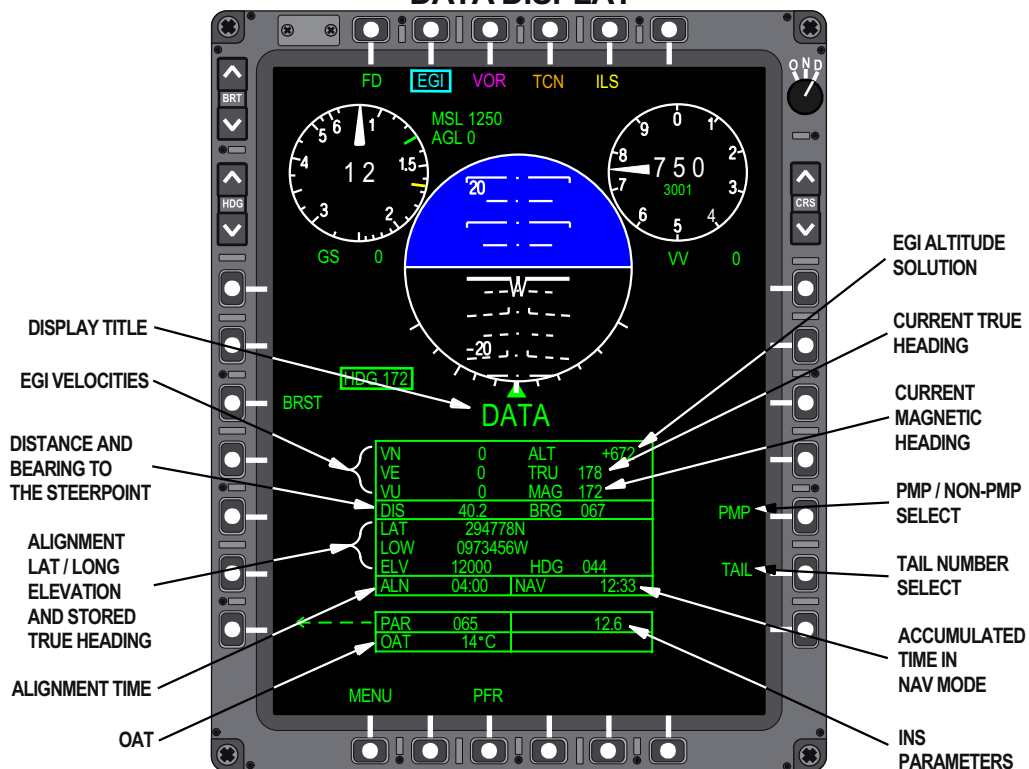

Figure 1-176. Data Display Page

T38002-546-1-020

T.O. 1T-38C-1

MFD

c. TAIL - MR-6 - Displays aircraft tail number. Pressing MB-2 on the DATA TAIL NUMBER Display Page clears the current tail number and allows a new 6 digit tail number to be entered using the numeric menu (ML-2 thru ML-6 and MR-2 thru MR-6) with completion after the last digit is entered; if only the last 4 digits are entered, MR-7 (ENTR) must be pressed to complete entry. Engine type must be entered when a new tail number is selected.

d. MENU - MB-1: selects the MENU Display Page.

e. PFR - MB-3: selects the PFR Display Page.

Exit from the DATA Display Page is accomplished by selecting MENU (MB-1), PFR (MB-3) or DDS.

ML-3 - DESTINATION (DEST)

Pressing ML-3 selects the DEST Display Page, Figure 1-177, which displays the stored destination points. The selected destination number and page number is shown in the center of the display. There are two available formats for the DEST Display Page; World Geodetic System (WGS), which presents the Latitude and Longitude, and Universal Transverse Mercator (UTM), which presents the Military Grid Reference System (MGRS) coordinates. The display format is selectable on the UFCP TOT Sub-Menu Display. When WGS is the selected format, each row of data represents the destination number, latitude, longitude, elevation, and TOT. When UTM is the selected format, each row of data represents the destination number, MGRS coordinate, elevation, and TOT. The DEST Display Page consists of multiple pages that list all of the destination points in numerical order.

a. When DEST is selected, the initial DEST Display Page is determined by the current DEST point selected on the UFCP. Other destination pages can be viewed by:

- (1) Pressing MB-5 (BACK) to cycle backwards through the numerical order of stored destination points.
- (2) Pressing MB-6 (NEXT) to cycle forward through the numerical order of stored destination points.

b. A destination can be directly selected on the DEST Display Page by typing the 3-digit numerical value by using the numeric menu (ML-1 through

ML-5 and MR-1 through MR-5). After entry of the third (last) digit, the display updates to the page that the selected destination is on.

- (1) Pressing MB-2 (CLEAR) deletes any errors made when entering the first or second digits of the manually selected destination point.

c. MENU - MB-1: selects the MENU Display Page.

d. PFR - MB-3: selects the PFR Display Page.

Exit from the DEST Display Page is accomplished by selecting MENU (MB-1), PFR (MB-3) or DDS.

ML-4 - FLIGHT PLAN (FPL)

Pressing ML-4 (FPL) on the MENU Display Page selects the FPL Display Page, Figure 1-178. The default FPL Display Page is determined by the current FPL on the UFCP. Flight plan data is divided into 10 pages, one page per flight plan, and can be viewed on the FPL Display without changing the steerpoint on the UFCP. However, if the selected flight plan is changed via the UFCP, corresponding MFD changes occur.

The selected flight plan number and description are shown in the center of the display. Each row of data presents the following:

- a. WP - Waypoint.
- b. DEST - Destination number or ICAO ID.
- c. GRP - Group Letter.
- d. ID - ICAO/FAA ID.
- e. STR - Steering Type.
- f. ELEV - Elevation.
- g. TOT - Time on Target.

The last row of any flight plan is displayed with 999 in the DEST column and the remaining columns are blank. The previous DEST point (prior to 999) is the last point of the flight plan. Waypoint 00 is permanently assigned the DEST point 200 (the EGI alignment point).

MENU DISPLAY



DEST DISPLAY PAGE - WGS FORMAT



DEST DISPLAY PAGE - UTM FORMAT



Figure 1-177. Destination (DEST) Display Page

T38002-547-1-020

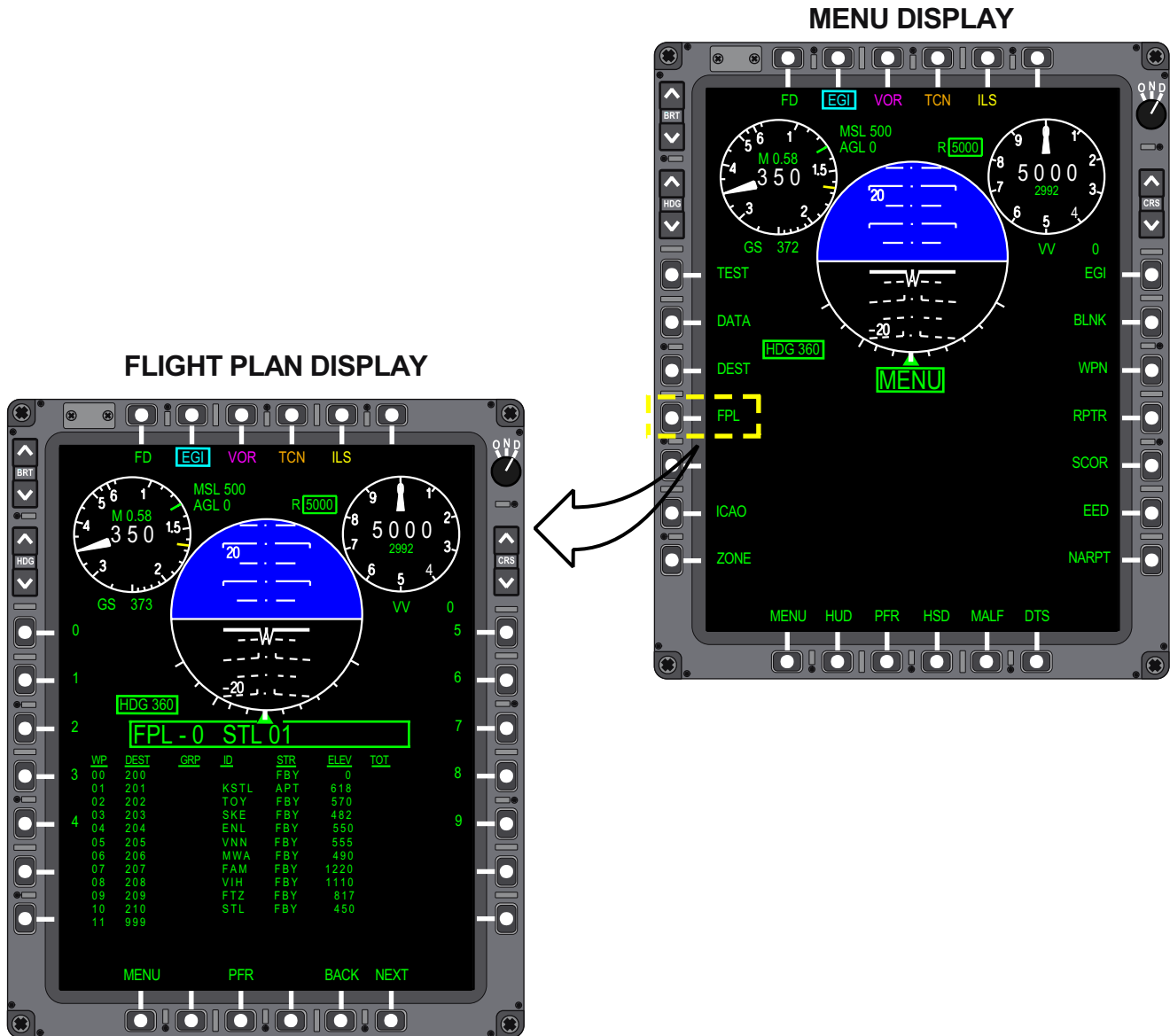

T38002-548-1-020

Figure 1-178. Flight Plan (FPL) Display Page

The following data selection options are provided:

- a. Numerals 0 thru 9 (ML-1 thru ML-5 and MR-1 thru MR-5) can be pressed to view flight plans 0 thru 9.
- b. BACK - MB-5: cycles backwards through the numerical order of flight plans.

- c. NEXT - MB-6: cycles forward through the numerical order of flight plans.
- d. MENU - MB-1: selects the MENU Display Page.
- e. PFR - MB-3: selects the PFR Display Page.

Exit from the FPL Display Page is accomplished by selecting MENU (MB-1), PFR (MB-3) or DDS.

ML-6 - ICAO

Pressing ML-6 selects the ICAO Display Page, Figure 1-179 which is used to display the stored ICAO points with their assigned ID, group letter, latitude/longitude coordinates and elevation data (if available). Each ICAO page is titled with ICAO ID of the

first stored entry of that page followed by the page number. The ICAO Display Page consists of multiple pages that list all of the ICAO points in alphabetical order; if numbers are included, they are stored after the last alphabetic character.

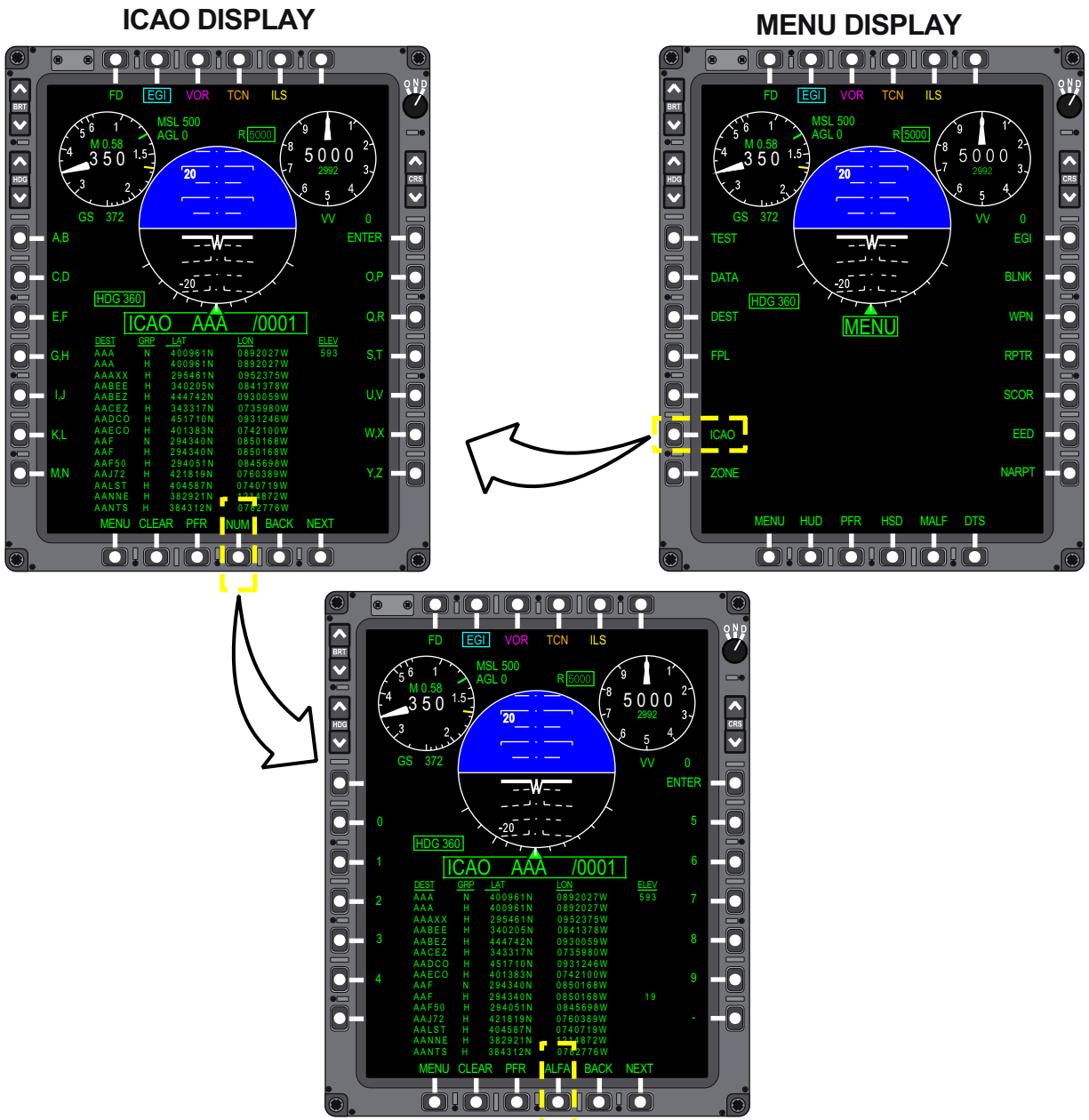

Figure 1-179. ICAO Display Page

T38002-549-1-020

Each row of data presents the following:

- ICAO - (DEST) ID.
- Group Letter - (GRP).
- Latitude - (LAT).
- Longitude - (LON).
- Elevation - (ELEV).

the UFCP. Other ICAO Display Pages can be viewed by:

- Pressing MB-5 (BACK) to cycle backwards through the ICAO Display Pages.
- Pressing MB-6 (NEXT) to cycle forward through the ICAO Display Pages.

When ICAO Display Page is selected, the initial page is determined by the current ICAO point selected on

An ICAO point can be directly selected for viewing on the ICAO Display Page by entering the ICAO ID (up to 6-characters).

a. Enter the ICAO ID using the alphabetic menu (ML-1 thru ML-7 and MR-2 thru MR-7). A single press enters the first letter adjacent to the MOSB. A double press enters the second letter.

b. When the selection requires numeric data, pressing MB-4 toggles between the alphabetic (ALFA) and the Numeric (NUM) menus. The default is the alphabetic menu.

c. Pressing MB-2 (CLEAR) deletes the error made when entering the ICAO ID.

d. Pressing MR-1 (ENTER) is used to complete an entry.

MENU - MB-1: selects the MENU Display Page.

PFR - MB-3: selects the PFR Display Page.

Exit from the ICAO Display Page is accomplished by selecting MENU (MB-1), PFR (MB-3) or DDS.

ML-7 - ZONE

Pressing ML-7 (ZONE) on the MENU Display Page selects the TRAINING ZONES Display Page, Figure 1-180. The NO-FLY ZONES Display Page is accessed from the TRAINING ZONES Display Page by pressing ML-7 (toggles between T-ZONE and NO-FLY). Up to 10 training zones and 10 no-fly zones loaded via the DTC are available for display.

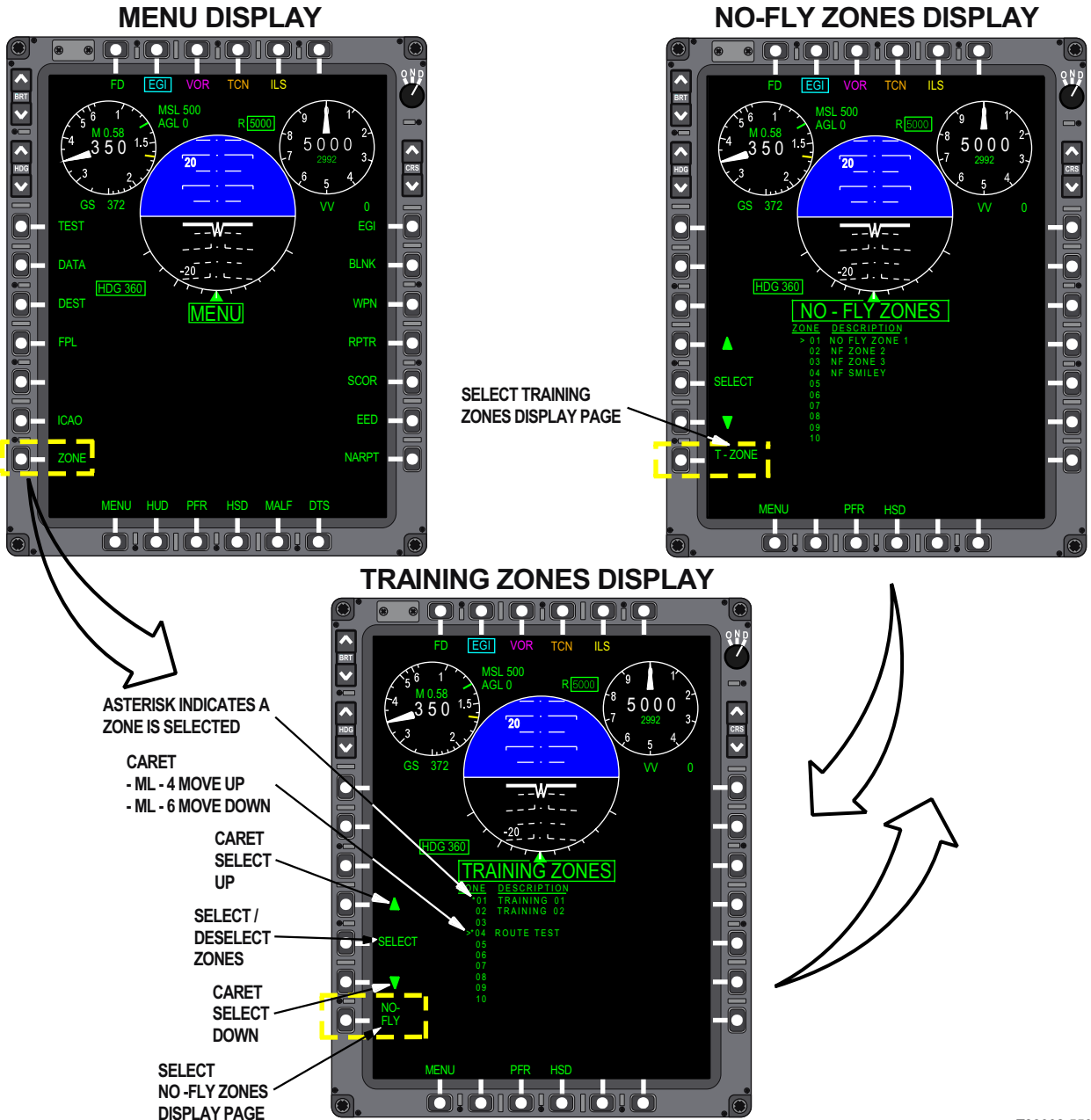

Figure 1-180. Zones Display Page

T38002-550-1-020

The following data selection options are provided:

a. Training and no-fly zones can be selected for display on the HSD as follows:

- (1) ML-4 (up) and ML-6 (down) cycles through the available zones. A caret is displayed next to the zone row to be selected or deselected.
- (2) ML-5 (SELECT) toggles an asterisk (*) on and off next to the zone with the

caret. An asterisk indicates which zone(s) will be displayed on the HSD.

- b. MENU - MB-1: selects the MENU Display Page.
- c. PFR - MB-3: selects the PFR Display Page.
- d. HSD - MB-4: selects the HSD Display Page.

Exit from the TRAINING ZONES Display Page or the NO-FLY ZONES Display Page is accomplished

by selecting MENU (MB-1), PFR (MB-3), HSD (MB-4) or DDS.

MR-1 - EGI

Pressing MR-1 selects the EGI Display Page, Figure 1-181, which displays the current EGI operating data and status as follows:

a. EGI MODE of operation:

- (1) When EGI is OFF or failed, OFF is displayed.
- (2) When EGI is first turned ON:
 - (a) STBY is displayed.
 - (b) ATT [Refer to Attitude (ATT) Mode, this section.]

(3) During EGI alignment, type of alignment:

- (a) Stored Heading (SH).
- (b) Gyro Compass (GC) when SH required conditions are not fulfilled/available.
- (c) In-Flight Alignment (IFA).

(4) When EGI transitions to navigation mode (by aircraft movement or aircrew command), the currently selected source of navigation data is displayed:

- (a) NAV/EGI (blended solution).
- (b) NAV/INS (INS only).
- (c) NAV/GPS (GPS only).

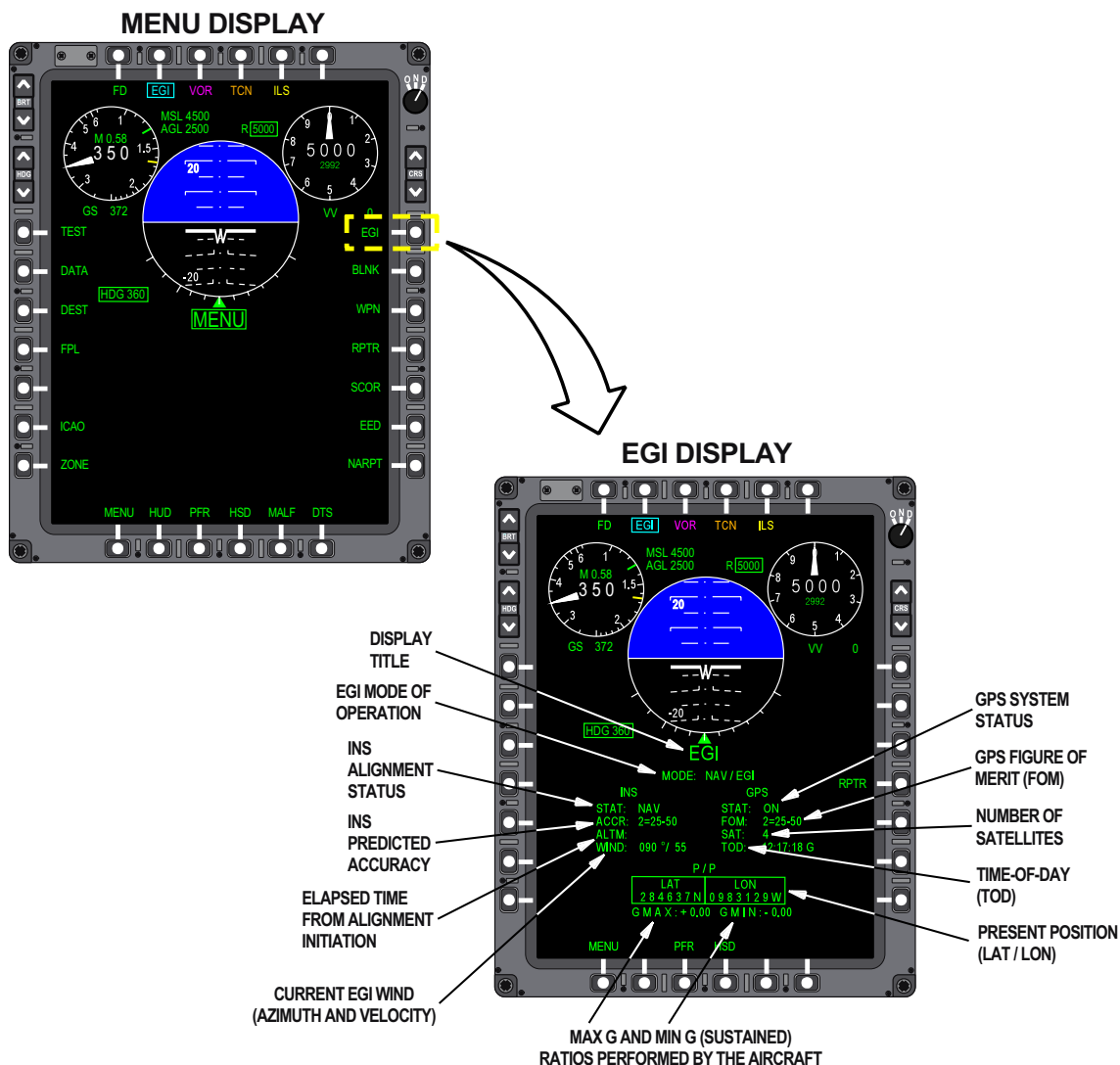

Figure 1-181. EGI Display Page

T38002-551-1-020

T.O. 1T-38C-1
MFD

b. INS status is presented as follows:

- (1) During Alignment:
 - (a) STAT (current alignment status):
 1. WAIT (should not move aircraft).
 2. LEVEL (maintain straight and level flight - Air Align only).
 3. FULL (fully aligned EGI with at least 0.8 NM/hr accuracy).
 4. IFA (EGI is in-flight alignment with GPS available).
 5. DEG (alignment in progress and accuracy is degraded).
 6. For Air Align, STAT is blank after LEVEL until full alignment.
 - (b) ACCR (anticipated accuracy):
 1. GC-ALN: accuracy represented by drift rate (from 0.8 to 8.0 NM/hour).
 2. AIR-ALN: accuracy represented by FOM (1-9) = position error (from 25 to 5,000 meters).
 - (c) ALTM (elapsed time of alignment):
 1. Blank (if in Air Align).
 2. MM:SS (minutes and seconds of the current alignment).
 - (d) WIND
 1. Blank at the start of alignment and then displays XXX°/XXX until airborne
- (2) During Navigation
 - (a) STAT: NAV
 - (b) ACCR: Current accuracy of the selected source of navigation data.
 1. Accuracy represented by FOM (1-9) = position error (from 25 to 5000 meters).
 - (c) ALTM (elapsed time of alignment):
 1. Blank.
 - (d) WIND
 1. Airborne: Wind Speed (knots) and Direction (degrees).
 2. On the ground: XXX°/XXX

c. GPS status is presented as follows:

- (1) STAT (current GPS status):
 - (a) ON.
 - (b) OFF.
 - (c) No Satellites (NOSAT).
- (2) Figure Of Merit (FOM) representing relative position error values from 1 thru 9, followed by the range of position uncertainty in meters.

- (3) Satellites (SAT) displays the number of satellites received. Display is limited to a maximum of 4 although the EGI may be tracking up to 12 satellites.
- (4) Time-of-Day (TOD) display for GPS clock (G displayed after time) or MDP clock when there is no GPS clock received (T displayed after time).

d. Present Position (P/P) displays current latitude and longitude coordinates.

e. G maximum (GMAX) and g minimum (GMIN) displays the greatest g exceedance as a ratio of actual g's over the g limit (e.g. +1.02 equals 2 percent over g). When 0.00 is displayed, no exceedance events have occurred.

f. RPTR - MR-4: Pressing MR-4 cycles the RPTR function ON/OFF.

g. MENU - MB-1: selects the MENU Display Page.

h. PFR - MB-3: selects the PFR Display.

i. HSD - MB-4: selects the HSD Display.

Exit from the EGI Display Page is accomplished by selecting MENU (MB-1), PFR (MB-3), HSD (MB-4) or DDS.

MR-2 - BLANK (BLNK)

Pressing MR-2 (BLNK) on the MENU Display Page selects the BLANK Display Page, Figure 1-182, which is selectable in either cockpit for blanking various navigation data on the opposing cockpits MFD. The blanking options are selected as follows:

a. Pressing ML-1 (MFD BLNK) completely blanks the opposing cockpits MFD except the MOSB titles MENU and PFR and boxes MFD BLNK (ML-1) and BLNK (MR-2).

b. Pressing ML-2 (HUD BLNK) selects complete blanking of the HUD, removes all HUD symbology from the HUD Repeater Display and boxes the HUD BLNK (ML-2) and the BLNK (MR-2).

c. Pressing ML-3 (NO GS) blanks the opposing cockpit's MFD and HUD groundspeed displays and boxes NO GS (ML-3) and BLNK (MR-2). If GS is selected in the UFCP Head-Up (HUD) Key Display, TAS is displayed instead.

d. Pressing ML-4 (NO RANGE) blanks the opposing cockpit's MFD and HUD EGI range displays and boxes NO RANGE (ML-4) and BLNK (MR-2).

e. Pressing ML-5 (NO BRG) blanks the opposing cockpit's MFD and HUD EGI bearing displays and boxes NO BRG (ML-5) and BLNK (MR-2).

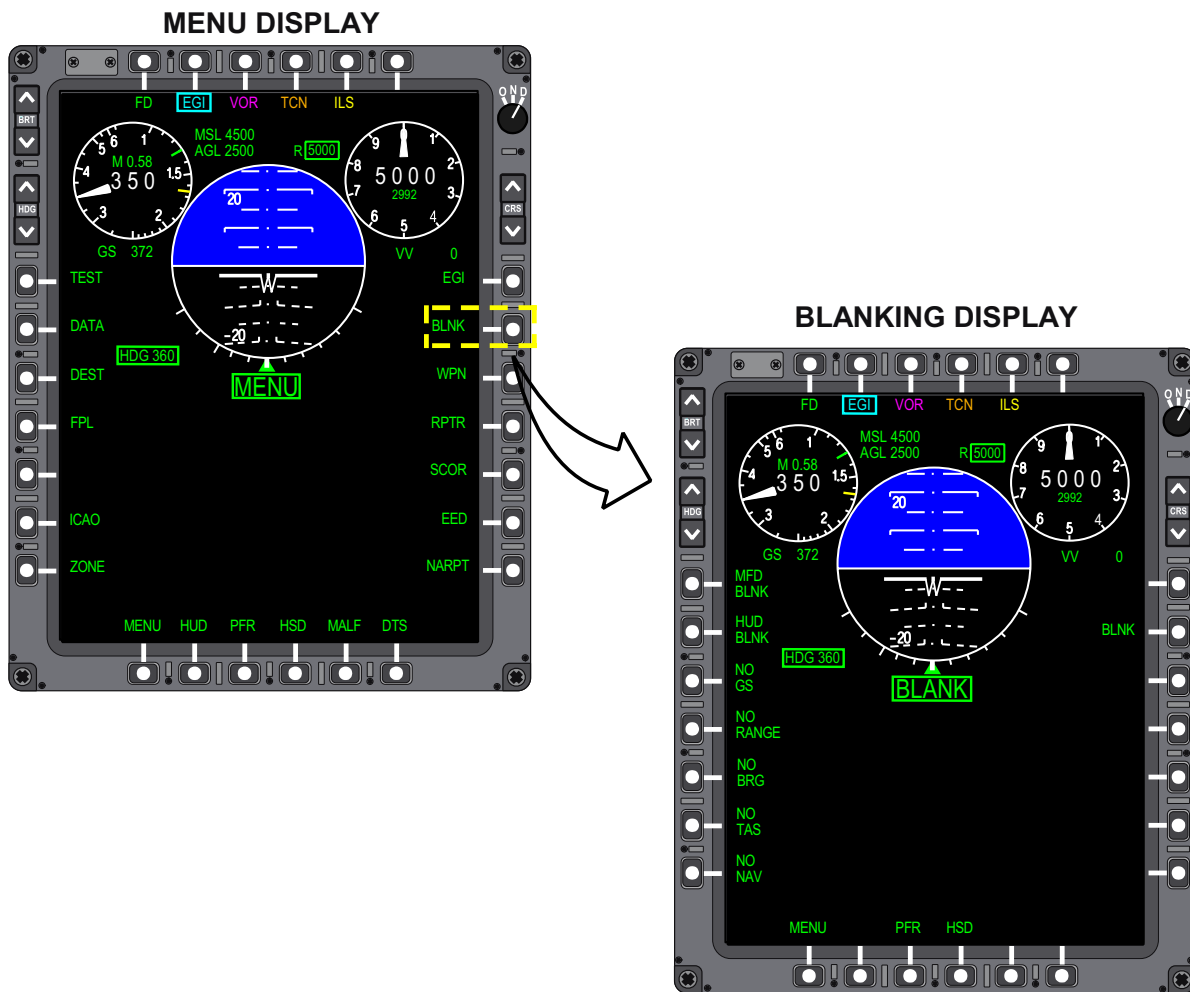

Figure 1-182. Blanking (BLANK) Display Page

T38002-552-1-020

f. Pressing ML-6 (NO TAS) blanks the HUD TAS and MFD and HUD GS displays and boxes the NO TAS title and BLNK title adjacent to MR-2 (if currently unboxed).

g. Pressing ML-7 (NO NAV) boxes and selects the NO BRG (ML-5), NO RANGE (ML-4), NO GS (ML-3) and BLNK (MR-2) blanking options.

h. Pressing MR-2 (BLNK), when boxed, deselects and unboxes all blanking option MOSB's. MR-2 is boxed when any blanking option is selected.

i. Pressing MB-1 (MENU) selects the MENU Display Page.

j. Pressing MB-3 (PFR) selects the PFR Display.

k. Pressing MB-4 (HSD) selects the HSD Display.

NOTE

NAV Blanking options initiated from the front cockpit do not affect HUD data.

The blanking function from either cockpit is inhibited when the RCP TAKE COMMAND switch is placed in OVERRIDE.

T.O. 1T-38C-1

MFD

Blanking Options -Termination

Cancellation of blanking options is accomplished in one of the following ways:

From the cockpit being blanked:

- a. Pressing the DDS. (Except when the RCP DDS is pressed for greater than one second.)
- b. Changing master modes.
- c. Selecting MENU or PFR MOSB on the MFD.

From the cockpit initiating the blanking:

- a. Pressing the associated MOSB who's title is boxed on the BLANK Display Page.
- b. Pressing MR-2 (BLNK) on the BLANK Display Page.
- c. Pressing the DDS. (Except when the RCP DDS is pressed for greater than one second).
- d. Changing master modes.

HUD blanking may also be terminated by pressing the FCP UFCP HUD Function Key.

Blanking In Combination With Repeater

When using the blanking option in combination with the repeater, the following rules apply:

- a. If the cockpit being blanked selects repeater, the unblanked cockpit is repeated. If repeater is deselected, the associated cockpit MFD returns to the previously selected blanking option.
- b. If the cockpit initiating blanking selects repeater, the blanked cockpit is repeated.
- c. If one cockpit initiates repeater and the other cockpit initiates blanking, the blanking appears in both cockpits. If repeater is deselected, the blanking appears in the appropriate cockpit.

Exit from the BLANK Display Page is accomplished by selecting MENU (MB-1), PFR (MB-3), HSD (MB-4) or DDS.

MR-3 - WEAPON (WPN)

Pressing MR-3 (WPN) on the MENU Display Page selects the WPN Display Page, Figure 1-183, which displays the current program configuration selection (profile parameters, simulated weapons, and armament count). Refer to T.O. 1T-38C-34-1-1.

Pressing ML-6 (CONFIGURATION) toggles between WSSP installed (POD) and WSSP not installed (CLEAN) configurations. This selection is used by the MDP in setting G limits, enabling the Radar Altimeter, and in Divert Mode calculations.

Exit from the WPN Display Page is accomplished by selecting MENU (MB-1), PFR (MB-3) or DDS.

MR-4 - REPEATER (RPTR)

Pressing MR-4 (RPTR) from the MENU Display Page cycles the RPTR function ON/OFF.

MR-5 - SCORE (SCOR)

Pressing MR-5 (SCOR) on the MENU Display Page selects the WEAPON DELIVERY SUMMARY Display Page, Figure 1-184. The AUTO SCORING Display Page can be viewed by pressing MR-6 (SUM) on the WEAPON DELIVERY SUMMARY Display Page. Refer to T.O. 1T-38C-34-1-1.

Exit from the Weapon Delivery Summary Display Page is accomplished by selecting MENU (MB-1), PFR (MB-3) or DDS.

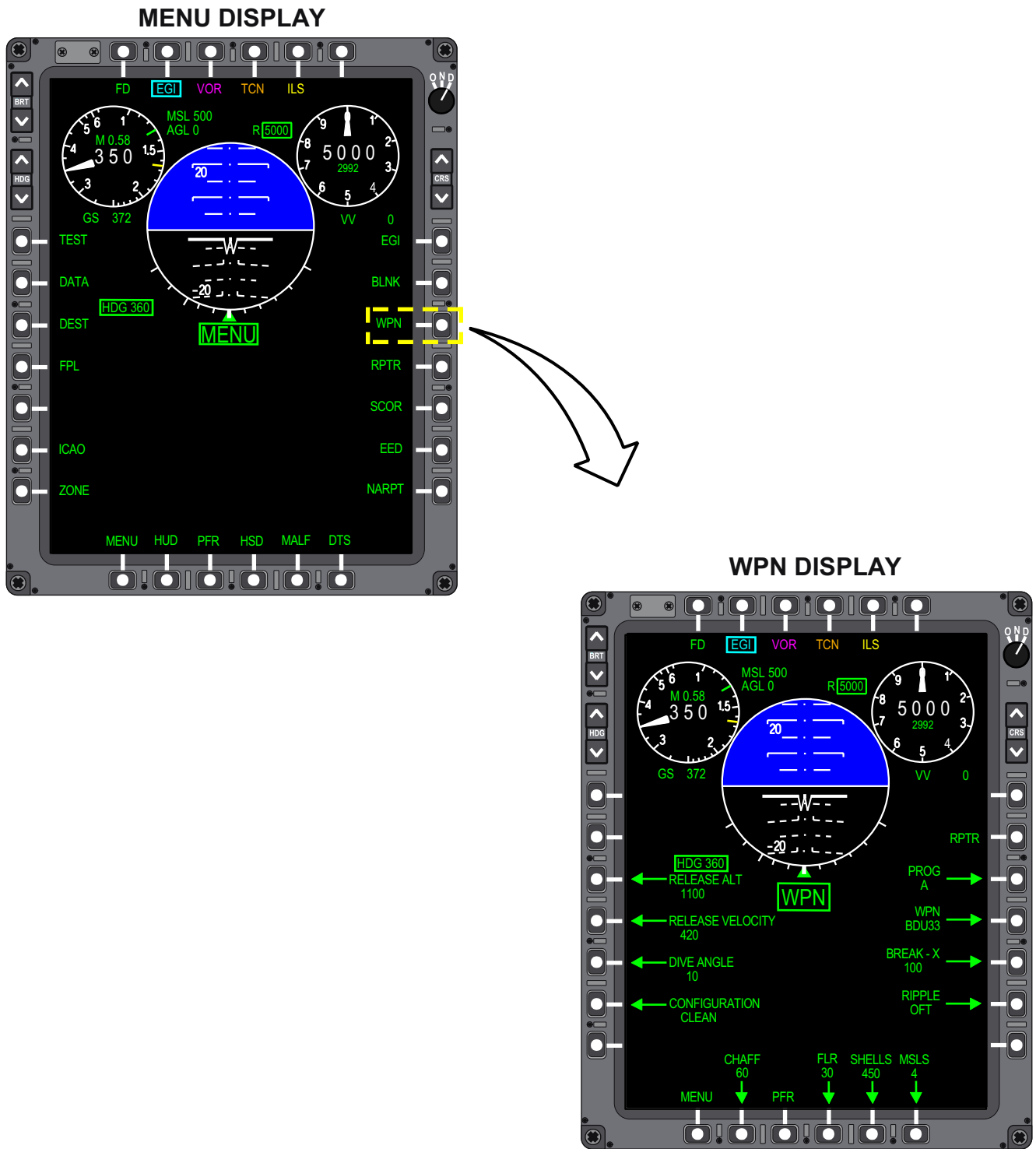

Figure 1-183. WPN Display Page

T38002-553-1-021

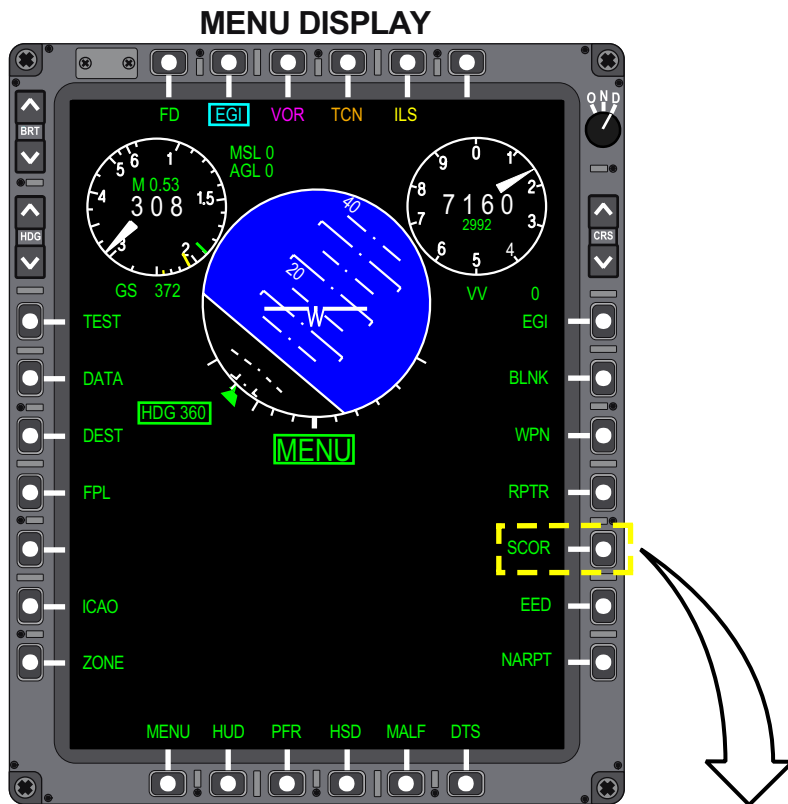
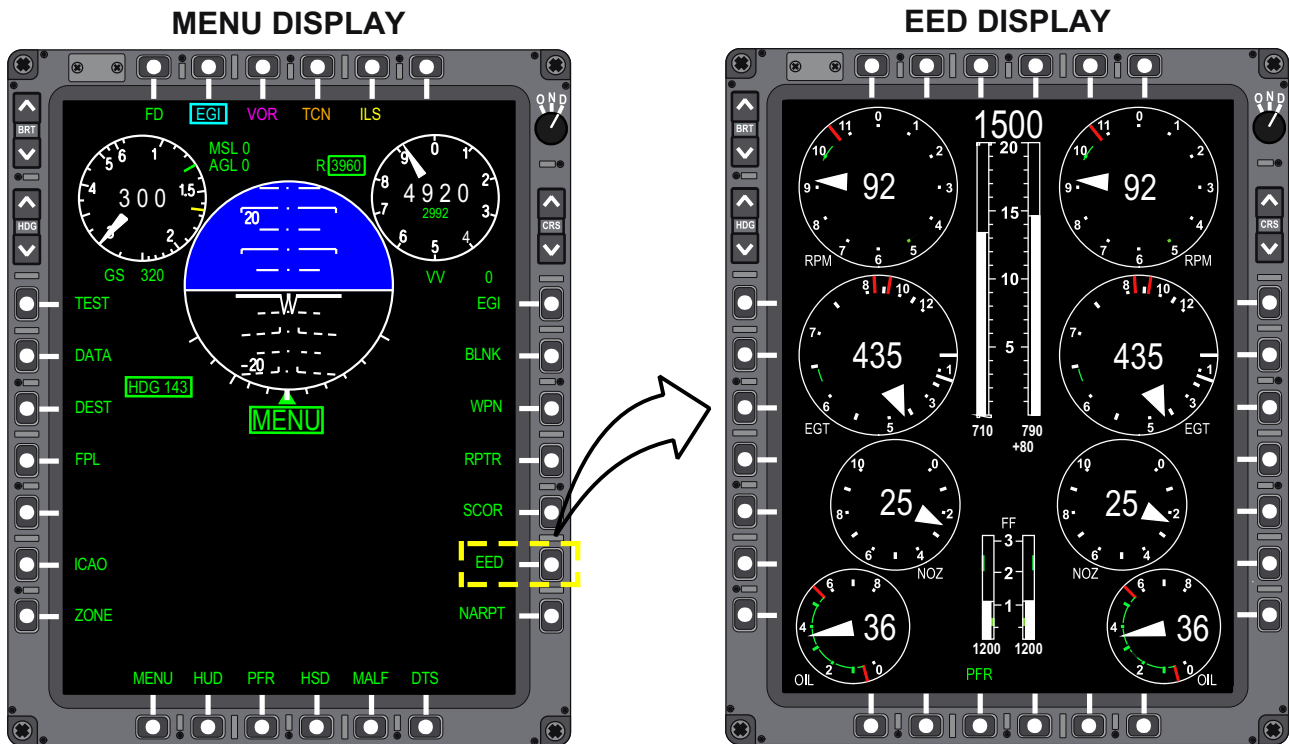

Figure 1-184. Score Display Page

T38002-554-1-021



T38002-555-1-020

Figure 1-185. Electronic Engine Display (EED) Display Page

MR-6 - EED

Pressing MR-6 (EED) on the MENU Display Page selects the EED Display Page, Figure 1-185. This display uses the entire area of the MFD. When the EED Display Page is displayed on the MFD, MB-3 (PFR) is the only selection option although MB-1 (MENU) (not displayed) is also available.

Exit from the EED Display Page is accomplished by selecting MB-1 (untitled), MB-3 (PFR) or DDS.

MR-7 - NEAREST AIRPORTS (NARPT)

Pressing MR-7 (NARPT) on the MENU Display selects the NEAREST AIRPORTS Display Page, Figure 1-186. This option allows the aircrew to view airport and runway information for the 10 airports nearest to ownship. The aircrew may select one of the 10 airports listed on the page. Selecting an airport places an asterisk to the left of the name, makes that airport the current steerpoint, and activates divert mode. Refer to NEAREST AIRPORTS, this section.

NOTE

- For engine and fuel data to display, at least one EED must be on and operating.
- The EED chronometer and the M (master) or S (slave) indication is not displayed on the EED Display Page.

T.O. 1T-38C-1

MFD

NOTE

NEAREST AIRPORTS is available only when mission planning data is provided from JMPS

Exit from the NEAREST AIRPORTS Display Page is accomplished by selecting MENU (MB-1), PFR (MB-3), HSD (MB-4) or DDS.

MB-2 - HUD

Pressing MB-2 (HUD) on the MENU Display Page selects the HUD CTVS video for full screen display independently on each cockpit MFD, Figure 1-187. The following menu options are displayed with the HUD symbols:

- a. ML-1, ML-2: Pressing ML-1 (increase) or ML-2 (decrease) controls MFD OSB label brightness.
- b. G RST (MR-2): Pressing MR-2 resets the maximum positive/negative G readout in the G Meter Display on the MFD and F-16 HUD Display to the current G value.
- c. RPTR (MR-4): Pressing MR-4 cycles the RPTR function ON/OFF.
- d. MENU (MB-1): Returns to the MENU Display Page.
- e. PFR (MB-3): Returns to the PFR Display Page.
- f. HSD (MB-4): Returns to the HSD Display Page.

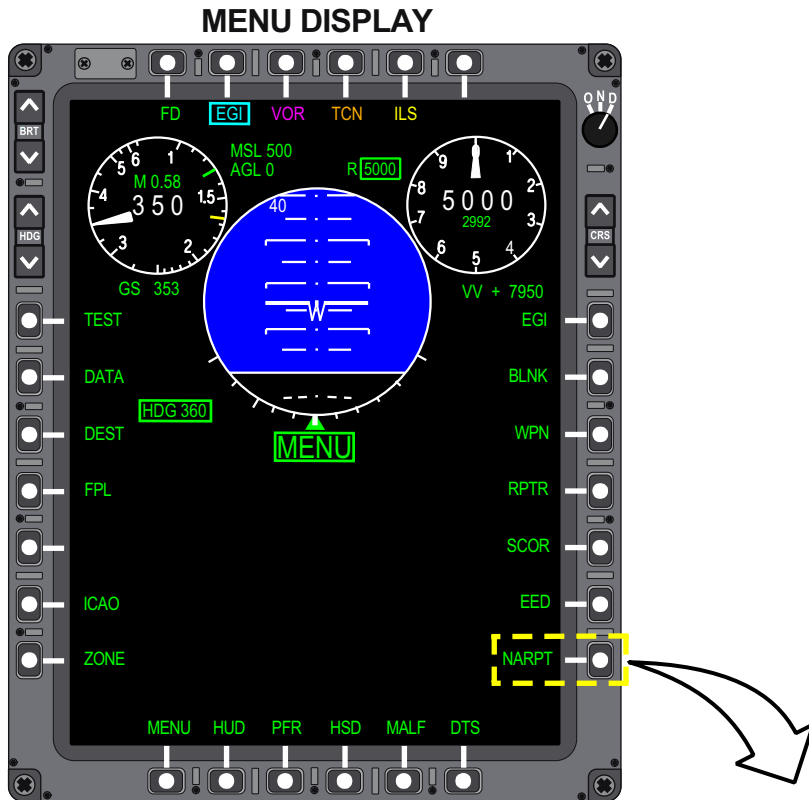

NEAREST AIRPORTS DISPLAY



Figure 1-186. Nearest Airports Display Page

T38002-556-1-020

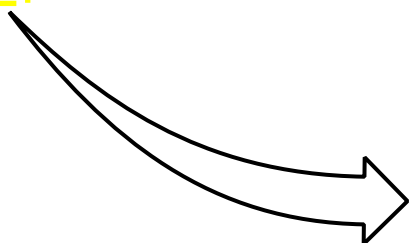

Figure 1-187. HUD Repeater Display Page

MB-5 - MALFUNCTIONS (MALF)

Pressing MB-5 (MALF) on the MENU Display Page selects the PFL Display Page, Figure 1-188 (left), and boxes MALF (MB-5) and PFL (ML-6). The title MALF is green until an unviewed PFL occurs, at which time the title turns yellow. After the PFL is viewed, or the cause of the PFL is eliminated, the color of the MALF returns to green until another unviewed PFL occurs. Refer to WARNING/CAUTION/ADVISORY (WCA) SYSTEM, this section.

Pressing ML-5 (MFL) on the PFL Display Page selects the MFL Display Page and boxes MFL (ML-5). MFLs are for maintenance use.

Exit from the PFL or MFL Display Page is accomplished by selecting MENU (MB-1), PFR (MB-3) or DDS.

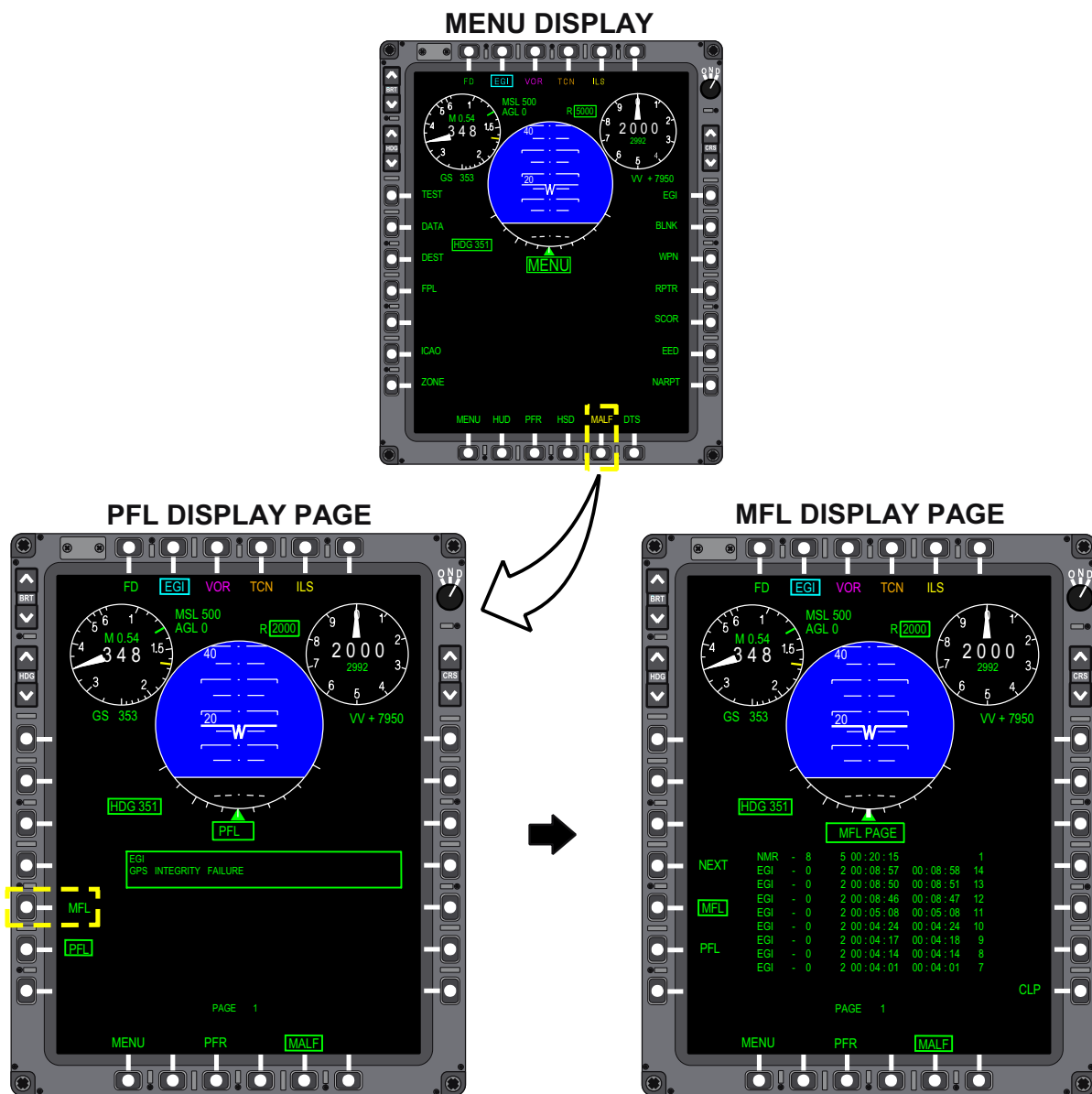

Figure 1-188. Malfunction Display Page

T38002-557-1-020

T.O. 1T-38C-1

MFD

MB-6 - DATA TRANSFER SYSTEM (DTS)

The following is a description of the Data Transfer System displays; for a complete description of system operation, refer to DATA TRANSFER SYSTEM (DTS), this section.

Pressing MB-6 (DTS) selects the DTS Display Page, Figure 1-189, for transfer of data via the DTS. When a Data Transfer Cartridge (DTC) is not inserted in the Data Transfer Drive (DTD), NO CASSETTE is

displayed in the title of the DTS Display Page. If the DTC is installed in the DTD, the DTS title is presented with the following options available:

- a. LOAD TO MDP (ML-3) - Pre-flight Data Transfer to MDP: Pressing ML-3 provides access to the LOAD TO MDP Display Page, Figure 1-190, which provides access to the data transfer pages (DTC to MDP) which are divided into two groups.

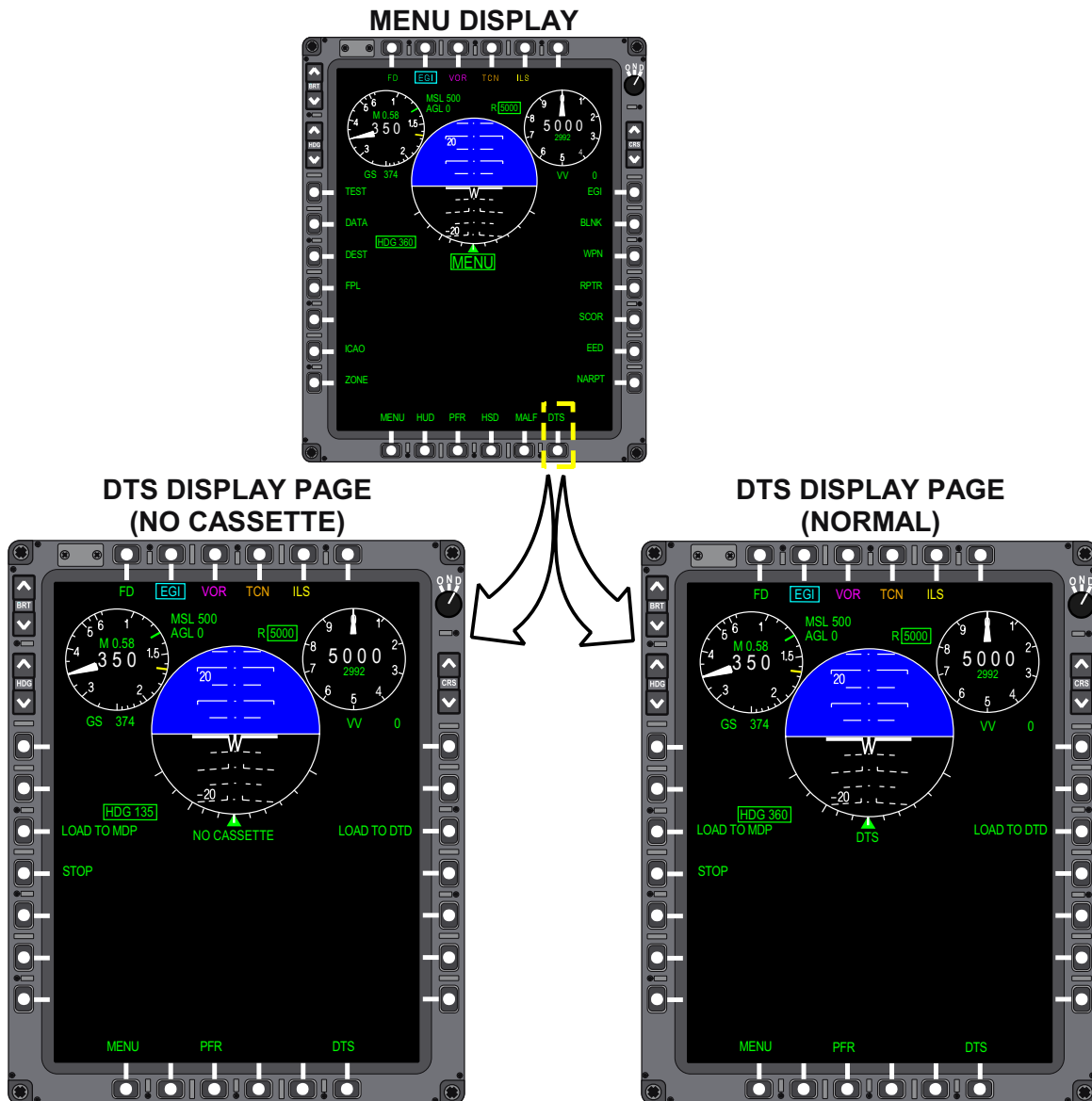

Figure 1-189. Data Transfer System (DTS) Display Page

T38002-558-1-020

- (1) Operational Data for aircrew use/update.
 - (a) OPERATIONAL 1 (ML-3).
 - (b) OPERATIONAL 2 (ML-4).
- (2) Maintenance Data for maintenance crew use/update.
 - (a) MAINTENANCE (MR-3).

b. START/STOP (ML-4): When WOW, Pressing ML-4 toggles between START (initiate) and STOP (terminate) engine data recording. This function provides aircrew the capability to manually initiate/terminate engine data recording. The title of this display is presented as:

- (1) START when data is not being recorded. Aircrew can initiate engine data recording by pressing ML-4.
- (2) STOP when data is being recorded. Aircrew can terminate engine data recording by pressing ML-4.

When Weight-Off-Wheels, the START/STOP title is displayed but ML-4 is inoperative.

- c. LOAD TO DTD (MR-3) - Post-flight Data

Transfer to DTD: Pressing MR-3 provides access to the LOAD TO DTD Display Page, Figure 1-190, which provides access to the data transfer pages (MDP to DTC) which are:

- (1) LAST (MR-3): Pressing LAST transfers MDP stored data from the last mission only to the DTC.
- (2) ALL (MR-4): Pressing ALL transfers all MDP stored data to the DTC.

Pressing MB-6 (DTS) on any of the transfer pages returns the MFD to the DTS Display Page.

NOTE

Short power interruptions can cause DTS status display to change to OFF or NO CASSETTE. The DTS recovers within 10 seconds.

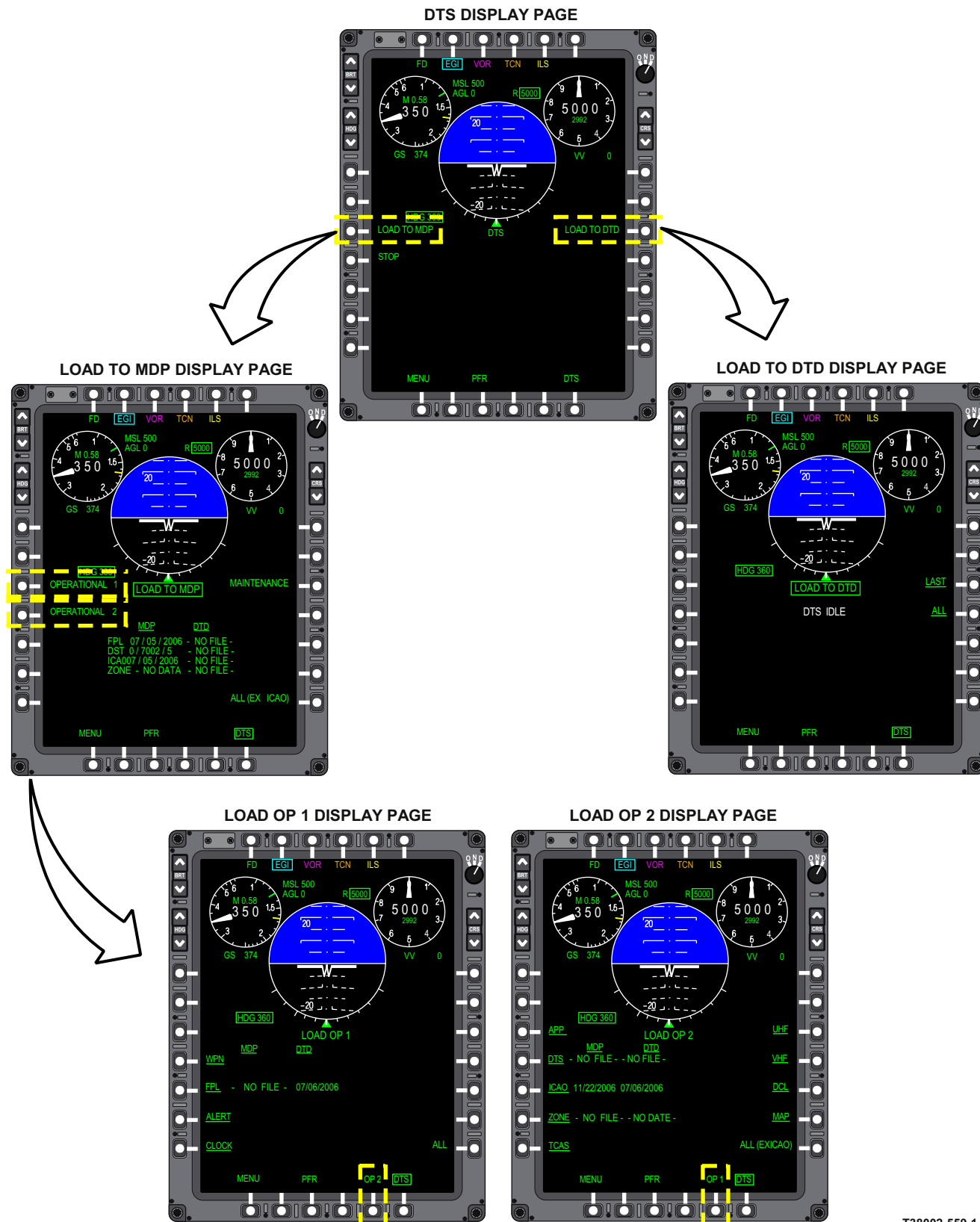

Figure 1-190. DTS Display Page

T38002-559-1-021

MFD BACKUP DISPLAY

Most displays on the MFDs are generated by the MDP. The MFD automatically enters Backup Mode under any of the following conditions:

- a. The MDP is OFF.
- b. The MFD does not detect a video signal or serial communication from the MDP (e.g., an MDP or wiring failure).

When in Backup mode, the MFD receives data from the VOR/ILS, TACAN, and EGI to generate and display a PFR display, Figure 1-191, which includes:

- a. EADI and EHSI.
- b. GS and RALT.
- c. CDI and Selected Course. The color is Orange when TCN is selected, Magenta when V/I is selected for a VOR frequency or Yellow for a Localizer frequency.
- d. VOR/ILS Frequency (controlled via NAV Backup Control Panel). The color is Magenta if a VOR frequency is tuned, Yellow if an ILS frequency is tuned.
- e. TCN Channel (controlled via TACAN B/U Control Panel). The channel is preceded by TCN for A/G, or AAT for A/A.
- f. EGI bearing/range to the steerpoint that was selected prior to entry into MFD Backup Mode.

g. VOR bearing (blanked when ILS/LOC frequency tuned).

h. DME range (Line two of Range Data Block). The color is magenta with a V identifier unless the tuning source is a localizer frequency. When a Localizer frequency is tuned the color is yellow with an I identifier. When V/I is selected the DME range is boxed. When an AAT channel is tuned, the DME range is blanked.

i. ILS VDI (raw data) for tuned station (removed from display for VOR tuned frequency or when TCN is selected).

j. TCN bearing to the tuned TACAN channel (A/G).

k. TCN range (Line one of Range Data Block) to the tuned TACAN channel (A/G or A/A). The range is preceded by T for A/G mode or A for A/A mode. When TCN is selected, the TCN range is boxed.

The O/N/D Power Knob and BRT Rocker Switch remain functional. The CRS and HDG Select Rocker Switches are functional for that cockpit only. The default setting for both selections is 360° upon entry into MFD Backup Mode.

The only operational MOSBs on the MFD Backup Display are MT-4 (TCN) and MT-5 (V/I); pressing either designates PNS selection with the adjacent title being boxed.

TCN SELECTED, VOR AND AAT TUNED

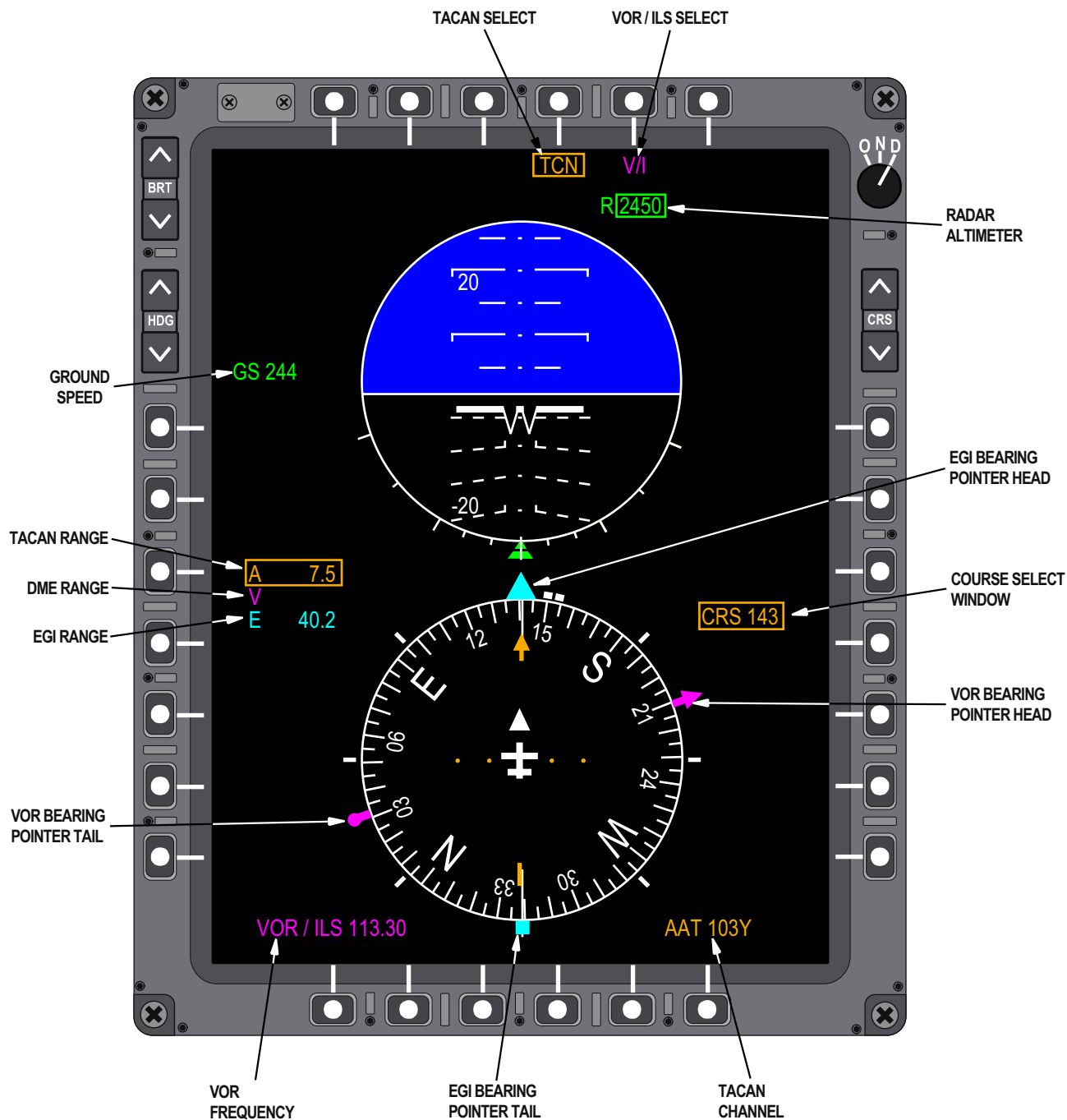

Figure 1-191. MFD Backup Displays (Sheet 1 of 4)

TCN SELECTED, ILS AND TCN TUNED

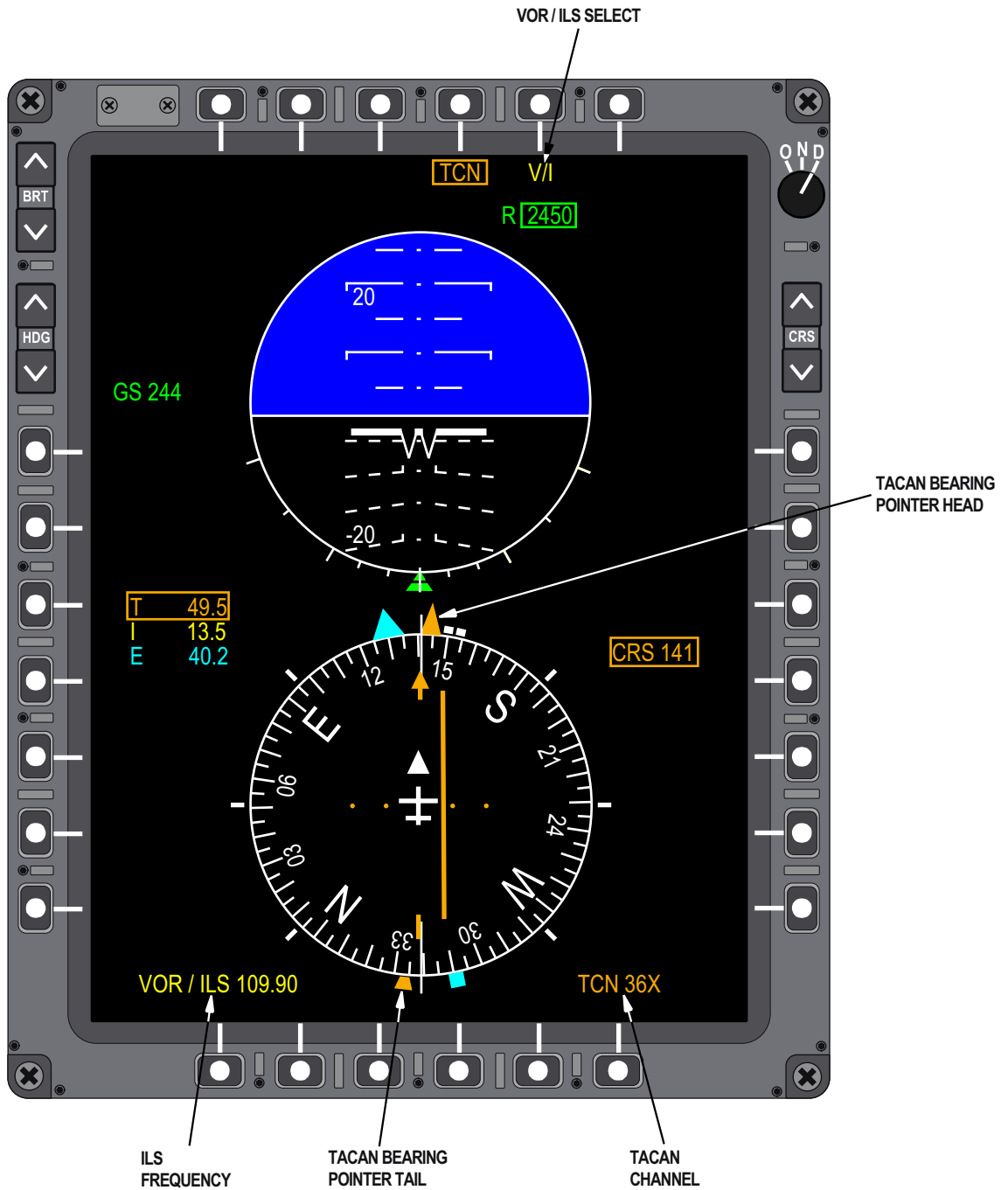

Figure 1-191. MFD Backup Displays (Sheet 2)

T38002-560-2-021

V/I SELECTED, VOR AND TCN TUNED

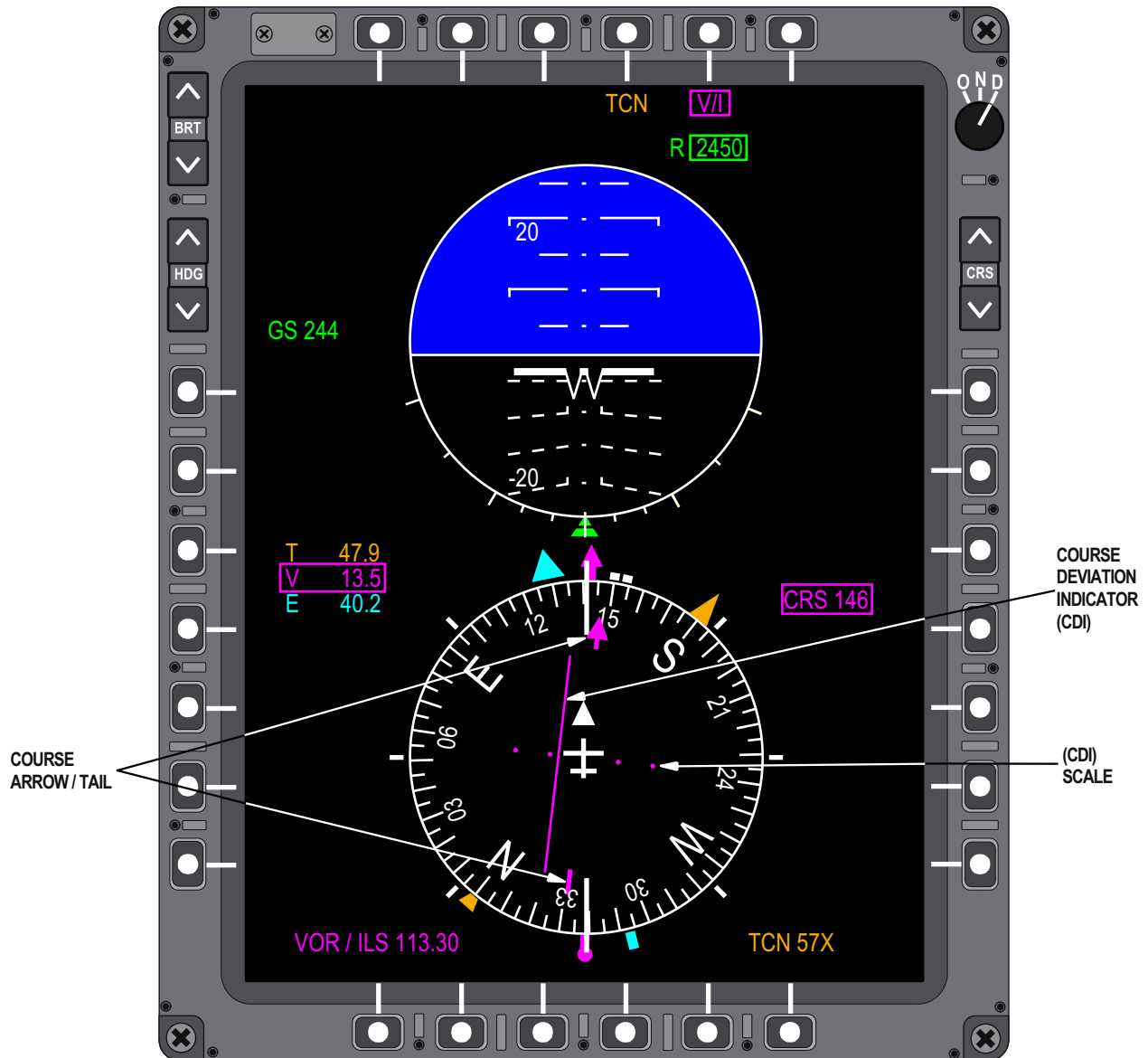

Figure 1-191. MFD Backup Displays (Sheet 3)

V/I SELECTED, ILS AND TCN TUNED

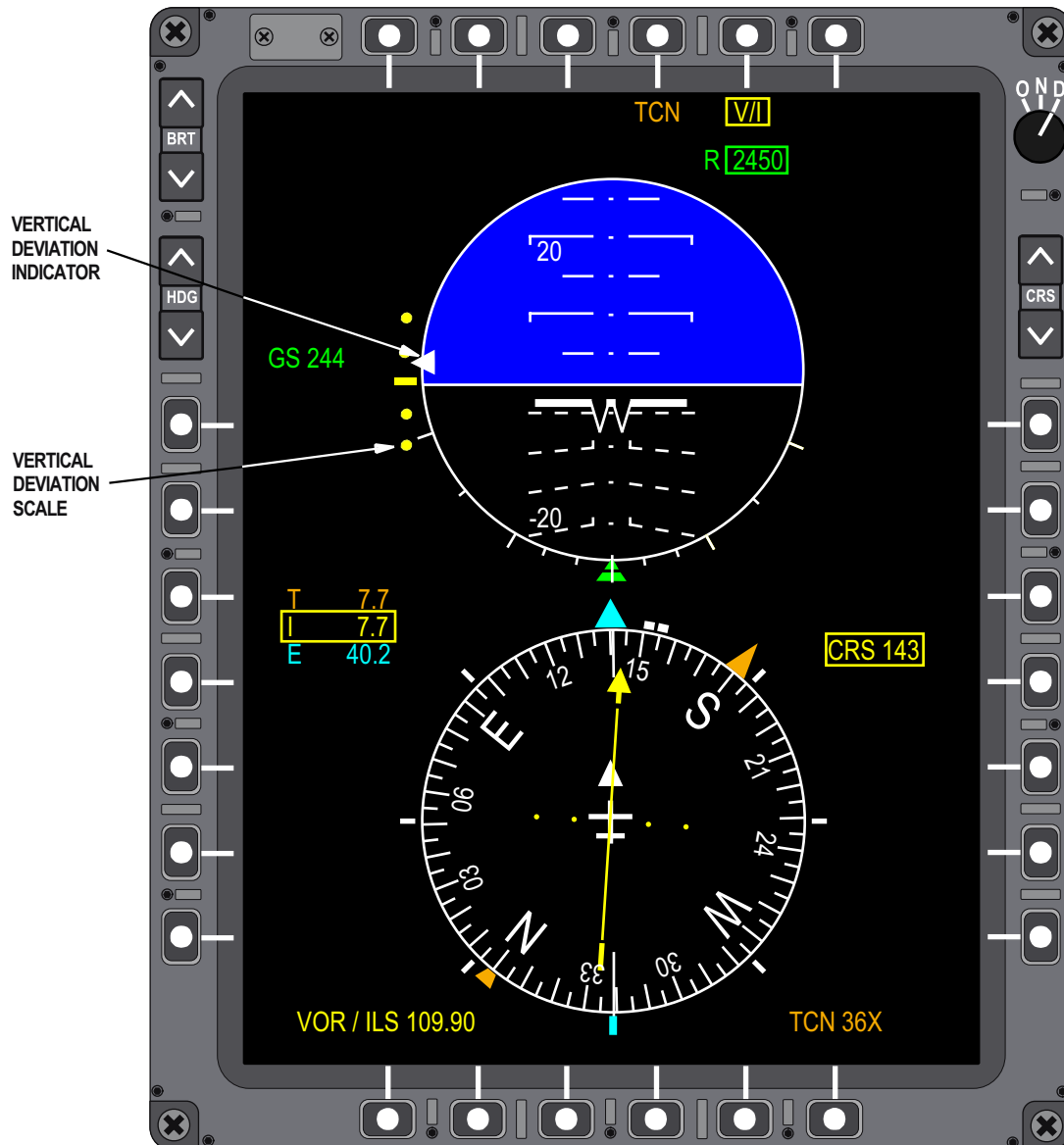

Figure 1-191. MFD Backup Displays (Sheet 4)

EMBEDDED GLOBAL POSITIONING SYSTEM (GPS)/INERTIAL NAVIGATION SYSTEM (INS) (EGI)

EGI SYSTEM OVERVIEW

The T-38C navigation system includes the Honeywell H-764G EGI which consists of the sensors and software required to generate Inertial Navigation System (INS) and Global Position System (GPS) data. The EGI also contains non-navigational subsystems to include: Radar Altimeter (RALT) and Yaw Stability Augment System (YSAS) controller. The major components of the EGI, Figure 1-192, are as follows:

a. An INS comprised of the following: three mutually orthogonal digital Ring Laser Gyros, three mutually orthogonal linear accelerometers, and processor for computing INS data, GPS data, blending INS and GPS data, and controlling the internal EGI data flow to integrate the RALT and YSAS subsystems.

b. A GPS module that receives/processes satellite signals and computes an accurate position, velocities and time.

c. A RALT module that transmits/receives radio signals to determine the aircraft height Above Ground Level (AGL).

d. YSAS module that uses INS Yaw rate, impact pressure from the ADC, and pilot input via the YSAS control panel to drive small rudder movements to increase aircraft yaw stability and to maintain rudder trim.

e. Data interfaces comprised of a MIL-STD-1553 multiplex (MUX) data bus and an ARINC-429 serial data bus. The MUX provides for EGI to MDP communications. The ARINC-429 bus transmits INS data to the TCAS and INS backup data to the MFD for Backup Display when the MDP is not operational.

f. Low Voltage Power Supply (LVPS) that converts aircraft DC power to the voltages required to operate the EGI circuits.

EGI DATA OUTPUTS

The EGI provides navigation data (known as the navigation solution) and additional data to the MDP via the MUX bus, and INS data to the TCAS via the serial bus during normal operation. The EGI provides backup data to the MFD for MFD Backup Display construction when the MDP is failed or off via the serial bus. While the EGI computes and transmits backup data to the MFD when the MDP is not operating, the MDP must have first initiated EGI operation. The following data is provided:

EGI MDP navigation data (MUX bus):

- a. Current location in three dimensions: latitude, longitude and altitude.
- b. Angular position, angular velocity and angular acceleration in three axis: pitch, roll, and yaw.
- c. Linear velocity and linear acceleration in three axes: left-right, forward-aft, up-down.
- d. Heading and ground track in true degrees and magnetic degrees along with ground speed.
- e. Range and bearing to the steerpoint in true degrees and magnetic degrees.

EGI MDP additional data (MUX bus):

- a. Computed wind speed and direction based on differences between aircraft heading and ground track.
- b. RALT AGL data.

EGI TCAS processor INS data (serial bus):

- a. Angular position, in three axis: pitch, roll, and yaw.
- b. Heading and ground track in magnetic degrees along with ground speed.

NOTE

RALT AGL data is also provided to the TCAS via the MDP. See IDENTIFICATION FRIEND OR FOE (IFF), TRAFFIC COLLISION AVOIDANCE SYSTEM (TCAS).

EGI MFD backup data (serial bus):

- a. Attitude data.
- b. Magnetic heading.
- c. Steering to the steerpoint (selected before MDP became non-operational).
- d. Lateral and normal acceleration.
- e. Radar altitude.

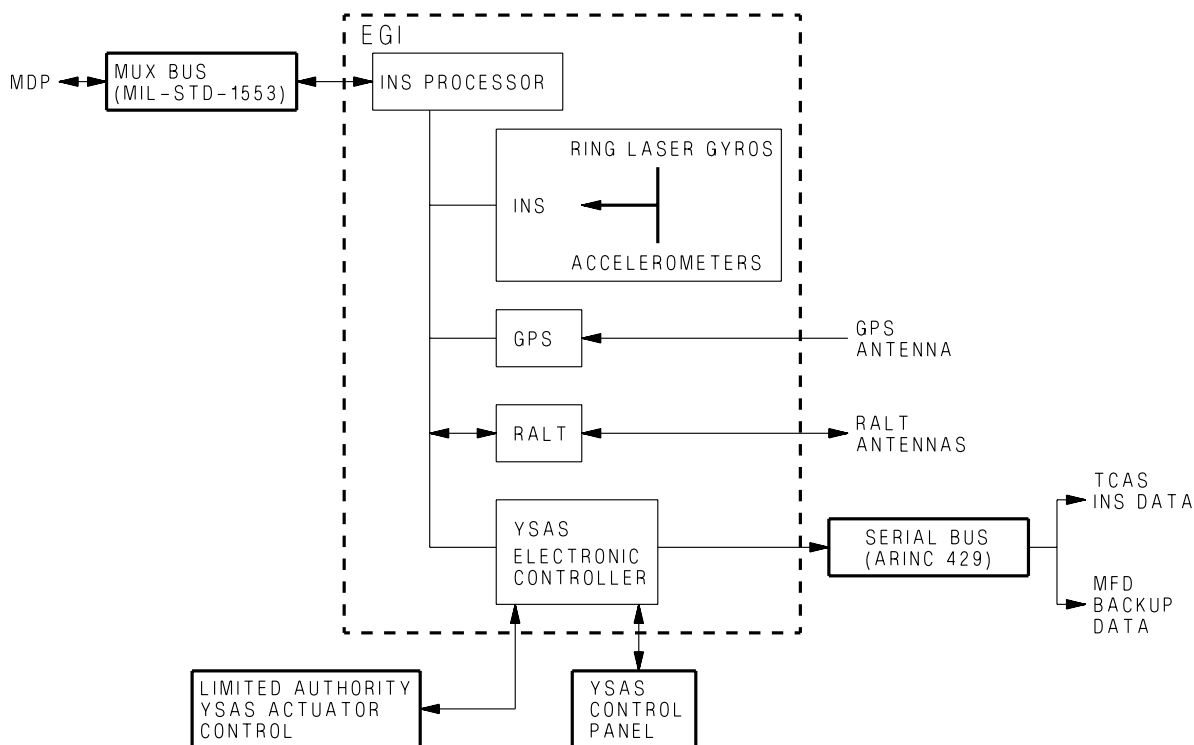

Figure 1-192. EGI System

T38002-376-1-021

The EGI computes three separate navigation solutions, INS ONLY, GPS ONLY, and BLENDED. BLENDED combines, using a Kalman filter, constant Present Position (PP) updates from the GPS ONLY solution with the INS ONLY solution, so long as the PP is within 40,000 meters (21.6 NM or 25 SM) of the current INS ONLY solution. All three solutions are complete, with only one exception; the GPS ONLY solution does not include attitude data. All three navigation solutions are continuously provided to the MDP regardless of Master Mode, the PNS or selected EGI navigation solution.

Inertial Navigation System

The basic principles of inertial navigation measure the effect of forces applied to a body and apply changes in velocity (acceleration/deceleration) to compute changes in location. The process starts with a known location (acquired during alignment) and assesses movement from the initial position to determine current location.

The INS consists of six sensors, three mutually orthogonal digital Ring Laser Gyros (RLG) and three mutually orthogonal accelerometers. Based on a

known initial position, the INS processor, using a Kalman filter, applies linear acceleration supplied by the accelerometers and angular acceleration provided by the RLGs to compute the INS ONLY navigation solution. The Kalman filter also accounts for changes in barometric altitude supplied by the Air Data Computer (ADC) via the MDP.

The INS must be aligned to the aircraft's present attitude and position to function properly prior to employment. The alignment process enables the INS to determine attitude by detecting gravity under static conditions and to initialize the Kalman filter by providing an initial position. Although aircrew can program the current starting position for an alignment in DEST 200 via the UFCP (refer to UFCP FUNCTION KEYS, this section), the INS normally receives stored PP data from the previous mission during the alignment process. Approximately 4 minutes are required to complete the alignment process (assuming an accurate starting point). Refer to ALIGNMENT, this section.

T.O. 1T-38C-1

EGI

In addition to the INS ONLY navigation solution, the INS provides yaw rate to the YSAS. The INS processor also provides a command and control functionality for the EGI by relaying data between the MUX bus or serial bus interfaces and other EGI subsystems.

Global Positioning Receiver

The Rockwell Collins GEM IV global positioning receiver processes specially coded satellite signals to compute an accurate position, velocities and time. This information is processed by the EGI INS processor to provide the GPS ONLY navigation solution and to aid the INS in computing the BLENDED navigation solution. Due to internal clock variations within GPS receivers, four satellite signals are required to determine a three dimensional position. Satellite geometry affects the quality of the computed position. The best GPS solution is obtained when all four satellites line-of-sight spacing are as far apart as possible.

The GPS receiver continually receives signals from all visible satellites and selects the four that can result in the most accurate solution. The quality (accuracy) of the GPS solution is estimated by the GPS receiver based on the satellites being used and is presented as a Figure of Merit (FOM) on the EGI Display Page. The GPS receiver also maintains data from a fifth satellite on standby to replace one of the active satellites information whenever removed from view (line-of-sight lost).

The GPS receiver is a single circuit card located within the EGI system. It is powered via the EGI LVPS and does not interact with either the RALT or YSAS sub-systems (also located within the EGI). The GPS receiver has the capability to process C code data for standard positioning service and P code data for precise positioning service. Receiving and processing P code data requires insertion of a valid crypto key into the GPS receiver.

The continuously downloaded data from the satellite network contains information on the health of each satellite to include location within the network. This information is stored within the EGI and is used during initialization of the GPS receiver. The initial aircraft position is provided by the MDP (stored PP or aircrew UFCP manual entry) and used in conjunction with network satellite location data to enable the GPS receiver to search for close proximity satellites first; resulting in accelerated signal acquisition. The initial Time Of Day (TOD) required to acquire satellites is provided by the battery operated clock within

the EGI. This EGI battery also maintains memory used to store satellite network transmitted dynamic data which includes current GPS satellite locations. Normal satellite acquisition takes 1.5 to 3 minutes to obtain a valid GPS position but can take as long as 45 minutes when stored data is not available.

NOTE

Improper EGI shut down can corrupt EGI stored memory resulting in extended delays during satellite signal acquisition.

Radar Altimeter (RALT)

The Honeywell RALT is a single circuit card located within the EGI system. It is powered by the EGI LVPS and is on (but not necessarily transmitting) whenever the AAP EGI Power Switch is ON. The RALT system is a radio altimeter that uses a transmitted/received RF signal to determine height above ground (not a radar system like those used for weather or weapons employment). The RALT indicates altitudes from 0 to approximately 5200 feet AGL with an accuracy of ± 2 feet or 2%, whichever is greater when within $\pm 45^\circ$ of straight-and-level flight in pitch and roll. RALT data is displayed (within parameters) on the MFD and HUD to a resolution of 10 feet.

During ground operations (aircraft on the ground), the RALT automatically operates in standby mode; the RALT transmitter is disabled and no RALT altitude is displayed on the MFD or HUD. The installation of a WSSP blocks both transmit and receive RALT antennas (rendering the system unreliable) The RALT automatically transitions to standby mode when aircrews select a POD configuration on the MFD WPN Display Page. Refer to MFD MENU AND FUNCTION DISPLAY PAGES, this section. The aircrew can also manually select RALT standby mode in-flight via the UFCP EGI Key Display. Refer to UFCP FUNCTION KEYS, this section. Regardless, when RALT is in standby mode the TCAS commanded mode of RA only results in the TCAS operating in TA.

NOTE

Operations with the WSSP installed and the RALT operating can result in incorrect and potentially misleading RALT data.

The RALT switches automatically to transmit/receive mode when the aircraft is airborne (weight off wheels). Normal transmit/receive mode consists of two sub-modes: Search Mode and Track Mode.

a. Track Mode: The RALT actively tracks ground return signals and provides measured altitude data for HUD and MFD displays.

b. Search Mode: The RALT actively searches for ground return signals with no data provided for HUD/MFD display (HUD and MFD RALT data blanked). The Search Mode occurs when there is insufficient RF signal reflected from the ground or the aircraft pitch and/or roll parameters exceed RALT requirements.

RALT selectable minimum altitude warning is provided when selected by aircrew via the UFCP ALT Key Display. Refer to UFCP FUNCTION KEYS, this section. In addition, when RALT altitude is available, the data is used to compute MARK point elevations. Refer to UFCP FUNCTION KEYS, this section.

The INS processor distributes commands received from the MDP to the RALT card and returns RALT data to the MDP via the MUX bus. It also distributes RALT data to the MFD (to produce the MFD Backup Display when the MDP is non-operational) via the serial bus.

Yaw Stability Augmentation System (YSAS)

The YSAS automatically dampens aircraft short period yaw oscillations resulting in increased stability. The YSAS is comprised of an electronic controller, the YSAS control panel, (see FLT CONTROLS, this section), and a limited authority hydraulic actuator attached to the rudder. The YSAS electronic controller is contained within a single circuit card located within the EGI system. It receives yaw rate data from the INS and impact pressure signal data from the ADC. Impact pressure is a measure of speed

and at higher speeds, the authority of YSAS to move the rudder is reduced. The controller generates an electrical output that drives the YSAS hydraulic actuator mounted within the rudder linkage, subsequently moving the rudder a maximum of $\pm 2^\circ$ in response to the yaw acceleration of the jet. Rudder trim is limited to $\pm 2^\circ$, which is in addition to the 2° maximum response to yaw acceleration. The YSAS can be engaged/disengaged to include rudder trim manual adjustment by the FCP aircrew via the YSAS control panel. Refer to FLIGHT CONTROL SYSTEM, this section.

The YAW DAMPER Switch located on the YSAS control panel must be ON to enable augmentation system and/or rudder trim operation. The YSAS will disengage or will not engage when the following conditions occur:

- a. INS provided yaw rate data or ADC provided impact pressure data become invalid.
- b. Loss of the LEFT 115VAC BUS (generator failure/generator disconnected with no crossover).
- c. Loss of RIGHT ESSENTIAL DC BUS.
- d. The limited authority rudder actuator is not functioning normally (hydraulic pressure low or failed).
- e. Excessive pitot heat on time (approximately 30 seconds) during ground operations.
- f. Loss of MDP.

The rudder trim function does not operate if the YSAS is disengaged.

EGI OPERATION

EGI POWER SWITCH

The EGI Power Switch on the AAP is a two-position switch (ON/OFF) used to signal the EGI power supply as follows:

T.O. 1T-38C-1

EGI

- a. OFF - The EGI, RALT and YSAS are turned off.



The EGI requires at least 10 seconds to properly shut down after turning the EGI Power Switch OFF via the AAP. This allows the EGI to store necessary data used for initial alignment and the BIT results from the current power cycle. Removal or interruption of DC power before the EGI Power Switch has been off for 10 seconds can corrupt the stored data and cause the next EGI alignment to fail completely or be inaccurate.

- b. ON - When turned on, the EGI runs a self test and then transitions to standby mode with all functions disabled. To initiate the alignment process and to activate RALT and YSAS, the MDP must send initiation commands via the MUX Bus. This does not happen until the MDP has completed its start-up function (indicated when the PFR display is presented on the MFD).



If the battery switch is not on, power transients can cause the INS to lose alignment, resulting in loss of all attitude and heading data.

NOTE

If the EGI status is OFF and the AAP EGI Power Switch is ON (MDP start-up function complete), cycle the AAP EGI Power Switch OFF/ON to recover.

EGI HUD AND MFD DISPLAYS

The HUD and MFD provide the following displays/information using EGI data:

- Alignment status.
- FPM (F-16 HUD).
- CDM (MIL-STD HUD).
- Pitch ladder and horizon line.
- Bank angle.
- Aircraft heading.
- Bearing/range to the steerpoint.
- TD Box.
- G load.
- Aircraft GS.
- FD and CDI for EGI navigation.

Refer to HUD and MFD descriptions for details about these display items, this section.

ALIGNMENT

During EGI powerup (aircraft on the ground), the conditions necessary for a Stored Heading (SH) alignment are checked, refer to STORED HEADING ALIGNMENT, this section. If required conditions are met, a SH alignment is initiated. If the conditions for SH alignment are not met, a Gyro Compass (GC) alignment is initiated.

NOTE

- Operation of the EGI in NAV Mode without FULL alignment degrades the performance of the EGI which can result in erroneous indications.
- If an MDP power interruption occurs while the EGI is aligning, DEST 200 coordinates are not displayed on the UFCP or MFD until the EGI transitions to NAV.

After the alignment is successfully completed, the EGI can be switched manually into the NAV Mode or automatically when the aircraft is taxied (moved). If an alignment failure occurs, EGI switches into ATT mode. The type of alignment and operational mode depends on the availability of GPS data and WOW status.

Stored Heading Alignment

Preparation for a SH alignment comprises a complete EGI GC alignment with Satellite reception until FULL is displayed in the HUD Message Window and on the EGI Display Page, followed by turning the AAP EGI Mode Switch OFF, without first selecting NAV. This entire process must be accomplished, without moving the aircraft, to provide and store the data required for a SH alignment.

After the above process has been accomplished, provided the aircraft has not since been moved, turning the EGI Switch ON enables the MDP to command

EGI to conduct a SH alignment. During this phase, WAIT is displayed in the HUD Message Window and on the EGI Display Page. The aircraft should not be moved during the SH alignment. When the SH alignment is complete, if there is no GPS satellite reception, the HUD Message Window displays FULL NO GPS for 3 seconds. At this point, the EGI automatically transfers to NAV Mode and NAV is displayed in the HUD Message Window and on the EGI Display Page, and ALN is replaced by NAV on the UFCP EGI Key Display. A SH alignment should be completed in 1.5 minutes or less and the GPS should receive satellite reception after approximately 1.5 minutes. NAV is removed from the HUD Message Window display after 10 seconds.

Gyro Compass Alignment

When the conditions for SH alignment are not met, the MDP commands GC alignment when the EGI Power Switch is turned ON. This places the EGI system into the course alignment and satellite acquisition process. During this phase, the aircraft should not be moved, WAIT is displayed in the HUD Message Window and the following are displayed on the EGI Display Page:

- a. EGI MODE: GC-ALN.
- b. INS STAT: WAIT.
- c. GPS STAT: ON.

During the alignment process, the EGI INS subsystem is detecting velocities and accelerations generated by gravity and the rotation of the earth. Using this data and present position information, the INS determines attitude and direction. As the processing progresses, the EGI sends the drift rate, the level of INS accuracy (DEGRADED or FULL) and the GPS FOM, related to an expected position error, to the MDP. This data is displayed on the EGI Display Page.

If the aircraft is moved, the EGI system enters ATT Mode; ATT is displayed in the HUD Message Window for 60 seconds and on the EGI Display Page as long as the EGI system is in ATT mode. If the ATT condition is valid for more than 60 seconds, the message is removed from the HUD Message Window and ATT is displayed only in the F-16 HUD EGI data block.

When the Course Alignment is completed (approximately 2 minutes), the EGI system continues with the fine alignment process as follows:

a. DEGRADED is displayed in the HUD Message Window, Figure 1-193, sheet 1 and on the EGI Display Page, Figure 1-193, sheet 2. If the aircraft is moved, the EGI system switches to NAV Mode with INS degraded accuracy (drift of greater than 0.8 NM/hr) and poor navigation performance can be expected.

b. If the aircraft is not moved during Degraded Alignment status, the fine alignment process continues to improve until the EGI system accuracy is 0.8 NM/hr and FULL is displayed in the HUD Message Window and on the EGI Display Page. This process takes approximately 4 minutes.

If alignment is interrupted by selecting NAV via the UFCP EGI Key Display or by moving the aircraft. Selecting ALN after aircraft movement has stopped resumes the EGI alignment process.

The EGI is automatically switched into NAV Mode when the aircraft starts to taxi. The EGI can also be manually switched to NAV Mode by selecting NAV on the UFCP EGI Key Display. Regardless, when the EGI switches to NAV, FULL is removed from the HUD Message Window and EGI Display Page. When the EGI system switches to NAV Mode, PP is stored in the MDP as DEST 200.

If the aircraft is switched to NAV before DEGRADED is displayed in the HUD Message Window and on the EGI Display Page, the EGI system automatically selects ATT Mode.

When DEST 200 has been manually updated prior to or during alignment, the coordinates are used as the PP and sent to both the INS and GPS. If DEST 200 has not been manually updated, the PP is read from the INS portion of the EGI (its location at the last shut down) and transmitted back to the GPS portion of the EGI as the PP. PP is used by the EGI to aid the GPS subsystem in getting its initial satellite acquisition and by the INS system to start its alignment. If GPS data does not become available, the MDP displays DEGRADED NO GPS in the HUD Message Window and NOSAT on the EGI Display Page after the Course Alignment phase of the process is completed. See Figure 1-193, sheet 3. Two common causes of no GPS data are a grossly incorrect PP (more than 200 NM) or GPS antenna obstruction (e.g., aircraft shelter). Aircrew should verify the accuracy of the DEST 200 coordinates by selecting DEST 200 on the UFCP DST Key Display and, if necessary, update the system by editing the DEST 200 coordinates via the

T.O. 1T-38C-1

EGI

UFCP, refer to UFCP FUNCTION KEYS, this section. If the PP coordinates are changed in DEST 200 during the alignment process and prior to GPS reception of satellites, the alignment process is automatically aborted and reinitiated (relying on the new data). If DEST 200 coordinates are not manually updated, the INS ACCR data on the EGI Display Page blinks during the alignment process.

An EGI PP malfunction can occur during the alignment process due to an incorrect DEST 200 entry. As an example, a West longitude can be inadvertently changed to an East longitude. An error can be difficult for aircrew to detect since changes to the PP normally take 10 seconds to display. EGI alignment coordinates should be verified on the EGI Display Page.

NOTE

- If a PP entry error is made during the alignment process, the INS velocities can become inaccurate and/or the GPS may fail to acquire satellites. This condition can be identified by a failed alignment and/or degraded INS navigation performance. Therefore, aircrew must confirm the correct PP is loaded at the start of the alignment process and guard against inadvertent key entries anytime DEST 200 is displayed.
- Except for cases with the GPS antenna obstructed (e.g. aircraft shelter), GPS FOM should be 3 or better. GPS SAT

should be 4. If INS STAT: FULL and GPS STAT: NOSAT are displayed on the EGI Display Page, reenter the DEST 200 coordinates on the UFCP DST Key Display Page, even if DEST 200 and the EGI Display Page show the correct coordinates. If these steps fail to achieve a proper alignment, a more serious INS/GPS problem exists.

- For cases with the GPS antenna obstructed (e.g. aircraft shelter), the above listed items should be checked once clear of the obstruction.

Once the alignment is complete and NAV is selected, DEST 200 coordinates can not be updated. On either HUD format, when the EGI system is switched to NAV Mode, NAV is displayed in the HUD Message Window for 10 seconds.

EGI Course Alignment Displays

Course Alignment data is displayed on both the HUD and MFD as follows:

a. HUD: The FPM (F-16 HUD) and CDM (MIL-STD HUD) are not displayed in the HUD. The pitch ladder is fixed at the Center Field Of View (CFOV), parallel to aircraft wings. The aircraft heading display is the best available system data. Ground speed is not displayed.

b. MFD: The pitch ladder and horizon line are fixed parallel to the aircraft wings. The aircraft heading is best available system data. Ground speed is not displayed.

F-16 HUD
GC-ALIGNMENT, DEGRADED

17:30:59

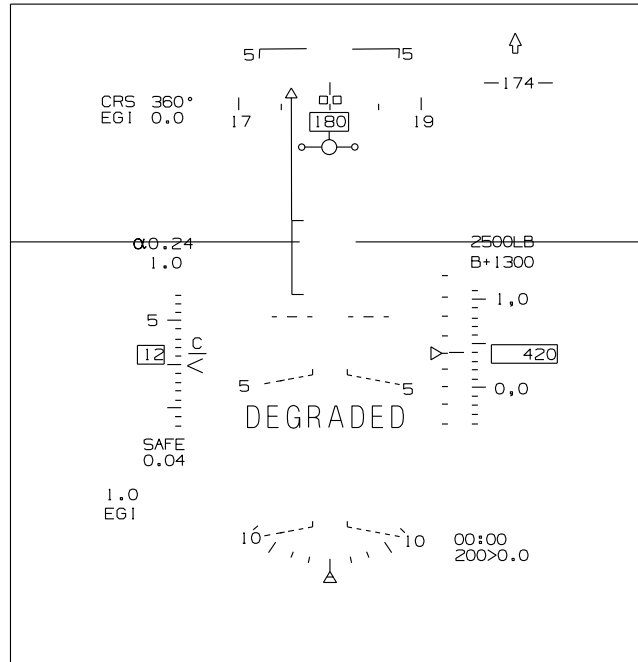

00:00

MIL-STD HUD
GC-ALIGNMENT, DEGRADED

17:30:59

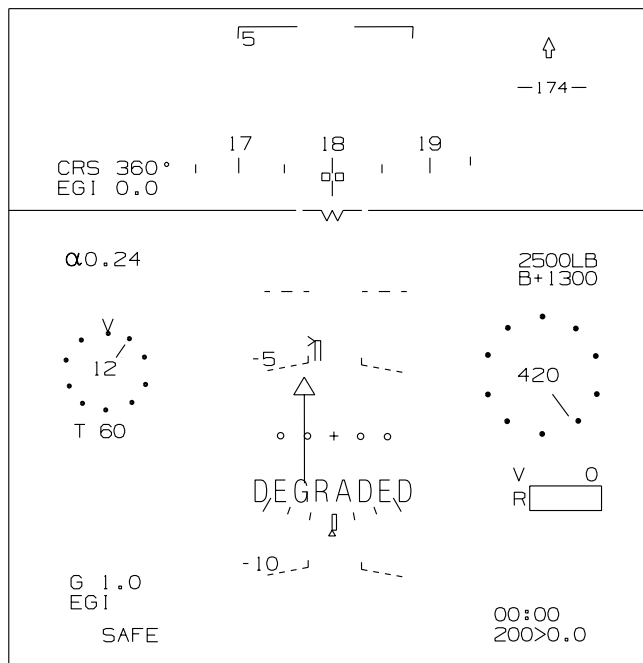

00:00

Figure 1-193. GC Alignment Displays (Sheet 1 of 3)

T38002-377-1-020

GC ALIGNMENT, DEGRADED



Figure 1-193. GC Alignment Displays (Sheet 2)

GC ALIGNMENT, NO SATELLITES



Figure 1-193. GC Alignment Displays (Sheet 3)

T.O. 1T-38C-1

EGI

Continuation and Termination of the Alignment Process

Pressing UR-3 on the UFCP EGI Key Display manually toggles between NAV Mode and INS alignment, Figure 1-194. When the EGI system reaches the Degraded Alignment stage of the GC alignment process, the tilde symbol (~) is displayed next to ALN and UR-3 can be used for manual selection of the NAV Mode.



T38002-379-1-020

Figure 1-194. UFCP EGI Key ALN Display

When the EGI system is in NAV Mode, UR-3 on the UFCP EGI Key Display is used for manual selection of the alignment. The alignment continues from the phase it was in when interrupted by the previous selection on the NAV Mode. If the alignment was designated FULL when entering the NAV Mode, pressing UR-3 returns to the ALN Mode and FULL is displayed in the HUD Message Window and on the EGI Display Page.

If NAV is automatically selected due to aircraft movement, the title in UR-3 of the UFCP EGI Key Display changes from ALN to NAV. If ATT is automatically selected due to aircraft movement during course alignment, the display in UR-3 of the UFCP EGI Key Display changes from ALN to ATT, Figure 1-195. UR-3 can be used to select ALN.

A (~) symbol is displayed adjacent to ALN or NAV when the opposite function is selectable. ALN is



T38002-380-1-020

Figure 1-195. UFCP EGI Key ATT Display

displayed during the process of a SH and the symbol is removed because UR-3 is not functional. Window UR-3 is not displayed and not selectable when the aircraft is airborne. Reselecting ALN following a SH alignment that has transitioned to NAV, starts a GC alignment process from the beginning.

NOTE

After commanding EGI into NAV Mode via the UFCP EGI Key Display, ALN flashes for approximately 3 seconds in Window 3R prior to displaying NAV.

EGI NAVIGATION SOLUTIONS

The EGI has three navigation solutions:

- Blended navigation solution (EGI). The blended solution is the filtered combination of the best INS and GPS data and is the preferred mode of operation.
- INS Only.
- GPS Only.

All EGI navigation solutions are simultaneously available and the desired navigation solution (used by the MDP) can be manually selected by aircrew via the UFCP EGI Display. Refer to UFCP FUNCTION KEYS, this section.

Blended Mode

The EGI produces the best performance of the INS/GPS in accordance with GPS data accuracy for navigation solutions in Blended Mode. The Blended

Mode solution is an estimate of position, attitude, velocity, and time based on a combination of GPS and INS data. The GPS provides continuously updated PP data for the INS (improved INS accuracy during flight) to include in-flight alignment support. Blended Mode is the EGI powerup default and continues to function based on INS data alone when GPS data is not available. If the GPS subsystem fails during a sortie, Blended Mode is still the most accurate of the EGI navigation solutions due to GPS PP data updates prior to GPS subsystem failure.

NOTE

- GPS does not correct errors due to degraded alignment. The alignment errors are carried forward by the EGI system filters in the INS processing. The GPS updates provided to the INS solution are only applied if they fall within what is determined to be reasonable amount (within 40,000 meters or 25 NM). Therefore, a gross error in the initial position input into the INS is not corrected if GPS position is received after full alignment, which is often the case because of the extended time required to obtain a GPS solution when the initial position has a gross error.
- In the case of alignment under a shelter, causing no GPS reception, the position delta between INS and GPS is going to be very small. The INS tracks position as soon as the taxi starts, with a max error of 0.8 NM/HR. Assuming the INS had a good starting position and full alignment, the position should match the GPS position once reception is received.

INS Only Mode

After a complete GC alignment, the INS Only Mode and Blended Mode EGI Navigation Solutions are identical. Over the course of a flight, the INS Only solution drifts at a rate of up to 0.8 NM/HR (GPS PP Blended Mode updates not received/applied). When INS Only Mode is manually selected by aircrew, the PP is independently computed by the INS and may cause a change in PP data (displayed on the EGI Display Page). If GPS data is not available, the EGI system relies on the INS via the Blended Mode conduit and drifts from the last GPS PP. A Blended

Mode solution that has drifted since the last GPS update always has a more accurate navigation solution than the INS Only solution that has drifted for the duration of the flight without correction. Therefore, an INS Only Mode navigation solution should not be selected in lieu of Blended Mode, even in the event of a GPS failure.

GPS Only Mode

When GPS Only Mode is manually selected by aircrew via the UFCP for the EGI navigation solution, the GPS is used for navigation data while the INS provides the best available attitude data, velocity, heading, G data, roll and pitch data.

GPS Only Mode EGI navigation solution may be selected when the following PFL is displayed, INS NAV DEGRADED - GPS OKAY. This PFL indicates that the EGI INS Only Mode and Blended Mode solutions are unreliable (INS and GPS solutions have diverged more than approximately 0.18 NM [enroute and terminal operations] and approximately 0.11 NM [approach operations]) and the GPS only solution can be used. During EGI navigation solution GPS Only Mode operations, the GPS data is only processed every second (1 Hz rate) and ratcheting of display data may occur.

ATTITUDE (ATT) MODE

ATT Mode is an EGI system Mode that provides attitude and heading data only and is selected automatically in either of the following instances:

- a. On the ground - when EGI system senses velocities along its axes before the Course Alignment process is completed (e.g. the aircraft taxies).
- b. During an in-flight alignment - when GPS data is not available. In the case of in-flight alignment, ATT is as far as the alignment can advance without GPS position data.

NOTE

In the early stages of the EGI system in ATT Mode, heading information is not referenced to either true or magnetic scales. The Heading initially indicates 360° (North) and displays aircraft heading changes from that value and is only useful for determining heading changes of a given amount (10°, 20°, 30°, etc.). In later stages of EGI ATT Mode, heading information may become valid.

T.O. 1T-38C-1

EGI

When the EGI is in ATT mode, the following changes occur on the HUD and MFD. See Figure 1-196, and Figure 1-197, sheet 1 thru 3.

HUD		MFD		SYMBOL	PNS
F-16	MIL STD	HSD	PFR		
X	X	X	X	IVV (Arc/Scale and Digital Readout)	All PNS
X	X	X	X	TOT Speed Bug	
TAS	TAS	X	X	GS Digital Readout	
X	X	X	X	Current G	
X	X	X	X	Side Slip	
X	X	X	X	TTG	
X	X	X	X	EGI Range	
X	X	N/A	N/A	TD Box	
X	X	X	X	Flight Directors	
X	X	N/A	N/A	FPM	
N/A	X	N/A	N/A	CDM	
X	X	360	North	HDG Scale and Indicator	
N/A	X	X	X	EGI Bearing Arrow	
N/A	N/A	X	X	Wind Data	
N/A	N/A	X	N/A	Flight Zones	
N/A	N/A	X	N/A	Flight Plan Data	
X	X	N/A	X	CDI and To/From Arrow	EGI
X	X	N/A	N/A	Bearing Arrow/Radial Readout	
X	X	X (NO VDI)	X	VDI and CDI	SCA
N/A	N/A	X	N/A	Base and FIP/FAF displays	

Figure 1-196. EGI SYMBOLOGY IN ATT MODE (Blended or INS Solution)

NOTE

- X = Removed.
- A/A and A/G HUD reticles are not affected.
- Symbols that do not appear on this list remain displayed.
- The Bearing Arrow/Radial Readout is removed from the HUD when EGI is in ATT and EGI is the data source driving the symbol.
- Initially in ATT mode HDG is removed from the HUD. If heading becomes valid, ATT mode may display heading.

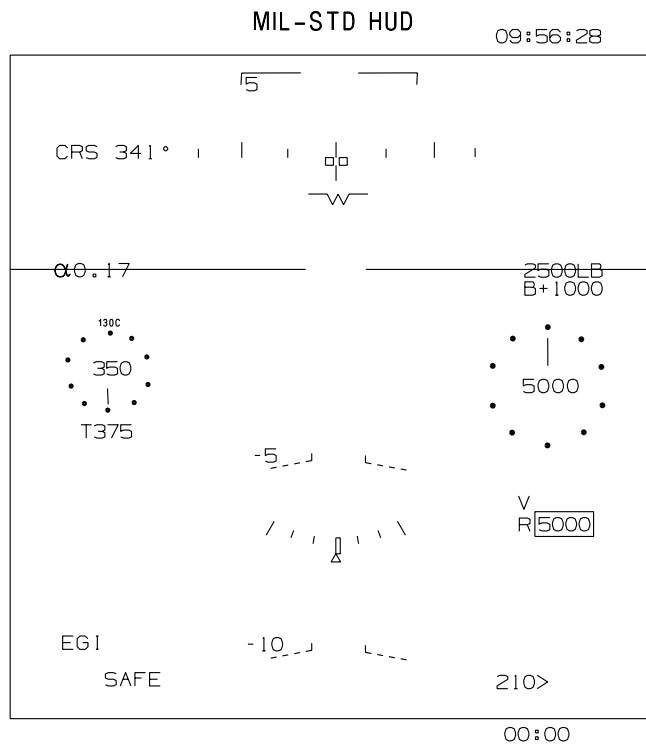
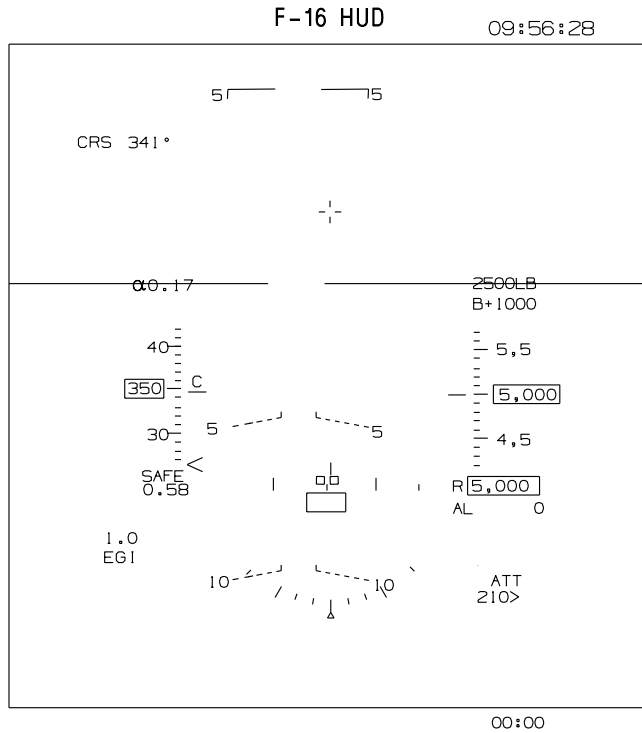

Figure 1-197. EGI ATT Blended Solution Displays (Sheet 1 of 3)

T38002-378-1-020



Figure 1-197. EGI ATT Blended Solution Displays (Sheet 2)

T38002-378-2-020



Figure 1-197. EGI ATT Blended Solution Displays (Sheet 3)

T38002-378-3-020

T.O. 1T-38C-1

EGI

EGI data is used to compute the Divert (DVT) Mode parameters and speed carrots; therefore, DVT is disabled when the EGI system is OFF or in ATT mode. If DVT Mode is selected when the EGI system enters either of these modes (OFF or ATT), it is automatically deselected

If the EGI navigation solution selected is GPS, the following data, normally removed during ATT mode, is displayed (based on the GPS solution validity). See Figure 1-198, sheet 1 thru 3.

- a. IVV (Arc/Scale) and Digital Readout
- b. TOT Speed Bug
- c. TTG
- d. EGI Range
- e. TD Box
- f. GS Digital Readout

The remaining display data is the same as Blended Solution ATT mode.

F-16 HUD

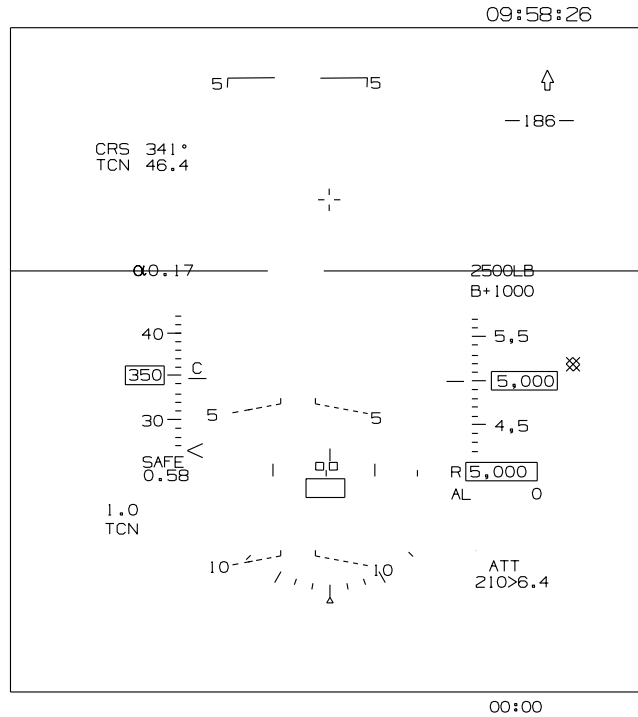

MIL-STD HUD

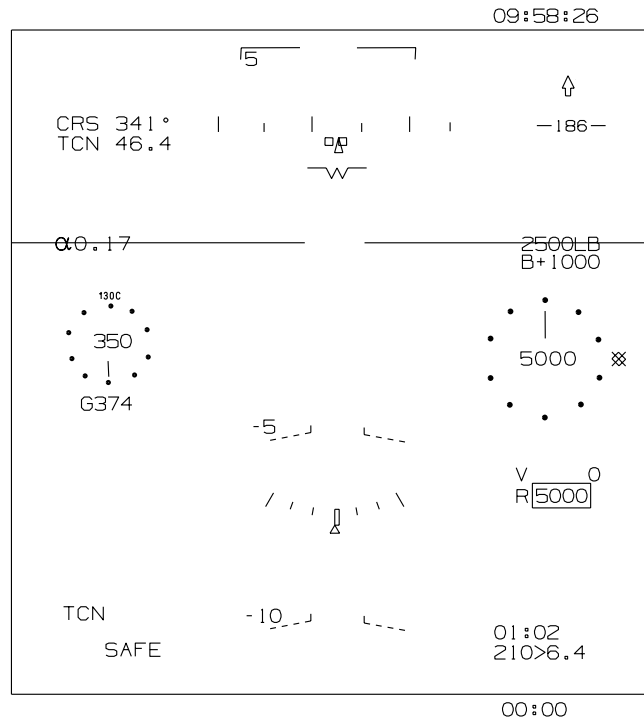

Figure 1-198. EGI ATT-GPS Solution Displays (Sheet 1 of 3)

T38002-381-1-020



Figure 1-198. EGI ATT-GPS Solution Displays (Sheet 2)

T38002-381-2-020



Figure 1-198. EGI ATT-GPS Solution Displays (Sheet 3)

T38002-381-3-021



T38002-382-1-020

Figure 1-199. UFCP Destination (DEST) 200

If the UFCP DST Key Display is selected after MDP powerup but prior to EGI powerup, DEST 200 is displayed with blank coordinates (Window 2 and Window 3). These coordinate windows remain blank during this phase and may be manually entered by aircrew, Figure 1-199. In addition, DS in Window 1 of the UFCP DST Key Display flashes (2 Hz rate) while the EGI system is OFF (regardless of the selected DEST point), to remind aircrew to turn the EGI system ON via the AAP EGI Power Switch. When EGI is initiated by the MDP, the initial EGI system alignment PP coordinates for the alignment process are retrieved from stored EGI system position data at shutdown unless DEST 200 is entered manually by aircrew on the UFCP DST Key Display.

DEST 200 parameters can be changed only when the EGI system is OFF or the EGI system is in the alignment phase and GPS data is not available. If

GPS data is available, the DEST 200 parameters are updated automatically during the alignment process, even if data was previously entered manually by aircrew. Updating DEST 200 coordinates during the alignment process, manually or automatically via GPS, can cause the EGI INS alignment status to return to WAIT while the EGI system conducts a validity check and subsequently restarts the alignment process.

The alignment coordinates of DEST 200 guide the GPS systems acquisition. Entering the correct PP ensures that the alignment process is completed in 4-minutes.

NOTE

If a PP entry error is made during the alignment process, the INS velocities can become inaccurate and/or the GPS may fail to acquire satellites. This condition can be identified by a failed alignment and/or degraded INS navigation performance. Therefore, aircrew must confirm the correct PP is loaded at the start of the alignment process and guard against inadvertent key entries anytime DEST 200 is displayed.

EGI FUNCTION KEY

Refer to UFCP FUNCTION KEYS, this section.

EGI Display Page

The EGI Display Page, Figure 1-200, presents the following operational data:

- a. EGI Mode of operation (MODE: OFF, STBY, SH-ALN, GC-ALN, AIR-ALN, NAV/EGI, NAV/INS, NAV/GPS or ATT).
- b. INS Alignment Status (STAT: WAIT, LEVEL, FULL, DEGRADED, NAV or blank).

c. INS predicted accuracy (ACCR) represented by drift rate (from 0.8 to 8.0 NM/hour) during GC-ALN and by FOM (1-9) based on probable position error in meters during AIR-ALN and NAV:

- (1) Less than or equal to 25
- (2) Greater than 25 up to 50
- (3) Greater than 50 up to 75
- (4) Greater than 75 up to 100
- (5) Greater than 100 up to 200
- (6) Greater than 200 up to 500
- (7) Greater than 500 up to 1000
- (8) Greater than 1000 up to 5000
- (9) Greater than 5000

d. INS alignment time (ALTM: MM:SS).

e. EGI wind [WIND: XXX°/XXX (Direction in Degrees/Velocity in knots)].

f. GPS system status (STAT: ON/OFF).

g. GPS Figure Of Merit (FOM: X=XX-XX), based on probable position error in meters:

- (1) Less than or equal to 25
- (2) Greater than 25 up to 50
- (3) Greater than 50 up to 75
- (4) Greater than 75 up to 100
- (5) Greater than 100 up to 200
- (6) Greater than 200 up to 500
- (7) Greater than 500 up to 1000
- (8) Greater than 1000 up to 5000
- (9) Greater than 5000

h. Number of satellites (SAT: X).

i. Time Of Day (TOD: HH:MM:SS G or T).

j. Present Position (P/P: LAT/LON).

k. Aircraft G (GMAX: +X.XX/ GMIN: -X.XX).



Figure 1-200. GC Alignment Full Display

T38002-383-1-020

Refer to MFD MENU AND FUNCTION PAGES, this section.

EGI INFLIGHT ALIGNMENT (IFA)

When the EGI Power Switch is moved from OFF to ON while airborne, the EGI enters the IFA process.

NOTE

The MDP is required for EGI initialization. If the EGI Power Switch is cycled OFF/ON with a non-operational MDP, the EGI system enters Standby Mode and does not self-initialize.

When the EGI Power Switch is turned on while airborne, the EGI remains in Standby Mode for 10 seconds while LEVEL is displayed in the HUD Message Window. This provides aircrew time to establish level flight conditions before the IFA is initiated. LEVEL remains displayed in the HUD during the IFA. Maintain unaccelerated straight and level flight while LEVEL is displayed in the HUD Message Window.

NOTE

The IFA process fails if the EGI system is subject to external acceleration input caused by maneuvering. In addition, if level flight is not maintained, the alignment results in false readings.

IFA of the INS is similar to an alignment on the ground. The EGI first attempts to detect gravity and determine attitude. Because the EGI system is moving and true straight and level is not attainable, an IFA takes much longer than the 4 minute ground alignment. Due to aircraft EGI system movement in-flight, exactly how much longer an IFA takes is a function of flight conditions with required constant position updates. The required constant PP updates can only be provided by the GPS.



Erroneous attitude indications can be displayed during the EGI IFA process. Consideration should be given to availability of a visible horizon prior to initiating an IFA. If an alignment is required with no visible horizon, refer to standby instruments for attitude and heading information until the alignment is complete.



If a GPS failure occurs, do not cycle the EGI power to regain GPS operation. INS is still available provided EGI power is not cycled. Cycling the EGI Power Switch while in flight will force an Air Align which can not be accomplished without GPS, forcing the EGI into ATT mode. The EGI supplies only attitude and relative heading data in ATT mode and g is not available

NOTE

DEST 200 alignment coordinates are not updated during an IFA, they retain the last ground GC Align coordinates.

When attitude alignment phase is complete, if GPS is receiving satellite signals, the EGI automatically continues with the IFA process. Aircrew can maneuver the aircraft when LEVEL is removed from the HUD Message Window, the pitch ladder is displayed on the HUD, Figure 1-201, sheet 1 and the EADI is displayed on the MFD. The EGI Display Page shows AIR-ALN Mode, Figure 1-201, sheet 2, and the EGI system continues to improve the alignment level and heading accuracy for 5 minutes and then switches to NAV Mode automatically with an EGI Blended Mode Solution. NAV is then displayed in the HUD Message Window for 10 seconds and on the EGI Display Page as the EGI Mode of operation.

T.O. 1T-38C-1

EGI

NOTE

When EGI Mode transitions from AIR-ALN to NAV, the PFL INS NAVIGATION ACCURACY DEGRADED is displayed.

If GPS data is not available after 2 minutes, IFA cannot be completed and EGI NAV Mode is not available. LEVEL remains displayed in the HUD Message Window and ATT is displayed in the right

lower corner of the F-16 HUD only and on the EGI Display Page, as the EGI Mode. When attitude data is valid, LEVEL is removed from the HUD Message Window, the pitch ladder and heading data are displayed on the HUD and the EADI is displayed on the MFD. All other navigation data not valid in ATT Mode is removed from view on the HUD and MFD displays. Refer to ATT Mode, this section.

If the GPS regains satellite reception, the EGI requires a power cycle to reinitiate an IFA.

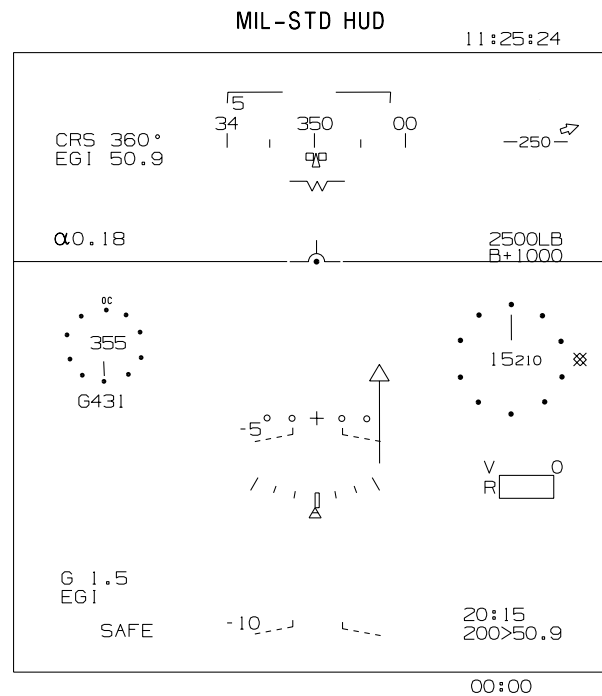
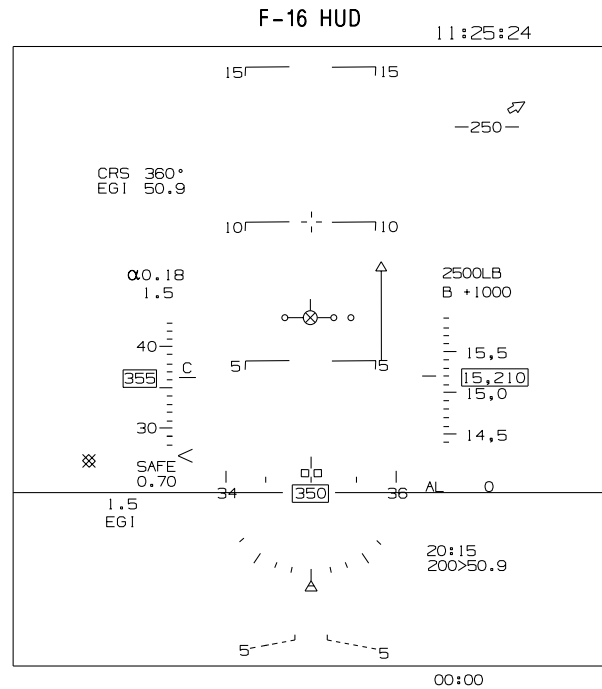

T38002-384-1-020

Figure 1-201. EGI In-Flight Alignment-Air-ALN Displays (Sheet 1 of 2)



Figure 1-201. EGI In-Flight Alignment-Air-ALN Displays (Sheet 2)

EGI OPERATIONS WITH MDP FAILURE

When the MDP fails, the EGI continues to process navigation data; the EGI system also continues to provide steering data to the steerpoint, but the steerpoint cannot be changed. The EGI navigation solution is provided to the MFD via the serial bus to generate the MFD Backup Display. The following data is provided:

- a. Aircraft Heading.
- b. Aircraft Attitude.
- c. Bearing/Range to the last steerpoint.

Only the Blended Mode navigation solution is provided to the MFD during EGI backup operations; this is independent of any mode selections made before

the MDP failure or shut down. PFLs are not displayed for an MDP failure.

NOTE

Do not turn the EGI Power Switch OFF when the MDP has failed. The EGI continues to provide some navigation data. Without the MDP, the EGI cannot be commanded back into NAV Mode.

EGI OFF OR COMPLETELY FAILED OPERATION

When the EGI system is OFF or complete failure occurs, the following display changes occur on the HUD and MFD (PFR / HSD). Refer to Figure 1-202 and Figure 1-203, sheet 1 thru 3.

T.O. 1T-38C-1

EGI

HUD		MFD		SYMBOL	PNS
F-16	MIL STD	HSD	PFR		
X	X	X	X	IVV (Arc/Scale and Digital Readout)	All
X	X	X	X	TOT Speed Bug	
TAS	TAS	N/A	N/A	Airspeed Indicator	
N/A	N/A	X	X	Groundspeed Digital Readout	
X	X	X	X	Current G	
X	X	X	X	Bank/Sideslip Indicator	
X	X	X (No ADI)	X (No ADI)	Horizon Lines	
X	X	X	X	TTG	
X	X	X	X	EGI Range	
X	X	N/A	N/A	TD Box	
X	X	X	X	Flight Directors	
X	X	N/A	N/A	FPM/CDM	
X	X	360	North	HDG Scale and Indicator	
N/A	X	X	X	EGI Bearing Arrow	
N/A	N/A	X	X	Wind Data	
N/A	N/A	X	N/A	Flight Zones	
N/A	N/A	X	N/A	Flight Plan Data	
X	X	N/A	X	CDI & To/From Arrow	EGI
X	X	N/A	N/A	Bearing Arrow/Radial Readout	
X	X	X (No VDI)	X	VDI & CDI	SCA
N/A	N/A	X	N/A	Base & FIP/FAF Displays	

Figure 1-202. Symbology with EGI Off or Completely Failed

NOTE

- X = Removed.
- A/A and A/G HUD reticles not affected.
- Symbols that do not appear on this list remain displayed.
- When EGI complete failure occurs, SUBSYSTEM FAIL, PFL displays.

F-16 HUD

10:02:16

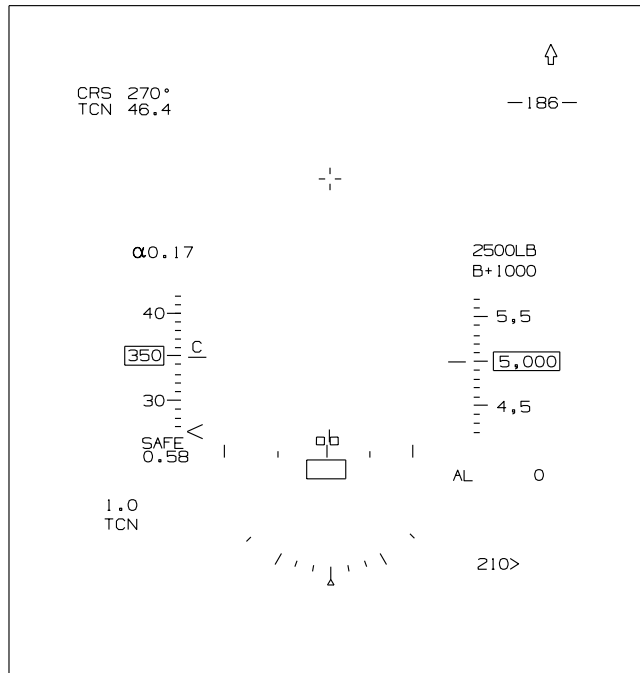

00:00

MIL-STD HUD

10:02:16

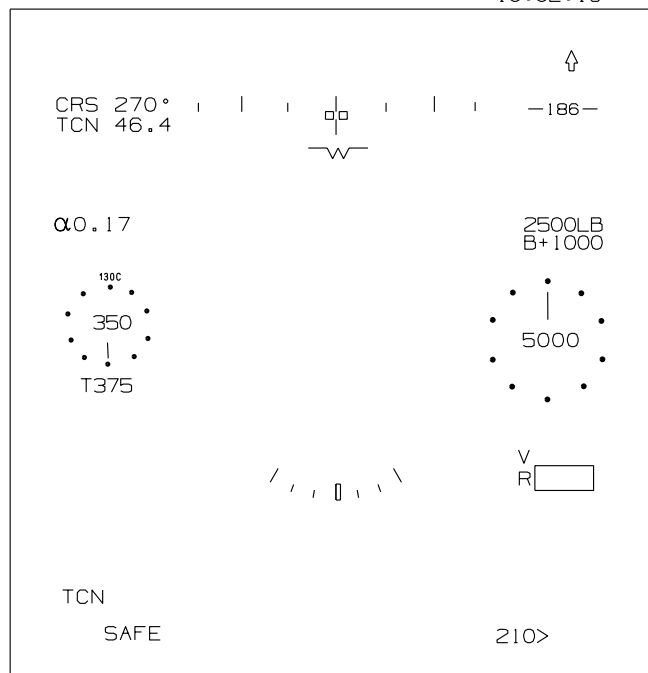

00:00

Figure 1-203. EGI Off or Completely Failed Displays (Sheet 1 of 3)

T38002-385-1-020



Figure 1-203. EGI Off or Completely Failed Displays (Sheet 2)

T38002-385-2-020



Figure 1-203. EGI Off or Completely Failed Displays (Sheet 3)

T38002-385-3-020

T.O. 1T-38C-1

EGI

EGI WITH GPS FAILED

After GPS failure, the Blended Solution will be updated based solely on INS inputs. INS attitude information is not affected by the loss of GPS and navigation information is only slightly degraded (drift rate of up to 0.8 NM per hour). Without GPS availability, the system cannot accomplish an inflight alignment. If the aircrew attempts an inflight alignment without GPS, the EGI can only operate in ATT Mode. When GPS failure occurs, GPS FAILURE, PFL opens.

EGI WITH INS FAILED

During an INS failure, the following changes occur on the HUD and MFD (HSD/PFR). Refer to Figure 1-204, and Figure 1-205, sheet 1 thru 3. Some of the data is automatically provided by the GPS Only navigation solution; however, the previously selected navigation solution remains selected on the UFCP EGI Key Display. When INS failure occurs, INERTIAL REFERENCE FAILURE - NAV AND ATT NOT RELIABLE, PFL opens.

HUD		MFD		SYMBOL	PNS
F-16	MIL STD	HSD	PFR		
X	X	X	X	IVV (Arc/Scale and Digital Readout)	All PNS
X	X	X	X	TOT Speed Bug	
GS is GPS	GS is GPS	GS is GPS	GS is GPS	Airspeed Indicator	
GPS	GPS	GPS	GPS	Groundspeed Digital Readout	
X	X	X	X	Current G	
X	X	X	X	Side Slip/Bank Indicator	
X	X	X (No ADI)	X (No ADI)	Horizon Lines	
X	X	X	X	TTG	
GPS	GPS	GPS	GPS	EGI Range	
X	X	N/A	N/A	TD Box	
X	X	X	X	Flight Directors	
X	X	N/A	N/A	FPM/CDM	
GPS Ground Track	GPS Ground Track	U	U	HDG Scale and Indicator	
N/A	N/A	X	X	Wind Data	
GPS Ground Track Based	GPS Ground Track Based	GPS Ground Track Based	GPS Ground Track Based	CDI & To/From Arrow	
X	X	X (No VDI)	X	VDI	
N/A	N/A	X	N/A	Base & FIP/FAF Displays	

Figure 1-204. EGI Symbology with INS Failed

NOTE

- X = Removed.
- A/A and A/G HUD reticles not affected.
- Symbols that do not appear on this list remain displayed.
- U = Unreliable.

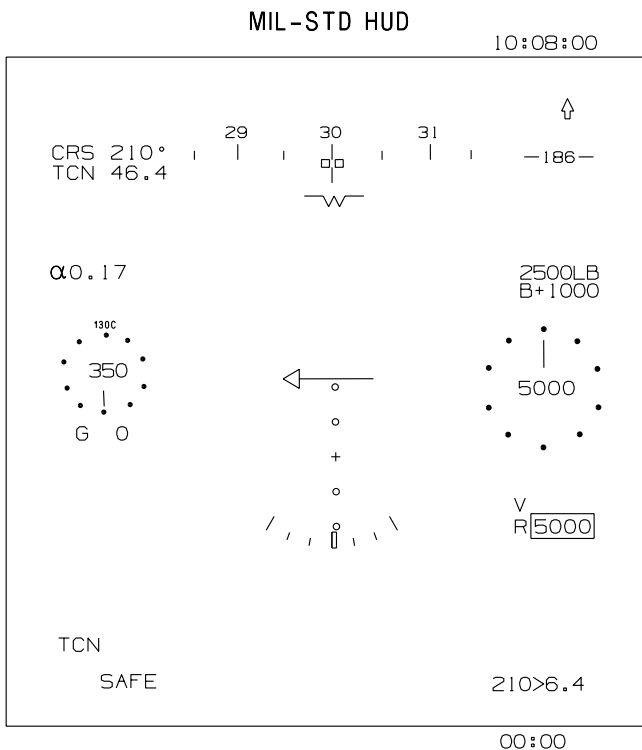
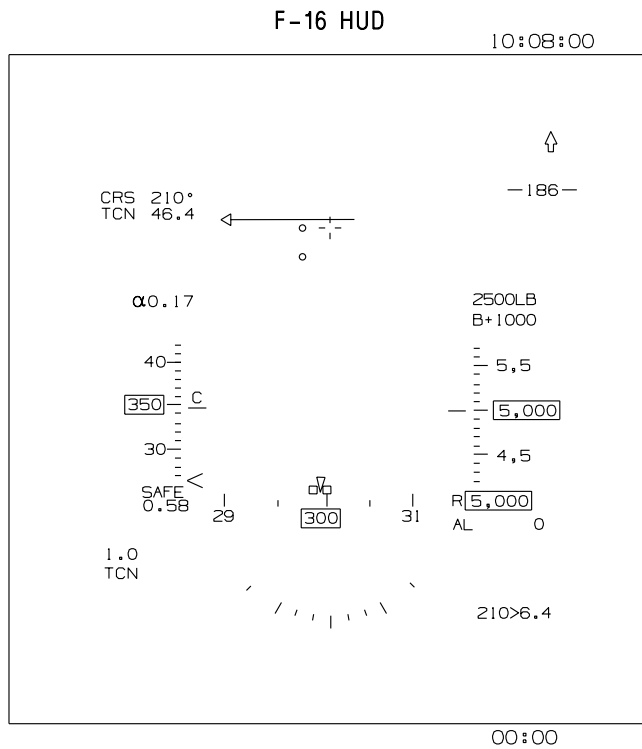

Figure 1-205. EGI with INS Failure Displays (Sheet 1 of 3)

T38002-386-1-021



Figure 1-205. EGI with INS Failure Display (Sheet 2)

T38002-386-2-021



Figure 1-205. EGI with INS Failure Display (Sheet 3)

T38002-386-3-021

NAVIGATION OVERVIEW

The NAV Master Mode enables navigation between points. This mode is designed to provide the aircrew with the necessary navigation aids for accurate and efficient performance during all mission phases. Navigation is accomplished using the following:

- a. EGI
- b. VOR/DME
- c. ILS/DME
- d. TACAN

Control of the navigation function is accomplished primarily via the UFCP, with some controls on the MFD. Backup radio control panels provide independent control of the TACAN/DME and VOR/ILS navigation receivers if the MDP or UFCP fails. Refer to **BACKUP CONTROL PANELS**, this section. Navigation information is displayed on the UFCP, HUD, and MFD. Refer to **UFCP**, **HUD** and **MFD** descriptions for details about navigation display items, this section.

Navigation computations are continuously executed by the MDP, regardless of the selected master mode. All navigation data is provided on the MFD regardless of master mode selection, however, only the NAV Master Mode provides the pilot with the complete navigation data on the HUD.

The NAV Master Mode is selected by any of the following:

- a. Automatically at MDP powerup - default.
- b. Pressing the Control Stick MMS downward.
- c. Pressing MR-5 on the PFR or HSD displays.

The NAV Master Mode is exited when any other master mode is selected.

NAVIGATION CONTROLS

The following are the primary controls used to program and operate the T-38C navigation system:

- a. A mission planning system is used to preprogram data (radio frequencies, flight plans, PPA (NAVAID or SCA), declutter options, etc.).
- b. Data Transfer System (DTS): used to transfer preplanned mission data to the aircraft (replaces MDP previously stored data). Most navigation data

can also be manipulated by aircrew via the UFCP or MFD. Refer to **DATA TRANSFER SYSTEM (DTS)**, this section.

c. Avionics Activation Panel (AAP): controls power to the MDP, EGI and TCAS and allows switching between normal and backup operations.

d. Audio Control Panel (ACP): allows aircrew station identification of TACAN, VOR/ILS, DME, and marker beacon.

e. Up Front Control Panel (UFCP): primary aircrew control for frequency and EGI destination selection, which also allows navigation and flight plan database management.

f. Multifunctional Display (MFD): primary aircrew navigation source selection.

g. NAV B/U and TACAN B/U Control Panels: allow aircrew to select ILS, VOR, or TACAN frequencies for navigation in the event of MDP or UFCP failure; can also be manually selected if desired via the AAP rotary switch. Refer to **BACKUP CONTROL PANELS**, this section.

NAVIGATION DISPLAYS

The following are the primary displays for presentation of navigation data:

a. HUD: displays a variety of navigation source information and raw data/flight director information for the selected PNS. Refer to **HEAD-UP DISPLAY (HUD)**, this section.

b. MFD: primary source of navigation displays, available sources, and all raw data/flight director information. Refer to **MULTIFUNCTIONAL DISPLAY (MFD)**, this section.

c. UFCP: displays EGI steerpoint, navigation source, VOR/ILS/TCN/ILS DME frequencies/channels, FPL information, and FD mode. Refer to **UP FRONT CONTROL PANEL (UFCP)**, this section.

EGI NAVIGATION DEFINITIONS

The EGI navigation database stores destination points, flight plan way points, ICAO points and nearest airports points.

STEERPOINT

The steerpoint is the waypoint, DEST point, or ICAO point currently selected for EGI navigation. The

steerpoint is shown on the UFCP Basic Menu Display (window 1R), the MFD NAV Data Block, and the HUD EGI Data Block. The EGI bearing pointer and range/time data is calculated/displayed based on the steerpoint.

The following designated data points are used for navigation.

DESTINATION (DEST) POINT

A DEST point is geographically defined by the MSL elevation and either latitude/longitude or Military Grid Reference System (MGRS) coordinate. DEST points are part of the navigation data base (assigned identification numbers 200 to 610), which can be selected for waypoints and/or the steerpoint. Destination points can be mission planned and loaded via the DTS or manually entered in the cockpit via the UFCP DST Key Display.

MGRS coordinates are definable by up to eight digits (easting and northing) for both Universal Transverse Mercator (UTM) and Universal Polar Stereographic (UPS) Systems. Refer to UFCP DST FUNCTION KEY, this section.

FLIGHT PLAN WAYPOINT

A waypoint is one of up to 15 DEST and/or ICAO points from the navigation data base that comprise a flight plan.

ICAO POINTS

The EGI navigation data base includes Continental United States (CONUS) ICAO points identified by two to five alphanumeric characters plus a group letter (N, W, or A for Navaid, Waypoint, or Airport). Airports are stored by FAA ID and ICAO code.

The ICAO code, group letter, latitude, longitude, and elevation are stored in the EGI navigation database for each ICAO point. The ICAO expiration date is also stored.

NOTE

Airport ICAO points include elevation while most other ICAO points do not.

ICAO data is loaded into the MDP via the DTS. Following an error free data transfer from the DTS cartridge, if the ICAO expiration date displayed on the MFD is not updated, cycle power to the MDP and

recheck the ICAO expiration date displayed on the MFD Load-To-MDP Display Page to make sure the MDP date matches the DTD date. MFD, HUD and UFCP displays are frozen for approximately 80 seconds at the start of ICAO loading. DEST 200 is automatically selected as the steerpoint during ICAO loading. Refer to DATA TRANSFER SYSTEM (DTS), this section.

An ICAO point can be selected as the steerpoint via the UFCP Basic Menu Display. ICAO points can also be added to a flight plan via the UFCP FPL Key Display. Refer to UP FRONT CONTROL PANEL (UFCP), this section.

ICAO data can be viewed on the ICAO Display Page. BACK, NEXT, and alphanumeric input are provided to navigate through the ICAO data. When an ICAO point is selected as the steerpoint via the UFCP, the ICAO Display Page updates to show the selected ICAO steerpoint at the top of the page. Refer to MFD MENU AND FUNCTION DISPLAY PAGES, this section.

NEAREST AIRPORTS DATABASE

NOTE

The NEAREST AIRPORTS functionality is available only when mission planning data is provided from JMPS.

The Nearest Airports database is created with the mission planning system and loaded to the MDP via the DTS as part of the ICAO data. The Nearest Airports data contains a maximum of 1600 records. The following DAFIF parameters are included for each airport:

- a. Airport Code - ICAO Code or FAA ID if the ICAO Code is not unique.
- b. Airport Name - Truncated after 35 characters.
- c. Latitude.
- d. Longitude.
- e. Runway IDs for longest runway \geq 6000 feet.
- f. Longest runway length.
- g. Runway IDs for second longest runway.
- h. Second longest runway length.
- i. First NAVAID Type, Freq and Channel.
- j. Second NAVAID Type, Freq and Channel.
- k. VHF Tower Freq.
- l. UHF Tower Freq.

T.O. 1T-38C-1
NAV

Refer to GPS/INS BASED NAVIGATION, this section.

FLIGHT PLANS (FPL)

Each FPL is a collection of DEST and/or ICAO points that reside in the navigation data base which is the navigation route and associated time schedule used for navigation. The FPL provides aircrew the ability to follow a predefined navigation route; use of the associated HUD and MFD steering and speed commands provides aircrew on-time arrival control. Flight plans can be loaded via the DTS or manually entered by aircrew via the UFCP FPL Key Display.

Up to 10 FPLs (numbered 0 thru 9) can be defined and stored in the navigation data base; each FPL can consist of up to 15 waypoints (numbered 1 thru 15). The FPL route is defined by the waypoints, with every two sequential waypoints defining a leg of the route. The FPL time schedule is defined by assigning a TOT to any one or all of the waypoints. FPLs are displayed on the HSD lower screen and HUD as follows:

- a. Lines (colored white) are generated on the HSD (within the range selected) connecting the waypoints to represent the various legs of the FPL.
- b. All FD Displays provide steering commands along the route of flight for each leg of the FPL.
- c. Speed commands are provided on the HUD and MFD for arrival on time over any or all waypoints as designated by the aircrew.

NAVIGATION SOURCE

PRIMARY NAVIGATION SOURCE (PNS)

The T-38C has two types of navigation sources, aircraft based (EGI) and ground based (VOR/ILS/LOC/BC, and TACAN). The PNS can be selected on the MFD or UFCP (parallel functionality).

- a. MFD PNS selection is conducted via MOSBs MT-2 thru MT-6, Figure 1-206.
- b. UFCP PNS selection is conducted via the UFCP NAV Source Sub-Menu Display UL-1 thru UL-4, UR-2 and UR-3, Figure 1-207.

Whenever a navigation source is selected, the previously selected source is automatically deselected. There is only one source selected at one time in all avionics master modes.

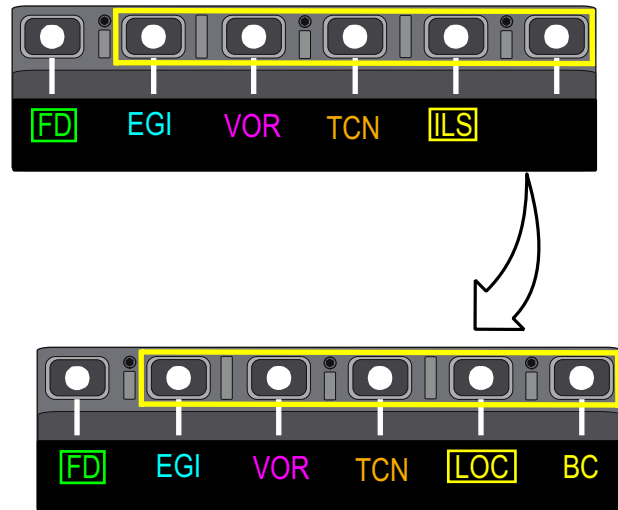

Figure 1-206. MOSBs MT-2 thru MT-6 T38002-391-1-020



Figure 1-207. UFCP NAV Source Sub-Menu Display T38002-392-1-020

EGI As The PNS

When selected, all course information (raw data and FD) is referenced to the EGI steerpoint. FD default mode is OFF (can be manually selected by the aircrew). The CDI and Course Select Window (CSW) are

colored cyan and the EGI range data block is boxed on the PFR and HSD Displays.

The phase of flight, EGI (enroute as default), EGI TRM or EGI APR, is indicated in the lower left corner of the HUD. For all phases of flight, the EGI is exercising Receiver Autonomous Integrity Monitoring (RAIM), which is an internal check for integrity of the GPS. The pilot is notified if RAIM is unavailable or if integrity check fails via PFLs. RAIM PFLs are inhibited for bank angles of 38° or greater and pitch angles of 25° or greater. The transition to terminal mode occurs automatically when navigating a flight plan and the aircraft is within 30 NM of a waypoint with the steering type APT. Non-precision approach mode and a predictive RAIM request are automatically selected when the steerpoint has a steering type of FAF, the aircraft's range to the FAF is less than 4 NM and the aircraft's range to the APT is less than 30 NM. Predictive RAIM verifies satellite availability during the non-precision approach using the FAF and MIS steerpoints. There is no pilot action required and the pilot is only notified by a PFL if the predicted PRAIM check results for the approach are negative.

VOR As The PNS

When selected, all course information (raw data and FD) is referenced to the selected VOR station. FD default mode is OFF (can be manually selected by aircrew). The CDI, CSW, and VOR/ILS range data block are colored magenta and the VOR range data block (prefix V) is boxed on the PFR and HSD Displays.

TACAN As The PNS

When selected, all course information (raw data and FD) is referenced to the selected TACAN station. FD default mode is OFF (can be manually selected by aircrew). The CDI and CSW are colored orange and the TCN range data block (prefix T) is boxed on the PFR and HSD Displays.

ILS As The PNS

When selected, all course information (raw data and FD) is referenced to the selected ILS station; the associated DME (paired or TCN) channel is displayed on the UFCP NAVAID Sub-Menu Display and the NAV Data Block on the PFR and HSD displays. FD default mode is ON and provides both pitch and bank steering commands (can be manually deselected by aircrew). The CDI, CSW, and VOR/ILS range data block are colored yellow and the ILS range

data block (prefix I) is boxed with the VDI display (GS dots colored yellow with the glide path pointer white) presented on the PFR and HSD Displays.

LOC As The PNS

When selected, all course information (raw data and FD) is referenced to the selected ILS station; the associated DME (paired or TCN) channel is displayed on the UFCP NAVAID Sub-Menu Display. FD default mode is ON with bank steering commands only (can be manually deselected by aircrew). The CDI, CSW, and VOR/ILS range data block are colored yellow and the LOC range data block (prefix I) is boxed with the VDI display (raw data only) presented on the PFR and HSD Displays.

BC As The PNS

When selected, the system invokes localizer back course steering logic, allowing the FD to give proper steering commands (course intercept 180° off the selected front course). FD default mode is ON (can be manually deselected by aircrew). The VDI is not displayed and the CDI is directional only with the front course as the selected course. The CDI, CSW, and BC range data block are colored yellow and the BC range data block (prefix I) is boxed (VDI not displayed in this mode) on the PFR and HSD Displays.

SCA As The PNS

When selected, the system activates SCA displays with FIP mode as the default. FD default mode is ON (can be manually deselected by aircrew). The CDI, CSW, and EGI range data block are colored cyan and the SCA range data block (prefix E) is boxed with the VDI display (GS dots colored cyan with the glide path pointer white) presented on the PFR and HSD Displays.

SECONDARY NAVIGATION SOURCE

The secondary navigation sources are the remaining sources not currently selected as primary. The secondary sources for each PNS are summarized in the table below:

T.O. 1T-38C-1
NAV

Primary Navigation Source	Secondary Navigation Sources
EGI	TCN and VOR
TCN	EGI and VOR
VOR	EGI and TCN
ILS	EGI and TCN
LOC	EGI and TCN
BC	EGI and TCN
SCA	TCN and VOR

PRIMARY EGI SOURCE

The Primary EGI Source is determined by the type of point selected as the steerpoint.

a. If the steerpoint is a waypoint (Figure 1-208), the controls and displays act according to the rules associated with FLIGHT PLAN NAVIGATION.



Figure 1-208. UFCP Steerpoint (WAYPOINT)

b. If the steerpoint is a DEST or ICAO point (Figure 1-209), the controls and displays act according to the rules associated with NAVIGATION TO A STEERPOINT.

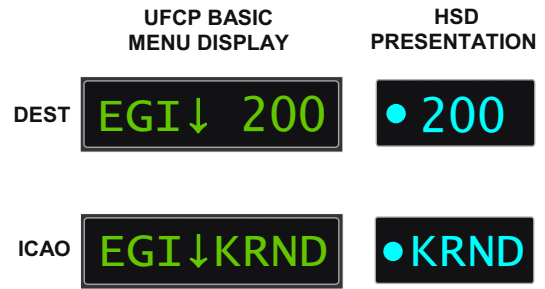

Figure 1-209. UFCP Steerpoint (DEST/ICAO)
T38002-390-2-020

NAVIGATION DATA LOADING

Navigation data can be loaded via the DTS or manually entered by aircrew via the UFCP. The following navigation data can be loaded via the DTS; refer to DATA TRANSFER SYSTEM (DTS), this section:

- a. Preprogrammed flight plans.
- b. Preprogrammed approach data.
- c. Preprogrammed destination points.
- d. ICAO points and nearest airport data.
- e. Preprogrammed flight (Training/No-Fly) zones.

The following navigation data can be manually entered and/or updated by aircrew via the UFCP:

- a. Flight plans.
- b. Destination points except as noted below.

The following navigation data cannot be updated by aircrew via the UFCP:

- a. Destination points 400-499 and 500-509.
- b. Flight plan title, number, and description.
- c. Preprogrammed approach data.
- d. ICAO points and nearest airport data.
- e. Preprogrammed flight (Training/No-Fly) zones.

NAVIGATION CONTROLS AND DISPLAYS

The controls and displays used for navigation are located on both the UFCP and the MFD (Figure 1-210 and Figure 1-211). These devices have parallel functionality to control navigation functions and display navigation information efficiently. Refer to UP FRONT CONTROL PANEL (UFCP) and MULTI-FUNCTIONAL DISPLAY (MFD), this section, for description and functionality.

UFCP NAVIGATION CONTROLS AND DISPLAYS

UFCP Basic Menu Display

The UFCP Basic Menu Display is the only means of selecting the EGI steerpoint, the primary means of displaying the current NAVAID frequency, and the primary means of selecting/displaying UHF/VHF frequencies and channels.

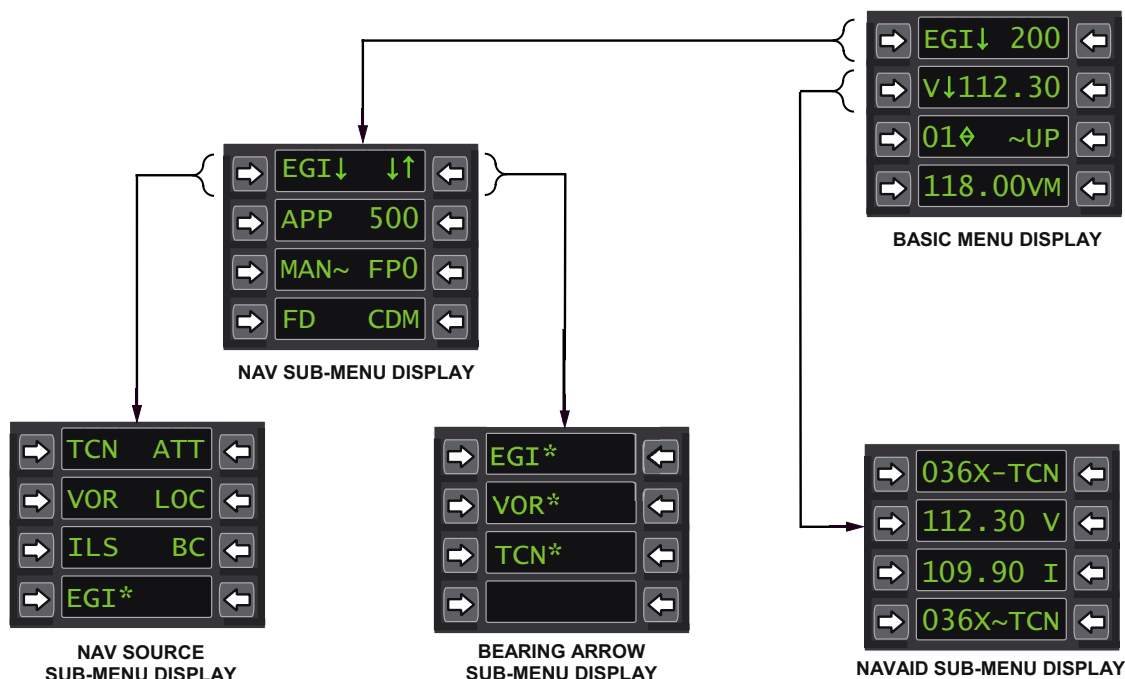

T38002-389-1-020

Figure 1-210. UFCP Basic Menu/Sub-Menu Displays

NAV Sub-Menu Display

The NAV Sub-Menu Display is used for the following functions:

- Selecting the NAV Source Sub-Menu Display.
- Downloading preprogrammed approach (PPA) data for the destination shown.
- Selecting FPL waypoint switching mode (automatic or manual).
- Turning the FD function ON/OFF.
- Selecting the Bearing Arrow Sub-Menu Display.
- Selecting the desired PPA destination.
- Selecting the desired FPL.
- Selecting the CDM display on the EADI.

NAV Source Sub-Menu Display

The NAV Source Sub-Menu Display is used to select the PNS (TCN, VOR, ILS, EGI, LOC, BC, or SCA) and to activate/deactivate AAT. An asterisk indicates the current selection. When a new selection is made, the UFCP reverts back to the NAV Sub-Menu Display.

T.O. 1T-38C-1

NAV

NAVAID Sub-Menu Display

The NAVAID Sub-Menu Display is used for the following functions:

- a. Changing TACAN A/G and A/A channel (X/Y included).
- b. Changing the VOR frequency.
- c. Changing the ILS frequency.
- d. Changing the ILS DME channel (paired or TACAN).

Bearing Arrow Sub-Menu Display

The Bearing Arrow Sub-Menu Display is used to select/deselect the secondary navigation source bearing arrows and ranges to be displayed. The PNS cannot be deselected. All navigation sources default to selected at powerup. An asterisk following the source (EGI/VOR/TCN) indicates that it is selected.

MFD NAVIGATION CONTROLS AND DISPLAYS

The following MFD database displays are selectable from the MENU Display:

- a. FPL Display.
- b. DEST Display.
- c. ICAO Display.
- d. TRAINING ZONES/NO-FLY ZONES Display.
- e. NEAREST AIRPORTS Display.

When either of the FPL, DEST, or ICAO options are selected on the MFD, the default display is that which contains the current selection on the UFCP. When ZONES is selected, the default display is always TRAINING ZONES. The NEAREST AIRPORTS Display is based on current aircraft position.

When one of these displays is selected, data can be reviewed without changing the steering. When data is changed via the UFCP, corresponding MFD changes occur.

FPL DISPLAY

Flight plan data is divided into 10 pages (one FPL per page). Refer to MFD MENU AND FUNCTION DISPLAY PAGES, this section, for format and data content.

FPL data can only be reviewed by aircrew. The UFCP must be used to change data via the FPL Key Display and DEST Key Display.

DEST DISPLAY

Destination data is displayed in numerical sequence. Refer to MFD MENU AND FUNCTION DISPLAY PAGES, this section, for format and data content.

DEST data can be viewed by aircrew on the MFD. The UFCP must be used to change data via the DEST Key Display.

ICAO DISPLAY

ICAO data is displayed in alphabetical order; if numbers are included, they come after the last alphabetic character. Refer to MFD MENU AND FUNCTION DISPLAY PAGES, this section, for format and data content.

ICAO data cannot be modified by aircrew and is viewed on the ICAO Display Page.

TRAINING ZONES/NO-FLY ZONES DISPLAY

This display provides aircrew the ability to select/deselect Training and No-Fly Zones for display on the HSD. Refer to MFD MENU AND FUNCTION DISPLAY PAGES, this section, for format and data content.

NEAREST AIRPORTS DISPLAY

The NEAREST AIRPORTS Display lists the 10 airports nearest to the current aircraft position with minimum runway length (6,000, 7,000, or 8,000 feet) selected by aircrew. Aircrew selection of an airport makes it the steerpoint and activates the divert mode. Refer to MFD MENU AND FUNCTION DISPLAY PAGES, this section, for format, data content and airport selection.

NOTE

The NEAREST AIRPORTS functionality is available only when mission planning data is provided from JMPS.

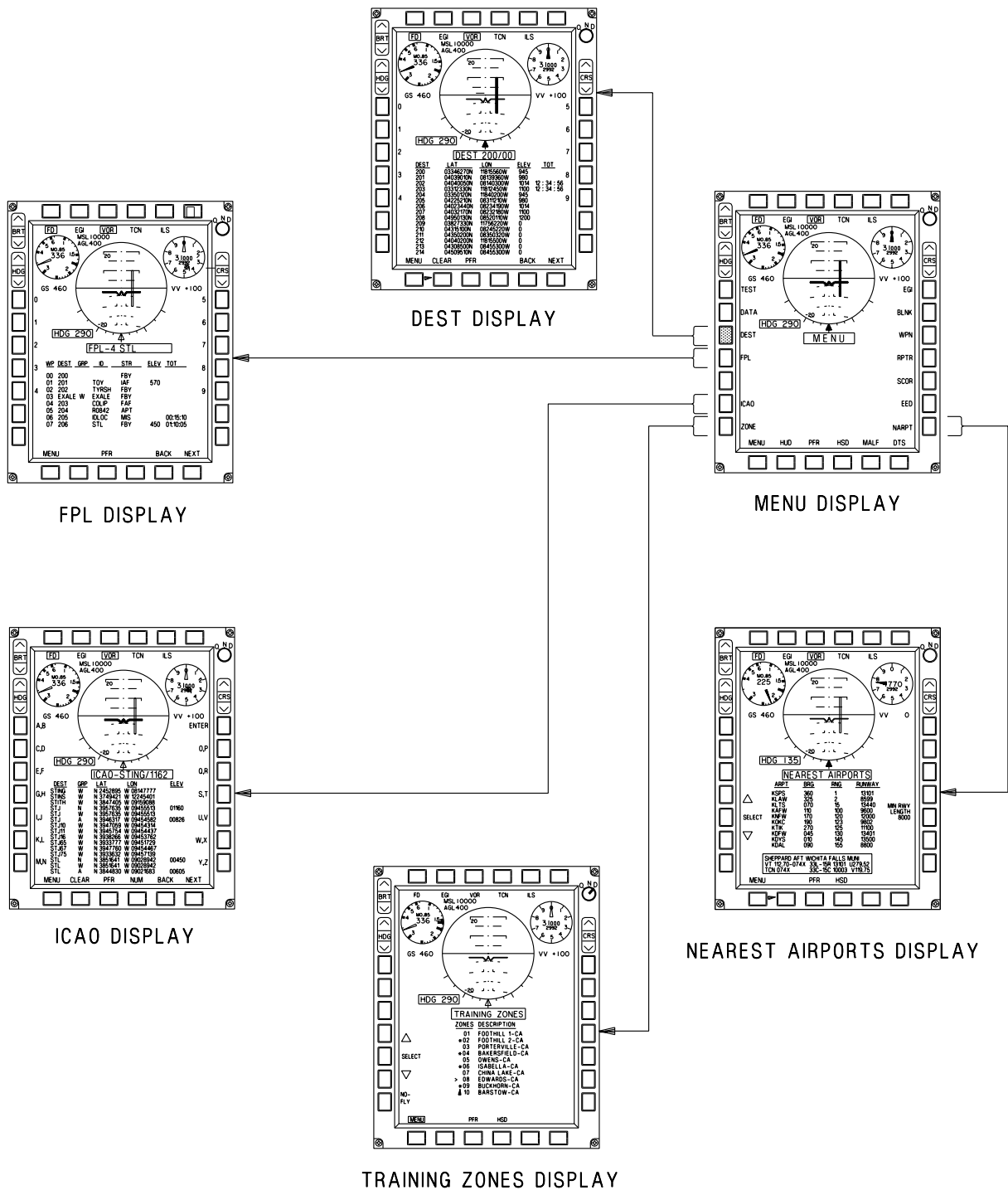

Figure 1-211. MFD Navigation Controls and Displays

T.O. 1T-38C-1

NAV

FLIGHT DIRECTOR LOGIC AND USAGE

The FD provides roll and pitch commands to the selected course and glideslope based on the selected navigation source. The FD is displayed on the HUD (F-16 and MIL-STD) and EADI when selected via the MFD or UFCP. Refer to UP FRONT CONTROL PANEL (UFCP) and MULTIFUNCTIONAL DISPLAY (MFD), this section, for description and functionality.

The HUD displays FD non-precision approach and enroute bank steering symbols, Figure 1-212 (Sheet 1 of 2), and precision approach bank and pitch symbols, Figure 1-212 (Sheet 2), as follows:

Bank (only) steering symbols:

- a. F-16 emulation is a circle shape (CDI is displayed regardless of FD selection).
- b. MIL-STD is a vertical line (CDI is displayed regardless of FD selection).

Bank and pitch steering symbols:

- a. F-16 emulation is a circle with a vertical tic mark for bank and pitch. VDI and CDI are displayed regardless of FD selection.
- b. MIL-STD bank and pitch steering symbols are a vertical line for bank and a horizontal line for pitch. VDI and CDI are displayed regardless of FD selection.

BANK STEERING

FD bank steering (for any PNS except SCA) provides steering to the selected course in the following three phases:

- a. Intercept.
- b. Turn-In.
- c. On-Course.

NOTE

- FD bank steering can command excessive or erroneous steering indications when the aircraft is not on or near the localizer course with ILS or LOC selected as the PNS.

- FD bank steering commands excessive or erroneous steering indications when the aircraft approaches TACAN, VOR, or VORTAC station passage.

Intercept Phase

In the intercept phase, the FD directs an intercept angle 90° (based on ground track) to the selected course. When flying an intercept heading less than 90° , the FD bank steering is deflected from center (up to full-scale) on the same side as the CDI.

Turn-In Phase

The turn-in phase is initiated when the turn-in lead point is reached. At intercept angles equal to or greater than 30° , a maximum bank of 35° is commanded. This lead point is the computed point at which a turn must be initiated based on current flight and wind conditions (and assuming a nominal response time) in order to intercept the selected course.

NOTE

- During aggressive intercepts (high speed, high angle, close range), the bank command sweeps to center in as little as 1 second. However, once centered, the commanded roll rate is 6.5° per second.
- The lead point is continuously computed based on current airspeed, wind, intercept angle and range to station. In ILS/LOC/BC, range to station is always estimated based on the deviation rate of change. Also, range to station is based on radial rate of change in VOR/TCN when DME ranging is not available.

When the turn-in lead point is reached, the FD bank steering centers. If the aircraft is flown in such a manner as to keep the FD bank steering centered, the aircraft will intercept the selected course. The correct amount of bank is maintained during roll in, turn, and rollout by keeping the FD bank steering centered.

NOTE

The maximum bank angle commanded by FD bank steering is 35° .

On-Course Phase

After rollout onto the selected course, the FD provides steering commands to remain on course. Steering commands are wind-corrected such that ground track is maintained on course.

PITCH STEERING

Flight director pitch steering provides commands proportional to the required pitch correction. Pitch steering is available when FD is selected and ILS is the selected PNS with valid glideslope (GS) and LOC data from the ILS receiver. It is also available when SCA is the PNS in FNL submode.

For ILS, pitch steering commands are provided upon initial reception of the GS signal. Pitch steering

commands are provided to maintain a GS intercept angle appropriate for the current GS deviation; as deviation decreases the commanded GS intercept angle decreases. Instantaneous pitch corrections are limited to between 5° up and 7° down.

The FD, like the CDI and VDI, has a natural tendency to become more sensitive at closer ranges. The FD pitch steering algorithm attempts to partially counteract this effect by adjusting sensitivity based on groundspeed. The pitch steering command is stabilized using GS deviation rate and vertical acceleration feedback. ILS/DME ranging has no effect on ILS pitch steering commands.

NON-PRECISION APPROACH AND ENROUTE DISPLAYS

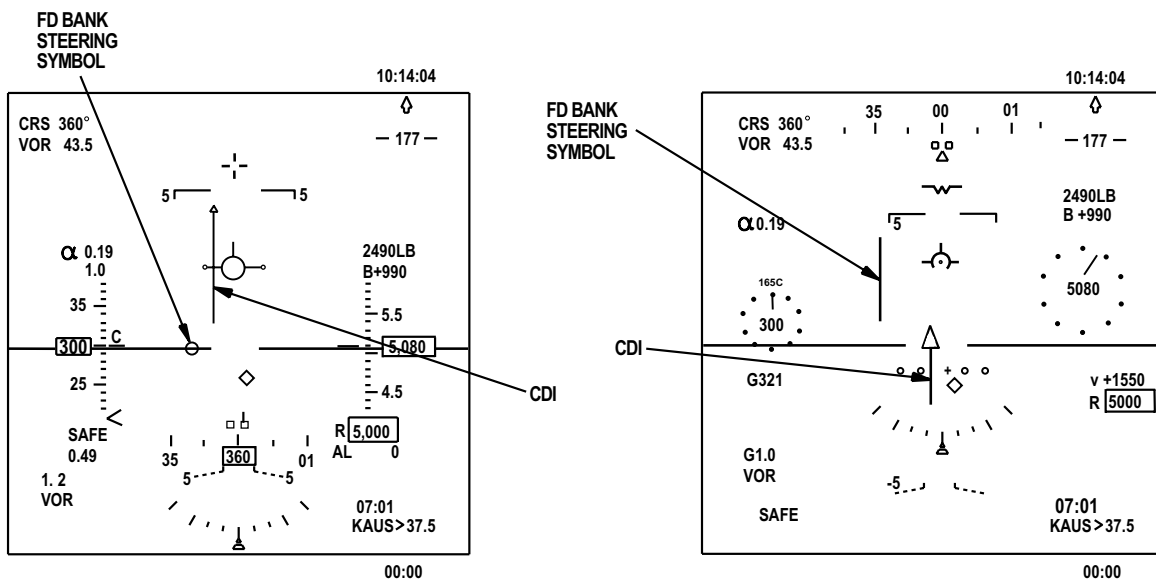

F-16 HUD VOR W/FD

MIL-STD HUD VOR W/FD



PFR VOR W/FD

Figure 1-212. Flight Director Displays (Sheet 1 of 2)

T38002-388-1-020

PRECISION APPROACH DISPLAYS

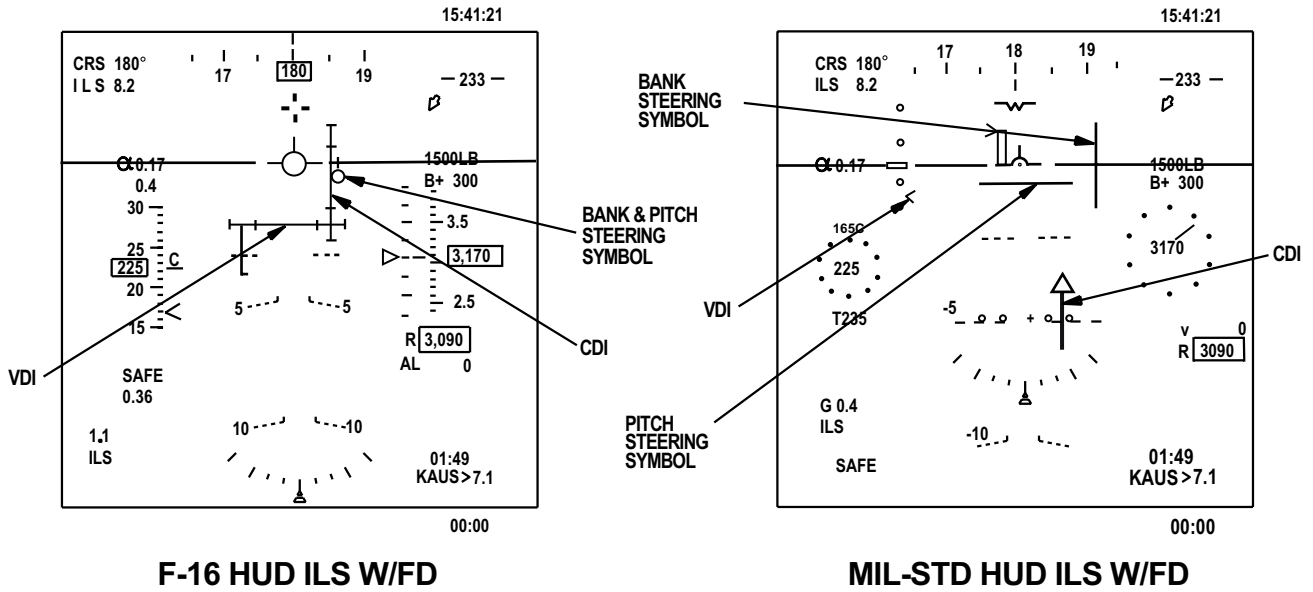

Figure 1-212. Flight Director Displays (Sheet 2)

T38002-388-2-020

GPS/INS BASED NAVIGATION

DESTINATION DATABASE MANAGEMENT

The destination database is managed using the mission planning system to generate the initial database, which is then loaded into the MDP through the DTS prior to flight. The destination database is comprised of the destination and ICAO points. The ICAO points are updated on a regular schedule; the aircrew cannot edit any of the ICAO data.

The aircrew assign the remainder of the destination data through the mission planning system or in the aircraft. After the aircrew have loaded the data, the MFD displays two dates on the LOAD TO MDP Display Page, the current MDP data expiration date and the Data Transfer System (DTS) data expiration date. Refer to DATA TRANSFER SYSTEM (DTS), this section.

DESTINATION POINT DEFINITIONS

Destination points are numbered and defined as shown below:

DEST Points	Primary Use	Program at MPS	Add/Change in Aircraft
200	EGI Start Point	No	Yes, only if EGI OFF or GPS Data N/A
201-350	Flight Plans	Yes	Yes
351-399	User Defined	Yes	Yes
400-499	User Defined	Yes	No
500-509	PPA	Yes	No
510-599	Future Growth	No	No
600-604	A/G Targets	No	Yes (including TD function, refer to T.O. 1T-38C-34-1-1)
605-610	Mark Points	No	Yes (using MARK function)

DESTINATION (DST) FUNCTION KEY

Pressing the DST Function Key on the UFCP selects the UFCP DST Key Display. This display is used to change the coordinates (in LAT/LON or MGRS format) and elevation of DEST points. The default selection display is the steerpoint, displayed as the three-digit counterpart if it is a waypoint. If an ICAO point is the steerpoint, DEST 200 is displayed. Refer to UFCP FUNCTION KEYS, this section.

EMERGENCY DIVERT MODE

The Emergency Divert Mode provides the aircrew critical information on the MFD and HUD in any of the following profiles:

- a. Divert (DVT)
- b. Range (RNG)
- c. Endurance (ENDR)

When activated through the UFCP TOT Sub-Menu or NEAREST AIRPORTS Display Page, the Emergency Divert Mode Display Block replaces the clock and chronometer displays on the MFD lower left corner in all master modes and all PNSs. Refer to MFD NAV AND COMM DATA, this section. Commanded airspeed and altitude indications are displayed on the HUD and MFD.



Emergency Divert Mode calculations do not account for terrain restrictions, engine performance limitations or FAA restrictions.

NOTE

- The Emergency Divert Mode is inoperative and is not selectable until the engine type is selected on the DATA Display Page. A flashing DVT on the UFCP TOT Sub-Menu Display indicates that an engine type has not been selected.
- If the engine(s) are operated in AB, the actual fuel consumption will be significantly greater than calculated.

Divert (DVT) Profile

DVT Profile, Figure 1-213, sheets 1, 2, and 3 computes fuel remaining over the steerpoint, climb and cruise airspeeds and cruise altitude to arrive at the steerpoint using the least amount of fuel based on the following:

- Two engine performance (standard day)
- Aircrew selected aircraft configuration, CLEAN or POD (Weapon System Support Pod [WSSP]).
- Engine type (PMP or NO_PMP)
- Current A/C gross weight
- Current A/C altitude
- Range to steerpoint
- Wind
- Temperature



- Failure to select the correct engine type and aircraft configuration (CLEAN/POD) results in erroneous DVT Profile solutions.
- The DVT Profile cannot account for diversions with gear and/or flaps extended.

NOTE

Selecting DVT makes current altitude, fuel weight, and range to the steerpoint the initial conditions for determining DVT parameters. Deselecting and subsequently reselecting DVT or changing the steerpoint resets these parameters to the altitude, fuel weight, and range to the steerpoint at the moment of activation.

The computations use data from the following charts in T.O. 1T-38C-1-1, Appendices A and B:

- MIL THRUST CLIMB (UNRESTRICTED).
- CONSTANT ALTITUDE CRUISE.
- MAX RANGE DESCENT IDLE THRUST 240 KCAS.

The DVT Profile algorithm computes profiles from sea level up to FL 400 in 5000 foot increments for a total of nine profiles. The profile resulting in the most fuel remaining over the steerpoint is selected for display. The fuel used in each profile is determined by adding the fuel used in the climb, cruise and descent phase for each increment.

Climb Phase calculations start at the current aircraft altitude and computes solutions in 5000 foot increments up to FL 400 using the MIL thrust unrestricted climb charts. In each increment, the fuel burn and ground distance traveled are calculated. From the charts, a temperature correction is applied to the standard day fuel burn and distance traveled. The MDP applies a wind correction to the ground distance traveled during climb.

NOTE

The algorithm does not account for the fuel used to accelerate to climb speed at the start of the divert. However, the DST FUEL indication is updated during acceleration.

Cruise phase calculations are derived from the following equation:

$$\text{Cruise distance} = \text{EGI distance} - \text{climb distance} - \text{descent distance}$$

The EGI distance is the distance to the steerpoint when there is no active FPL. When a FPL is active,

T.O. 1T-38C-1 GPS/INS

divert parameters are based on range to the steerpoint plus the cumulative distance of the remaining legs in the FPL.

The specific range found in the CONSTANT ALTITUDE CRUISE charts is scaled for wind effects. The fuel burn is the cruise distance divided by the wind scaled specific range:

Fuel = distance / wind scaled specific range

The specific range is dependent on altitude and gross weight. The profile step altitude is used for altitude. The aircraft gross weight is based on the system-computed fuel weight at beginning and end of the cruise phase.

Descend Phase Calculations - The Descend Phase begins at the recommended cruise altitude and extends down to sea level in 5000 foot increments. The descent fuel and ground distance covered are calculated for each increment in the descent using the MAXIMUM RANGE DESCENT (IDLE THRUST 240 KCAS) charts.

NOTE

There are no descent fuel or distance corrections for wind or temperature.

The DVT Profile is mechanized with the assumptions that aircrew will:

- a. Climb to the recommended altitude at commanded speed.
- b. Cruise until DESCEND is commanded.
- c. Descend per command.

DVT Profile information is updated 20 times per second to account for changes in actual altitude, airspeed, fuel remaining, wind and temperature. During execution, the altitude of the optimal profile can change from the initial solution; however, the new calculated optimal profile altitude is only to be displayed if it results in a fuel improvement of at least 50 pounds. The following parameters are displayed, as appropriate, on the MFD and on both HUDs, see Figure 1-213 (Sheets 1, 2, and 3):

- a. DST FUEL - The estimated fuel remaining over the steerpoint is based on the recommended profile. Although the projection is continually adjusted based

on current conditions, the estimated fuel remaining assumes strict compliance with commanded optimum profile. DST FUEL is adjusted for nonstandard temperature and winds. Negative values are displayed in red. DST FUEL is only displayed in the MFD Emergency Divert Mode Display Block.

b. CLM - Commanded climb airspeed. This airspeed should be used when climbing to the recommended altitude. CLM is adjusted for nonstandard temperature. CLM is displayed on the airspeed indicator on the MFD and HUD and in the Emergency Divert Mode Display Block during the climb phase.

c. CRZ - Commanded airspeed to achieve maximum range for cruising at the current altitude. CRZ is corrected for nonstandard temperature and winds. CRZ is displayed on the HUD airspeed indicator and in the Emergency Divert Mode Display Block during climb and cruise phases. CRZ is also displayed on the MFD airspeed indicator during the cruise phase. When in the descent phase of the divert profile, the CRZ label changes to DES on the MFD and HUD airspeed indicators while the Emergency Divert Mode Display Block displays the descend speed next to the CRZ label.

NOTE

CLM and CRZ markers are not displayed if they are beyond the tape range on the F-16 HUD.

d. ALT - Recommended divert or best range altitude. For any given divert range, the DVT profile can command a climb from sea level to as high as FL 400. ALT is displayed on the HUD altitude indicator and in the Emergency Divert Mode Display Block. During the descent phase, ALT is removed from both HUDs and DESND replaces ALT on the MIL-STD HUD and the Emergency Divert Mode Display Block. A DESCEND caution flashes for 10 seconds in the HUD and MFD message windows at the start of the descent phase. During descent, the cruise airspeed is 240 KCAS and the climb airspeed is blank.

NOTE

During descent, if the aircraft is flown below the descent profile, the system commands a climb. If this occurs, the pilot should level off until DESCEND is re-commanded.

**DIVERT PROFILE
CLIMB PHASE**

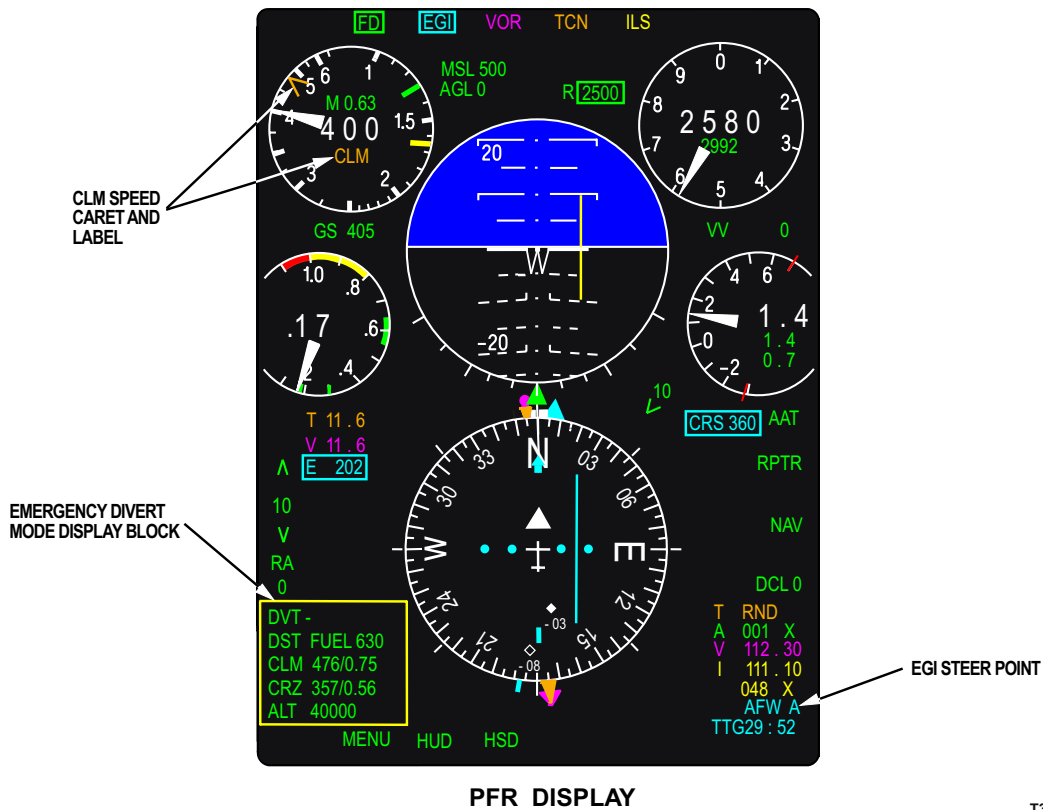
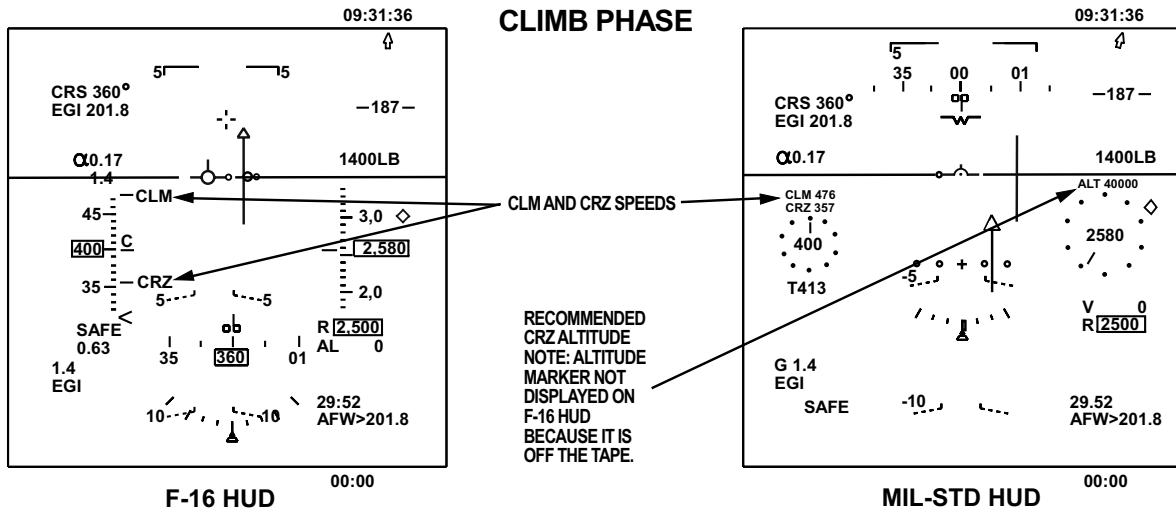

Figure 1-213. Emergency Divert Mode Displays (Sheet 1 of 5)

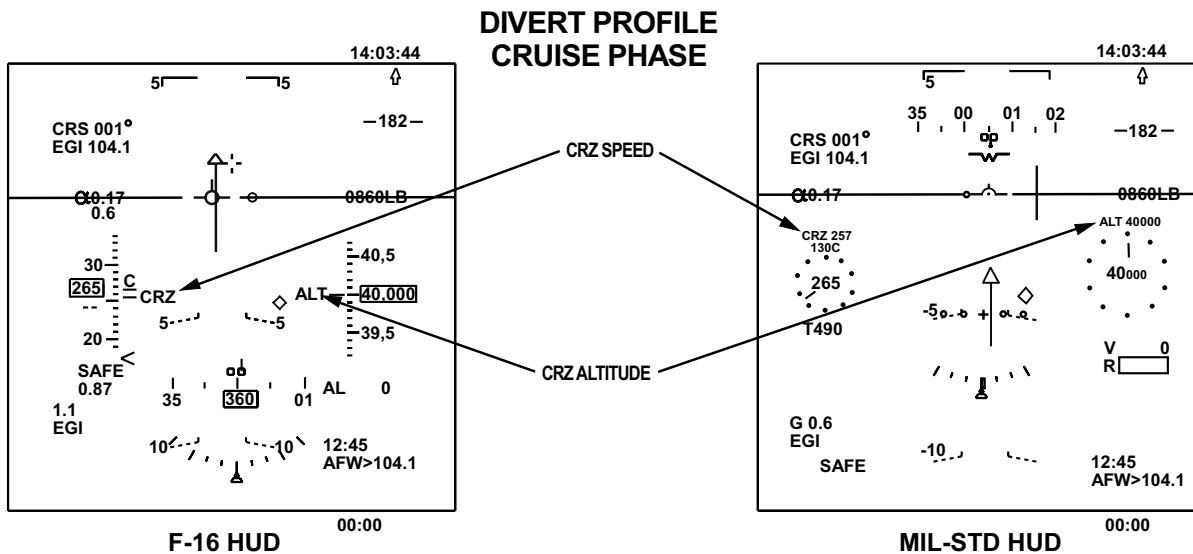
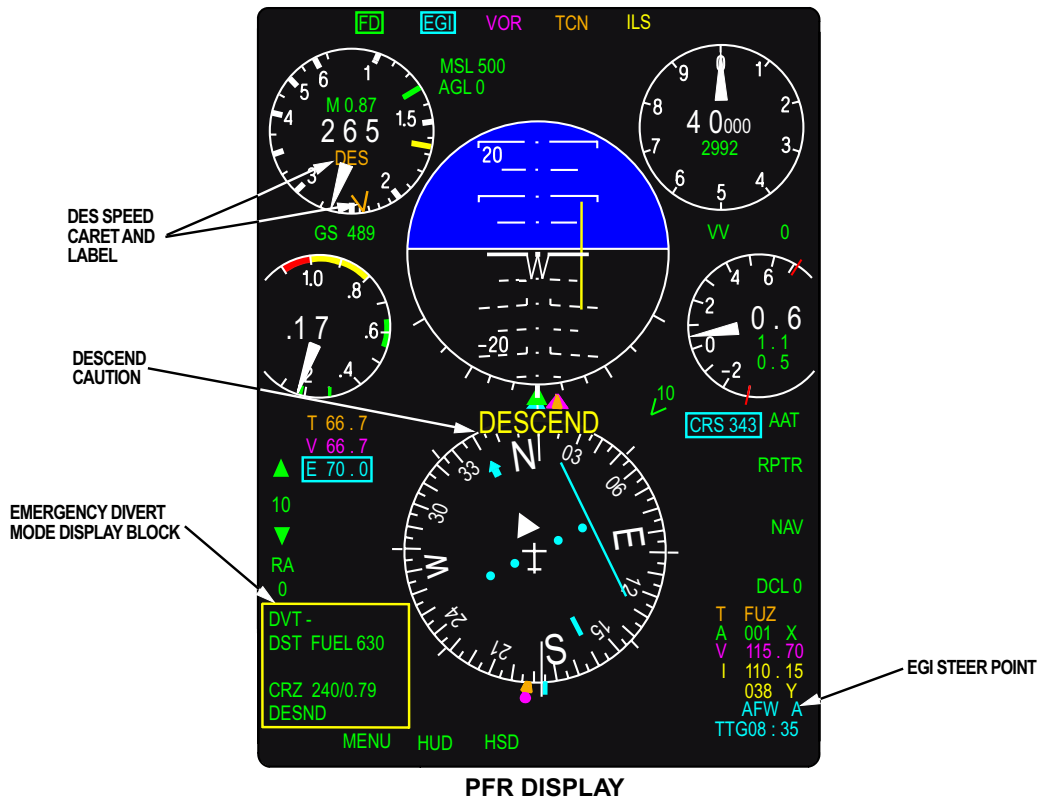
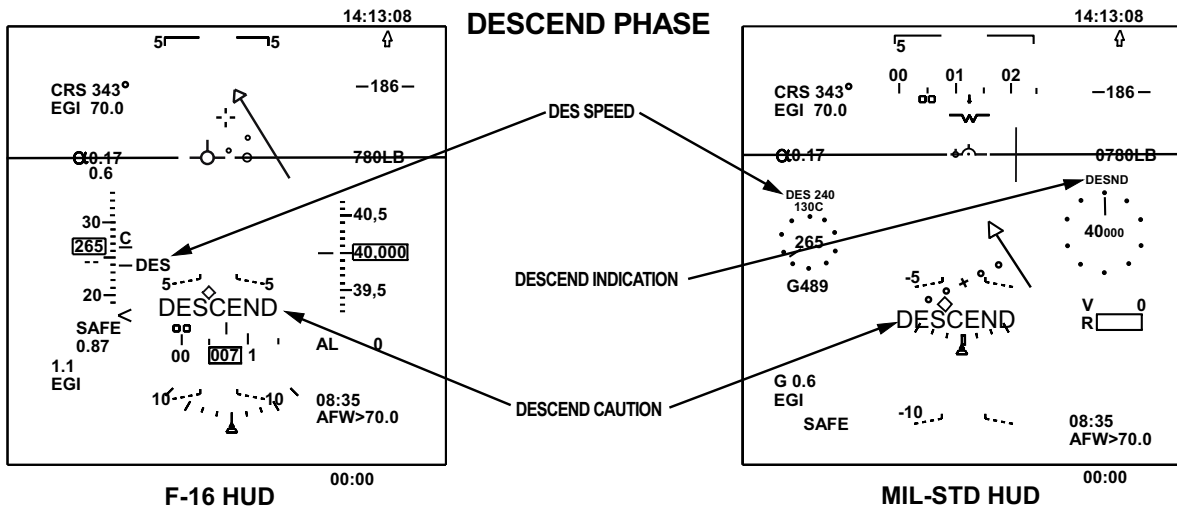

Figure 1-213. Emergency Divert Mode Displays (Sheet 2)

T38002-401-2-020

**DIVERT PROFILE
DESCEND PHASE**



T38002-401-3-020

Figure 1-213. Emergency Divert Mode Displays (Sheet 3)

RANGE (RNG) PROFILE

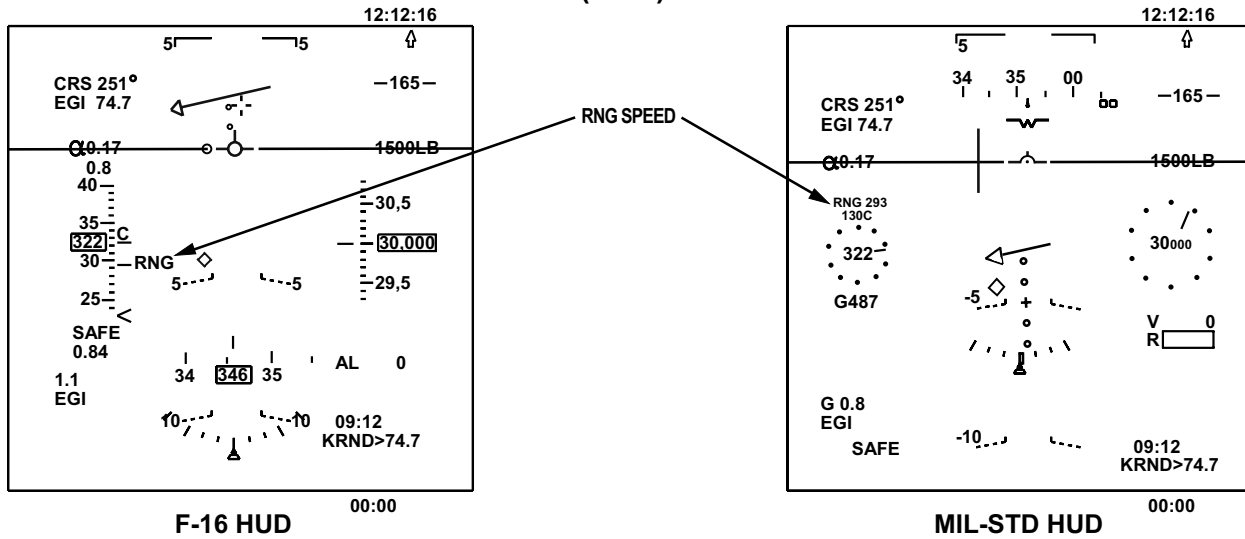

T38002-401-4-020

Figure 1-213. Emergency Divert Mode Displays (Sheet 4)

ENDURANCE (ENDR) PROFILE

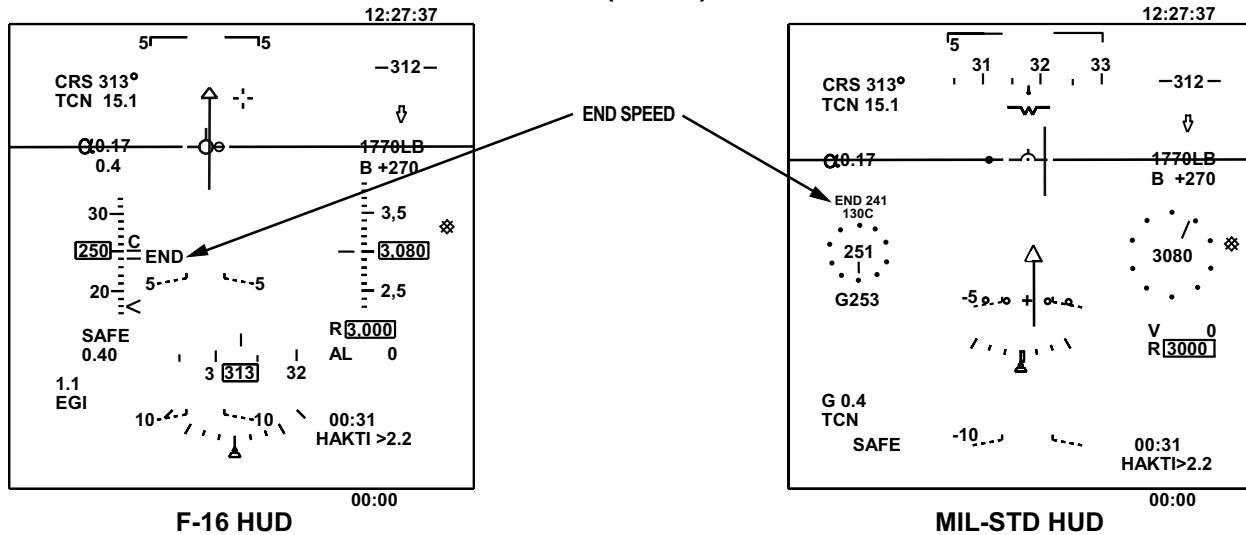

Figure 1-213. Emergency Divert Mode Displays (Sheet 5)

T38002-401-5-020

T.O. 1T-38C-1 GPS/INS

Range (RNG) Profile

RNG Profile, Figure 1-213, sheet 4, computes fuel remaining over the steerpoint and maximum range under current conditions, and commanded airspeed to achieve maximum range based on the following:

- a. Two engine performance (standard day)
- b. Aircrew selected aircraft configuration (CLEAN or POD)
- c. Engine type (PMP or NO_PMP)
- d. Current A/C gross weight
- e. Current A/C altitude
- f. Range to steerpoint
- g. Wind
- h. Temperature



- Failure to select the correct engine type and configuration (CLEAN or POD) results in erroneous RNG Profile solutions.
- RNG Profile information cannot account for situations requiring gear and/or flaps extended.

Commanded airspeed computations use data from the CONSTANT ALTITUDE CRUISE charts in T.O. 1T-38C-1-1, Appendices A and B.

RNG Profile information is updated 20 times per second to account for changes in actual altitude, airspeed, fuel remaining, fuel flow, wind, and temperature. The following parameters are displayed on the MFD and HUD, see Figure 1-213, sheet 4:

- a. DST FUEL - The estimated fuel remaining over the steerpoint. The projection is based on current aircraft parameters: EGI range, fuel flow, fuel quantity, and ground speed. The fuel computation assumes the aircraft stays at the current altitude all the way to the steerpoint. Negative values are displayed, if appropriate. DST FUEL is only displayed in the Emergency Divert Mode Display Block.

NOTE

When the steerpoint is a flight plan waypoint, the range used to calculate DST FUEL is the distance to the current waypoint plus cumulative distance to remaining points in the flight plan.

- b. RANGE - The maximum range of the aircraft based on the current configuration. The range is calculated from current groundspeed, fuel quantity, and fuel flow. Because the range calculations use these actual aircraft parameters, the aircraft configuration (flap and gear position and clean or WSSP) is indirectly factored into the range computation. The range computation assumes the aircraft stays at current altitude and includes 300 pounds of fuel for an approach. RANGE is only displayed in the Emergency Divert Mode Display Block.

- c. CAS - Commanded airspeed (displayed in both KCAS and Mach) to achieve maximum range at the current aircraft altitude. The calculation assumes two engines and standard day conditions. The max range speed is corrected for nonstandard temperature and winds. The commanded airspeed is indicated on the HUD and MFD airspeed indicators with the label RNG and in the Emergency Divert Mode Display Block.

Endurance (ENDR) Profile

ENDR Profile, computes the time to reach Bingo fuel under current conditions, and commanded airspeed to achieve maximum endurance at the current altitude based on the following:

- a. Two engine performance (standard day)
- b. Aircrew selected aircraft configuration (CLEAN or POD)
- c. Engine type (PMP or NO_PMP)
- d. Current A/C altitude
- e. Temperature



ENDR Profile information cannot account for situations requiring gear and/or flaps extended.

The commanded airspeed computations are based on data from the MAXIMUM ENDURANCE charts in T.O. 1T-38C-1-1, Appendices A and B.

NOTE

ENDR Profile is calculated using an aircraft gross weight of approximately 9200 pounds for BEFORE PMP and approximately 10,800 pounds for AFTER PMP.

ENDR Profile information is updated 20 times per second to account for changes in actual altitude, fuel remaining, fuel flow, wind, and temperature. The following parameters are displayed on the MFD and HUD, see Figure 1-213, sheet 5:

- a. BNGO - The time remaining to reach Bingo fuel is based on the BINGO setting, current fuel flow, and fuel remaining. The BNGO time is only displayed in the Emergency Divert Mode Display Block.
- b. CAS - The commanded airspeed (displayed in both knots and Mach) to achieve maximum endurance at the current aircraft altitude. The max endurance speed is corrected for nonstandard temperature. The commanded airspeed is displayed on the MFD and HUD airspeed indicator with the label END and in the Emergency Divert Mode Display Block, labeled CAS.

NAVIGATION TO A STEERPOINT

SELECTING A STEERPOINT

The EGI steerpoint is displayed in the following locations, Figure 1-214:

- a. UFCP - Window 1R of the Basic Menu Display.
- b. MFD - NAV Data Block (bottom line of the block).
- c. HUD - EGI Data Block (HUD bottom right corner).

Figure 1-214 also shows how different steerpoint types are depicted.

The only manual way to change the steerpoint is through the UFCP. Refer to UP FRONT CONTROL PANEL (UFCP), this section. When a 1 to 7 character waypoint, destination, or ICAO point identifier is entered, the new steerpoint is displayed (after validation) on the UFCP, MFD, and HUD. System steering is to the new point.

The steerpoint can be automatically incremented if the steerpoint is a waypoint and the auto function is selected on the UFCP NAV Sub-Menu Display. Refer to WAYPOINT SWITCHING, this section.

EGI NAVIGATION DISPLAYS

EGI navigation displays are shown in Figure 1-215.

For EGI navigation, a great circle magnetic course is maintained and continuously adjusted for curvature of the earth and changing magnetic variation. This course represents the course at the current position along the flight path rather than the initial or final course. When EGI is the PNS, this dynamic course is displayed in the CSW and used for the CDI and FD. When EGI is not the PNS, the displayed course becomes static and is no longer updated for curvature of the earth or magnetic variation changes, however the EGI course continues to be updated in the background.

The compass scale is oriented based on magnetic heading provided by the EGI for all EGI navigation solutions except GPS only. For the EGI GPS only solution, the compass scale is oriented based on ground track as calculated by the GPS. In this solution the INS still provides best attitude data for the EADI.

The following MFD displays are shown based on the steerpoint regardless of the PNS:

- a. The EGI bearing pointer (colored cyan) on the HSI/HSD points to the steerpoint, except during an SCA approach with the Final Interception Point (FIP) selected, when the EGI Bearing Pointer points to the tangent for the turn to the final course or to the FIP itself.
- b. The bottom line of the NAV Data Block shows the steerpoint.
- c. The TTG data (colored cyan) to the steerpoint is displayed in the lower right corner of the PFR and HSD Displays.
- d. Line 3 of the Range Data Block shows the range to the steerpoint.

T.O. 1T-38C-1

GPS/INS

- e. A FPL Course Line on the HSD.

The following HUD displays are shown based on the steerpoint regardless of the PNS:

- a. The EGI data block displays TTG to the steerpoint at the current ground speed, the waypoint/DEST/ICAO identifier, and range to the steerpoint.
- b. The TD box is shown for the steerpoint except in the A/A master mode or when the landing gear is down. All destinations and waypoints generate a TD box; ICAO points generate a TD box only when there is an elevation associated with them.

The following MFD Displays are shown based on the steerpoint with EGI as the PNS:

- a. The EHSI CDI and CSW are colored cyan.
- b. The EGI range is boxed.

c. FD commands are based on the EGI steerpoint and selected course.

d. On the HSD, the steerpoint is identified by a bold dot and identifier (colored cyan). A cyan colored course is drawn through the steerpoint to reflect the current selected course within the display range scale limits. Only the steerpoint is labeled on the HSD.

The following HUD Displays are shown based on the steerpoint with EGI as the PNS:

- a. The MIL-STD HUD Bearing Arrow and Radial Readout.
- b. The F-16 HUD Bearing Arrow and Radial Readout.
- c. The CDI provides raw data to the selected course.

HUD/MFD/UFPC DISPLAY LOCATIONS

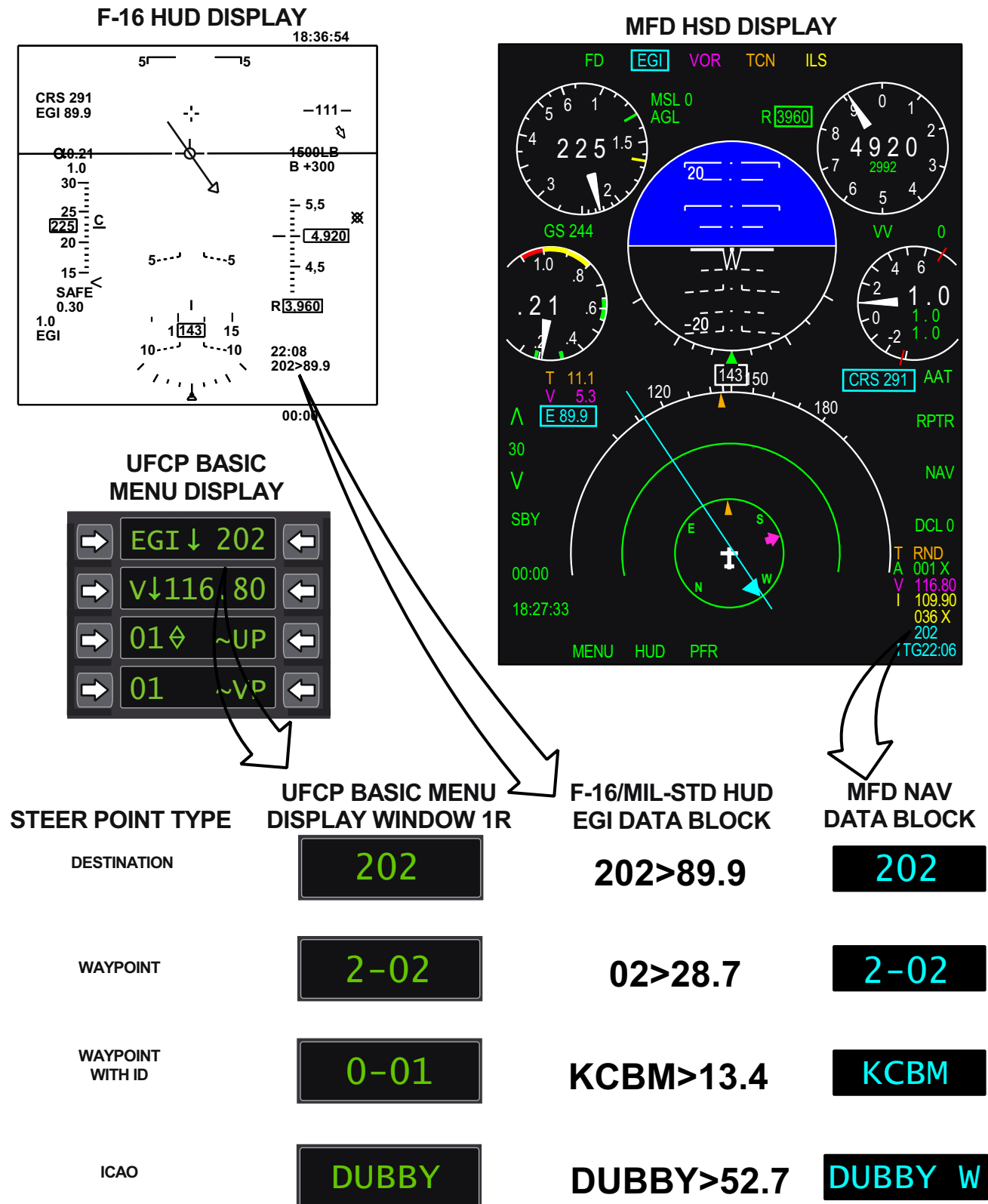

T38002-402-1-020

Figure 1-214. EGI Steerpoint Display

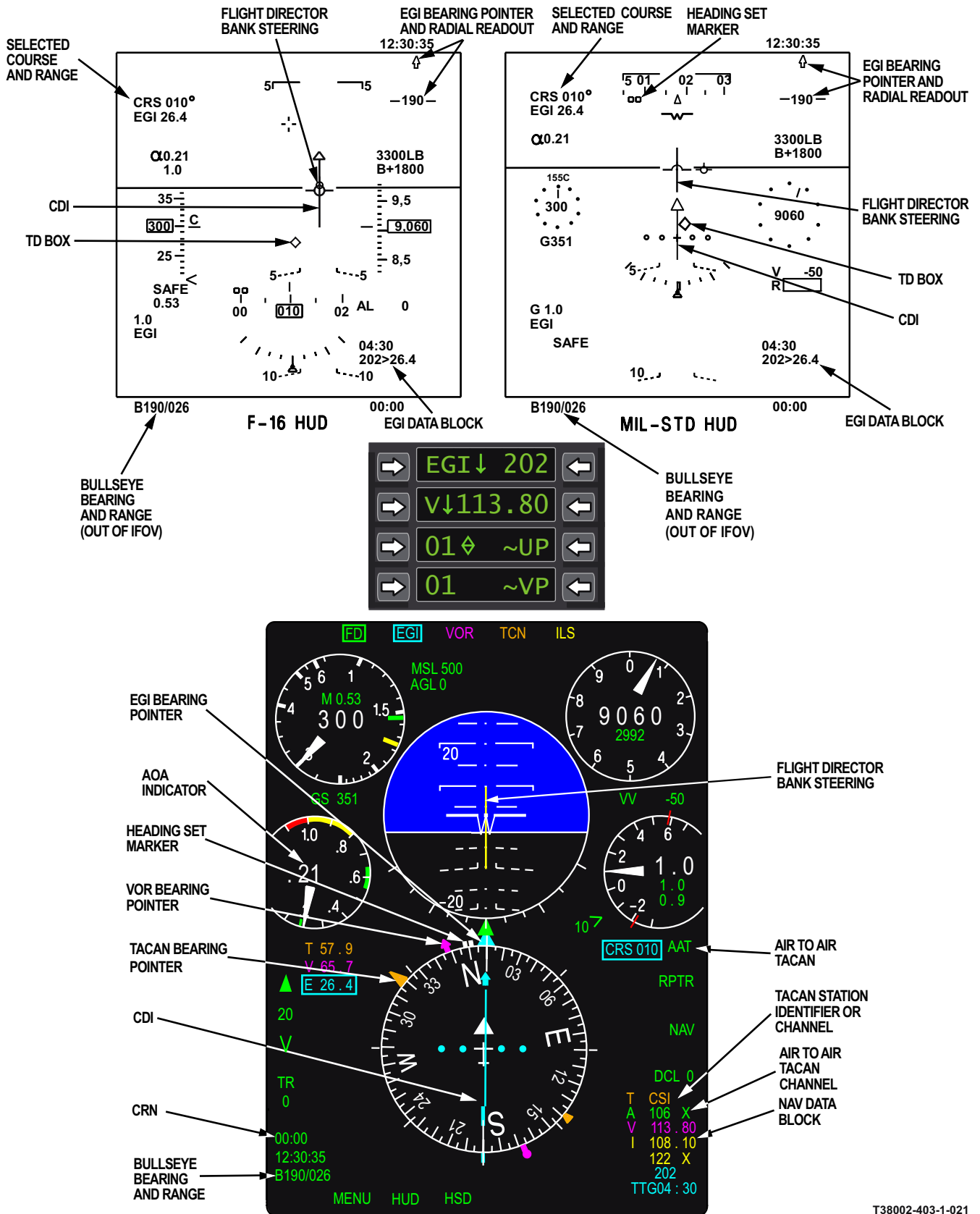

T38002-403-1-021

Figure 1-215. EGI Navigation Displays

NEAREST AIRPORTS

NOTE

The NEAREST AIRPORTS functionality is available only when mission planning data is provided from JMPS.

The NEAREST AIRPORTS Display Page can be accessed by selecting MR-7 on the MENU Display Page or by selecting N on the UFCP (Shortcut Key). The NEAREST AIRPORTS Display Page lists the 10 airports nearest to own aircraft, sorted nearest to farthest (nearest at the top of the list and farthest at the bottom of the list).

The aircrew can move the selection cursor to each listed airport by pressing ML-4 or ML-6 on the NEAREST AIRPORTS Display Page. A boxed INFO section at the bottom of the MFD displays navigation, runway, and radio data for the airport selected with the cursor. The contents of the INFO section are automatically updated as the selection cursor is moved. Each airport listed can be selected through the MFD SELECT button at ML-5. An asterisk appears next to the selected airport and remains until another airport is selected from the list or a new steerpoint is entered through the UFCP. After an airport from the list is selected, that airport becomes the steerpoint and divert mode is automatically selected. Selection of the runway length criteria button at MR-5 updates the list per the new runway criteria displayed at MR-5. The runway length criteria defaults to 8000 upon MDP start-up. No runways with a length less than the current runway criteria value are displayed in the list. See NEAREST AIRPORTS DATABASE and NEAREST AIRPORTS DISPLAY, this section.

FLIGHT PLAN DATABASE MANAGEMENT

Each FPL is a collection of points that reside in the navigation database. The definition of a FPL allows aircrew to follow the predefined navigation route and arrive on time, using heading and speed commands displayed on both HUDs.

FLIGHT PLAN DEFINITIONS

The navigation database can define and store up to 10 FPLs (numbered 0 thru 9); each FPL can consist of up to 15 points allotted to be waypoints numbered 1 thru 15.

The FPL route is defined by its waypoints, with every two waypoints defining a leg of the route. Lines are generated on the HSD connecting the waypoints. The FD commands steering along the FPL route of flight. A time schedule can be defined by assigning a TOT to any or all of the waypoints, so that the avionics system can provide speed commands for on-time arrival over the waypoints.

Destination 200

The LAT/LON where the EGI alignment is conducted is assigned to DEST 200. This point is automatically defined as waypoint 00 for all FPLs. The waypoint number 00 can be selected but is not part of the FPL.

Destinations 201-350

The parameters of these DEST points are defined initially through the mission planning system and are then allotted as waypoints for FPLs as follows:

T.O. 1T-38C-1
GPS/INS

DESTINATIONS	FLIGHT PLAN
201-215	0
216-230	1
231-245	2
246-260	3
261-275	4
276-290	5
291-305	6
306-320	7
321-335	8
336-350	9

The parameters of these DEST points can be initially defined through the mission planning system and then manually changed by the aircrew through the UFCP DST Key Display.

Last Waypoint

The last waypoint of the flight plan is defined as the one before the waypoint assigned to destination 999, which is a dummy point number used to define the end of the flight plan. If 999 is not assigned to any waypoint, the last waypoint is 15.

REVIEWING FPLs

The aircrew can review the content of each FPL through the FPL Display Page or the UFCP FPL Key Display. Refer to MFD MENU AND FUNCTION DISPLAY PAGES or UFCP FUNCTION KEYS, this section, for description and functionality.

NOTE

Selecting a FPL for navigation through the UFCP FPL Function Key or UFCP Nav Sub-Menu causes the MFD displayed FPL page (if currently viewing a FPL) to automatically revert to the UFCP selected FPL.

CREATING/EDITING FPLs

The aircrew can insert any defined DEST point or ICAO point into a FPL, can delete any FPL waypoint from a FPL, and update TOT information through the UFCP FPL Key Display. Refer to UFCP FUNCTION KEYS, this section, for description and functionality.

FLIGHT PLAN NAVIGATION

After a FPL is loaded from the DTC or created in the aircraft through the UFCP, it is available for navigation at any time. It can be used in any of the following ways:

With EGI selected as the PNS and FPL as the EGI source, the EGI navigation data is affected as follows:

- a. The EGI Bearing Pointer indicates the bearing to the selected waypoint.
- b. The range is the direct distance to the selected waypoint.
- c. The FD and CDI use the selected course to generate steering commands to intercept the course.
- d. TOT calculations generate a speed command in all master modes using mileage direct to the selected waypoint and all subsequent waypoints up to the next TOT assigned waypoint. To display an accurate commanded speed on the HUD and MFD, the current or subsequent waypoint must have a valid TOT.

When EGI is not the PNS and FPL is selected as the EGI source, EGI bearing, range, and TOT are based on the current waypoint. FPL course lines and labeled waypoints are displayed on the HSD. The CDI and FD commands are relative to the selected PNS.

When EGI is not the PNS and FPL is not selected as the EGI source (the steerpoint is not a waypoint), the only FPL display presentation is the course lines on the HSD.

SELECTING A FPL

The current FPL number can be viewed and changed through the UFCP NAV Sub-Menu, Window 3R/UR-3. See Figure 1-216.

SELECTING A FLIGHT PLAN AS THE EGI SOURCE

To select a FPL as the EGI source (EGI does not need to be the PNS), select a waypoint (1 thru 15) in the UFCP Basic Menu Display (Figure 1-217), Window 1R/UR-1; this selection cannot be made when SCA is the PNS, but it is available with all other options (EGI, TCN, VOR, ILS, LOC, or BC).

SELECTING A WAYPOINT

Aircrew can select a waypoint by typing the waypoint number (e.g., 3 or 03) in Window 1R/UR1 of the UFCP Basic Menu Display; once the data entry has

waypoint of the currently selected FPL with FPL 0 as the default when a FPL.

USING FD WITH A FPL

When FD is activated, bank steering cues are displayed on the EADI and HUD and provide steering to intercept the defined course (displayed on the MFD CSW and UFCP SET Key Display) to the selected waypoint. Bank steering is not available on either HUD in either A/A or A/G Master Modes; refer to T.O. 1T-38C-34-1-1.

DEVIATING FROM A FPL

The selected course can be manually changed by the aircrew at any time using the MFD CRS Rocker Switch or the UFCP SET Key Display, Window 2L/UL-2. When the course is changed manually, Figure 1-223, sheet 2, a cyan track line is displayed on the HSD to indicate a manually selected track to the selected waypoint.

The EHSI CDI and HUD CDI also represent the manual track to the waypoint. Steering is commanded to the cyan track line as in normal EGI navigation and the manually selected course is continuously adjusted for curvature of the earth and changing magnetic variation. When a new waypoint is selected (manually or automatically), a new course is displayed between the selected and previous waypoints, the manual cyan track line is removed, and normal FPL steering resumes.

FPL NAVIGATION DISPLAYS

MFD displays are shown in Figure 1-223, sheet 1, with EGI as the PNS and FPL selected as the EGI source.

EGI Bearing Pointer

The EGI Bearing Pointer points to the selected waypoint on the HSD and HSI displays and on the HUD.

Range and TTG

Range and TTG calculations are based on the selected waypoint and displayed on the HUD and MFD.

Waypoints and Course Line

The waypoints visible within the HSD selected range scale are presented on the HSD; only the current selected waypoint is numbered. White lines connect



Figure 1-216. UFCP NAV Sub-Menu Displays T38002-404-1-020

been validated and identified as a waypoint, it is displayed in a format of FPL#-waypoint# (e.g., 2-03). A valid waypoint must be between 00 and the last

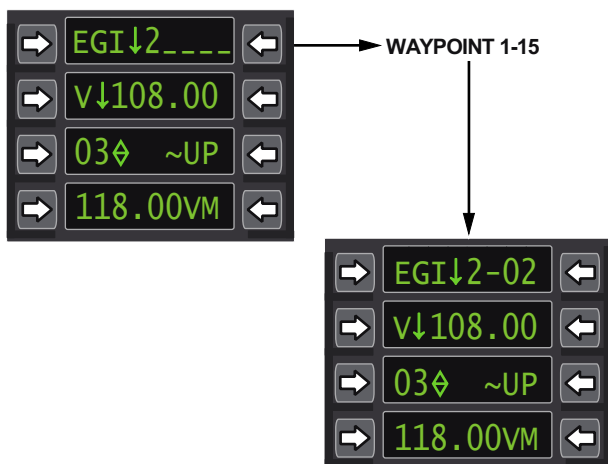

Figure 1-217. UFCP Basic Menu Display T38002-405-1-020

T.O. 1T-38C-1 GPS/INS

the waypoints (except 00 to 01 and last waypoint to 00), defining the course between the waypoints (legs of the FPL).

COURSE DEVIATION INDICATOR (CDI)

The EHSI CDI (colored cyan) and HUD CDI represent raw data to the system generated course from the previous FPL point to the selected point.

FLIGHT DIRECTOR (FD)

When FD is selected, bank steering cues are displayed on the EADI and HUD, providing steering to intercept the defined course (as displayed in the CSW and UFCP SET Key Display, Window 2L), to the selected waypoint. Bank steering is not displayed on either HUD if A/A or A/G Master Mode is selected.

COURSE SELECT WINDOW (CSW)

Whenever the selected waypoint within a FPL changes, the EGI course (background course if EGI is not PNS) is automatically initialized for the new flight path. Changing the course manually always initializes the displayed course and, if EGI is not the PNS, the background EGI course.

WAYPOINT SWITCHING

Manual (MAN) Waypoint Switching

Manual switching is accomplished through the UFCP Basic Menu Display, Window 1/UR-1. Entering a value between 1 and 15 selects that waypoint in the current FPL. This can be done any time, with either manual or automatic switching selected, regardless of the PNS.

Changing EGI Steerpoint

The navigation steerpoint can also be changed by pressing the Inc/Dec on the UFCP Basic Menu Display, Figure 1-218. The UFCP 5 key on the numeric keypad can be used to bring the Inc/Dec symbol into the steerpoint window (Window 1R/UR-1). When the Inc/Dec symbol is displayed at Window 1R, the Inc/Dec keys are operative on the steerpoint. Inc/Dec is operative on the steerpoint when it is a DEST (i.e., a three digit number between 200 and 509, or 600-610) or a FPL waypoint, but not when the steerpoint is an ICAO.

Performing the Inc/Dec operation on the steerpoint is mechanized as follows:



T38002-410-1-020

Figure 1-218. UFCP Basic Menu Display

Steerpoint is a DEST point. Performing the increment operation (pressing the 2/+ key) or the decrement operation (pressing the 8/- key) causes the DEST point to increment or decrement by one, respectively; unprogrammed or invalid DEST points are skipped.

- Once the top of the list is reached, incrementing changes the steerpoint to 200.
- Once the bottom of the list is reached (DEST 200), decrementing goes to the top of the list.
- If the steerpoint is at the top of the 200 thru 500 series DEST points, and increment is performed, the steerpoint skips to the first of the 600-610 series DEST points, if one is defined.

Steerpoint is a FPL waypoint. Performing the increment operation (pressing the 2/+ key) or the decrement operation (pressing the 8/- key) causes the FPL waypoint to change to the next or previous FPL waypoint, respectively.

d. When the last waypoint in the FPL is the steerpoint, incrementing changes the steerpoint to 00 (DEST 200).

e. When waypoint 00 is selected, decrementing changes the steerpoint to the last waypoint of the FPL.

The Inc/Dec symbol is displayed in Window 1R of the UFCP Basic Menu Display, Figure 1-219 and Figure 1-220, for the steerpoint as follows:

- a. DEST number



T38002-406-1-020

Figure 1-219. DEST Number

- b. FPL waypoint number.



T38002-406-2-020

Figure 1-220. FPL Waypoint Number

- c. ICAO destination - Inc/Dec is not displayed.

Automatic (AUT) Waypoint Switching

On MDP powerup the default sequencing is AUT. Automatic waypoint switching is activated when AUT is selected on the UFCP NAV Sub-Menu Display, Window 3L/UL-3, Figure 1-221. The steerpoint is changed automatically in sequential order until the last waypoint of the navigation route, from which waypoint 00 is automatically selected. Manual selection of any steerpoint is possible when automatic waypoint switching is activated.

Automatic waypoint switching is possible when all the following conditions are met:

- a. The current selected waypoint is not 00.
- b. The FPL must be the selected EGI source (the steerpoint is a waypoint). EGI does not have to be the PNS.
- c. AUT waypoint switching is selected on the UFCP NAV Sub-Menu Display, Window 3L.

AUT waypoint switching behavior is affected by the steering type assignment for the FPL waypoints. Steering types available for selection in the mission planning system and in the aircraft through the UFCP Flight Plan Sub-Menu are displayed as follows:



T38002-407-1-020

Figure 1-221. UFCP NAV Sub-Menu Display

- a. FBY - flyby.
- b. OVR - flyover.
- c. IAF - initial approach fix.
- d. FAF - final approach fix.
- e. APT - airport.
- f. MIS - missed approach point.

There is no difference between FBY and IAF steering types. For FBY and IAF waypoints, auto-switching is initiated when the turn lead point is reached, see Figure 1-222. This position is the computed point at which a turn must be initiated in order to intercept the next leg of the FPL. For turn angles equal to or greater than 30°, the lead point is based on a 30° bank turn. For smaller turn angles, the lead point is based on a bank angle equal to the turn angle. The lead point is continuously computed based on current airspeed, ground track, wind and range to steerpoint.

Initiating a turn at the lead point using these bank angles results in the aircraft reaching the next leg within the initial lead point distance from the steerpoint. TTG calculations are based on the waypoint rather than the lead point. Auto-switching at FBY and IAF waypoints is inhibited until range to the steerpoint is less than 7 NM. For turn angles greater than 120° and at high speeds, the lead point can exceed 7 NM. In these cases the auto sequence does not occur until after the lead point, causing the aircraft to overshoot the next leg.

T.O. 1T-38C-1
GPS/INS

OVR and FAF steering types have the same AUT waypoint switching rules, but the FAF is displayed on the HSD with the FAF cross symbol. For OVR and FAF, AUT waypoint switching occurs when the aircraft passes within 2 NM of the waypoint and the EGI Bearing Pointer swings through the 3 or 9 o'clock position relative to the nose of the aircraft. AUT waypoint switching does not occur when the current steerpoint has a steering type of APT, or the next waypoint has a steering type of MIS. Auto sequencing is suspended until aircrew manually select another waypoint. APT waypoints are displayed on the HSD with an airport circle symbol. When the last waypoint is reached, the next automatically selected waypoint is 00.

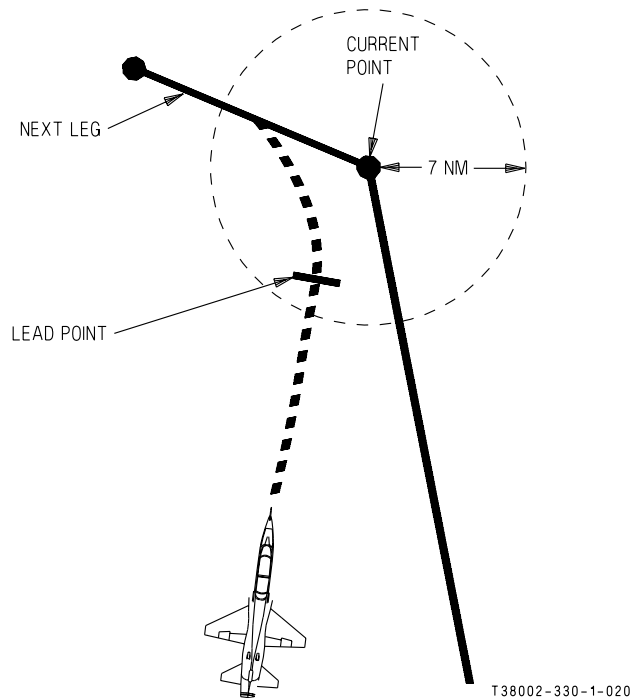

Figure 1-222. Auto-Waypoint Switching Fly-By and IAF Waypoints

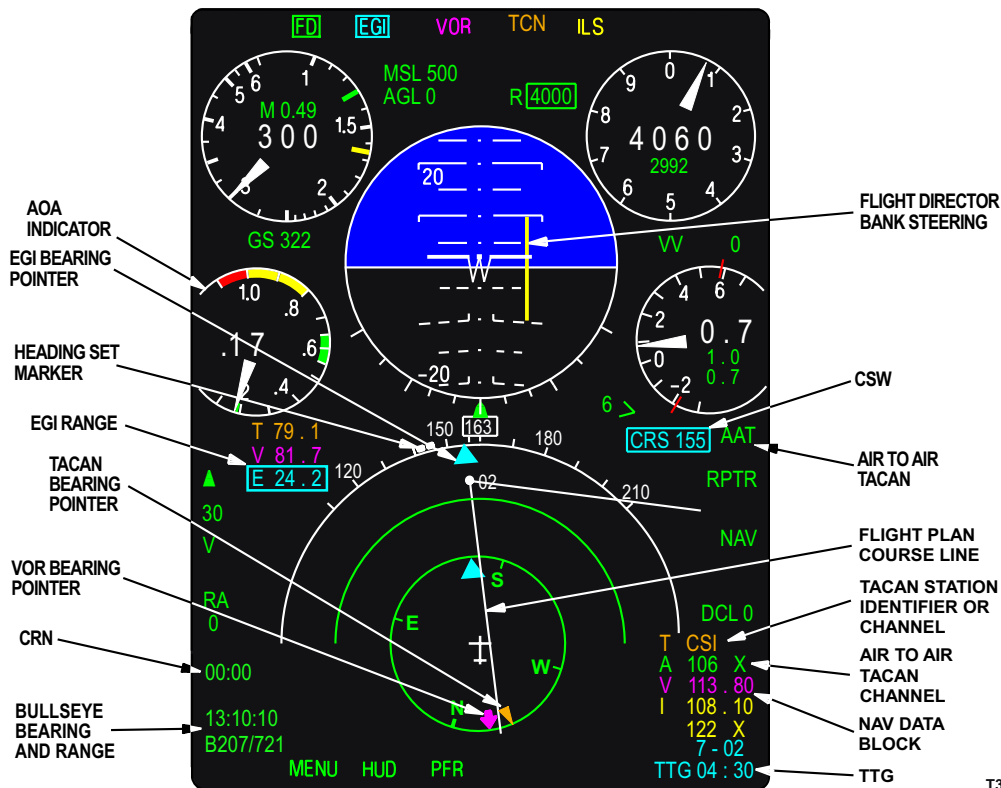
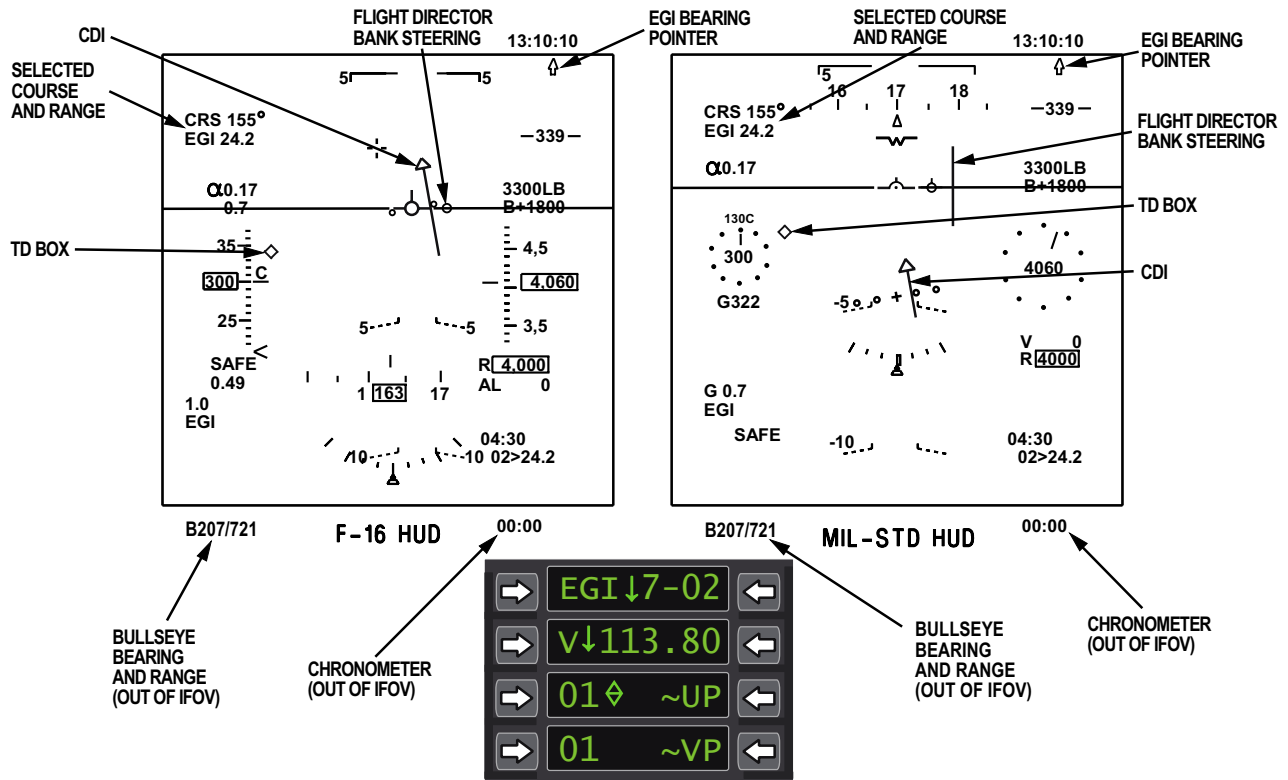
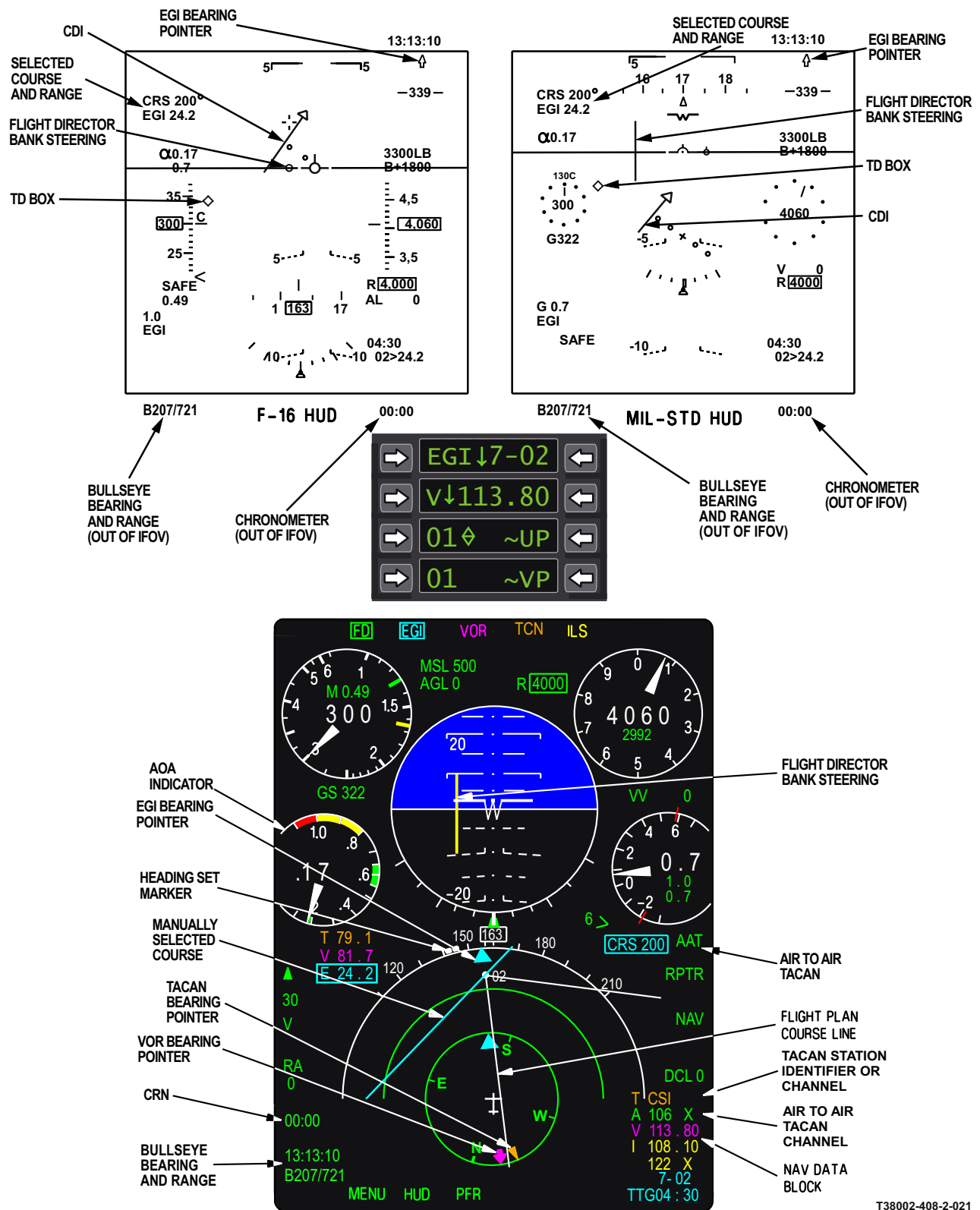

Figure 1-223. Flight Plan Displays (Sheet 1 of 2)

T38002-408-1-020

T.O. 1T-38C-1
GPS/INS



T38002-408-2-021

Figure 1-223. Flight Plan Displays (Manually Selected Course) (Sheet 2)

FLIGHT PLAN OPERATIONS IF EGI IS NOT THE PNS

If FPL is the EGI source and EGI or SCA is not the PNS (operating in VOR, ILS, LOC, BC or TACAN), operations are as follows:

- a. MFD displays are consistent with source selection rules; e.g., if the VOR is the PNS, the CDI and CSW are colored magenta, the DME is boxed, and all FD steering commands are based on the selected VOR course.
- b. AUT waypoint switching continues if the criteria are met.
- c. FPL course lines are available on the HSD; the selected waypoint number is displayed.
- d. Waypoint sequencing does not affect the selected course, nor is the selected course updated for curvature of the earth or magnetic variation. Although sequencing forces a new selected course on the background FPL (updated for curvature of the earth and magnetic variation), the system continues to use the last selected course.

FPL Is Active But In The Background

If a FPL is not the EGI source but EGI is the PNS (FPL is active but in the background), as evidenced by either a three-digit DEST or an ICAO point displayed on the UFCP Basic Menu Display, Window 1R, operations are as follows:

- a. The HSD displays the current course line (cyan); the DEST/ICAO point is labeled.
- b. The HSD displays FPL course lines (white), waypoints are not labeled.
- c. AUT waypoint switching does not occur.
- d. FPL steering commands are not generated.
- e. The selected course can be initialized manually at any time. Once a course is initialized, a great circle has been defined based on the steerpoint and chosen course. The course is then automatically and continuously updated to reflect the changes in magnetic variation and curvature of the earth.
- f. If the aircrew selects FD, steering commands are referenced to the steerpoint or programmed approach.

TOT CALCULATIONS

When creating a FPL, each waypoint consists of two components: coordinates and TOT. The TOT is optional, and can be referenced to either TOD (Time of Day) or chronometer time. The system uses either the TOD or chronometer for calculations depending on which is selected on the UFCP CLK Key Display. The clock selected affects the time difference calculation. Whichever TOT is referenced, TOD or chronometer should correlate with the clock selected on the UFCP CLK Key Display. If not, the system generated speed commands are not displayed.

Any number of waypoints along a FPL can be assigned a TOT. The TOT can be assigned by the mission planning system and updated via the UFCP FPL Key Display.

If a FPL is selected (a waypoint displayed in UFCP Basic Menu Display, Window 1R) the selected FPL has at least one waypoint with a TOT assigned to it, and TOT is enabled via UL-2 on the UFCP TOT Sub-Menu (indicated by an asterisk next to TOT), system generated speed commands are displayed on the HUD and MFD, Figure 1-224. If the aircrew maintains the commanded airspeeds, arrival over the waypoints occurs at the assigned TOT times. The following assumptions are used:

- a. All calculations are based on the aircraft PP, current ground speed, distance to the point with a TOT along the FPL route, and the difference from the current time to the entered TOT.
- b. The route of flight is directly to the selected waypoint, then along the programmed FPL route to the waypoint containing the TOT. The system searches for the first waypoint containing a TOT which is located at or beyond the current steerpoint to use in the calculations.
- c. For TOT purposes, waypoint 00 is considered a DEST only (not part of the FPL) and, if selected as

T.O. 1T-38C-1 GPS/INS

the current steerpoint, does not generate a commanded airspeed.

WARNING

There are no limits to the commanded airspeed. The system commands, if followed, could potentially place the aircraft outside the flight envelope.

NOTE

The TOT calculations can be unreliable close to the target (within approximately 0.5 NM of the steerpoint) and/or set TOT (within 3 seconds).



Figure 1-224. Multifunctional Display Time on Target

GROUND BASED NAVIGATION

GROUND BASED NAVIGATION OVERVIEW

The ground based navigation system consists of the VOR/ILS and the TACAN/DME.

The VOR and ILS share a common receiver which provides VOR bearing data when tuned to a VOR frequency, or localizer and glideslope deviation data when tuned to an ILS frequency. VOR and ILS frequencies are entered independently via the UFCP. The VOR or ILS frequency is automatically sent to the VOR/ILS by the MDP based on the current PNS selection. When ILS, LOC, or BC is the selected PNS, the VOR/ILS is tuned to the ILS frequency. When any other PNS is selected, the VOR/ILS is tuned to the VOR frequency. The VOR bearing or ILS deviation data along with currently tuned frequency is provided to the MDP for display.

The TACAN/DME is a single transceiver that can simultaneously provide range-only DME data for VOR/ILS navigation and bearing/range data from a separately tuned TACAN or VORTAC station. The TACAN channel is entered via the UFCP and sent to the TACAN by the MDP. The TACAN bearing and range data along with currently tuned frequency is provided to the MDP for display.

The actual tuned frequency reported by the VOR/ILS to the MDP is also routed directly to the TACAN/DME and serves as the tuning source for the range-only DME function. Thus the range-only DME function of the TACAN/DME is always tuned to the VOR/ILS paired channel.

The TACAN/DME transceiver can be operated in an Air-to-Air TACAN (AAT) ranging mode. This mode transmits/receives range-only information to/from cooperatively tuned (63 channels apart) airborne platforms (e.g., wingman). When the TACAN is operating in AAT mode, all bearing and range information to ground stations is lost and removed from the displays.

The ground based navigation systems can be operated in normal mode or Nav Backup mode. Nav Backup mode is entered when selected by the aircrew via the AAP or automatically when the MDP is failed or off. In Nav Backup mode, control of the systems is accomplished via the respective backup control panels. If the MDP is operational, navigation displays in

Nav Backup mode are provided on the MFD and HUD the same as in normal mode with only minor exceptions.

Navigation data on the MFD is color-coded to reflect the navigation source; VOR is magenta, ILS is yellow, and TACAN is orange (EGI is cyan). Range and bearing, when available, are displayed for all navigation sources regardless of the selected PNS. However, Course Deviation Indicator (CDI), Vertical Deviation Indicator (VDI), and Flight Director (FD) are presented only for the selected PNS.

On the HUD, range, bearing, CDI, VDI, and FD are presented for the selected PNS.

VOR DISPLAYS

When the VOR is tuned (PNS is not ILS/LOC/BC), VOR information displays include the following:

- a. UFCP Basic Menu Display - The VOR commanded frequency is displayed ($V\downarrow###.##$) in Window 2 when VOR or EGI is the PNS, Figure 1-225. VOR frequency display is not available when TCN, ILS or SCA is the selected PNS.



T38002-589-1-020

Figure 1-225. UFCP Basic Menu Display

- b. MFD NAV Data Block, Figure 1-226, (Line 3, colored Magenta) - The tuned VOR frequency is displayed ($V###.##$). When ILS/LOC/BC is the PNS, line 3 displays the latent VOR frequency (commanded upon return to VOR). The NAV Data Block is displayed on both PFR and HSD but may be removed based on mission planned declutter options when DCL 2 (MR-6) is selected.



T38002-590-1-020

Figure 1-226. MFD NAV Data Block

c. When the VOR is receiving a valid station signal, the following MFD displays are also presented:

- (1) EHSI and HSD - The magenta VOR Bearing Pointer is displayed, Figure 1-230.
- (2) Range Data Block - VOR/ILS range window is colored magenta and displays DME data when available, Figure 1-230.

When VOR is the PNS:

a. The UFCP NAV Source Sub-Menu Display has an asterisk after VOR in Window 2L, Figure 1-227.



T38002-591-1-020

Figure 1-227. UFCP NAV Source Sub-Menu Display

b. The MFD displays, Figure 1-228, are as follows:

- (1) MOSB MT-3 Title Display VOR is boxed.
- (2) Range Data Block - The VOR/ILS range window is colored magenta and boxed.
- (3) CDI and CSW - Both are colored magenta.

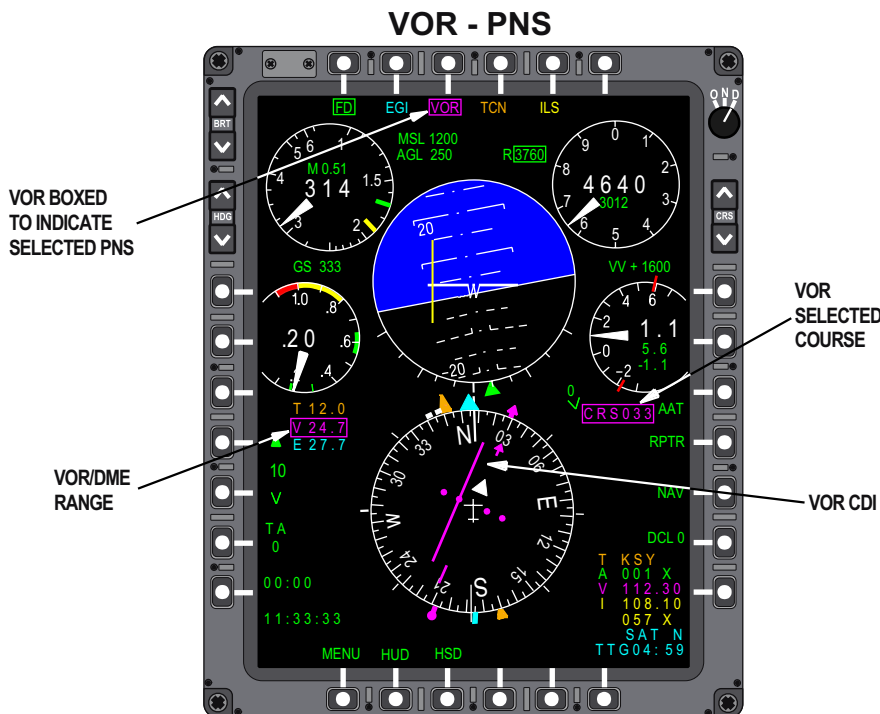

T38002-592-1-020

Figure 1-228. MFD PFR Display

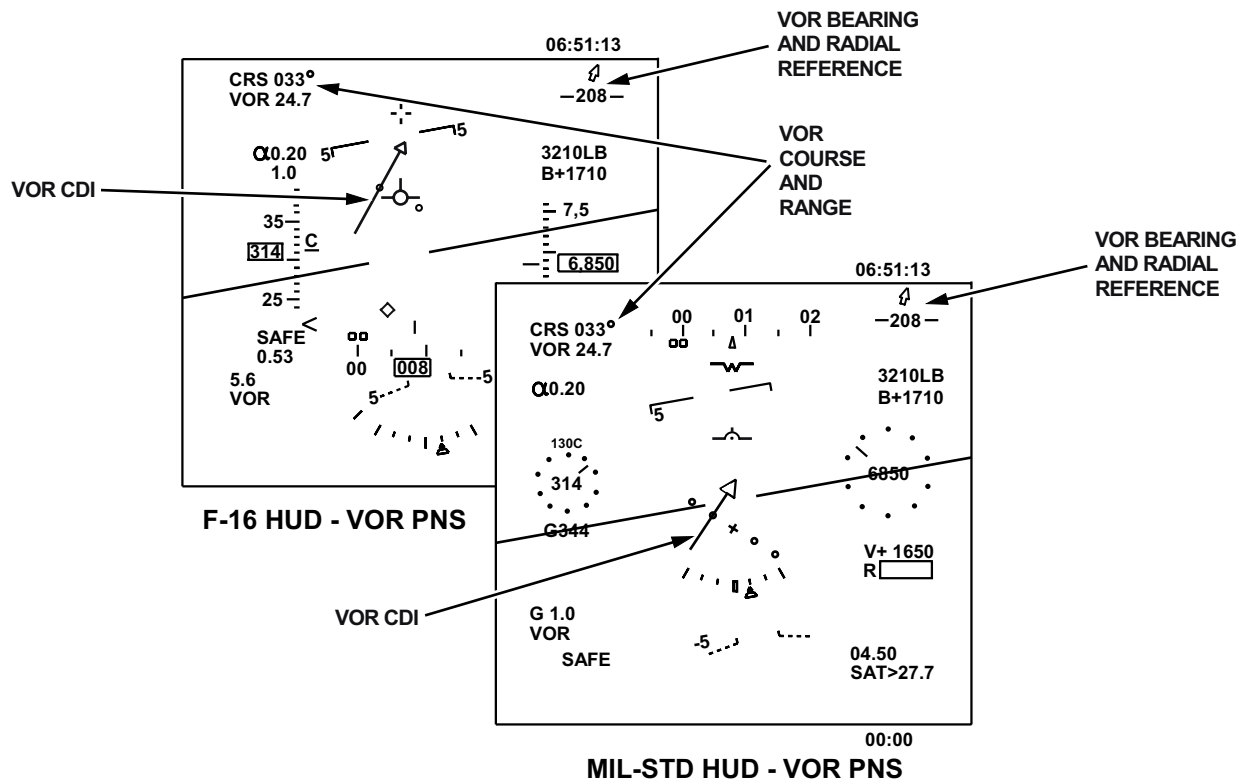

Figure 1-229. HUD - VOR PNS

T38002-593-1-020

c. The HUD (in NAV Master Mode only) displays the VOR Range under the CRS Display in the upper left corner. VOR is the prefix for this range, Figure 1-229.

d. When the VOR is receiving a valid station signal, the HUD CDI displays the deviation from the selected course to/from the VOR, Figure 1-229.

e. When the VOR is receiving a valid station signal, the HUD bearing arrow/radial readout are referenced to/from the VOR station, Figure 1-229.

f. FD is defaulted off, but can be selected for display on the HUD and the EADI. Refer to FLIGHT DIRECTOR LOGIC AND USAGE, this section.

NOTE

CRS, range, CDI, and bearing arrow/radial readout are not displayed on the HUD in A/A or A/G master modes

T.O. 1T-38C-1

GBN

VOR CONTROLS

VOR POWER CONTROL

The VOR/ILS is powered only when the AAP Backup Mode Control Knob is out of the OFF position and the NAV Backup Control Panel Mode Knob is out of the OFF position. Refer to AVIONICS ACTIVATION PANEL (AAP) and BACKUP CONTROL PANELS, this section.

VOR NORMAL/BACKUP MODE CONTROL

The VOR operates in normal mode when the AAP Backup Mode Control Knob is in the NORM or UHF B/U position. Refer to AVIONICS ACTIVATION PANEL (AAP), this section.

UFCP VOR CONTROLS

UFCP controls and displays used for VOR navigation, Figure 1-230, are as follows:

- a. Selection of VOR as the PNS is accomplished on the UFCP NAV Source Sub-Menu Display.
- b. The VOR frequency is selected via the UFCP NAVAID Sub-Menu Display. The VOR frequency can also be selected via Window 2 of the UFCP Basic Menu Display when VOR is the PNS.
- c. Selection of the VOR course is accomplished on the UFCP SET Key Display.
- d. Selection and display of the FD on/off status is accomplished on the UFCP NAV Sub-Menu Display. An asterisk is presented when FD is on.
- e. Selection of the VOR Bearing Pointer for PFR and HSD displays is accomplished on the UFCP Bearing Arrow Sub-Menu Display. An asterisk is

presented when bearing arrow display is enabled. When disabled, the MFD VOR Bearing Arrow and Range Window are removed from the display except when VOR is selected as the PNS.

MFD VOR CONTROLS

MFD controls used for VOR navigation, Figure 1-230, are as follows:

- a. Selection of VOR as the PNS is accomplished via MOSB MT-3 on MFD displays in all Master Modes. VOR (MOSB MT-3) is boxed when selected as the PNS.
- b. Selection of the desired VOR course is accomplished via the CRS Rocker Switch with display of the selected course (colored magenta) in the CSW.
- c. When VOR is the PNS, FD is defaulted off and can be toggled on/off with MOSB MT-1. FD (MOSB MT-1) is boxed when selected.

DME CHANNEL ASSOCIATED WITH VOR

The aircrew has no direct control of (or display of) the DME channel used for VOR/DME navigation. The DME is automatically tuned to the channel that is paired with the tuned VOR frequency.

AUDIO CONTROL PANEL (ACP)

Controls on the ACP allow monitoring of the NAVAID Morse code or voice identifier using the NAV Audio Control Switch. Refer to AUDIO CONTROL PANEL (ACP), this section.

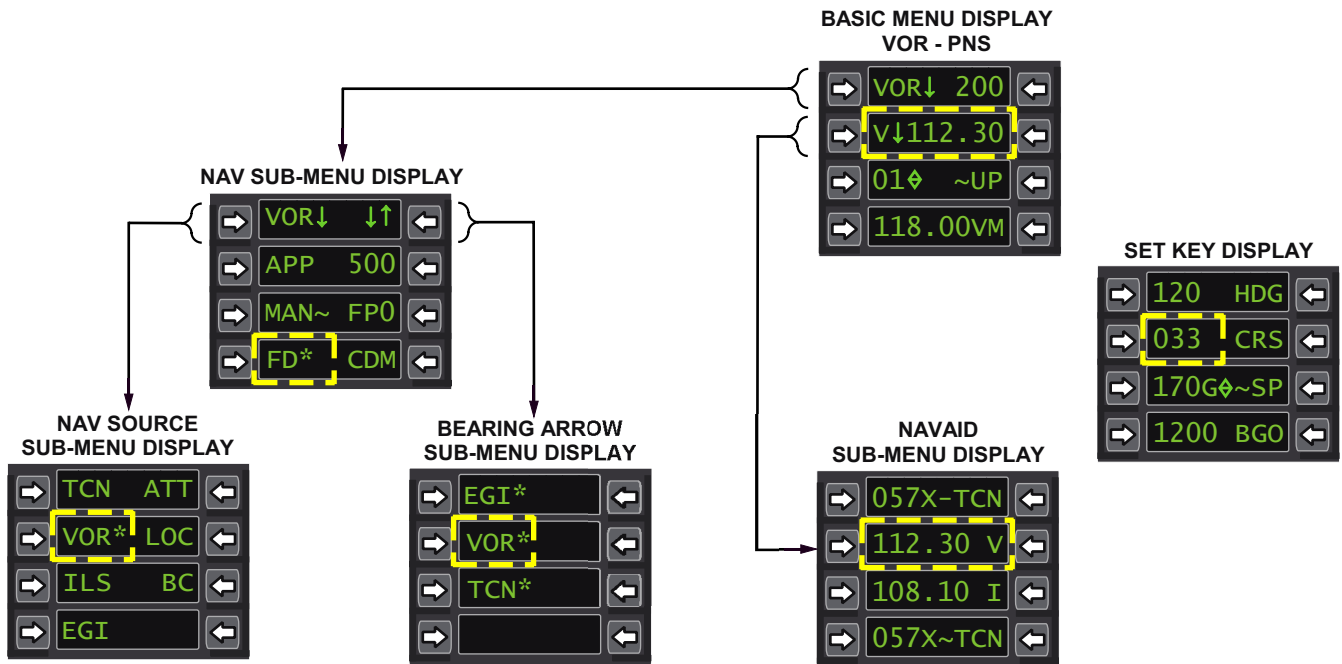

NOTE

SCA IS DISPLAYED IN WINDOW 4R OF THE NAV SOURCE SUB-MENU DISPLAY WHEN DOWN LOADED.

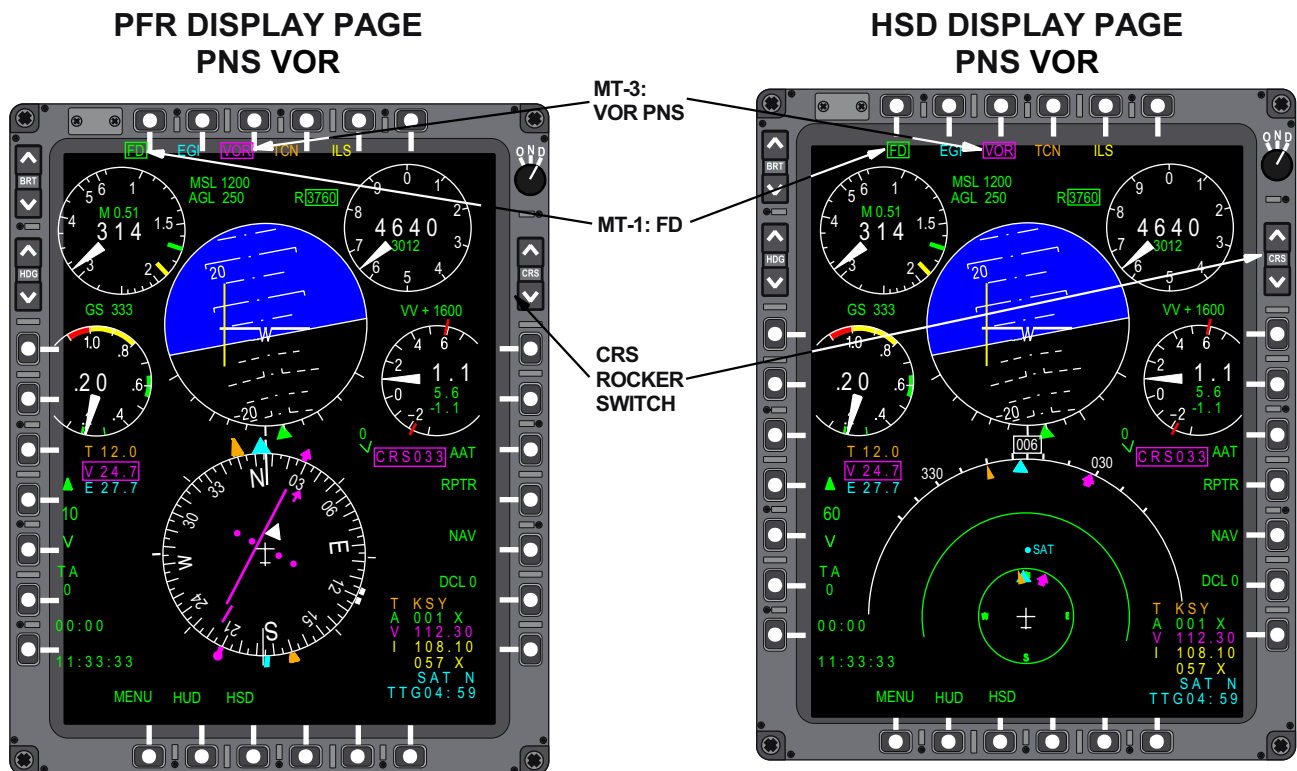

Figure 1-230. VOR Controls and Displays

T.O. 1T-38C-1

GBN

VOR NAVIGATION

To conduct VOR navigation, the selected PNS must be VOR. When receiving a valid signal, VOR raw data is displayed on the MFD at all times and on the HUD when in NAV Master Mode.

VOR/DME DISPLAYS

VOR/DME navigation displays for the HUD, UFCP, and PFR Display are shown in Figure 1-231.

VOR COURSE SELECTION

When VOR is selected, the initial course displayed in the CSW is the previous system course. It can be manually selected using either the CRS Rocker Switch or the UFCP SET Key Display, window 2L, Figure 1-230.

NOTE

Selection of the EGI as the PNS can result in course updates which may not be obvious to the aircrew. Therefore, when VOR is selected as the PNS following EGI, the desired course must be verified.

VOR MFD/HUD CDI DATA DISPLAY

Each dot of CDI deflection represents 5° off the selected course; full scale deflection represents 12° or more off the selected course.

VOR NAVIGATION BACKUP OPERATIONS

When the NAV Backup Control Panel, Figure 1-232, is active and is controlling navigation frequency selection, the aircrew must select a VOR frequency on the

NAV Backup Control Panel to conduct VOR operations. The system tunes the matched pair for DME reference. Refer to BACKUP CONTROL PANELS, this section.

When in Nav Backup (MDP operational with AAP Backup Mode Control Knob in NAV B/U or BOTH), VOR navigation backup operations require the following:

- a. Select a VOR frequency on the NAV Backup Control Panel.
- b. Select VOR as the PNS on the MFD or UFCP NAV Source Sub-Menu Display (VOR frequency must be tuned first; VOR is not a PNS option when the VOR/ILS is tuned to an ILS frequency).
- c. Select the desired VOR course via the CRS Rocker Switch or UFCP SET Key Display.

Navigation displays are provided on the MFD, Figure 1-231, and HUD the same as in normal mode except the ILS frequency is removed from the NAV Data block.

When the MDP is failed or off, Nav Backup is automatically selected, the MFD reverts to MFD Backup mode, and the audio is controlled by the FCP ACP NAV Audio Control Switch. VOR navigation backup operations require the following:

- a. Select a VOR frequency on the NAV Backup Control Panel.
- b. Select VOR as the PNS on the MFD Backup Display.
- c. Select the desired VOR course via the CRS Rocker Switch.

Navigation displays are limited to those provided on the MFD Backup display, refer to MFD BACKUP DISPLAY, this section.

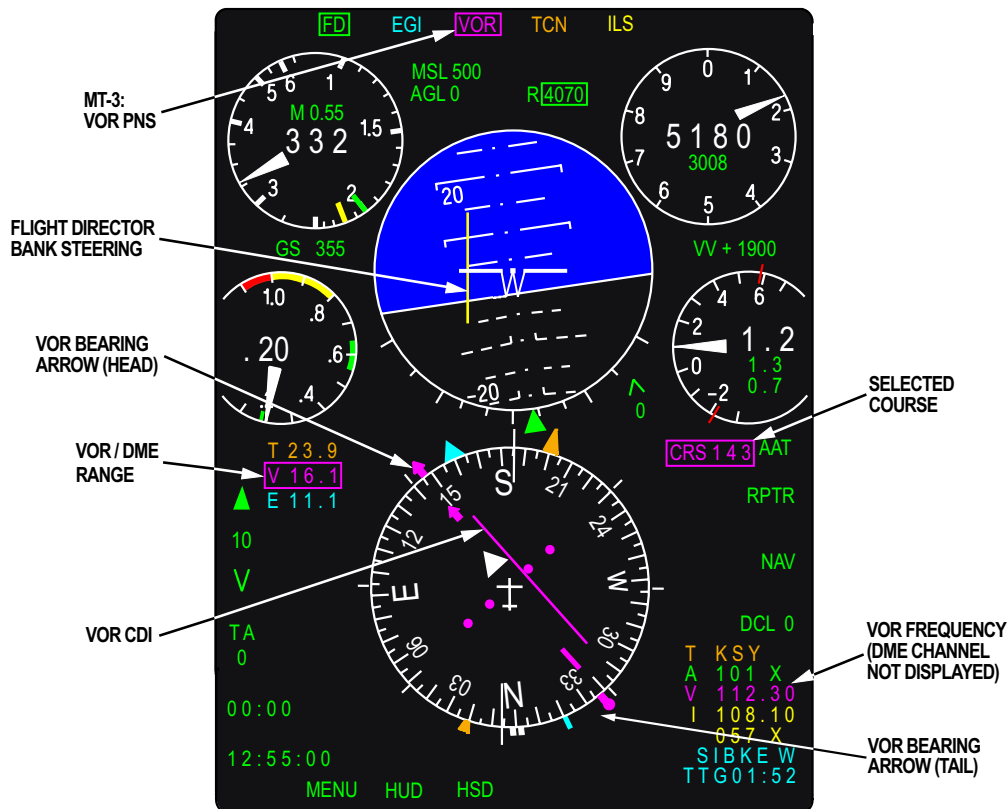
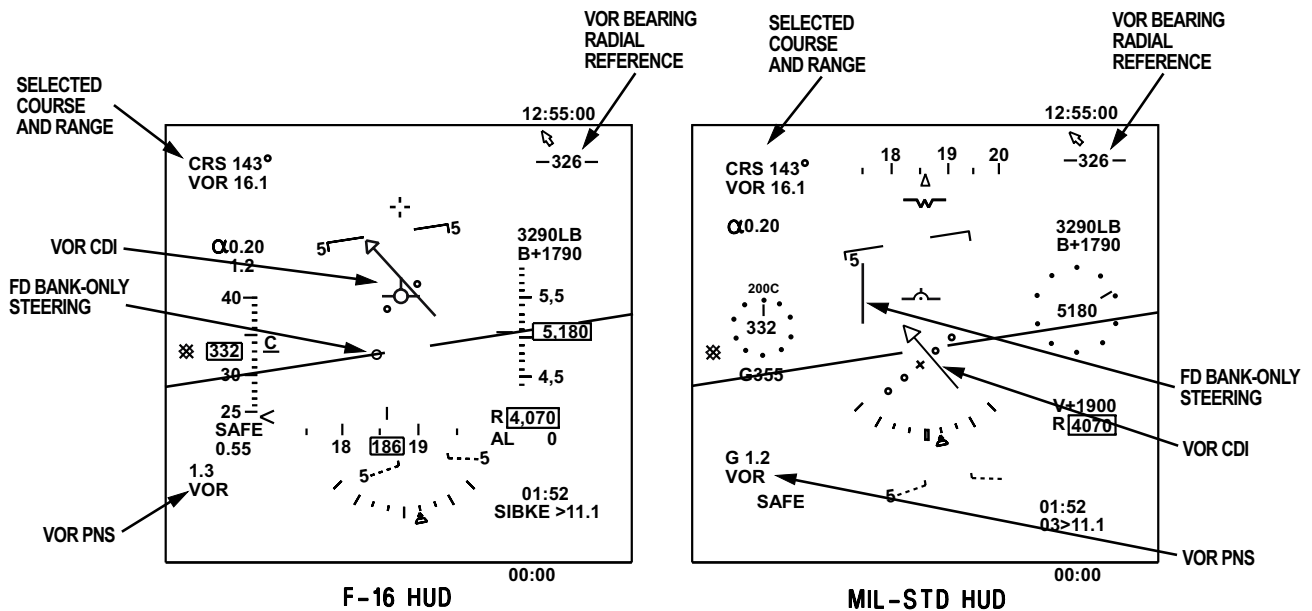

T38002-596-1-021

Figure 1-231. VOR Navigation Displays

NAV BACKUP CONTROL PANEL (VOR FREQUENCY SELECTED)



MFD BACKUP DISPLAY

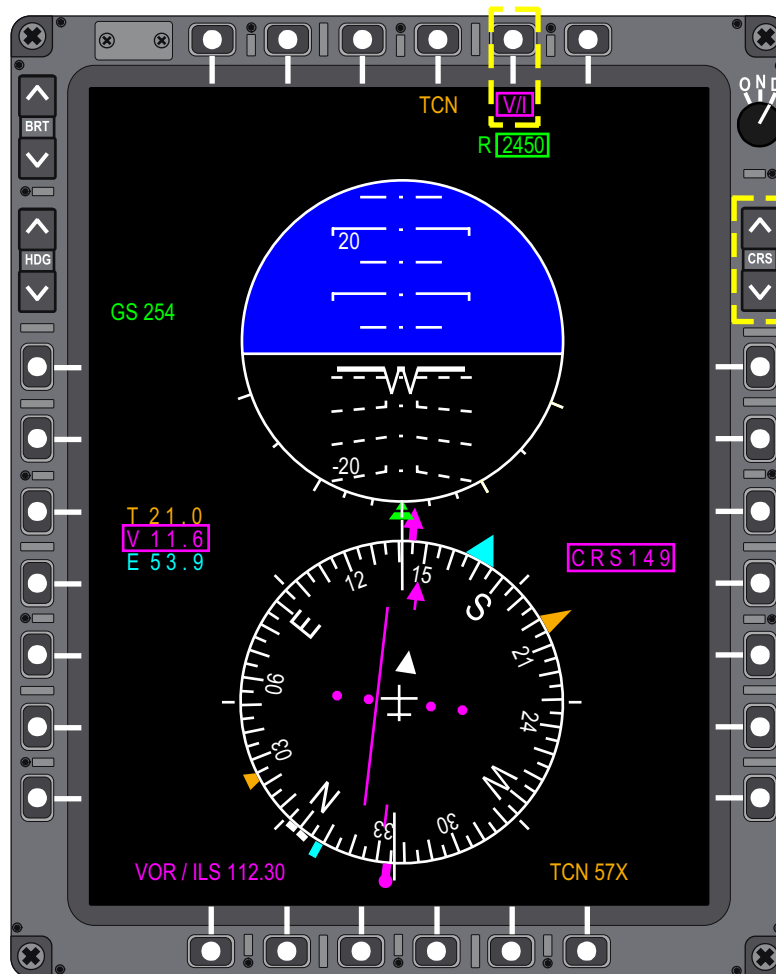

Figure 1-232. VOR Navigation Backup Operations

ILS DISPLAYS

When the ILS is tuned (PNS is ILS/LOC/BC), ILS information displays include the following:

a. The UFCP, Figure 1-233, displays ILS data as follows:

- (1) The Basic Menu Display shows the ILS commanded frequency as I↓ ###.## in Window 2.
- (2) The NAV Source Sub-Menu Display has an asterisk after ILS in Window 3L, an asterisk before LOC in Window 2R, or an asterisk before BC in Window 3R.

UFCP BASIC MENU DISPLAY

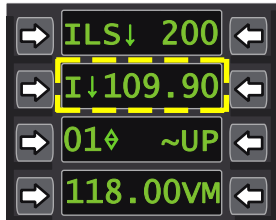

UFCP NAV SOURCE SUB-MENU DISPLAY



T38002-598-1-020

Figure 1-233. ILS Displays

b. MFD NAV Data Block, Figure 1-234, (Lines 4 and 5, colored Yellow) - The tuned ILS frequency, line 4, and the ILS range source channel (ILS paired DME or selected TACAN channel), line 5, are displayed (I ###.##) and (### X/Y), respectively. When ILS/LOC/BC is not the PNS, lines 4 and 5 display the latent ILS frequency and range source channel (commanded upon selection of ILS). The NAV Data Block is displayed on both PFR and HSD but may be removed when DCL 2 (MR-6) is active/selected or COMM Data (MR-7) is selected.

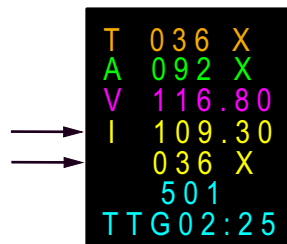

T38002-599-1-020

Figure 1-234. MFD NAV Data Block

c. The MFD displays, Figure 1-235, are as follows:

- (1) MT-5 MOSB Title Display - ILS is boxed.
- (2) Range Data Block - The VOR/ILS range window is colored Yellow and boxed.
- (3) CDI scale and CSW - Both are colored Yellow.
- (4) VDI scale - Displayed on the EADI with Yellow dots.
- (5) MOSB MT-1 Title Display - FD is boxed (Default is ON).

d. The HUD (in NAV Master Mode only), Figure 1-236, displays the following:

- (1) ILS Range under the CRS Display in the upper left corner; ILS is the prefix for this range. Range is displayed based on reception of the paired DME or TACAN, as selected.
- (2) MIL-STD HUD - FD Pitch and Bank Steering and Localizer/Glideslope Raw Data are displayed upon reception of Localizer signal.
- (3) F-16 HUD - FD Pitch and Bank Steering and Localizer/Glideslope Raw Data are displayed upon reception of Localizer signal.
- (4) In ILS, the HUD bearing arrow/radial readout are referenced to the TCN or VORTAC station when the TACAN is tuned and receiving a valid signal.

ILS (PNS)

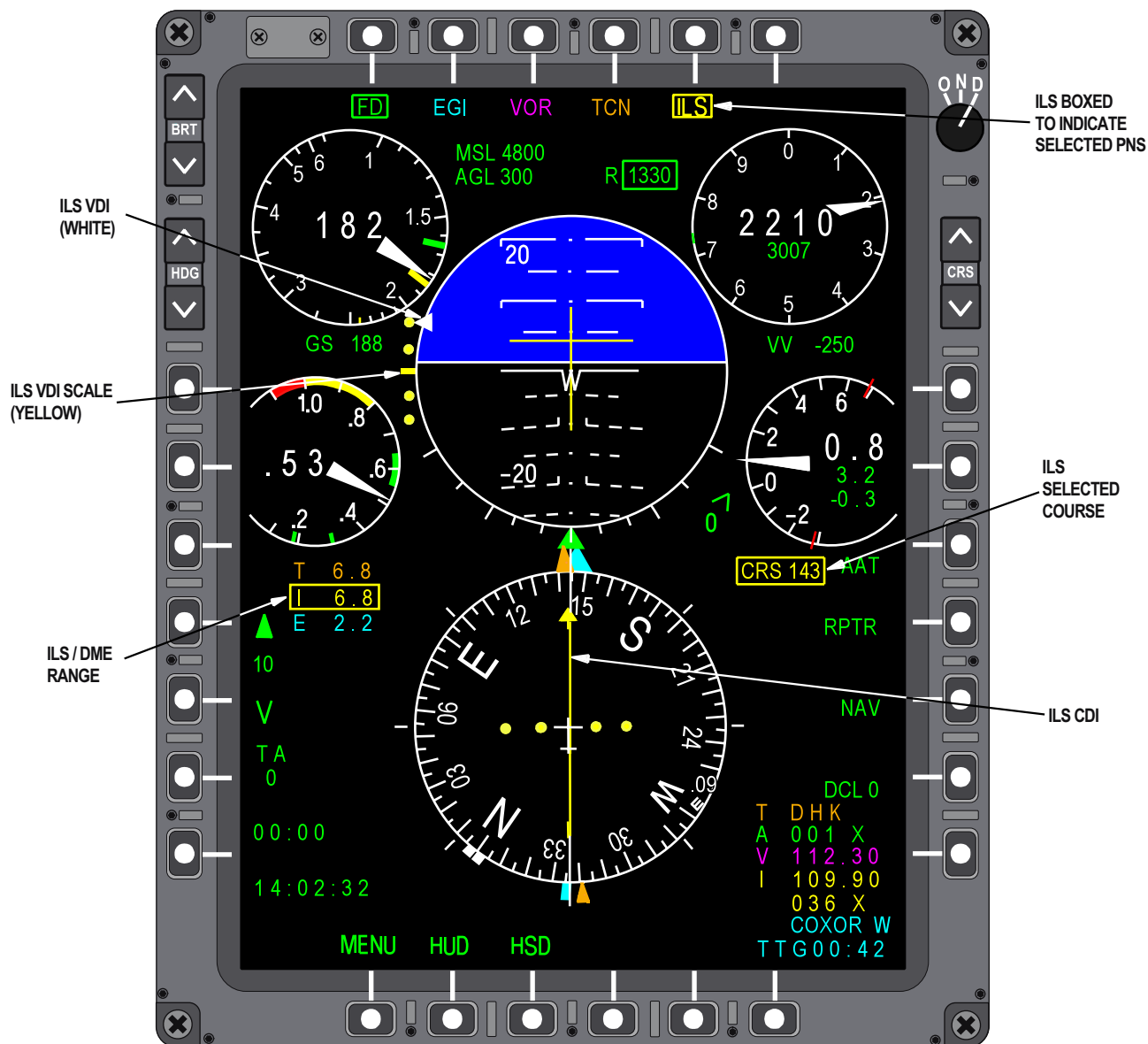

Figure 1-235. MFD PFR Display

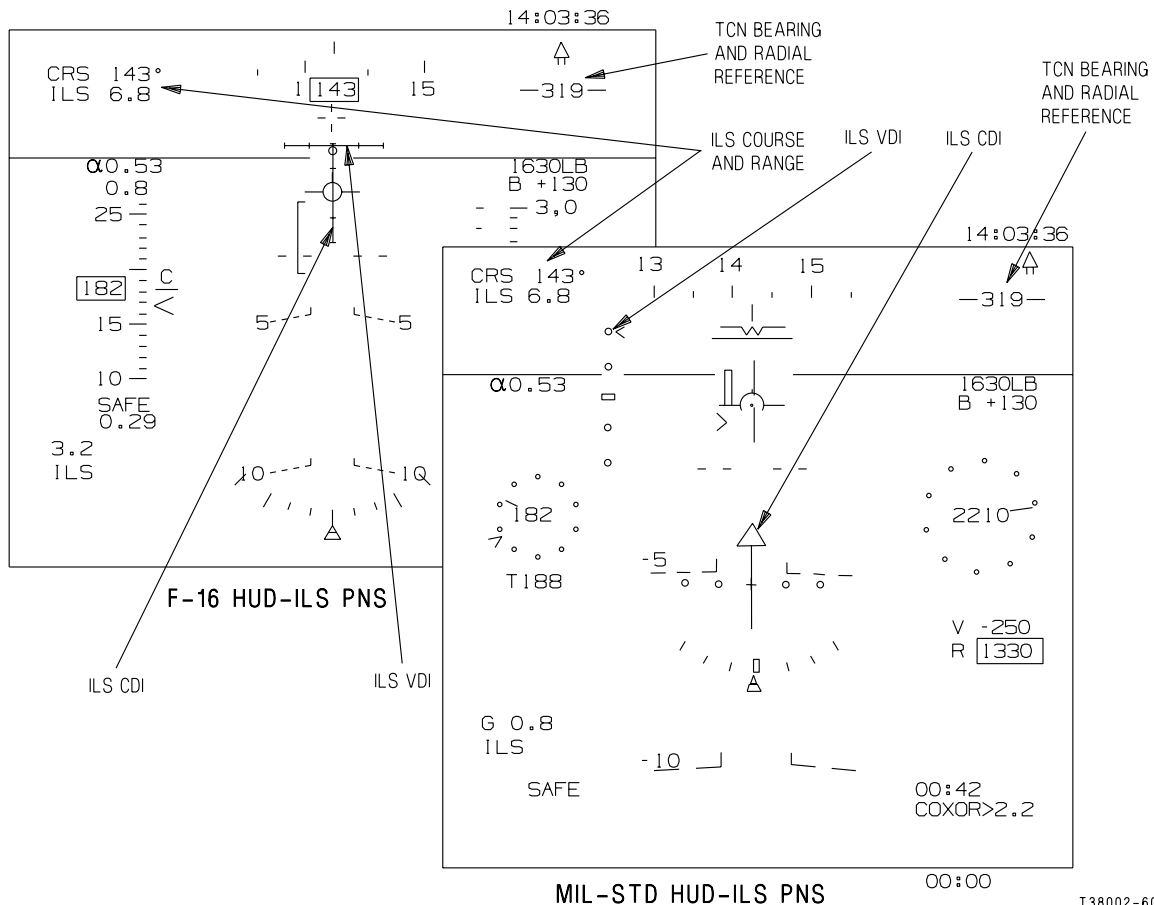

Figure 1-236. HUD ILS (PNS)

ILS CONTROLS

ILS POWER CONTROL

The VOR/ILS is powered only when the AAP Backup Mode Control Knob is out of the OFF position and the NAV Backup Control Panel Mode Knob is out of the OFF position. Refer to AVIONICS ACTIVATION PANEL (AAP) and BACKUP CONTROL PANELS, this section.

ILS NORMAL/BACKUP MODE CONTROL

The ILS operates in normal mode when the AAP Backup Mode Control Knob is in the NORM or UHF B/U position. Refer to AVIONICS ACTIVATION PANEL (AAP), this section.

UFCP ILS CONTROLS AND DISPLAYS

UFCP controls and displays used for ILS navigation, Figure 1-237, are as follows:

a. Selection of ILS as the PNS is accomplished on the UFCP NAV Source Sub-Menu Display.

b. The ILS frequency is selected via the UFCP NAV AID Sub-Menu Display. The ILS frequency can also be selected via Window 2 of the UFCP Basic Menu Display when ILS is the PNS.

c. Selection of the ILS range source, either the paired DME or TACAN, is accomplished on the UFCP NAV AID Sub-Menu Display. The channel displayed in Window 4L is the selected range source which is toggled via MOSB UR-4

d. Selection and display of the selected ILS course is accomplished on the UFCP SET Key Display.

e. Selection and display of the FD on/off status is accomplished on the UFCP NAV Sub-Menu Display. FD default is on and an asterisk is displayed.

MFD ILS CONTROLS AND DISPLAYS

MFD controls and displays used for ILS navigation, Figure 1-237, are as follows:

a. Selection of ILS as the PNS is accomplished via MOSB MT-5 on MFD displays in all Master Modes.

T.O. 1T-38C-1

GBN

ILS (MOSB MT-5) is boxed when selected as the PNS.

b. Selection of the desired ILS course is accomplished via the CRS Rocker Switch with display of the selected course (colored Yellow) in the CSW.

c. When ILS is the PNS, FD is defaulted on and can be toggled on/off with MOSB MT-1. FD (MOSB MT-1) is boxed when selected.

CHANGING THE ILS FREQUENCY

The ILS frequency is selected/changed via the UFCP NAVAID Sub-menu Display, Figure 1-237. Once a new frequency is entered, the DME automatically updates with the paired DME.

When the range source is TACAN rather than the ILS-paired DME, the TACAN range data can be associated with ILS via the UFCP NAVAID Sub-Menu Display, Window 4L, UL-4 (toggle TACAN versus ILS-paired by pressing UR-4).

AUDIO CONTROL PANEL (ACP)

The ACP NAV Audio Control Switch allows control for monitoring of the ILS and DME station Morse code. Refer to AUDIO CONTROL PANEL (ACP), this section.

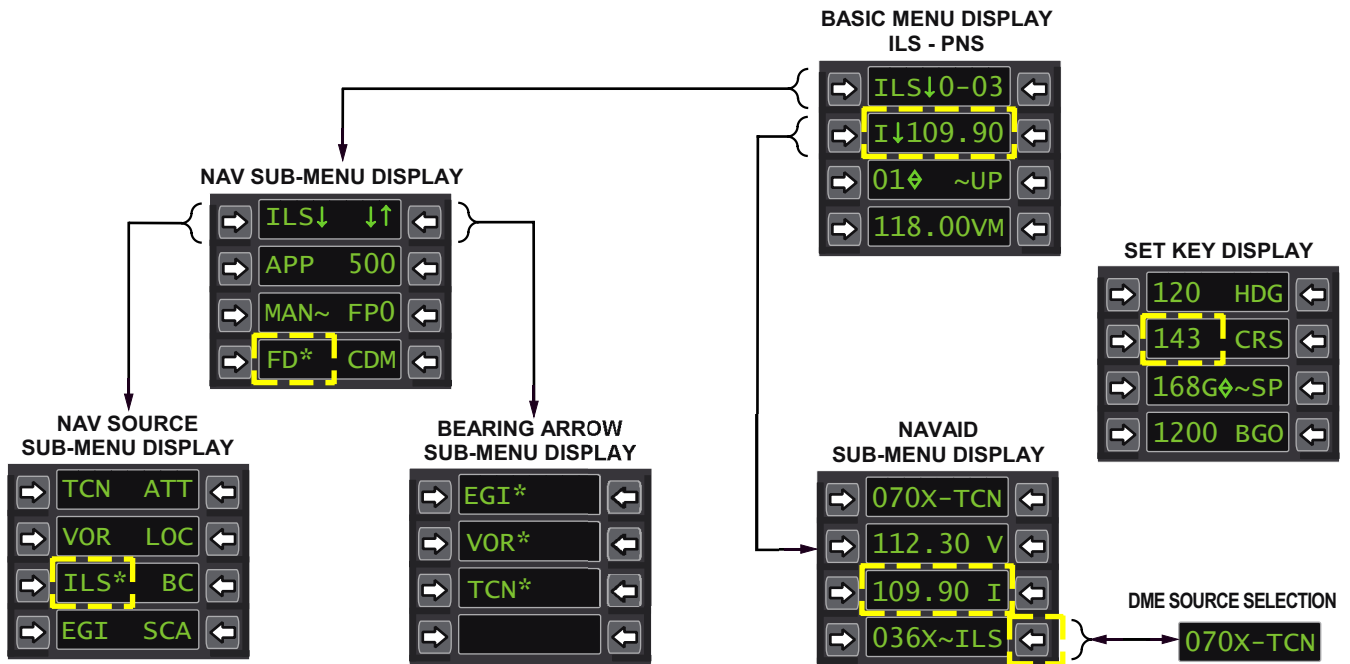

NOTE

VOR BEARING POINTERS ARE NOT DISPLAYED WHEN ILS IS THE PRIMARY NAVIGATION SOURCE.

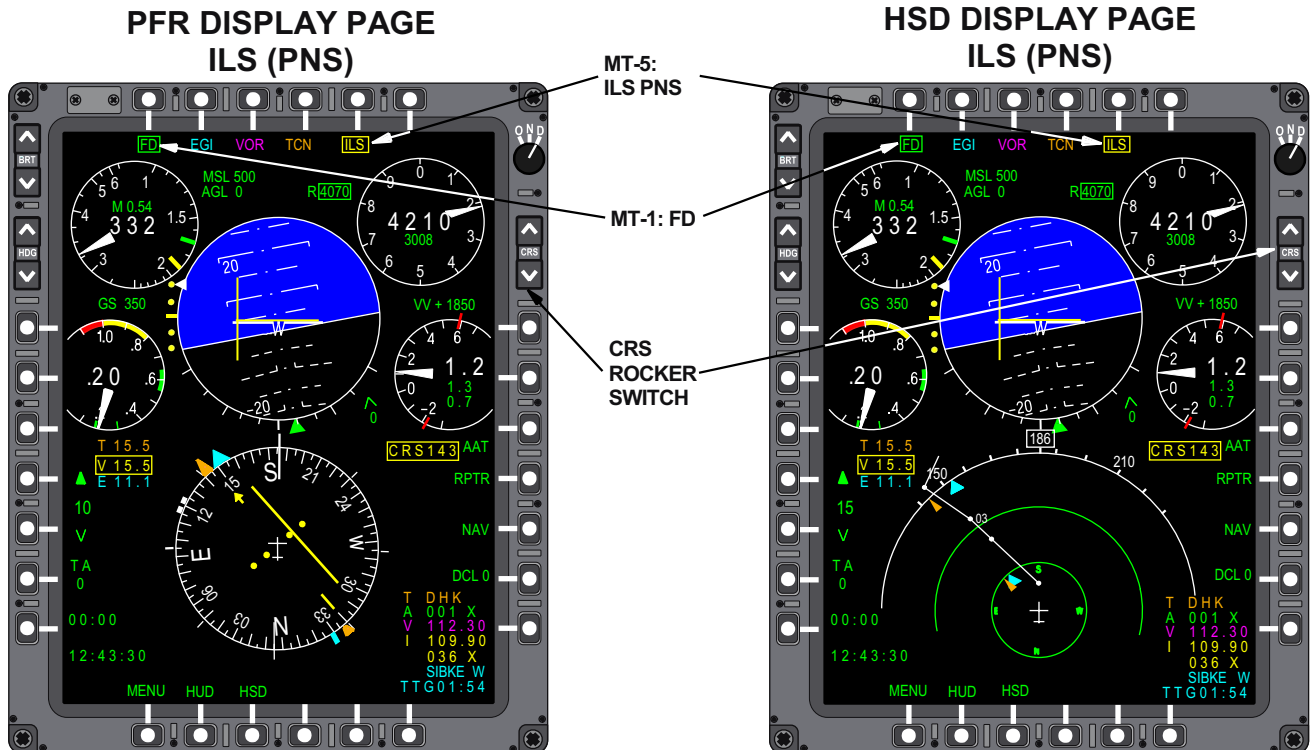

Figure 1-237. UFCP/MFD ILS Controls and Displays

T.O. 1T-38C-1

GBN

ILS NAVIGATION

To conduct ILS navigation, the selected PNS must be ILS, LOC, or BC. When selected and receiving a valid signal, the ILS raw data is displayed on the MFD at all times and on the HUD when in Nav Master Mode.

ILS/DME DISPLAYS

ILS/DME navigation displays for the HUDs, UFCP, and PFR Display are shown in Figure 1-239.

ILS COURSE SELECTION

When ILS is selected, the initial course displayed in the CSW is the previous system course. It can be manually selected using either the CRS Rocker Switch or the UFCP SET Key Display, window 2L, Figure 1-237.

ILS MFD/HUD CDI DATA DISPLAY

Each dot of CDI/VDI deflection represents $\frac{1}{2}$ localizer/glideslope deflection. Although two dots represent full scale localizer/glideslope deflection, the CDI is capable of extending beyond the second dot to 120% of full scale localizer deflection.

The FD continues to display a relative steering command when the aircraft is outside two dots deflection, but still receiving a valid LOC/GS signal. FD steering is displayed on the HUD (NAV Master Mode only) and MFD (all Master Modes on the EADI) to intercept the selected course and glideslope.

If the ILS does not receive the localizer or GS signal:

a. F-16 HUD raw data - When glideslope or localizer is not received, the horizontal bar is dashed and centered. If localizer is not received, both the horizontal and vertical bars are dashed and centered.

b. F-16 HUD FD - When glideslope is not received, the vertical tic is removed and only bank steering is provided. If localizer is not received, the whole FD symbol is removed from display.

c. MIL-STD HUD raw data - When glideslope is not received, the VDI pointer is removed, but scaling remains displayed. If the localizer signal is not received, the CDI bar and VDI pointer are removed from the display.

d. MIL-STD HUD FD - When glideslope is not received, the horizontal bar is removed. If the localizer signal is not received, both horizontal and vertical bars are removed from the display.

e. MFD raw data - When glideslope is not received, the VDI pointer is removed, but scaling remains displayed. If the localizer signal is not received, the CDI bar and glideslope pointer are removed from the display.

f. MFD FD - If glideslope is not received, the pitch bar is removed from the display. If localizer is not received, the pitch and bank bars are removed from the display.

NAVIGATION USING THE LOCALIZER AND BACK COURSE

When ILS is the selected PNS, pressing MOSB MT-5 again selects Localizer (LOC), Figure 1-240 as the PNS. LOC can also be selected via UFCP NAV Source Sub-Menu Display, by pressing UR-2.

When LOC is selected, BC (Back Course) is the display title for MOSB MT-6. Pressing MT-6 selects BC, Figure 1-241 as the PNS. BC can also be selected via the UFCP NAV Source Sub-Menu Display by pressing UR-3 or NWS PNS rotary. When LOC is selected, the FD pitch steering is removed from the HUD and MFD.

When BC is selected, the glideslope raw data and scale are removed along with FD pitch steering. The CDI on the EHSI and HUD provide correct relative position and steering with the BC signal as long as the LOC approach front course is entered in the CSW.

MARKER BEACON LIGHT

A Marker Beacon Light is installed on the left side of the main instrument panel (next to the MFD) in both cockpits. The Marker Beacon Lights flash to signify marker passage in accordance with marker type (outer, middle, or inner). Along with the light, the ACP has a setting for monitoring the beacon identifiers at passage; refer to AUDIO CONTROL PANEL (ACP), this section.

ILS NAVIGATION BACKUP OPERATIONS

When the NAV Backup Control Panel is active and controlling navigation frequency selection, the aircrew must select an ILS frequency on the NAV Backup Control Panel, Figure 1-238, to conduct ILS operations. The system tunes the matched pair for DME reference. Refer to BACKUP CONTROL PANELS, this section.

When in Nav Backup (MDP operational with AAP Backup Mode Control Knob in NAV B/U or BOTH), ILS navigation backup operations require the following:

- a. Select the ILS frequency on the NAV Backup Control Panel.
- b. Select ILS/LOC/BC as the PNS on the MFD or UFCP NAV Source Sub-Menu Display (ILS frequency must be tuned first and ILS is not a PNS option when the VOR/ILS is tuned to a VOR frequency).
- c. Set the desired ILS course via the CRS Rocker Switch or UFCP SET Key Display.

Navigation displays are provided on the MFD, Figure 1-237, and HUD the same as in normal mode with the following exceptions:

- a. The latent VOR frequency from NAV Data block line 3 is removed. Line 4 continues to display the tuned ILS frequency.
- b. NAV Data block line 5 only displays the ILS-paired DME channel.

c. MFD ILS range source is always the ILS paired DME range.

d. HUD ILS range source is always the A/G TACAN.

When the MDP is failed or off, NAV Backup is automatically selected, the MFD reverts to MFD Backup mode, and the audio is controlled by the FCP ACP NAV Audio Control Switch. ILS navigation backup operations require the following:

- a. Select the ILS frequency on the NAV Backup Control Panel.
- b. Select ILS as the PNS on the MFD Backup Display.
- c. Set the desired ILS course via the MFD CRS Rocker Switch.

Navigation displays are limited to those provided on the MFD Backup Display. Refer to MFD BACKUP DISPLAY, this section.

NAV BACKUP CONTROL PANEL



MFD BACKUP DISPLAY



Figure 1-238. ILS Navigation Backup Operations

T38002-606-1-020

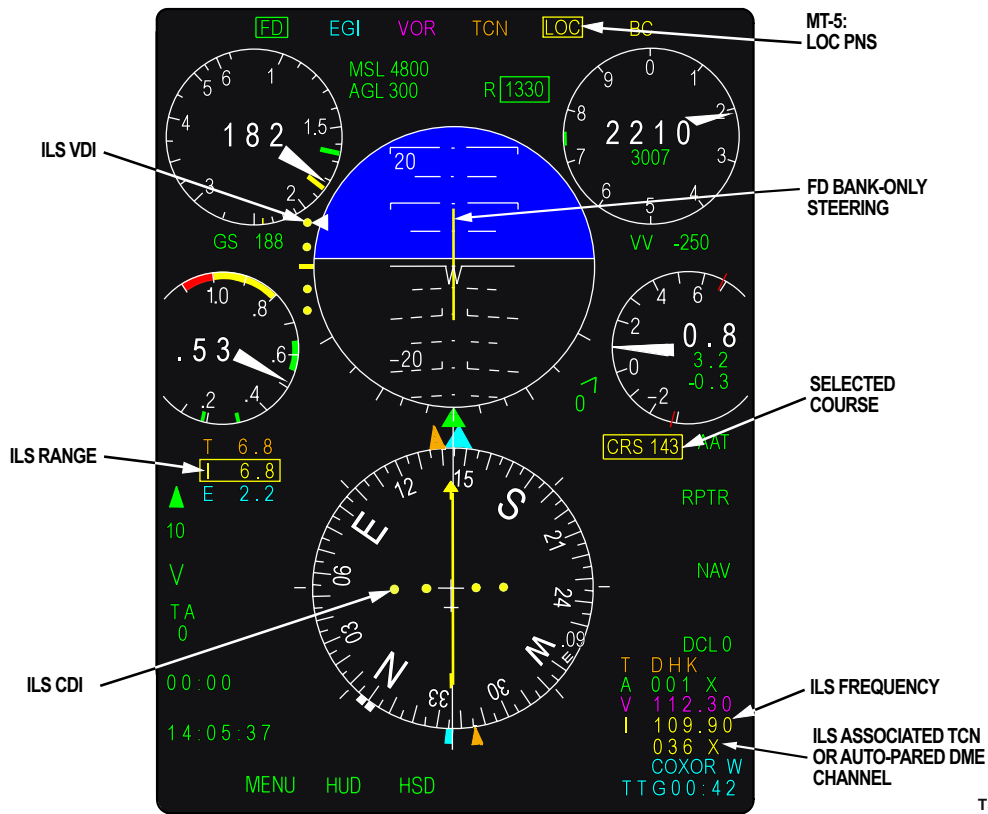
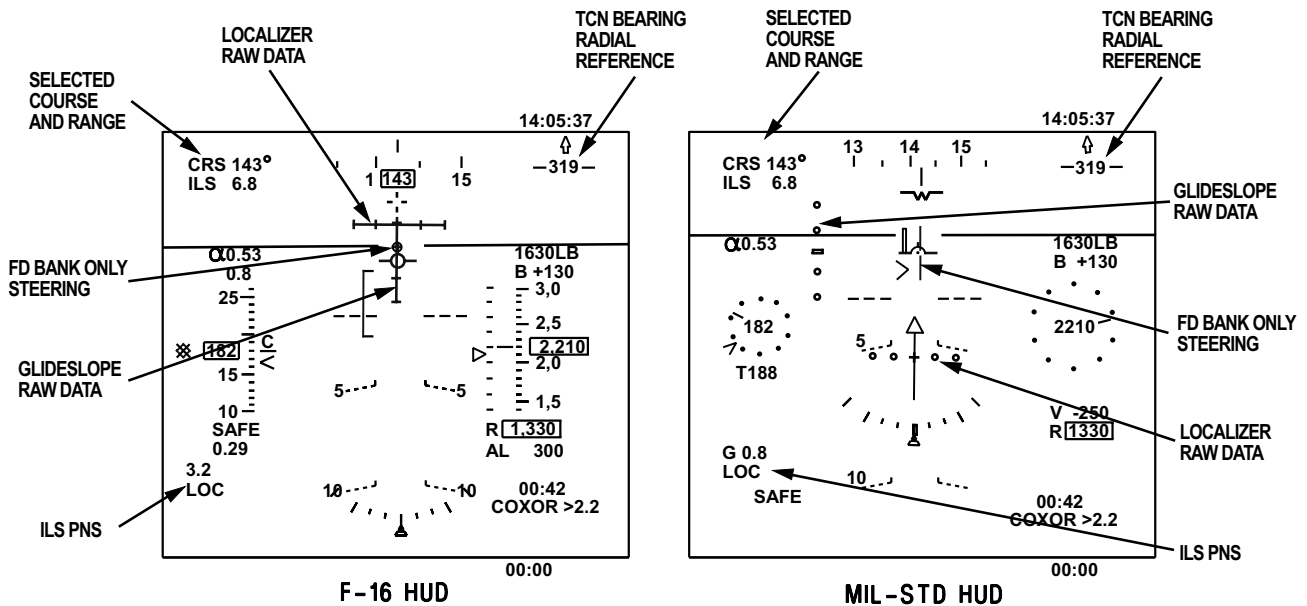

T38002-604-1-020

Figure 1-240. ILS Navigation Displays (LOC)

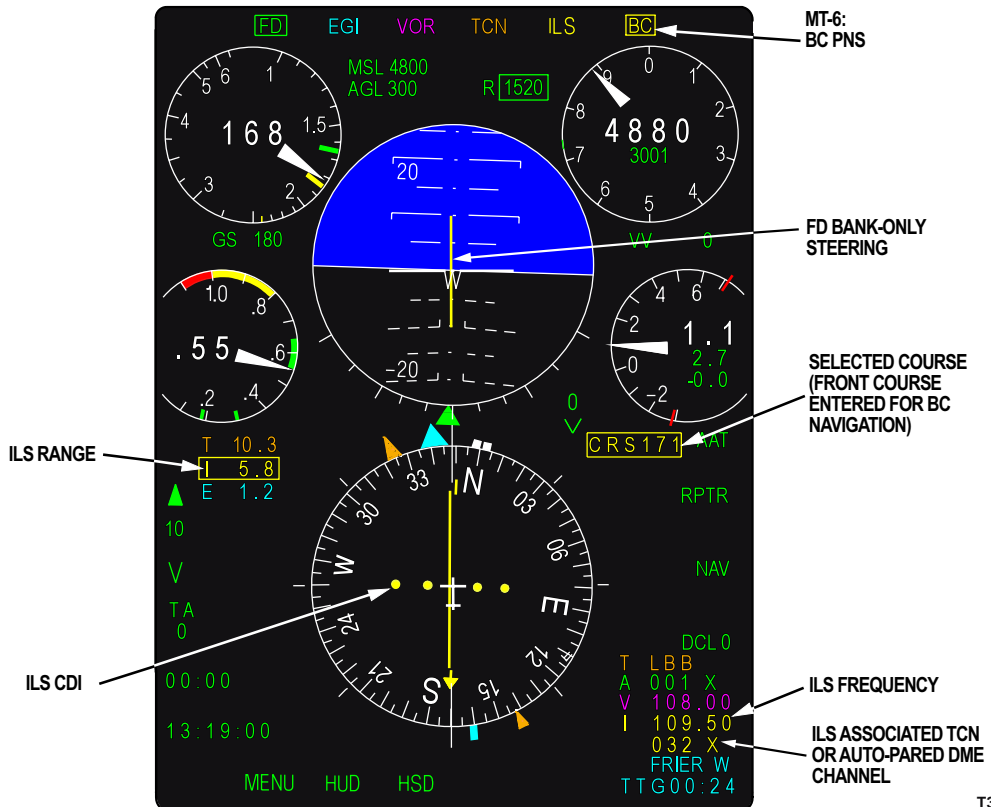
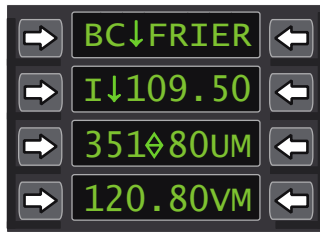
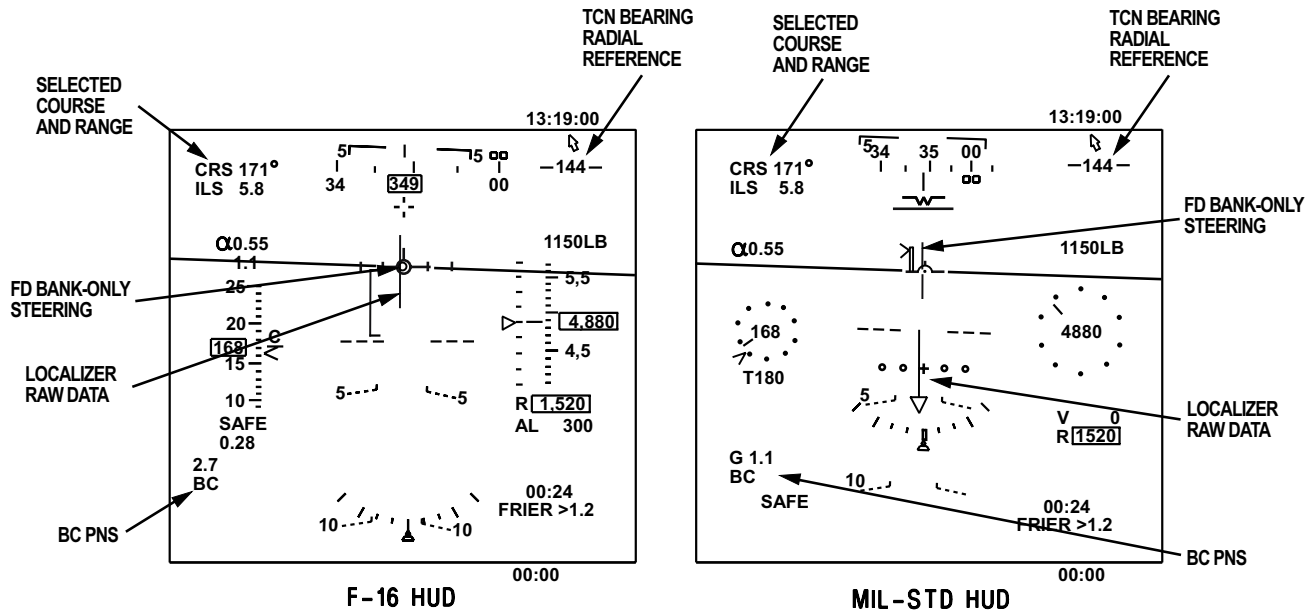

T38002-605-1-020

Figure 1-241. ILS Navigation Displays (BC)

TACAN DISPLAYS

TACAN information displays include the following:

a. UFCP NAVAID Sub-Menu Display, Figure 1-242 - The selected TACAN channel for A/G is displayed (### X/Y ~ TCN) in Window 1. Pressing UR-1 toggles to display/edit the TACAN A/A channel selection display (### X/Y ~ AAT) in Window 1.

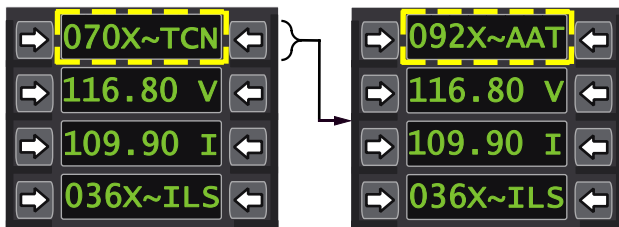

T38002-607-1-020

Figure 1-242. UFCP NAVAID Sub-Menu Display

b. NAV Data Block, Figure 1-243, (Lines 1 and 2, colored Orange and Green, respectively) - The tuned TACAN (A/G) channel, line 1, is displayed (T ### X/Y) and the TACAN (A/A) channel, line 2, displayed (A ### X/Y). The NAV Data Block is displayed on both PFR and HSD but may be removed when DCL 2 (MR-6) is selected.

c. When the TACAN is receiving a valid station signal, the following MFD displays are also presented:

- (1) EHSI and HSD - The orange TACAN Bearing Pointer is displayed, Figure 1-247.

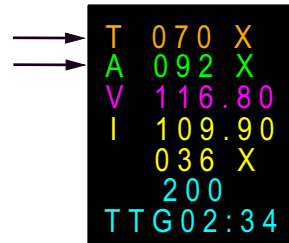

T38002-608-1-020

Figure 1-243. MFD NAV Data block

- (2) Range Data Block - TACAN range window is colored orange and displays DME data, Figure 1-247.
- (3) TACAN (A/G) channel, MFD NAV Data Block line 1, is replaced with station identifier (this may take up to 2 minutes).

When the TACAN is PNS, the following displays are also presented:

a. The UFCP displays TACAN data, Figure 1-244, as follows:

- (1) The Basic Menu Display has T↓ ### X/Y presented in Window 2.
- (2) The NAV Source Sub-Menu Display has an asterisk after TCN in Window 1L.

b. The MFD, Figure 1-245, displays are as follows:

- (1) TCN (MOSB MT-4) is boxed.
- (2) TCN Range Data Block (line 1), is boxed.
- (3) CDI and CSW - Both are colored orange.

UFCP BASIC MENU DISPLAY

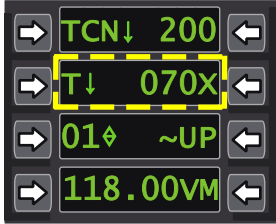

UFCP NAV SOURCE SUB-MENU DISPLAY



T38002-609-1-020

Figure 1-244. UFCP TACAN Display

c. The HUD displays the TACAN Range under the CRS Display in the upper left corner, Figure 1-246, in NAV Master Mode only. TCN is the prefix for this range.

d. When the TACAN is receiving a valid station signal, the HUD CDI displays the deviation from the selected course to/from the TACAN station.

e. When the TACAN is receiving a valid station signal, the HUD Bearing Arrow/Radial Readout is referenced to the TACAN station.

f. FD is defaulted off, but can be selected for display on the HUD and the EADI. Refer to FLIGHT DIRECTOR LOGIC AND USAGE, this section.

NOTE

The HUD CDI and TCN Course and Range are not displayed in A/A or A/G Master Modes.

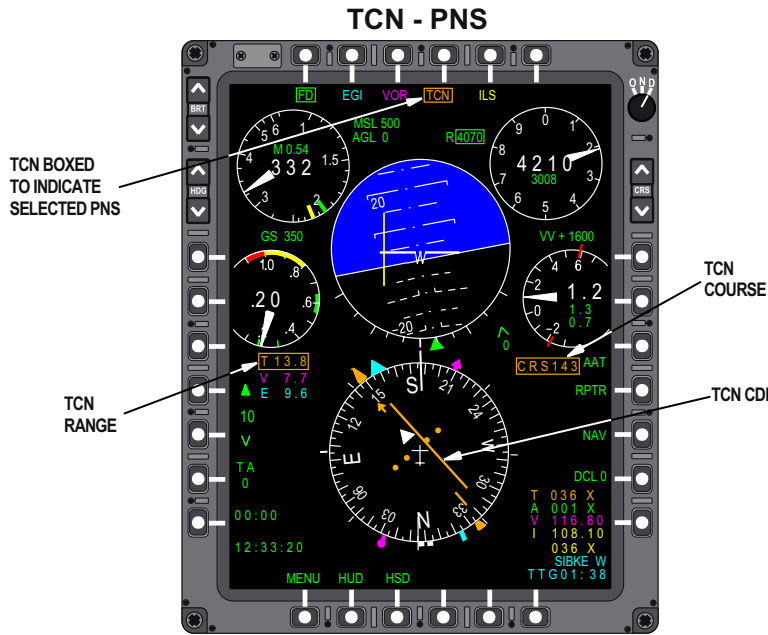

Figure 1-245. MFD PFR Display Page

T38002-610-1-020

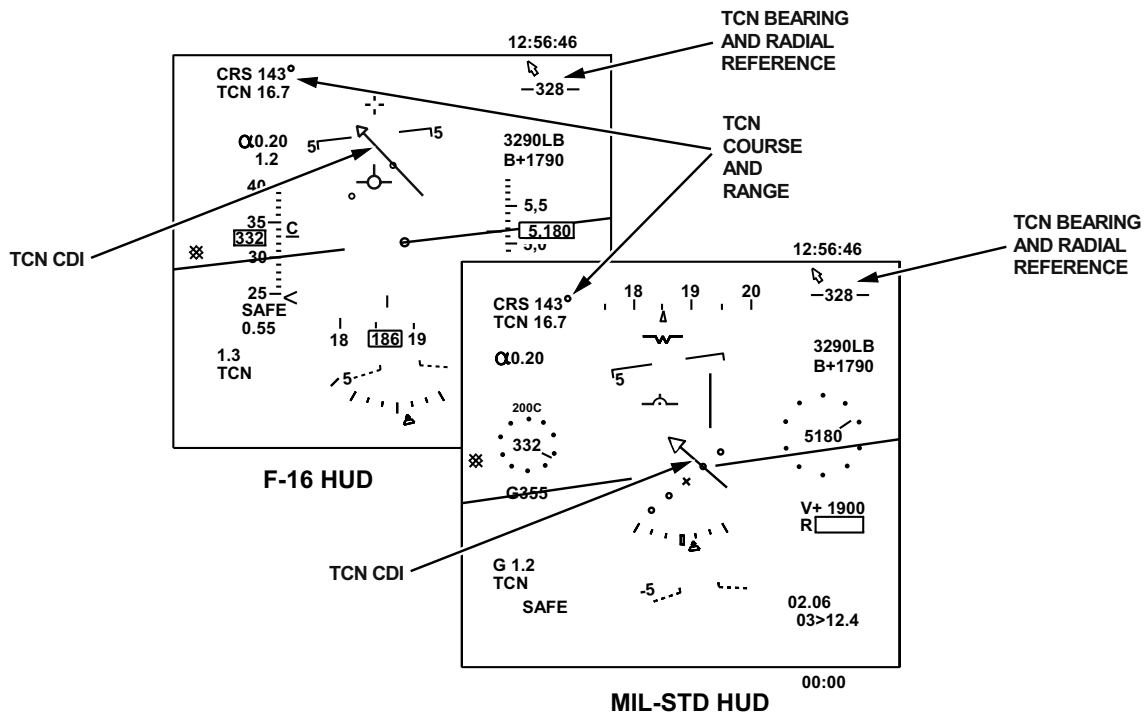

Figure 1-246. HUD TCN (PNS)

T38002-615-1-020

TACAN CONTROLS

TACAN POWER CONTROL

The TACAN is powered in both normal and backup modes when the TACAN Backup Control Panel ON/OFF switch is in the ON position. Neither the AAP Backup Mode Control Knob nor the NAV Backup Control Panel affect TACAN power control. Refer to BACKUP CONTROL PANELS, this section.

TACAN NORMAL/BACKUP MODE CONTROL

TACAN is operated in normal mode when the AAP Backup Mode Control Knob is in the NORM or UHF B/U position. The TACAN is operated in Nav Backup Mode when the switch is in any other position including OFF. Refer to AVIONICS ACTIVATION PANEL (AAP), this section.

UFCP TACAN CONTROLS

UFCP controls and displays used for TACAN navigation, Figure 1-247, are as follows:

- Selection of TCN as the PNS is accomplished on the UFCP NAV Source Sub-Menu Display.
- The TACAN channel is selected via the UFCP NAVAID Sub-Menu Display. The TCN channel can also be selected via Window 2 of the UFCP Basic Menu Display when TCN is the PNS.
- Selection of the TACAN course is accomplished on the UFCP SET Key Display.
- Selection and display of the FD on/off status is accomplished on the UFCP NAV Sub-Menu Display. An asterisk is presented when FD is on.
- Selection of the TCN Bearing Pointer for PFR and HSD displays is accomplished on the UFCP Bearing Arrow Sub-Menu Display. An asterisk is

T.O. 1T-38C-1

GBN

presented when bearing arrow display is enabled. When disabled, the MFD TCN Bearing Arrow and Range Window are removed from the display except when TCN is selected as the PNS.

MFD TACAN CONTROLS

MFD controls used for TACAN navigation, Figure 1-247, are as follows:

a. Selection of TCN as the PNS is accomplished via MOSB MT-4 on MFD displays in all Master Modes. TCN (MOSB MT-4) is boxed when selected as the PNS.

b. Selection of the desired TCN course is accomplished via the CRS Rocker Switch with display of the selected course (colored orange) in the CSW.

c. When TCN is the PNS, FD is defaulted off and can be toggled on/off with MOSB MT-3. FD (MOSB MT-1) is boxed when selected.

CHANGING THE TACAN CHANNEL

The TACAN channel is changed via the UFCP NAVAID Sub-Menu Display, Figure 1-247. Once a new channel (A/G or A/A) is entered, the UFCP and MFD NAV Data Block are updated.

AUDIO CONTROL PANEL (ACP)

Controls on the ACP allow the aircrew to monitor station Morse code identifier using the NAV Audio Control Switch. Refer to AUDIO CONTROL PANEL (ACP), this section.

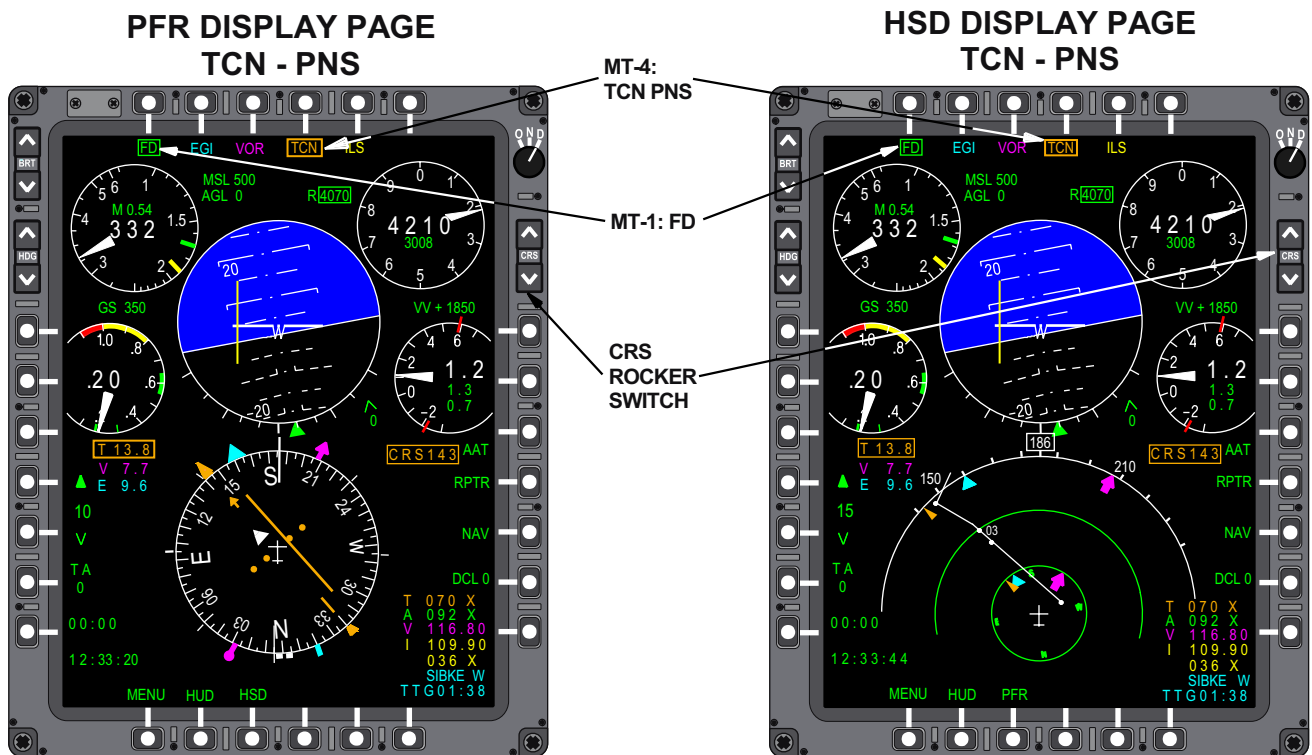
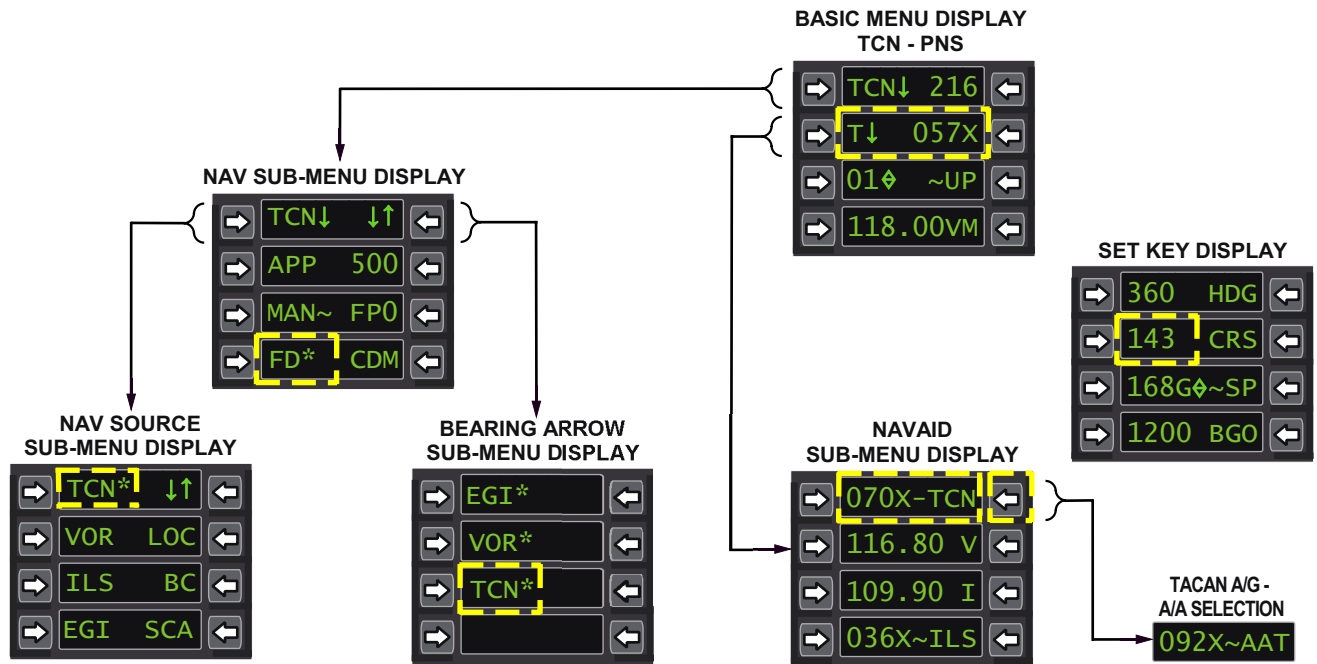

Figure 1-247. TACAN Controls and Displays

T38002-614-1-021

T.O. 1T-38C-1

GBN

TACAN NAVIGATION

To conduct TACAN navigation, the PNS must be TCN. When receiving a valid signal, TCN raw data is displayed on the MFD at all times and on the HUD when in NAV Master Mode.

TACAN DISPLAYS

TCN navigation displays for the HUD, UFCP, and PFR displays are shown in Figure 1-248.

TACAN COURSE SELECTION

When TCN is selected, the initial course displayed in the CSW is the previous system course. It can be manually selected using either the CRS Rocker Switch or the UFCP SET Key Display, window 2L, Figure 1-247.

NOTE

Selection of the EGI as the PNS can result in course updates which may not be obvious to the aircrew. Therefore, when TCN is selected as the PNS following EGI, the desired course must be verified.

TACAN MFD/HUD CDI DATA DISPLAY

Each dot of CDI deflection represents 5° off the selected course. Full scale deflection represents 12° or more off of the selected course.

TACAN NAVIGATION BACKUP OPERATIONS

When the TACAN Backup Control Panel is active and is controlling navigation channel selection, aircrew must select a TACAN channel and designate

A/G or A/A on the TACAN Backup Control Panel to conduct TACAN operations. Refer to BACKUP CONTROL PANELS, this section.

When in Nav Backup (MDP operational with AAP Backup Mode Control Knob in NAV B/U, BOTH, or OFF), TACAN navigation backup operations, Figure 1-249, require the following:

- a. Select a TACAN channel and A/G on the TACAN Backup Control Panel.
- b. Select TCN as the PNS on the MFD or UFCP NAV Source Sub-Menu Display.
- c. Select the desired TACAN course via the CRS Rocker Switch or UFCP SET Key Display.

Navigation displays are provided on the MFD, Figure 1-248, and HUD the same as in normal mode except the AAT channel from NAV Data block line 2 is removed.

When the MDP is failed or off, Nav Backup is automatically selected, the MFD reverts to MFD Backup mode, and the audio is controlled by the FCP ACP NAV Audio Control Switch. TACAN navigation backup operations require the following:

- a. Select a TACAN channel on the TACAN Backup Control Panel.
- b. Select TCN as the PNS on the MFD Backup Display.
- c. Select the desired TACAN course via the CRS Rocker Switch.

Navigation displays are limited to those provided on the MFD Backup display, refer to MFD BACKUP DISPLAY, this section.

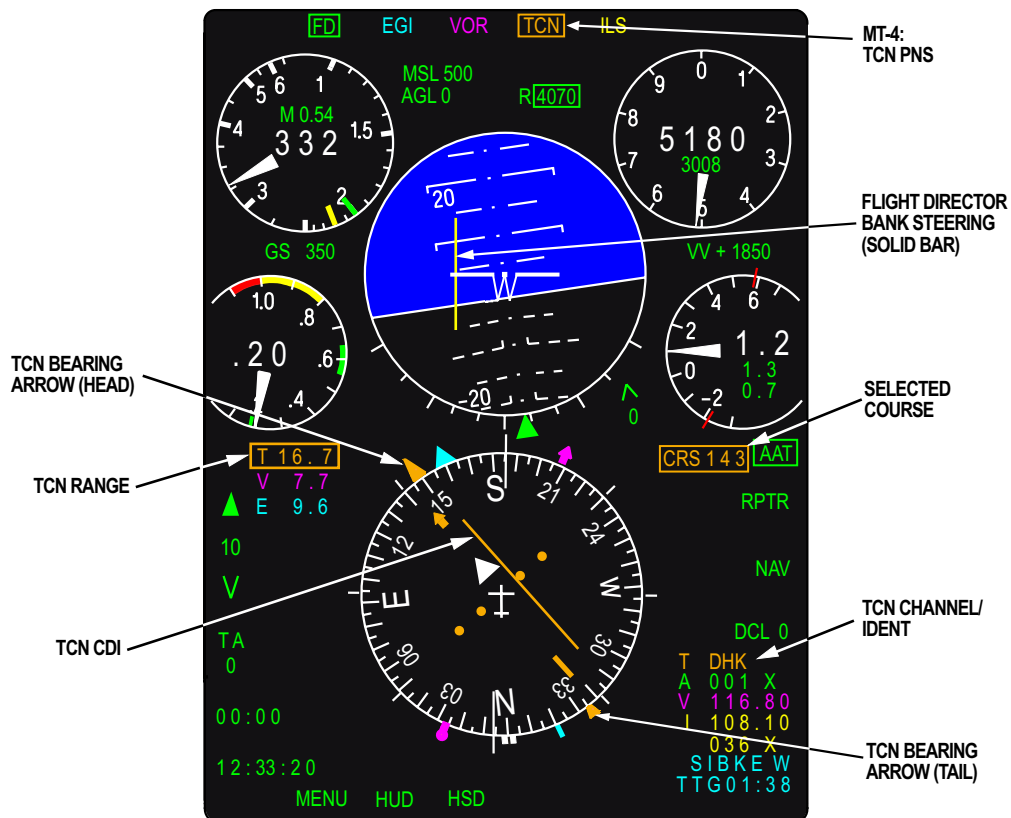
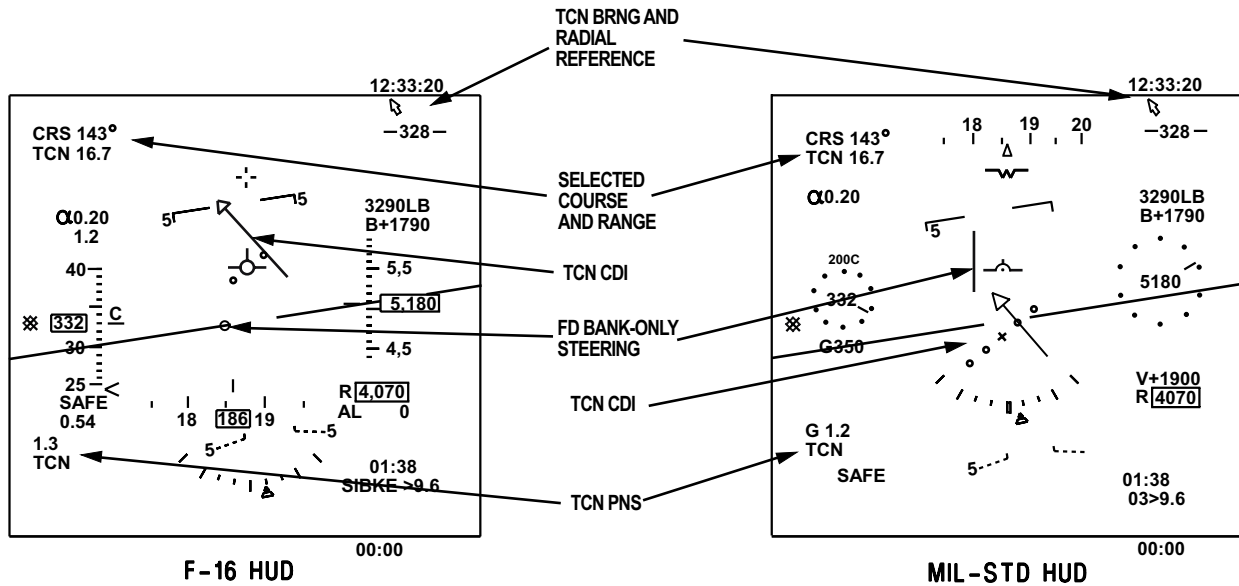

Figure 1-248. TACAN Navigation Displays (AG)

T38002-613-1-020



TACAN BACKUP CONTROL PANEL
(TCN CHANNEL SELECTED)



MFD BACKUP DISPLAY

Figure 1-249. TACAN Navigation Backup Operations

AIR-TO-AIR TACAN (AAT)

Select AAT (MOSB MR-3) to transmit/receive range-only information to/from cooperatively tuned airborne platforms.

Deselecting AAT will return the TACAN to air-to-ground mode. Control of AAT (when not in Nav Backup Mode) is as follows:

a. AAT is manually selected or deselected via MOSB MR-3 PFR or HSD, or UR-1 on the UFCP Nav Source Sub-Menu Display, regardless of PNS. AAT is defaulted off at MDP powerup.

b. AAT is selectable with any PNS. When ILS/LOC/BC is selected as PNS, AAT is automatically deselected.

c. Pressing MOSB MT-4 when TCN is already boxed deselects AAT.

NOTE

AAT is selectable with any PNS. If ILS/LOC/BC is selected as PNS, AAT is automatically deselected.

Air to Air TACAN Range

When the TACAN receiver reports it is in A/A mode, the AAT range is displayed in the MFD Range Data Block and the lower right corner of the HUD, Figure 1-250. If there is no range reception, the prefix A on the MFD and AAT on the HUD are displayed, but the range is blank.



Under dynamic conditions (i.e., high rates of closure or separation), displayed AAT ranges may differ greatly from actual ranges between aircraft.

NOTE

When AAT is selected, VOR/ILS range data is removed from line 2 of the Range Data Block.

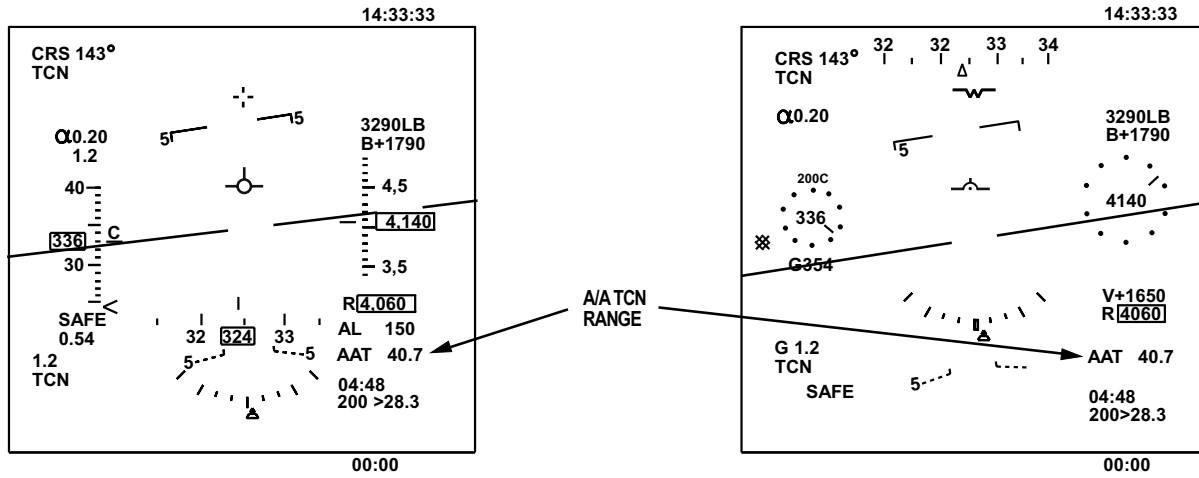

T38002-611-1-021

Figure 1-250. AAT Displays

NAVIGATION TUNING

NORMAL TUNING

The MDP limits tuning combinations between navigation receivers.

When TCN is the PNS, the VOR/ILS is tuned to the VOR frequency, DME is tuned to the channel auto-paired to the VOR, TACAN is tuned to the TCN channel.

When EGI is the PNS, the VOR/ILS is tuned to the VOR frequency, DME is tuned to the channel auto-paired to the VOR, TACAN is tuned to the TCN channel.

When VOR is the PNS, the VOR/ILS is tuned to the VOR frequency, DME is tuned to the channel auto-paired to the VOR, TACAN is tuned to the TCN channel.

When ILS is the PNS, the VOR/ILS is tuned to the ILS frequency, DME is tuned to the channel auto-paired to the ILS, TACAN is tuned to the TCN channel. TACAN is initially forced to air-to-ground, but can be reselected via AAT (MOSB MR-3).



When tuning the TCN or DME, as much as 2 minutes is required before the system provides audio identification.

The allowable combinations are outlined in the Navigation Receiver Tuning table below:

Primary Navigation Source	VOR/ILS Tuning	DME Tuning	TACAN Tuning
TCN	VOR Freq	VOR Paired	TCN Chan
¹ EGI	VOR Freq	VOR Paired	³ TCN or AAT Chan
VOR	VOR Freq	VOR Paired	³ TCN or AAT Chan
² ILS	ILS Freq	ILS Paired	⁴ TCN Chan
NOTES ¹ EGI includes PNS of EGI or SCA. ² ILS includes PNS of ILS, LOC, or BC. ³ Based on AAT selection at MR-3. ⁴ The TACAN is automatically taken out of air-to-air mode and returned to air-to-ground TACAN channel when ILS is selected as PNS.			

FAILS-TO-TUNE

When the commanded TACAN channel (input via UFCP) fails to tune, the UFCP data entry will continue to flash and the Nav Data block will display only the actual tuned channel (A/A or A/G).

If DME fails to tune, the actual reported channel is not auto-paired with the commanded VOR/ILS frequency. If ILS is the PNS and DME fails to tune, the displays behave as follows:

- a. The actual reported channel is displayed in yellow at window 5 of the Nav Data block.
- b. ILS range on the MFD is displayed (assuming there is signal reception), and the color reflects the selected PNS (yellow).
- c. ILS range is not displayed on the HUD in a DME failed-to-tune condition.

If ILS is not the PNS, the NAV Data block line 5 displays the latent channel as displayed in window 4 of the UFCP NAVAID Sub-menu Display. The NAV

T.O. 1T-38C-1
GBN

Data block provides no indication of a DME fails-to-tune condition unless ILS is the PNS (VOR associated DME is never displayed).

If ILS is not the PNS and the DME failed-to-tune, then no range is displayed on the HUD or MFD (VOR range is blank in Range Block).

When a failed-to-tune condition occurs, the pilot is alerted via the avionics caution on the HUD and MFD and a FAILED- TO- TUNE (PFL) is generated. Refer to PILOT FAULT LIST, Section III.

When the PNS fails to tune, the UFCP Basic Menu Display, window 2 displayed frequency, blinks. The displays listed in Figure 1-251 blink, if the associated sources fail to tune.

FAILED-TO-TUNE SOURCE	NAVAID SUB-MENU
TCN	Window 1 (TCN)
AAT	Window 1 (AAT)
VOR	Window 2
VOR PAIRED DME	N/A
ILS	Window 3
ILS-DME	Window 4 (ILS)
ILS-TCN	Window 1, Window 4 (TCN)

Figure 1-251. UFCP Displays Affected by Failed-To-Tune Condition

BACKUP CONTROL PANELS

BACKUP CONTROL PANELS OVERVIEW

There are three backup control panels installed in the FCP of the T-38C to enable backup navigation and communication control:

- a. NAV Backup Control Panel
- b. TACAN Backup Control Panel
- c. UHF Backup Control Panel

NAV BACKUP CONTROL PANEL

The NAV Backup Control Panel (Figure 1-253), located on the FCP right main instrument panel, tunes the VOR/ILS transceiver when in backup mode. The Mode Knob controls power to the VOR/ILS transceiver in normal and backup operation. Backup VOR/ILS tuning is automatically enabled when the MDP is off or not functioning. For other malfunctions (e.g. UFCP failure, VOR/ILS/DME fails to tune) NAV B/U or BOTH can be manually selected via the FCP AAP Backup Mode Control Knob. The NAV Backup Control Panel display illuminates only in backup mode. When illuminated, the NAV Backup Control Panel provides control of the navigation frequency selection and NAV BACKUP appears in windows 2 and 3 of the UFCP NAVAID Sub-Menu Display, Figure 1-252. NAV Backup Control Panel display brightness is controlled by the INSTRUMENTS Control Knob located on the FCP Lighting Control Panel. The paired DME channel is automatically tuned for the VOR/ILS frequency selected on the NAV Backup Control Panel, with the TACAN Backup Control Panel ON.



Figure 1-252. NAVAID (Backup Mode) Sub-Menu Display

T38002-470-1-020

NOTE

- TACAN Backup Control Panel Power Switch position must be ON, to receive the paired VOR/ILS DME channel.
- The frequency/channel in window 2 of the UFCP Basic Display indicates the reported frequency/channel however UR-2 is inoperative.
- The VOR/ILS reported frequency is displayed on the MFD in both normal and backup mode. Refer to MULTI-FUNCTIONAL DISPLAY (MFD), this section.



T38002-471-1-020

Figure 1-253. NAV Backup Control Panel

Mode Knob

The four-position rotary mode knob has the following functions:

- OFF Deactivates the VOR/ILS receiver and records the last frequencies displayed into the system's nonvolatile memory.
- ON Activates the NAV backup control panel and the VOR/ILS receiver.

T.O. 1T-38C-1

BU CONTROL

RAD Displays the radial from the selected VOR. It is displayed in the Standby Frequency Window below the selected VOR frequency. When localizer is selected, LOC is displayed in the standby window. If no station is tuned, dashes are displayed. Standby frequency selection is inhibited in this mode and the Frequency Transfer button is disabled.

BRG Displays the bearing to the selected VOR. It is displayed in the Standby Frequency Window below the selected VOR frequency. When localizer is selected, LOC is displayed in the standby window. If no station is tuned, dashes are displayed. Standby frequency selection is inhibited in this mode and the Frequency Transfer button is disabled.

NOTE

When RAD or BRG is selected, rotating the Frequency Selector Knobs changes the active frequency.

Frequency Transfer Button

The Frequency Transfer Button is located in the middle of the NAV Backup Control Panel Mode Knob and performs the following functions:

Press

- | | |
|-------------|--|
| <2 Seconds | Exchanges the active and standby frequencies. |
| 2-7 Seconds | Clears the Standby Frequency Display Window; the active frequency is changed using the frequency selector knobs. |
| >7 Seconds | Sets the active frequency to 108.00 MHz. |

Frequency Selector Knobs

The NAV Backup Control Panel Frequency Selector Knob rotates to display the required frequency in the standby frequency window.

Outer Frequency Selector Knob Tunes frequencies in whole MHz digits from 108 to 117. Clockwise direction increases and counter-clockwise decreases the frequency selection.

Inner Frequency Selector Knob Tunes frequencies in fractional MHz digits from .00 to .95 MHz in increments of .05 MHz. Clockwise direction increases and counter-clockwise decreases the frequency selection.

Frequency Windows

Active Frequency Window

Displays the current operating frequency.

Standby Frequency Window (Scratchpad)

The displayed data is dependent on the mode knob setting:

- ON - Indicates the standby frequency.
- RAD - Indicates radial from VOR station in degrees.
- BRG - Indicates bearing to VOR station in degrees.

NOTE

- Radial and bearing indications require sufficient VOR reception, otherwise three dashes are displayed.
- The Standby Frequency Window displays the following internal failures upon occurrence:

- (1) FAIL 1 is displayed for Nav Receiver failure.

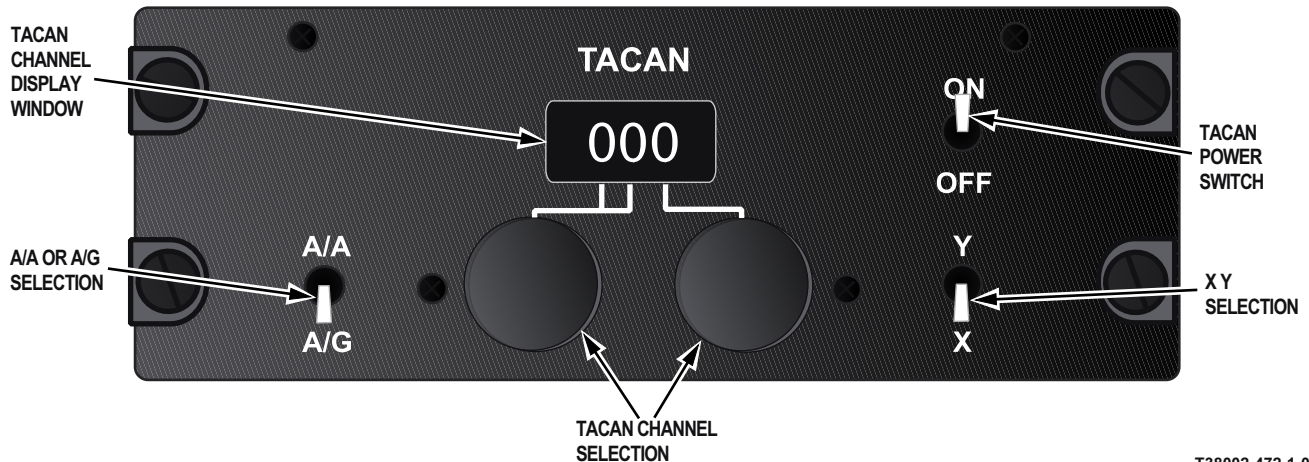

Figure 1-254. TACAN Backup Control Panel

T38002-472-1-020

- (2) FAIL 2 is displayed for Glideslope Receiver failure.
- (3) FAIL 3 is displayed for Nav Converter failure.
- (4) FAIL 4 is displayed for Nonvolatile Memory failure.

These indications are the result of a continual system self-test, and indicate that maintenance is required before the system may be used.

TACAN BACKUP CONTROL PANEL

The TACAN Backup Control Panel, Figure 1-254, is located in the FCP on the left console near the base of the left instrument panel. The TACAN Power Switch controls power to the TACAN in normal and backup operation. Under normal operating conditions, the TACAN Backup Control Panel is active when the AAP Backup Mode Control Knob is in OFF, NAV B/U or BOTH. When the MDP is off or failed, the TACAN Backup Control Panel is active when the AAP Backup Mode Control Knob is in any position. When active, the TACAN Backup Control Panel provides tuning in the A/A and A/G X/Y modes. Panel lighting is controlled via the CONSOLE Control Knob on the Lighting Control Panel.

UHF BACKUP CONTROL PANEL

UHF backup mode is controlled via the UHF Backup Control Panel, Figure 1-255, which is located on the FCP right main instrument panel. The UHF Backup Control Panel Power Knob position must be out of OFF for the UHF to work in normal or backup modes. When the MDP is off or fails, the UHF automatically

enters backup mode. Manual selection for backup control of the UHF radio is done by selecting UHF B/U or BOTH on the FCP AAP Backup Mode Control Knob. The frequency in Window 3 of the UFCP Basic Menu Display and Window 2 of the COM Key Display is replaced with OFF. The UHF reported frequency on the MFD COMM Data Block is removed and OFF is displayed.

Display brightness for the UHF Backup Control Panel is controlled by the INSTRUMENTS Control Knob located on the FCP Lighting Control Panel.

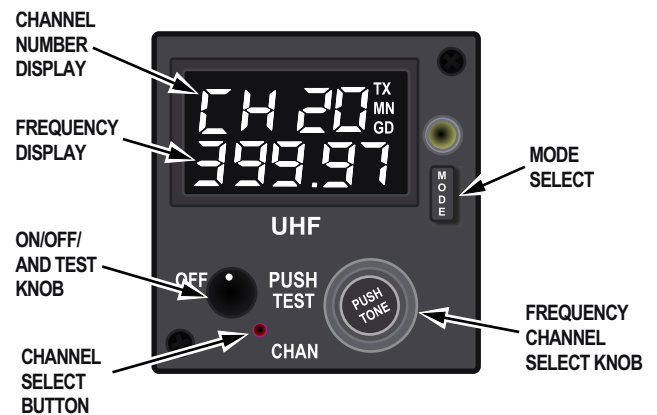

Figure 1-255. UHF Backup Control Panel

T38002-473-1-020

T.O. 1T-38C-1

BU CONTROL

When the UHF Backup Control Panel is activated, the channel, mode, and frequency displays illuminate and display the last settings entered.

NOTE

When setting up the Backup UHF Radio, after the UHF backup frequency or channel has been changed, the AAP Backup Mode Control Knob must be left in UHF B/U or BOTH for 3 seconds before returning to NORM to allow the radio to tune. The only way to ensure the UHF radio is set to the desired B/U frequency, upon MDP failure, is to select UHF B/U or BOTH, again, to check the display.

The following functions are available via the UHF Backup Control Panel:

- Selection of MAIN (MN) or BOTH (MN + GD) modes.
- Selection between channels (preset) or frequency (manual).
- Setting the desired channel or frequency.

UHF Backup Control Panel Controls

Power Knob	Activates the UHF Backup Control Panel and UHF radio. Push for squelch.
Channel Select Button (CHAN)	Toggles between manual and preset frequency selections. When held for more than 3 seconds, activates program mode.
Frequency/Channel Select Knob	In manual mode, outer knob tunes transceiver in 1-MHz increments. Inner knob tunes transceiver in 25-KHz increments. In preset mode, either knob can be used to select channels.
PUSH TONE	When pressed, activates 1-KHz tone transmitter.

MODE Select	Toggles between MAIN (transmit and receive on same frequency) and BOTH (transmit on displayed frequency, receive on displayed frequency and Guard) modes.
-------------	---

UHF Backup Control Panel Displays

Channel Number Display	Top line of frequency display window. Contains channel number when in preset/Guard Mode. Blank in Manual Mode.
Frequency Display	Bottom line of frequency display window. Contains active frequency in all modes.
Transmit (TX) Annunciator	Illuminated whenever transmitter is active (mic button pressed).
Main (MN) Annunciator	Illuminated in either MAIN or BOTH Modes of operation.
Guard (GD) Annunciator	Illuminated while in BOTH Mode or whenever guard frequency is active.

NOTE

- There is no VHF backup control panel. When the MDP is off or failed, the VHF radio remains in its last setting and the volume is controlled via the ACP.
- If UHF B/U or BOTH is selected on the FCP AAP Backup Control Knob and the MDP and UFCP are operational, control of the VHF is unaffected.

PREPROGRAMMED APPROACHES (PPA)

PPA OVERVIEW

The MDP can store and recall up to 10 approaches for use by the aircrew. The approaches can either be navaid based or self-contained approaches. The system stores these approaches in data associated with DEST 500-509. The aircrew accesses the preprogrammed data using the UFCP APP Function Key.

PPA DATA

PPA DATA LOADING

Preprogrammed approach data can only be loaded via the DTS; changes cannot be made via the MFD or UFCP.

The aircrew builds the approaches as part of their preflight planning and transfers them to the aircraft using the DTS. Any one of the data locations can hold any of three types of approach: VOR, ILS, and SCA.

VOR/ILS Approach Data

Data used for VOR/ILS approaches include:

- a. Destination coordinates.
- b. Navaid frequency (DME channel not used).
- c. Final approach course.

The approach can be selected via window 2 of the UFCP NAV Sub-Menu Display. An asterisk is displayed next to APP to indicate the selection. At that time the EGI steerpoint is changed to the PPA DEST point (500-509) and the VOR/ILS frequency is changed to that selected for the approach. For VOR approaches, the VOR/ILS retunes to the VOR frequency immediately if VOR is the Primary or Secondary Navigation Source. For ILS approaches, the ILS frequency is tuned only when ILS becomes the PNS. The final approach course is loaded only when the aircrew selects the appropriate PNS.

SCA Approach Data

Data used for SCA approaches include:

- a. Destination coordinates and elevation.
- b. Final approach course.
- c. Final intercept point (FIP) distance.

- d. Final approach fix (FAF) distance.
- e. Glideslope.

When a SCA programmed approach is loaded, the EGI steerpoint changes to the one loaded with the approach and the remainder of the data is stored for use when the aircrew selects SCA as the PNS.

PPA SELECTION

Selection of the specific approach number to include activation of a PPA is accomplished on the UFCP NAV Sub-Menu Display. Refer to UP FRONT CONTROL PANEL (UFCP), this section.

Results of Entering Incomplete Data or Changing Data

The system checks the validity of the programmed approach when the aircrew loads the data location via the UFCP NAV Sub-Menu Display. The validity check includes verifying all required data is present and within proper limits, as if it was input manually. If any of the required information is missing from the loaded data the system does not accept the data as a programmed approach. After the system accepts the data as valid the aircrew must use the following guidelines to retain the data as valid.

Before the aircrew selects the PNS for the approach, they are free to manually enter a course for steering without influencing the programmed approach. If the aircrew changes the EGI steerpoint or destination point in the NAV Sub-Menu Display Window 2R, or the loaded navaid frequency (for VOR/ILS), the system removes the asterisk and the aircrew has to reload the approach when they want the programmed data. The impact of changing the steerpoint/loaded navaid frequency is as follows:

- a. VOR/ILS - Changing the steerpoint removes the asterisk from APP. Since APP has been deselected, further automatic features of the preprogrammed approach are disabled; the course does not automatically change upon selecting VOR/ILS as the PNS. If the frequency was changed, APP is unasterisked and preprogrammed features are disabled.

If the above condition resulted in the removal of the asterisk, the only way APP can be asterisked again is via UL-2 on UFCP NAV Sub-Menu Display.

T.O. 1T-38C-1

PPA

After the aircrew selects the PNS of the loaded preprogrammed approach, the following is affected:

- a. The selected course is set as loaded and the navaid is tuned (VOR/ILS).
- b. SCA - Neither the steerpoint nor selected course can be changed until SCA is exited. UR-1 of the UFCP Basic Menu Display, UR-2 on the UFCP NAV Sub-Menu Display, the course rocker switch on the MFD, and UL-2 and UR-2 on the UFCP SET Key Display are disabled until the mode is exited by selecting another source as the PNS.
- c. ILS/VOR - Changing the destination number via UR-2 on the UFCP NAV Sub-Menu Display or the frequency unasterisks APP and disables further automatic PPA features. Changing the course does not unasterisk APP but subsequently pressing UL-2 on the UFCP NAV Sub-Menu Display resets the course to the preprogrammed value.
- d. For all approach types, selecting another PNS does not unasterisk the APP. Reselecting matching navigation sources causes the system to respond as described above.

UFCP APPROACH (APP) FUNCTION KEY

The APP Function Key selects the UFCP Approach (APP) Key Display which allows the aircrew to review a preprogrammed approach, refer to UP FRONT CONTROL PANEL (UFCP), this section.

SELF CONTAINED APPROACH (SCA)

A self contained approach is an aircraft system-generated approach derived from a series of preprogrammed data including the following:

- a. Coordinates (latitude/longitude) and altitude.
- b. Course.
- c. Glideslope.
- d. FAF distance.
- e. FIP distance.

All SCA data must be input via the MPC/DTS and is not changeable in the aircraft.

The data must include latitude, longitude, and altitude. Normally the data is the desired point the glideslope would intersect the runway since the system-generated course and glideslope originate from this point. The data must be programmed into one of the destinations numbered 500-509 for each preprogrammed approach.

The programmed course generates the centerline for the final approach course leading from the FIP to the programmed destination coordinates. The CDI and FD provide steering cues to the final course regardless of orientation.

The FAF is a point along the final approach course where the FAF symbol is displayed on the HSD. The programmed FAF distance defines the distance in NM between the programmed coordinates and the FAF symbol on the HSD. This distance does not necessarily have to coincide with the intersection of the glideslope line and the desired altitude prior to glideslope intercept.

NOTE

If the FAF is placed outside this intersection, the system shows the aircrew as below glideslope at the FAF and above glideslope if the FAF is placed inside this intersection.

The FIP is the point along the final approach course in NM, where intercepting final is desired. This distance is where the turn radius circle tangent is placed along the final course.

SCA CONTROLS AND DISPLAYS

SCA is strictly a preprogrammed approach. The only control available to the pilot is loading the approach data via the UFCP NAV Sub-Menu Display, window 2, and activating the approach by selecting SCA as the PNS via MOSB MT-6 or UR-4 on the UFCP NAV Source Sub-Menu Display. Additionally, UL-2 of the UFCP Basic Menu Display allows the pilot to manually select FNL if the automatic switching feature does not occur or for any other reason. Refer to UFCP, this section.

SCA Submodes

SCA is broken down into two submodes, FIP and FNL. The displays (Figure 1-256) are slightly different but the differences are significant. The default submode upon SCA entry is FIP regardless of the position on the approach. The submodes automatically switch from FIP to FNL if the aircraft passes within 2 miles laterally of the FIP with a heading within 90° of the final approach course. If the above criteria are not met, automatic switching does not occur regardless of the aircraft position on the approach.

SCA MFD Displays, FIP and FNL Submodes

Once the approach is activated and SCA is selected as the PNS, the SCA title at MOSB MT-6 is boxed. In FIP submode, assuming within range based on the scale selected, the HSD display shows the following:

- a. The 2.5 NM turn radius circle.
- b. A line connecting the aircraft present position to the circle tangent; if the circle is not visible the line starts at the aircraft symbol and goes off scale.
- c. A line representing the final approach course from the FIP through the FAF symbol to an airport symbol, showing the location of the selected destination the approach is based on.

The HSD displays a CDI with the final approach course set and the raw data glideslope information is displayed on the EADI. TTG is based on the approach, but the calculations vary depending on what segment of the approach the aircraft is established on as discussed below. The FD gives bank steering to intercept the FIP circle in FIP and bank and pitch steering in FNL. The FD default is on.

SCA HUD Displays, FIP and FNL Submodes

The HUD displays raw data final course and glideslope information. Either FIP or FAF, depending on the current SCA submode, replaces the Avionics Master Mode. The EGI bearing arrow follows the logic listed below for the segment of the approach. The TD box is displayed at the airport location (gear up or down).

SCA UFCP Displays, FIP and FNL Submodes

The UFCP Basic Menu Display shows SCA in window 1L. The selected destination the approach is based on is displayed in window 1R, Window 2 displays either FIP or FNL, depending on the current submode, replacing the navaid frequency display, see Figure 1-256. SCA is asterisked in window 4R of the NAV Source Sub-Menu Display, and APP is asterisked on the NAV Sub-Menu Display, window 2L.

SCA HUD and MFD Displays, FIP Submode

In the FIP submode, the HUD and MFD displays are affected in the following manner.

Prior to reaching the tangent of the 2.5 NM turn radius circle, the EGI bearing pointer points to the circle tangent. Displayed range, TTG calculations,

and flight director commands (bank only) are to this tangent point. Upon touching the tangent, the system automatically transfers to an intermediate display as follows:

- a. The line connecting the aircraft symbol to the FIP circle is removed, MFD HSD only.
- b. The EGI bearing pointer points directly to the FIP (the point where the turn radius circle is tangent to the final approach course).
- c. The range and TTG displayed are calculated to the FIP based on flying the turn radius circle.
- d. The flight director gives commands (bank only) to maintain the circle commanding a maximum of 30° of bank.

NOTE

- At speeds greater than 240 knots, the commanded 30° bank is not sufficient to maintain the turn radius circle.
- As long as the turn circle is not touched prior to the FIP, the system continually updates a new line from the aircraft to the tangent (and associated range/TTG calculations) and updates FD commands accordingly. Not actually touching the circle (flying just outside the circle) can cause the range and TTG to stop decreasing or increase if the distance from the aircraft to the circle has increased. The system does not transfer to the intermediate display until the circle is actually touched.

SCA HUD and MFD Displays, FNL Submode

In the FNL submode, the HUD and MFD displays are affected in the following manner:

- a. The line connecting the aircraft symbol to the FIP circle is not shown, MFD HSD only.
- b. The EGI bearing pointers point to the programmed destination for the approach, normally the desired point of runway interception.
- c. Range and TTG calculations are made to the selected approach destination (steerpoint displayed on the UFCP Basic Menu Display, window 1R).

T.O. 1T-38C-1

PPA

d. FD gives pitch and bank commands to intercept and maintain course/glideslope using the same logic as the ILS commands but derived from the defined glideslope angle.

SCA NAVIGATION

To fly the approach, the data must be loaded via window 2R of the UFCP NAV Sub-Menu Display and activated by pressing UL-2; APP is asterisked indicating the data is inserted (and unchanged). At that time, SCA is displayed in the UFCP NAV Source Sub-Menu Display and at MFD MOSB MT-6. (If BC is displayed at MT-6, SCA does not replace BC.) Additionally, the steerpoint in window 1R of the UFCP Basic Menu Display is updated to reflect the destination loaded as the new steerpoint. If operating in EGI, VOR, or ILS/LOC/BC as the PNS when the data is loaded, normal navigation for that source may continue but the steerpoint is changed for the loaded data.

If the steerpoint is changed prior to selecting SCA, APP is unasterisked and the SCA approach is no longer available unless loaded again.

When SCA is selected as the PNS, the course is automatically set to the preprogrammed approach and HUD and MFD displays default to the FIP submode. Additionally, the MFD course rocker switch, UL-2 on the UFCP SET Key Display, and UR-1 on the UFCP Basic Menu Display, and UR-2 on the UFCP NAV Sub-Menu Display are disabled until the SCA is deselected.

Once the aircrew selects SCA as the PNS, the FD defaults on and the system guides the aircraft to

intercept the 2.5-mile turn radius circle. The system then directs a turn to align the aircraft with the final approach course at the FIP. When the aircraft reaches the conditions for automatic transition to FNL (when the aircraft passes within 2 NM of the FIP and the distance from the FIP starts to increase), the system automatically switches the displays and steering to the FNL mode and the full SCA approach is active.

PPA VOR/ILS/DME APPROACHES

PPA approaches can include VOR and ILS approaches. Controls are as described under PPA DATA LOADING, VOR/ILS Approach Data, this section.

VOR/ILS/DME CONTROLS AND DISPLAYS

Displays associated with VOR/ILS preprogrammed approaches are the same as those for approaches that are set-up manually. Controls differ only in the PPA data loading procedures described above. After loading the PPA data; course, frequency, and EGI steerpoint can be modified as normal. Refer to GROUND BASED NAVIGATION, this section.

VOR/ILS/DME NAVIGATION

Navigation associated with VOR/ILS preprogrammed approaches is the same as with approaches that are set-up manually. Refer to GROUND BASED NAVIGATION, this section.

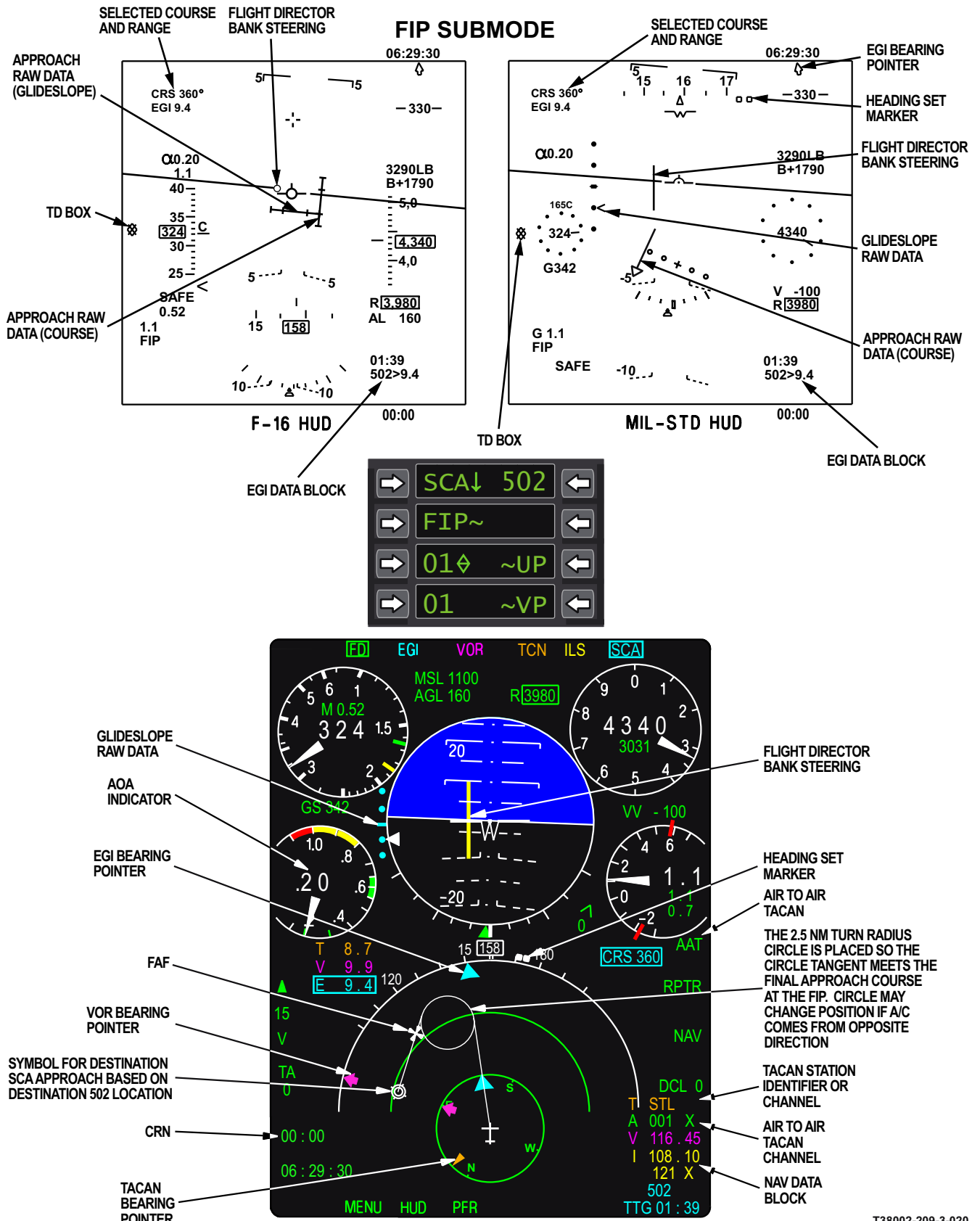
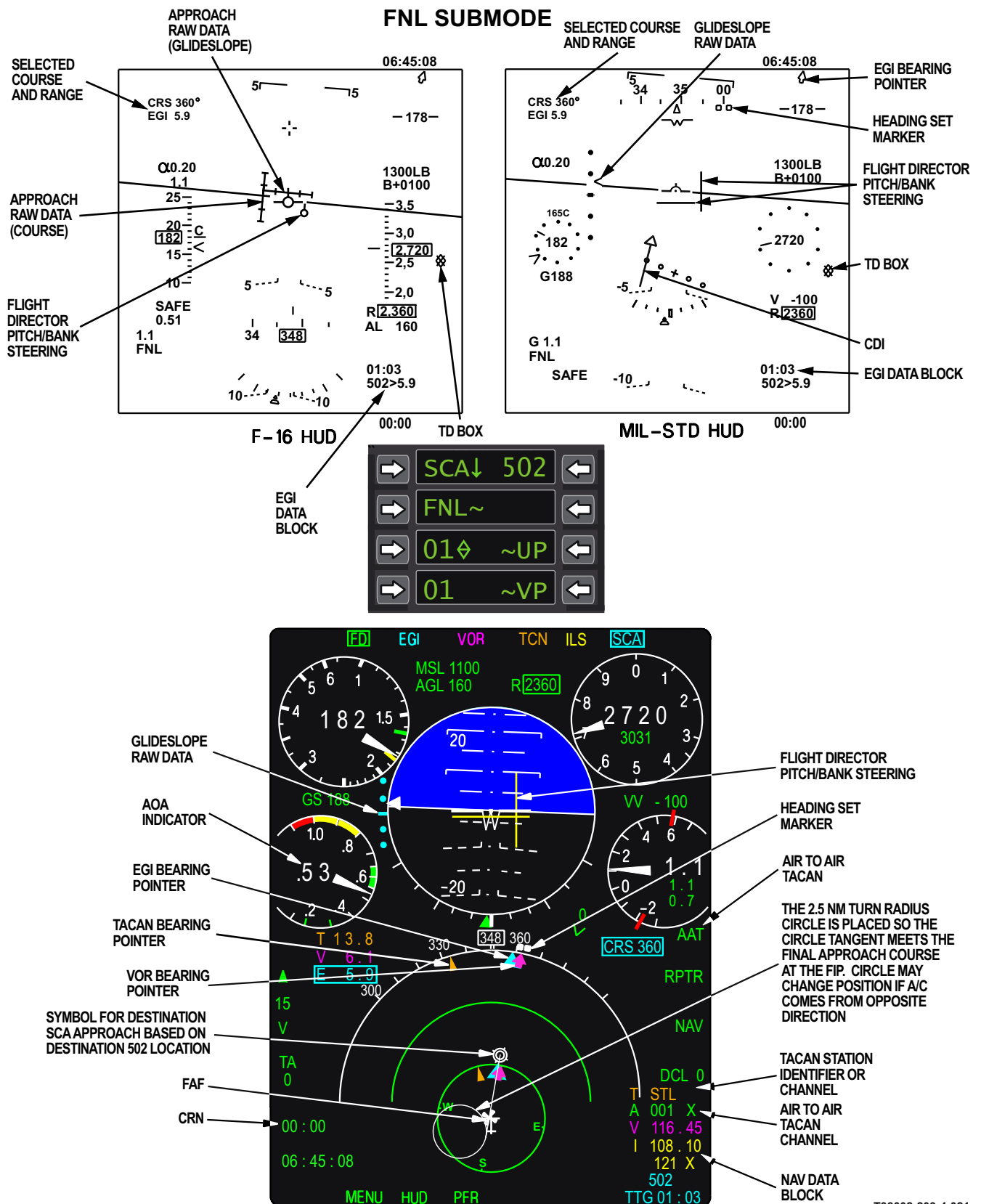

Figure 1-256. SCA Displays (Sheet 1 of 2)

T38002-209-3-020



T38002-209-4-021

Figure 1-256. SCA Displays (Sheet 2)

COMMUNICATION EQUIPMENT

COMMUNICATION SYSTEM OVERVIEW

The communication system provides the following features:

- a. Radio communication - transmission (controlled via HOTAS) and reception via the communication subsystems (UHF and VHF).
 - (1) Simultaneous reception on three channels: UHF main channel + guard (TR+G) and VHF main channel or guard.
 - (2) Transmission on either the UHF channel or VHF channel.
- b. Internal - cockpit communication between aircrew.
- c. TCAS aural alerts. Refer to IDENTIFICATION FRIEND OR FOE (IFF)/TRAFFIC COLLISION AVOIDANCE SYSTEM (TCAS), this section.
- d. Communication between the aircrew and ground crew via the intercom system.
- e. NAV audio control - selection of the radio navigation audio identifier
- f. Aural tones - Refer to WARNING/CAUTION/ADVISORY (WCA) SYSTEM, this section.

The UHF and VHF radios, and VHF NAV are normally controlled by the MDP via the UFCP. The UHF radio and VHF NAV have backup control panels that are enabled via the Backup Mode Control Knob on the AAP. The AAP automatically transfers control of the UHF radio and VHF NAV to the respective control panel if the MDP is off or has a total failure. There is no backup control for the VHF radio. The VHF radio will remain on the last tuned frequency upon MDP failure.

NOTE

- UHF and VHF communications can be affected when the aircraft is in or near thunderstorms and/or cirrus formations. The effects are static, garbled reception, popping, and background noise in the communications. The effects generally clear when the aircraft departs the area or environment.

- The UHF Backup Control Panel Power Knob and the NAV Backup Control Panel Mode Knob must be out of OFF to enable any UHF radio operation, in either normal or backup modes.

AUDIO CONTROL PANEL (ACP)

The ACP (Figure 1-257) is mounted in each cockpit instrument panel. All the functions of the system are unique for each cockpit.

Microphone (MIC) Switch

The MIC Switch selects between HOT and COLD microphone for inter-cockpit and ground crew communication. When both switches are in COLD, neither cockpit can hear the others intercom audio. When only the FCP MIC Switch is in the HOT position (HOT MIC); the RCP hears FCP intercom audio, but the FCP does not hear the RCP intercom audio. When the RCP MIC Switch is in the HOT position; both cockpits are in HOT MIC, regardless of the FCP switch position. Each cockpit will hear the other's intercom audio. Transmitting/receiving on UHF/VHF is enabled regardless of switch position.

Intercom Volume Knob (I/C)

The I/C Volume Knob controls the volume between cockpits. The FCP I/C Volume Knob also controls the incoming audio level from the ground crew and the intercom audio level recorded on the VTR.

VHF Volume Knob (VHF)

The VHF Volume Knob independently controls the radio receive volume of the VHF in each cockpit. VHF volume controls are still active when the MDP is OFF or failed.

UHF Volume Knob (UHF)

The UHF Volume Knob independently controls the radio receive volume of the UHF in each cockpit. UHF volume controls are still active when the MDP is OFF or failed, or when the UHF is in the backup mode.

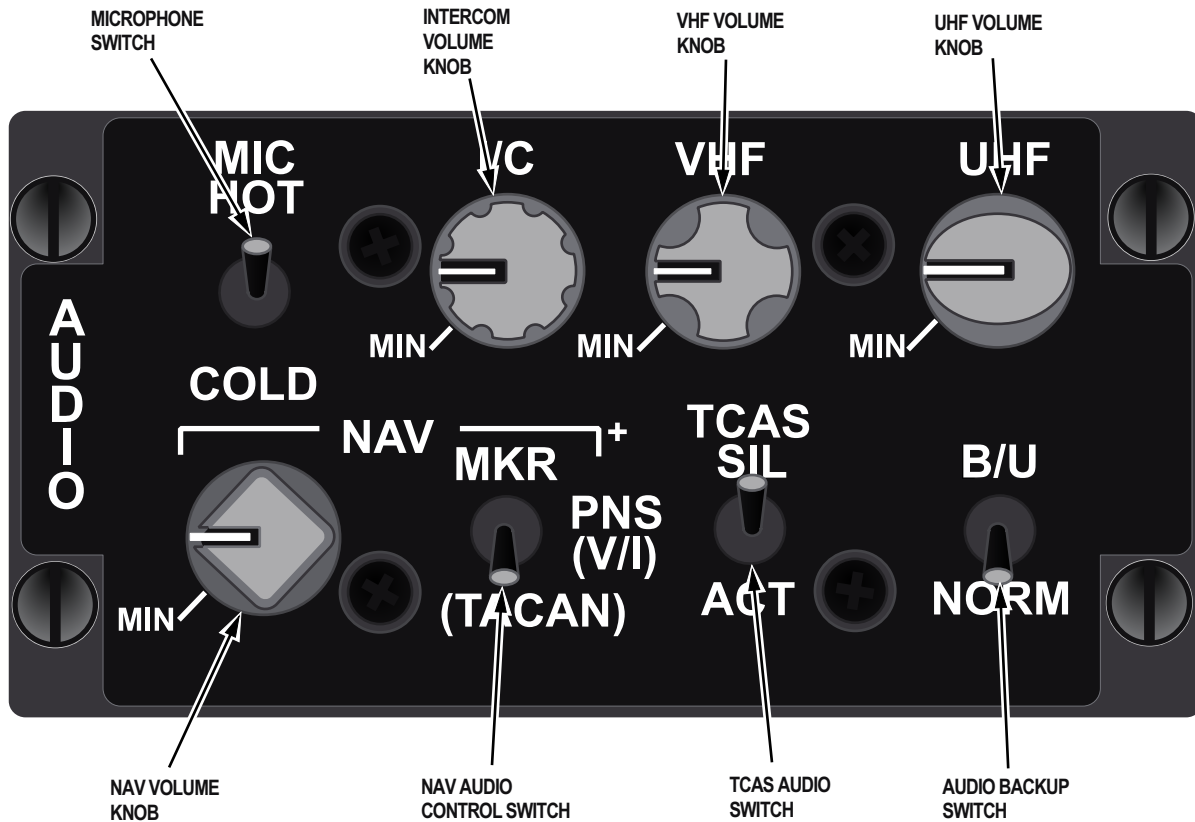

Figure 1-257. Audio Control Panel

T38002-577-1-020

NAV Volume Knob (NAV)

The NAV Volume Knob controls the volume received from the NAV radio sources, as selected by the position of the NAV Audio Control Switch, [MKR, PNS (V/I), or (TACAN)].

NAV Audio Control Switch

The three-position NAV Audio Control Switch controls the navigation audio available when the Backup Mode Control Knob on the AAP is in the normal

(NORM) mode being controlled by the MDP or in the backup (NAV B/U or BOTH) mode being controlled by the NAV and TACAN Backup Control Panels. The FCP controls the NAV audio selection for both cockpits except for Marker Beacon which can be selected independently by each aircrew.

The PNS (V/I) and (TACAN) switch positions in the RCP have no effect on the NAV audio selection.

MKR	Marker Beacon audio code can be selected independently in each cockpit.
PNS (V/I)	When the FCP NAV switch is in PNS (V/I) position, the MDP selects VOR/ILS or TACAN audio, based on the PNS. If the MDP is off, or EGI is the PNS, VOR/ILS audio is selected. The VOR/ILS audio is always mixed with the auto-paired DME audio.
(TACAN)	When the FCP NAV switch is in the (TACAN) position, TACAN audio is selected regardless of the state of the MDP.

TCAS Audio Switch

The TCAS audio switch controls the TCAS aural alerts; the messages have a fixed volume. Refer to IDENTIFICATION FRIEND OR FOE (IFF)/TRAFFIC COLLISION AVOIDANCE SYSTEM (TCAS), this section.

SIL	Silent- TCAS aural alerts are inhibited
ACT	Active- TCAS voice warning is heard when an intruder aircraft is considered to be potentially hazardous.

Audio Backup (B/U) Switch

The two-position Audio Backup Switch selects between normal or backup amplifiers for UHF/VHF and intercom audio.

B/U	If one or both of the cockpits switches is in B/U, the system changes to the B/U amplifiers. There is no audio backup for TCAS, NAV, ground crew, and aural warnings.
NORM	Normal audio amplifier is selected. Both cockpit switches must be in NORM to return to normal operation.

**MISCELLANEOUS
COMMUNICATION EQUIPMENT
CONTROLS**

Throttle Microphone (MIC) Switch

The Push-to-Talk (PTT) MIC Switch on the throttle enables independent transmission on the UHF or VHF. It has a neutral position and two active, spring-loaded momentary positions. Transmission is enabled as long as the switch is held either forward or aft. When the switch is released, it returns to the neutral

position and transmission stops.

NEUTRAL (Center)	No transmission, both radios are in receive mode.
FWD	Transmission on the UHF.
AFT	Transmission on the VHF

Pressing the MIC Switch enables transmission from the respective cockpit. Simultaneously pressing the MIC Switch in both cockpits, on different radios, transmits from both cockpits simultaneously. The RCP has transmission priority when both cockpit MIC Switches are pressed simultaneously on the same radio.

ATTENUATION (ATTEN) SWITCHES

A two-position ATTEN Switch is installed in both cockpits on the left console ATTENUATE/ANTI-G Panel. The active (outboard) position is spring-loaded; the switch returns to the normal position when released. Activating either ATTEN Switch reduces the volume of the UHF and VHF in both cockpits by 66%.

COMMUNICATION (COMM) ANTENNA SWITCH

The aircraft is equipped with upper and lower UHF antennas. The COMM ANTENNA Switch is located on the left sub-panel of the front cockpit. Selecting UPPER or LOWER permits reception and transmission via the selected antenna.

Selecting AUTO uses the lower antenna for communication until a glideslope signal is received. When a glideslope signal is received, UHF communications are switched to the upper antenna and the glideslope is received through the glideslope antenna.

If UHF interference is encountered on any frequency, the UPPER position should be selected. (There may be a minimal impact to UHF communications with ground based or lower altitude targets. The UPPER position should be optimal for all UHF operations.) If interference continues, select the LOWER position. If interference still continues, deselect or turn off UHF GUARD operation through the UFCP. If interference continues, reselect or turn UHF GUARD back on.

T.O. 1T-38C-1 COMM

NOTE

- In ILS mode with a failed upper UHF antenna and the COMM ANTENNA Switch in AUTO, UHF will not be available until the COMM ANTENNA Switch is set to LOWER.
- Transmission on the lower UHF antenna may interfere with the ILS and cause the pitch steering bar to blank.

UHF/VHF CONTROLS AND DISPLAYS, UFCP

In the normal mode of operation, the UFCP is the main control panel for voice communication using either the UHF or VHF radio.

NOTE

To operate the UHF or VHF radios via the UFCP, the UHF Backup Control Panel Power Knob must be out of the OFF position and the AAP Backup Mode Control Knob must be in the NORM or NAV position.

The UHF and VHF radios are controlled via two UFCP displays:

a. The Basic Menu Display selects the desired preset channel or allows the aircrew to enter a manual frequency.

b. The Communication (COM) Key Display manages preset frequencies, changes the radio modes, and selects squelch and tone functions. The V Hot Key toggles VHF squelch on and off and the U Hot Key toggles UHF squelch on and off.

Refer to UFCP CONTROLS AND DISPLAYS, this section.

UHF/VHF DISPLAYS, MFD

The COMM data block on the MFD PFR and HSD displays shows the current tuned UHF frequency, current tuned VHF frequency, and current transponder Mode 3 ATC Code. Refer to MFD NAV AND COMM DATA, this section.

COMMUNICATION BACKUP MODE OPERATIONS

NOTE

There is no VHF backup control panel. When the MDP is OFF or failed, the VHF radio remains in its last setting.

UHF Backup Mode

When the MDP is OFF or fails, the UHF automatically enters backup mode. Manual selection of the backup control of the UHF radio is done by selecting UHF B/U or BOTH on the Backup Mode Control Knob on the AAP. UHF Backup Mode is controlled via the UHF Backup Control Panel. Refer to BACKUP CONTROL PANELS, this section.

IDENTIFICATION FRIEND OR FOE (IFF)/ TRAFFIC COLLISION AVOIDANCE SYSTEM (TCAS)

IFF SYSTEM OVERVIEW

The IFF system provides for aircraft identification. The IFF function is contained within the Mode S Transponder and allows the aircraft to identify itself automatically and report altitude when interrogated by surface or airborne equipment. The system allows identification in mode A, (position only) or mode C (position and altitude). When operating in Mode S, the transponder behaves as in Mode C, but with added TCAS functionality. Modes A and C are also known as modes 3A and 3C respectively. In response to interrogations the Transponder provides:

- a. Aircrew selected IFF squawk in all modes.
- b. Special Identification (SPI) pulse in all modes when Ident (IDT) is selected.
- c. Uncorrected barometric MSL Altitude (from ADC) in Modes C, S.
- d. Non-selectable, FAA assigned Aircraft Unique ID in Mode S.
- e. Resolution Advisory (RA) data link in Mode S when the TCAS mode is resolution advisories.

NOTE

- When power is removed from the MDP, the transponder continues to respond to interrogations. When the MDP powers up again, it commands the TCAS (including the transponder) to standby mode and last manually entered ATC code.
- When the system senses WOW, it inhibits all replies to Air Traffic Control Radar Beacon System (ATCRBS) Mode A and C interrogations. The TCAS replies to Mode S interrogations.

TCAS SYSTEM OVERVIEW

TCAS is a system used for detecting and tracking aircraft in the vicinity of your own aircraft. TCAS interrogates the transponders of other aircraft and determines the range and bearing of the intruders. Transponders operating in Mode C or S also report the uncorrected barometric altitude of the intruder

aircraft. Should TCAS determine that a possible collision hazard exists, it issues visual and aural alerts to the crew for appropriate vertical avoidance maneuvers.

NOTE

ATC procedures and the see and avoid concept continues to be the primary means of ensuring aircraft separation. If communications are lost with ATC, TCAS is a backup system for collision avoidance.

The TCAS consists of two units, the TCAS processor and Mode S Transponder. The TCAS processor interrogates and tracks intruder aircraft. The Mode S Transponder data link coordinates climb/dive commands during RA with other TCAS II equipped aircraft. The TCAS is also dependent on the UFCP for input and the MDP for controlling the HUD and MFD visual displays.

TCAS Processor inputs:

- a. Attitude and Heading from the EGI via an ARINC 429 bus.
- b. AGL Radar Altimeter data from the MDP via an ARINC 429 bus. The data originates in the EGI, and is processed and formatted for the TCAS system by the MDP.
- c. Uncorrected barometric MSL Altitude from the ADC via an ARINC 429 bus with the Mode S Transponder.
- d. RF data from the directional upper antenna and the non-directional lower antenna. The RF signals originate from the Mode S transponders in other aircraft.

The TCAS Processor monitors airspace around ownship by interrogating intruder aircraft and receiving other aircraft transponder transmission replies to the interrogation. If the transponder signals are received by the upper directional antenna (located on the nose of the aircraft), the TCAS Processor determines the range and bearing of the intruder. If the transponder signal is received by the lower antenna only (below the cockpit) the TCAS Processor only determines the range. The TCAS processor computes the differential altitude (for IFF mode C capable aircraft), bearing (if

T.O. 1T-38C-1

IFF/TCAS

the intruder is received by the upper antenna), and closure rate of the intruder (based on changes in range), compares that information with projected ownship position, and determines the potential for collision.

Up to 30 aircraft within the surveillance range of TCAS can be displayed as intruders. The TCAS Processor issues voice message aural alerts and provides data to the MDP for generation of visual alerts. The visual alerts consist of intruder aircraft symbols and vertical maneuvering commands displayed on the EADI and HUD. The intruders are divided into four categories of threats, each of which is displayed by a dedicated symbol shape and color. The nature of the aural and visual alerts depends on:

- a. Aircrew selected operating mode, Traffic Advisory (TA) or RA.
- b. Closure Rate of the intruder aircraft.
- c. Flight Conditions (altitude and attitude).
- d. Equipment on board the intruder aircraft.

IFF/TCAS CONTROLS

AAP TCAS CONTROLS

IFF/TCAS is powered on/off via the TCAS power switch on the AAP. When both the TCAS and MDP are on, the TCAS modes and functions are controlled via the UFCP.

NOTE

TCAS displays OFF for up to 45 seconds after powerup. TCAS powerup default is SBY mode and last displayed ATC code.

ACP TCAS CONTROLS

The TCAS audio control switch (SIL/ACT) on the ACP controls the TCAS audio. TCAS aural alerts are inhibited when the TCAS audio switch on the ACP is in SIL.

UFCP IFF/TCAS CONTROLS AND DISPLAYS

UFCP IFF FUNCTION KEY

The UFCP IFF/TCAS (IFF) Key Display is selected by pressing the UFCP IFF function key on the UFCP and provides display and control of the following TCAS functions and parameters:

- a. TCAS title (TCS)
- b. IFF squawk
- c. IFF/TCAS mode : SBY, A, C, TA, or RA
- d. VFR squawk selection
- e. Relative altitude display limits: ABV, BLW, NOR, or BLK
- f. Emergency (EMR) squawk selection
- g. Flight Level (FL)
- h. Ident (IDT)

Refer to UFCP IDENTIFICATION FRIEND OR FOE (IFF) FUNCTION KEY, this section.

IFF/TCAS MODES

The TCAS has 5 operating modes, Resolution Advisory (RA), Traffic Advisory (TA), Mode C, Mode A, and Standby (SBY). Modes RA and TA are TCAS modes with the Transponder operating in Mode S. Modes C and A are IFF modes with no traffic avoidance function. SBY mode is effectively the same as off.

TCAS Modes can be selected via the following:

- a. UFCP IFF/TCAS (IFF) Key Display
- b. Weapon Mode Switch (TA and RA in NAV master mode only)

RESOLUTION ADVISORY (RA)

When a proximity to collision situation is detected, the system alerts the aircrew and advises climb or dive corrective action to avoid the intruder aircraft. The system issues both aural and visual warnings. The visual warnings consist of intruder aircraft symbols on the EHSI and HSD, and vertical maneuvering commands on the EADI and HUD, see Figure 1-259, Figure 1-260 (sheet 1 and 2). Two TCAS II equipped aircraft will coordinate their resolution advisories using the Mode S Transponder data link. The coordination ensures both aircraft maneuver in the opposite direction.

TRAFFIC ADVISORY (TA)

When operating in TA mode, the aircrew is advised of a potential threat with a visual intruder symbol on the EHSI and HSD, and an aural alert, but no recommended vertical maneuvers are given. When intruding aircraft reach a point where the system predicts the closest point of approach (based on current flight path) to be between 20 and 48 seconds, a traffic alert is issued.

MODE C

When interrogated, the transponder will transmit the aircrew selected squawk and uncorrected barometric altitude from the ADC.

MODE A

When interrogated, the transponder will transmit the aircrew selected squawk.

STANDBY

When the TCAS is first turned on, it executes a self test and places itself into standby mode until commanded by the MDP to another mode. At MDP start-up, the MDP commands standby until the aircrew selects a different TCAS mode via the UFCP IFF/TCAS (IFF) Key Display. In standby mode, the TCAS processor and Mode S Transponder have power, but are inactive.

TCAS MODES AND DISPLAYS

TCAS modes and resulting displays are shown in the following table:

MODE	DATA TRANSMITTED TO OTHER AIRCRAFT	DISPLAY
SBY	NOTHING	NONE
A	POSITION	NONE
C (C+A)	POSITION AND ALTITUDE	NONE
TA (C+A+TA)	POSITION AND ALTITUDE	TA
RA (C+A+TA+RA)	POSITION AND ALTITUDE	TA+RA

RELATIVE ALTITUDE DISPLAY LIMITS

The relative altitude display limits are MFD display limits only; the TCAS system search area exceeds these limits and can give aural warnings for targets

outside the selected vertical display limits. ABV is the TCAS powerup default. The limits are defined as follows:

- a. Above (ABV): 2700 ft below to 8700 ft above ownship
- b. Below (BLW): 8700 ft below to 2700 ft above ownship
- c. Normal (NOR): 2700 ft below to 2700 ft above ownship
- d. Block (BLK): 9000 ft below to 9000 ft above ownship

FLIGHT LEVEL (FL)

The intruder and ownship altitude are displayed on the MFD in FL format when the flight level function is activated. The MFD display returns to the relative altitude display format when FL display mode is deactivated.

IDENT (IDT)

When selected, a Special Identification (SPI) pulse is included with transponder replies to interrogations for 15 seconds.

MFD TCAS CONTROLS AND DISPLAYS

The MFD displays air traffic and controls the display scale and intruder decluttering. The traffic situation is displayed on the EHSDI, Figure 1-260 (sheet 1 of 2) and HSD displays, Figure 1-260 (sheet 2) using dedicated colored and shaped symbols, together with numeric data, to help the pilot understand the surrounding air traffic situation. The MFD display presents an ownship symbol and traffic that is detected and monitored by the TCAS. Each intruder is presented in a dedicated colored and shaped symbol according to its threat level.

TCAS MODE DISPLAY

The TCAS mode, OFF, SBY, A, C, TA or RA, is displayed next to ML-6. Upon changing the TCAS mode, the ML-6 displayed mode flashes for 15 seconds or until the TCAS enters the commanded mode, whichever comes first. Once the displayed mode stops flashing the current operating mode is display in green if it matches the commanded mode, or in yellow if it failed to enter the commanded mode.

T.O. 1T-38C-1 IFF/TCAS

TCAS INTRUDER DISPLAY

The symbols for each intruder are as follows and are displayed in Figure 1-260 (sheet 1 of 2):

- a. Non-threat aircraft are an open white diamond.
- b. Proximity aircraft are a solid white diamond.
- c. Threat aircraft at TA level are a solid yellow circle.
- d. Threat aircraft at RA level are a solid red square.

NOTE

In TA mode the TCAS displays the RA threat as a TA symbol.

The following data can be displayed adjacent to an intruder symbol:

- a. Relative altitude is displayed (white) in two digits for thousands and hundreds of feet (i.e., 700 feet is displayed as 07). If the intruder is above ownship, the relative altitude is displayed above the intruder symbol with a preceding (+). If the intruder is below ownship, the relative altitude is displayed below the intruder symbol with a preceding (-). Relative altitude is displayed only if the intruder is reporting altitude.
- b. When the intruder vertical velocity is 500 fpm or greater, a white arrow is displayed to the right of the symbol. For ascending intruders the arrow points up; for descending intruders the arrow points down.
- c. When the flight level function is activated, the white relative altitude and arrow is replaced with the intruder's own reported altitude data in FL format with three digits for tens of thousands, thousands, and hundreds of feet (i.e., 11,300 feet is displayed as 113, and 5200 feet is displayed as 052).

TCAS INTRUDER DISPLAY PRIORITIES

Intruder symbols and their attached data have priority over all other PFR and HSD symbols. When intruder symbols overlap, they are displayed in the following priority:

- a. Threat aircraft at RA level.
- b. Threat aircraft at TA level.
- c. Proximity intruders.
- d. Non-threat intruders.

INTRUDERS WITH NO VALID BEARING DATA

Intruders with no valid bearing data are listed on either side of the EHSD/HSD with the relative altitude, intruder symbol, and arrow, followed by the range in NM displayed in a row. The data is boxed in the same color as the intruder symbol color. Up to 10 rows can be displayed at any time, five each to the left and right side of the EHSD/HSD with the first at top left, the second at top right, the third at second top left, etc. The order is according to the following priority:

- a. RA
- b. TA
- c. Proximity

Non-threat category aircraft are not displayed. If more than 10 intruders need to be displayed, the top priorities are displayed. The intruders of the lowest priority detected last are not displayed.

NOTE

The TCAS antenna patterns have narrow cones directly above the aircraft and a wider cone directly below the aircraft where the system is unable to accurately resolve a target bearing. The TCAS sensor is able to track targets in these areas and determine their threat status based on valid range and altitude data. If a no-bearing target is a non-threat, it is not displayed on the EHSD or HSD. If the target becomes a threat before the system has resolved bearing, it is displayed to the left of the EHSD with a relative altitude and the appropriate voice commands are provided.

INTRUDERS BEYOND SELECTED RANGE

TA, RA, and proximity aircraft that are beyond the display scale are represented by half the intruder symbol with the attached data (relative altitude and arrow), Figure 1-258.

On the PFR display, an intruder beyond the selected range scale is positioned on an imaginary circle beyond the EHSD scale. The radial placement on the circle represents the bearing of the intruder.

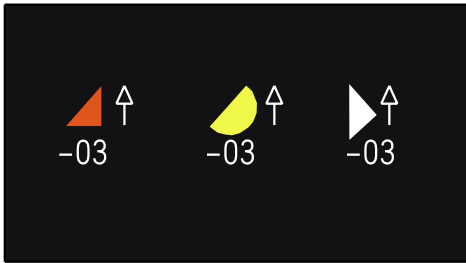

T38002-584-1-020

Figure 1-258. Intruders Beyond Selected Range

On the HSD, an intruder beyond the selected range scale is positioned on an imaginary circle beyond the HSD outer scale (between 8 and 4 o'clock), or positioned at the bottom of the display. The radial placement on the circle or bottom of the display represents the bearing of the intruder.

The symbol begins to move and becomes a full sized intruder symbol when the intruder range is equal to or less than the maximum range on the display scale.

RANGE SCALES

On the MFD PFR display, the EHSI circle is used as a range scale, 2.5, 5, 10, or 20 NM. The range is measured from the aircraft symbol to the EHSI circle. The default value upon MDP powerup is 10 NM. The PFR TCAS range scale is only presented in (TA) or (RA) mode.

On the MFD HSD display, the TCAS range scale is always presented and matches the HSD range scale, 15, 30, 60, 120 NM. The range is measured from the aircraft symbol to the outer scale. The default value upon MDP powerup is 30 NM.

The selected range is displayed on the HSD/EHSI between the arrows at ML-4 and ML-5. Range scale control is accomplished by pressing ML-4 to increase range and ML-5 to decrease range. Range can also be changed using the Master Mode Switch (MMS). Refer to HANDS ON THROTTLE AND STICK (HOTAS), this section.

The arrows change to solid triangles to display the TCAS relative altitude display limits (BLW, ABV, NOR, BLK) selected on the UFCP IFF/TCAS (IFF) Key Display. If BLW is selected, the down arrow is replaced with a solid triangle. If ABV is selected, the up arrow is replaced with a solid triangle. If NOR is

selected, neither arrow is replaced with a solid triangle. If BLK is selected, both arrows are replaced with solid triangles. Refer to HORIZONTAL SITUATION DISPLAY, this section.

OWNSHIP AIRCRAFT SYMBOL

The ownship Aircraft Symbol is displayed on the PFR and HSD. Ownship altitude in FL format is displayed on the right side of the ownship when the FL function (UR-4) is selected on the UFCP IFF/TCAS (IFF) Key Display.

TCAS DISPLAY DECLUTTER, ML-6

This option is only displayed when the TCAS is in TA or RA mode. Three levels of TCAS display declutter are controlled via ML-6 on the MFD PFR and HSD Display Pages. Changing declutter levels does not change the current TCAS mode. MDP powerup default is declutter 0. The selected declutter level is displayed below ML-6 as follows:

- a. 0 - All aircraft within the TCAS surveillance range are displayed.
- b. 1 - Non-threat intruders are not displayed.
- c. 2 - Only threat aircraft at RA and TA level are displayed.



TCAS saturation and/or decluttering can cause intruders to not be displayed. See and avoid must remain the primary method of traffic collision avoidance.

TCAS RESOLUTION ADVISORY

The following occur when threat aircraft become RA level intruders:

- a. The intruder symbols on the MFD PFR and HSD Display Pages become solid red squares.
- b. Aural alert messages are generated.
- c. Vertical maneuvering commands are displayed on the EADI.

RA VERTICAL MANEUVERING COMMAND DISPLAY

When an aircraft becomes an RA level intruder, vertical maneuvering commands appear on the EADI. They are removed when the aircraft is no longer an RA level intruder. The advisory commands are only in elevation.

T.O. 1T-38C-1

IFF/TCAS

The RA vertical maneuvering command symbols (danger zones) on the EADI define the zones that the pilot should avoid. The danger zones symbols are trapezoid shaped areas that can appear above, below, (Figure 1-261), or both above and below the horizon line, Figure 1-260 (sheet 1 of 2), in accordance with the commanded vertical speed. The symbols are stabilized to the horizon. If the CDM is not selected, the pilot should fly the aircraft in such a way that the Waterline on the EADI stays out of the danger zones. If the CDM is selected, the pilot should fly the aircraft in such a way that the CDM on the EADI stays out of the danger zones.

On the EADI, the danger zone symbology is red. If the actual position of the trapezoid is outside the display area, it is extended and stops on the ghost horizon.

HUD TCAS DISPLAYS

TCAS RA vertical maneuvering commands are also displayed on the MIL-STD HUD in all modes, and on the F-16 HUD in NAV mode only. The display is stabilized to the horizon. The pilot should fly the aircraft in such a way that the FPM (F-16 HUD) or CDM(MIL-STD HUD) on the HUD stays out of the danger zone(s). On the HUD, the danger zone can appear above, below, or both above and below the horizon line, Figure 1-259 . If the actual position of the trapezoid is outside the HUD, it is extended 1° off the IFOV.

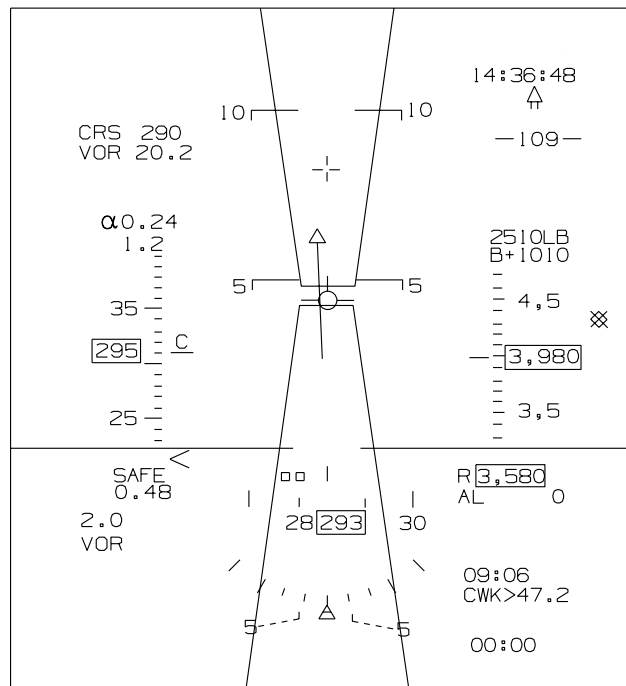

1. PILOT ADVISED TO KEEP FPM BETWEEN DANGER ZONES

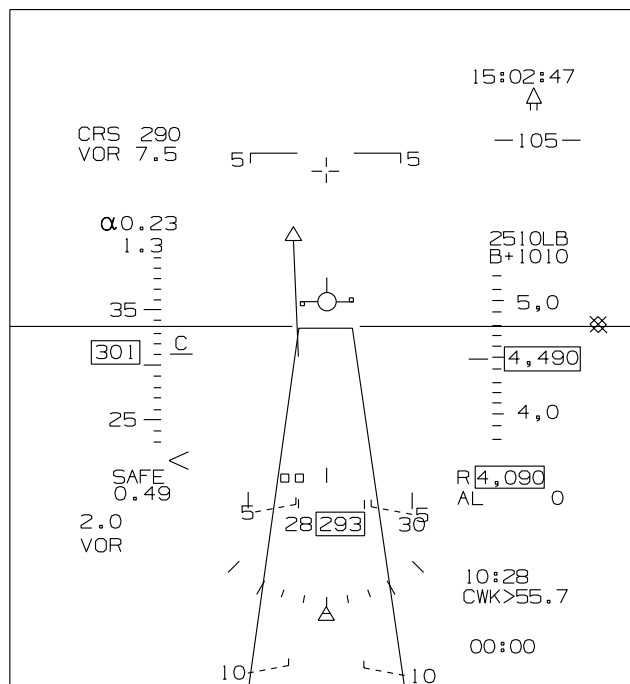

2. PILOT ADVISED TO KEEP FPM ABOVE DANGER ZONE

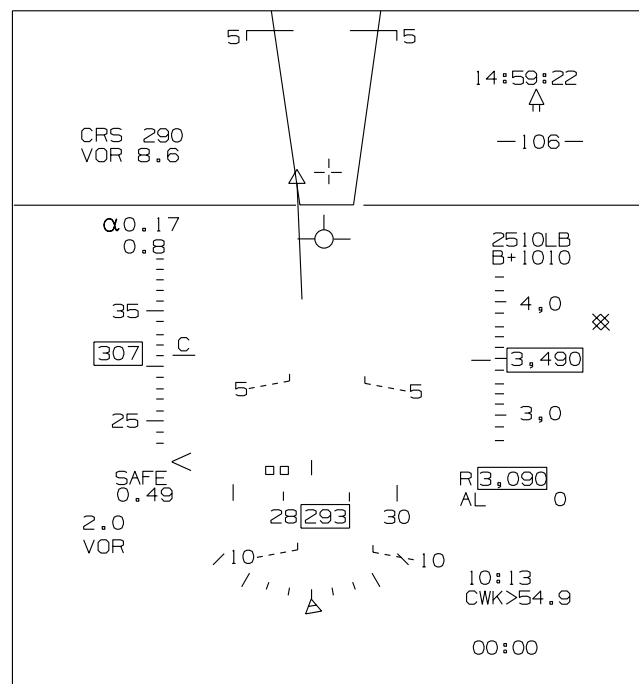

3. PILOT ADVISED TO KEEP FPM BELOW DANGER ZONE

Figure 1-259. HUD TCAS Display

T38002-585-1-020

T.O. 1T-38C-1
IFF/TCAS

TCAS AURAL ALERTS

TCAS aural alerts are generated by the TCAS system and do not enter the internal aural alert priority scheme of the MDP. They do not override or block MDP generated aural alerts. They are heard at the same time as MDP aural alerts if the timing is such that both aural alerts are generated at the same time.

TCAS TA TRAFFIC AURAL ALERT

The aural message, TRAFFIC, TRAFFIC, is generated by the TCAS when an intruder aircraft is considered to be potentially hazardous. This is the only TCAS aural alert received in TA mode.

TCAS RA TRAFFIC AURAL ALERTS

The following aural alerts can be heard during Resolution Advisories:

AURAL ALERT	DESCRIPTION
CLIMB, CLIMB, CLIMB	Double trapezoid vertical maneuvering commands indicate a climb between +1500 FPM to +2000 FPM.
INCREASE CLIMB, INCREASE CLIMB	Follows a CLIMB advisory. Double trapezoid vertical maneuvering commands indicate a climb between +2500 FPM to +3500 FPM.
REDUCE CLIMB, REDUCE CLIMB	FPM is in the upper trapezoid danger zone.
CLIMB, CROSSING CLIMB, CLIMB, CROSSING CLIMB	Same as CLIMB and further indicates that ownship flight path will cross that of intruder.
CLIMB-CLIMB NOW, CLIMB-CLIMB NOW	Follows a DESCEND advisory when it has been determined that a reversal of vertical speed (direction) is needed to provide adequate separation.
DESCEND, DESCEND, DESCEND	Double trapezoid vertical maneuvering commands indicate a descent between -1500 FPM to -2000 FPM.
INCREASE DESCENT, INCREASE DESCENT	Follows a DESCEND advisory. Double trapezoid vertical maneuvering commands indicate a descent between -2500 FPM to -3500 FPM.
REDUCE DESCENT, REDUCE DESCENT	FPM is in the lower trapezoid danger zone.
DESCEND, CROSSING DESCEND, DESCEND, CROSSING DESCEND	Same as DESCEND and further indicates that ownship flight path will cross that of intruder.
DESCEND-DESCEND NOW, DESCEND - DESCEND NOW	Follows a CLIMB advisory when it has been determined that a reversal of vertical speed (direction) is needed to provide adequate separation.
MONITOR VERTICAL SPEED, MONITOR VERTICAL SPEED	Current vertical maneuvering is in compliance with the vertical maneuvering commands.
CLEAR OF CONFLICT	The conditions resulting in a conflict with other aircraft no longer exist and no further restriction or advisory is required. The vertical maneuvering commands on the HUD and MFD are removed.

TCAS LIMITATIONS

If MODE C is selected by the aircrew the system automatically switches to MODE A if the Air Data Computer fails to transmit the required altitude data or if the altitude data is flagged as invalid.

The TCAS aural alerts are active only when the aircraft is airborne and in NAV master mode. When the aircraft is on the ground or A/A or A/G master mode is selected, the aural alerts are inhibited.

WARNING

Although the system is designed to inhibit resolution advisories at low altitudes, if there is an undetected failure in the radar altimeter, the TCAS resolution advisories (aural or visual) may be incorrect. If intermittent RALT reception is noticed while flying below 5000 feet AGL when the aircraft is not pitched or banked, RALT may be deselected on the UFCP or the TCAS mode may be switched to TA to inhibit the descend commands at low altitude.

The following limitations are implemented for safety reasons:

- a. The INCREASE DESCENT RA visual and aural alert is inhibited below 1450 feet AGL.
- b. If RA mode is selected, the TCAS operates in TA mode only with all aural alerts inhibited under any of the following conditions:
 - (1) Ownship is below 900 feet AGL.
 - (2) Ownship is below 1100 feet AGL and climbing.
 - (3) The RALT is disabled via the UFCP EGI Key Display or by selecting the POD configuration via ML-6 on the MFD WPN Display Page.
 - (4) RALT data is not valid and the aircraft is pitched or banked more than 30°

(TCAS assumes aircraft is at low AGL and loss of RALT is due to bank).

TCAS intruders may not be displayed for the following reasons:

- a. Intruder can have a weak transponder (ground stations detect aircraft further away than TCAS).
- b. TCAS has a maximum surveillance range of 40 NM nautical miles.
- c. TCAS enters interference limiting mode and therefore no longer interrogates intruders beyond 15 NM when multiple TCASs are interrogating at the same time.
- d. Mode S equipped intruders with a relative altitude difference of 3000 feet or more from ownship and calculated to not become co-altitude within 60 seconds, are not tracked while in interference limiting mode.
- e. Intruder's transponder is shadowed (line of sight between intruder transponder antenna and the TCAS antennas is blocked).
- f. Ownship is above 1750 feet AGL and intruder is close enough to the ground to be considered on-ground (on ground determination height is 380 ± 20 feet AGL).
- g. TCAS can track up to 60 intruders, but only the closest 30 are displayed.
- h. Intruder is determined to be more than 48 seconds from closest point of approach to ownship (calculated by assuming that both aircraft are traveling at their maximum reported airspeeds directly at one another).
- i. Intruder may lie in ownship cone of confusion (70° to 90° above aircraft) or is tracked by the bottom non-directional antenna (-10° to -90° below aircraft). Both of these prevent bearing determination.
- j. As an intruder crosses over from the forward quadrant to a side quadrant, or a side quadrant to the aft quadrant (at approximately ± 45° and ± 135°), the surveillance ranges are reduced and the intruder may not be tracked.

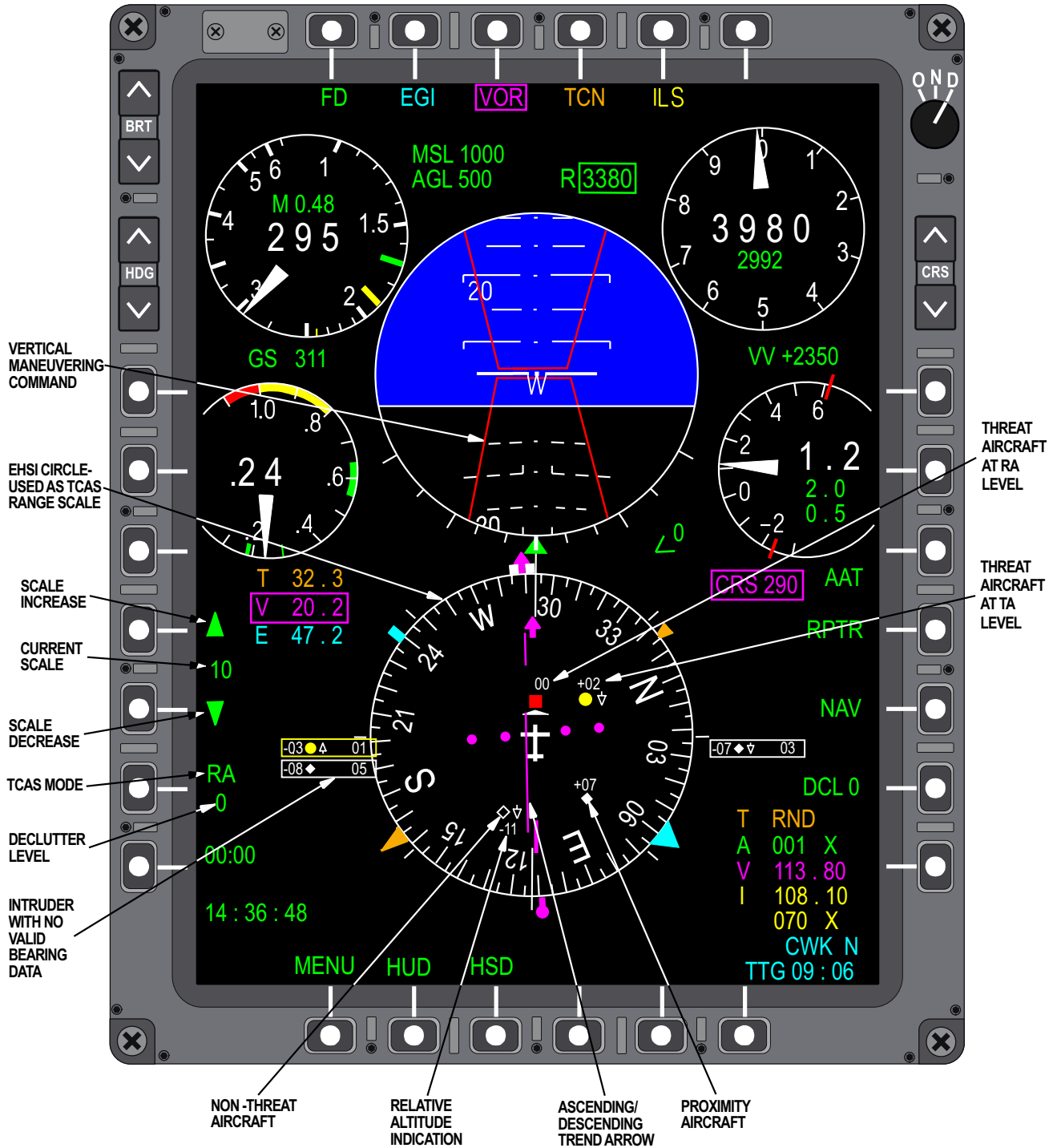

Figure 1-260. MFD TCAS Display and Symbols (Sheet 1 of 2)

T38002-574-1-020

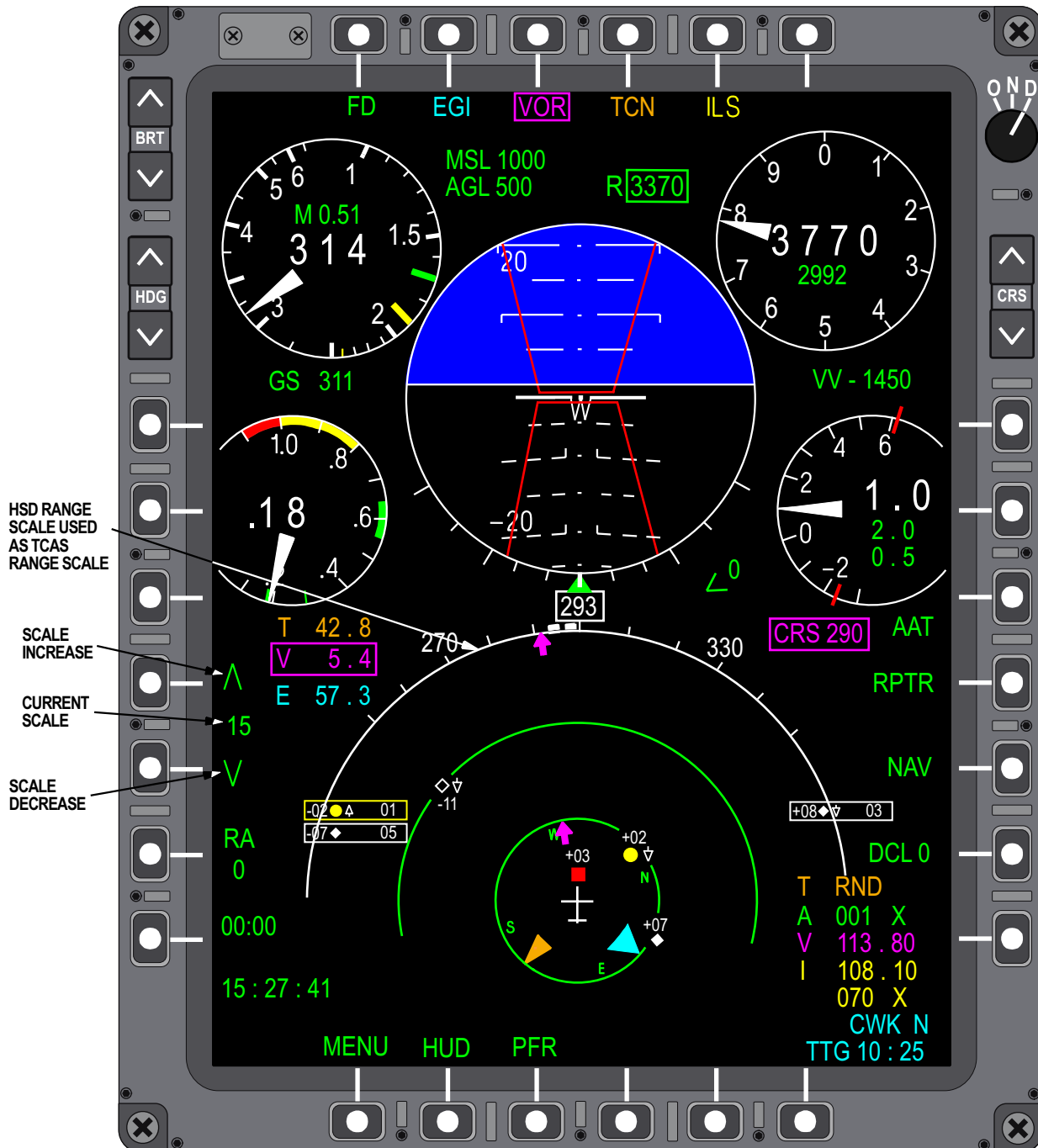
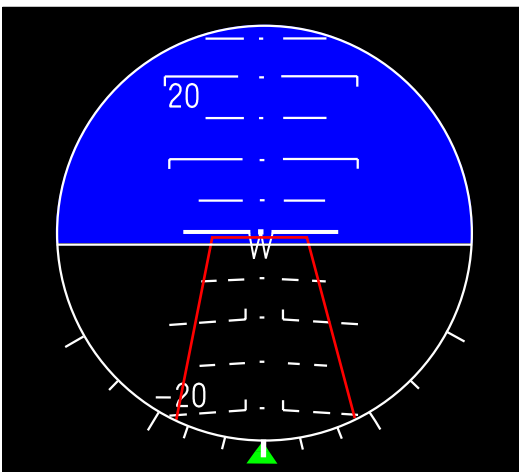
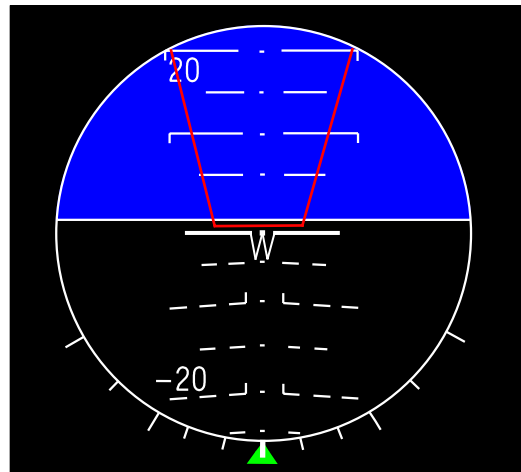

Figure 1-260. MFD TCAS Display and Symbols (Sheet 2)



1. PILOT ADVISED TO KEEP
THE A/C SYMBOL ABOVE
THE DANGER ZONE



2. PILOT ADVISED TO KEEP
THE A/C SYMBOL BELOW
THE DANGER ZONE

T38002-575-1-020

Figure 1-261. EADI TCAS Display

DATA TRANSFER SYSTEM (DTS)

DTS OVERVIEW

The DTS consists of a Data Transfer Cartridge (DTC or cartridge) and a Data Transfer Drive (DTD). The DTC is inserted into the DTD with the pin holes facing forward and the open tab slot facing up, Figure 1-262. The DTD is located in the FCP on the pedestal. The DTD transfers preflight, in-flight and post-flight data between the DTC and the MDP.

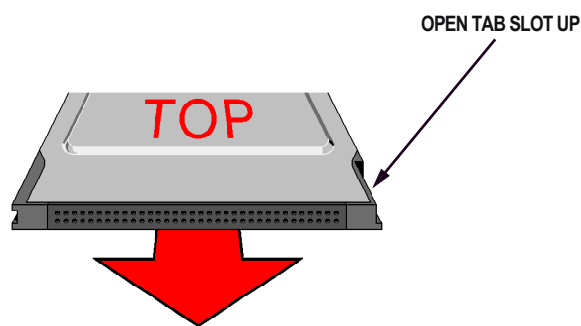

T38002-594-1-020
Figure 1-262. Data Transfer Cartridge

DTS CONTROLS AND DISPLAYS

The MFD DTS Display Page allows for control and display of the DTS functions by pressing DTS (MB-6) on the MFD MENU Display Page. If a DTC is not inserted in the DTD, NO CASSETTE is displayed in the title window of the MFD DTS Display Page and control of the DTS is unavailable. Pressing DTS (MB-6) on the LOAD TO MDP, LOAD TO DTD, LOAD OP 1, or LOAD OP 2 Display Pages returns to the DTS Display Page.

NOTE

- After a short power interruption, the title window may show a DTS status of DTS OFF. The DTS recovers within 10 seconds.
- Short power interruptions may cause the title window display to change to NO CASSETTE.

- An electrical static discharge between the pilot and the DTS when inserting the DTS may cause DTS errors, resulting in NO CASSETTE or DTS OFF displayed in the title window. Removing and reinserting the cassette should reset the display. If NO CASSETTE still appears, aircraft power must be cycled.

PREFLIGHT PLANNED MISSION DATA TRANSFER FROM DTC TO MDP

Preflight planned mission data is loaded onto the DTC via the mission planning system. The data is then transferred from the DTC to the MDP by the aircrew via the DTD and MFD.

MFD LOAD TO MDP DATA TRANSFER PAGES

The LOAD TO MDP Display Page, Figure 1-263, is selected by pressing LOAD TO MDP (ML-3) on the DTS Display Page. Data transfer selections are divided into two groups:

- Operational data transfer options for aircrew use/update:
 - OPERATIONAL 1
 - OPERATIONAL 2
 - ALL (EX ICAO)
- Maintenance data transfer option for maintenance crew use/update:
 - MAINTENANCE

Pressing OPERATIONAL 1 (ML-3), OPERATIONAL 2 (ML-4), or MAINTENANCE (MR-3) selects that data transfer page. These pages include options that indicate the types of data to be transferred. The titles of available data (data which have not yet been transferred) are green and underlined. Data transfer is accomplished by pressing the OSB adjacent to a title. When pressed, and during the data transfer, the title blinks. Upon successful completion of data transfer, the title turns steady green and the underlines are removed. The title turns back to underlined on the next MDP powerup or next DTC insertion. If data is not available for transfer (not loaded on the DTC), or if the data transfer fails, the option turns red and is crossed out by a horizontal

T.O. 1T-38C-1

DTS

line. The pilot can re-attempt the transfer regardless of the state of the previous transfer or color of the option.

Pressing ALL (EX ICAO) option at MR-7 initiates data transfer of all data available for transfer under OPERATIONAL 1 and OPERATIONAL 2 except ICAO.

When a transfer to the MDP is initiated that includes DST, APP, ICAO or FPL data, the PNS changes to EGI, the steerpoint changes to DEST 200, and the UFCP changes to the Basic Menu Display.

WARNING

Attempting to load ICAO data causes the MDP to freeze the attitude displays (EADI and HUD) and data processing for approximately 80 seconds. Take-off should not be initiated during the 80 seconds.

NOTE

- ICAO loading can only be initiated with WOW.
- Yaw damper disengages during ICAO data download.

MFD LOAD OP 1 DISPLAY PAGE

The LOAD OP 1 Display Page, Figure 1-264, provides options for transferring data that is updated every flight as follows:

- a. WPN (ML-4) - Pressing ML-4 transfers weapon data that includes the ability to disable A/A and A/G modes.
- b. FPL (ML-5) - Pressing ML-5 transfers flight plans.
- c. ALERT (ML-6) - Pressing ML-6 transfers Bingo fuel and Altitude Alerts.
- d. CLOCK (ML-7) - Pressing ML-7 transfers the delta hours from GMT to adjust to local time.
- e. ALL (MR-7) - Pressing ML-7 transfers all data listed above if available.

MFD LOAD OP 2 DISPLAY PAGE

The LOAD OP 2 Display Page, Figure 1-265, provides options for transferring data that is less frequently updated:

- a. APP (ML-3) - Pressing ML-3 transfers approach patterns, parameters, and DST numbers.
- b. DST (ML-4) - Pressing ML-4 transfers DST points (not including ICAO and FPL points).
- c. ICAO (ML-5) - Pressing ML-5 transfers ICAO points.
- d. ZONE (ML-6) - Pressing ML-6 transfers Training and No-Fly Zones.
- e. TCAS (ML-7) - Pressing ML-7 transfers EMER and VFR codes.
- f. UHF (MR-3) - Pressing MR-3 transfers UHF radio channel/presets.
- g. VHF (MR-4) - Pressing MR-4 transfers VHF radio channel/presets.
- h. DCL (MR-5) - Pressing MR-5 transfers HUD and MFD Declutter settings.
- i. MAP (MR-6) - Pressing MR-6 transfers HSD Map Symbols.
- j. ALL EX ICAO (MR-7) - Pressing MR-7 transfers all data listed above if available except ICAO.

DIGITAL AERONAUTICAL FLIGHT INFORMATION FILE (DAFIF)

Mission data that use the DAFIF are tagged with the data expiration date as transferred to the MDP (DTD data date). DST points, ICAO points, Training/No-Fly zones (ZONE), and Flight Plans (FPL) are shown with two date fields, the current MDP data date and the DTD data date.

When the data is transferred to the MDP, the MDP data date field is updated to match the DTD data date on the LOAD OP 1, LOAD OP 2, and the LOAD TO MDP Display Page. If a flight plan is edited in the aircraft by the aircrew, the MDP data date remains unchanged unless data from DST or ICAO is used. If a flight plan is edited by the aircrew using DST or ICAO points, the FPL MDP data date is updated to the MDP data date that expires first among DST, ICAO, and FPL.

Cautions are not generated if the current date exceeds the DAFIF dates for FPL, DST, ICAO, or ZONE data.

The DTC and/or MDP data dates will display NO DATE for any of the DST, ZONE, or FPL data that are mission planned without using DAFIF.

The DTC and/or MDP data dates will display NO FILE when any of the DST, ZONE, FPL, or ICAO data is missing.

INFLIGHT AND POST FLIGHT DATA TRANSFER FROM MDP TO DTC

There are four types of data that can be transferred from the MDP to the DTC.

- a. Mission debrief data, referred to as, Air Combat Maneuvering Instrumentation (ACMI)
- b. Flight loads data
- c. General aircraft data
- d. Engine data

ACMI and flight loads data is continuously recorded directly to the DTC during flight (in flight data). General aircraft data and engine data is automatically transferred to the DTC after landing (post flight data). General aircraft event data and engine data can also be selected for transfer via the MFD.

The LOAD TO DTD Display Page, Figure 1-266, allows the option of initiating data transfer from the MDP to the DTC and provides status of data transfer in the LOAD TO DTD Display Page status window as follows:

- a. DTS IDLE indicates that the MDP is not reading or writing to the DTC.
- b. DTS ACTIVE indicates that the MDP is reading or writing to the DTC.
- c. DOWNLOAD COMPLETE indicates that a download data transfer is complete and it is safe to remove the DTC.
- d. DOWNLOAD ERROR indicates that an error was encountered during automatic data transfer.

INFLIGHT DATA RECORDING

ACMI and flight loads data is recorded to the DTC real time throughout the flight, starting with the first forward movement of the A/C and stopping 30 seconds after landing. While data is being recorded, DTS ACTIVE is displayed on the MFD LOAD TO DTD Display Page. When recording has stopped, an automatic post flight data transfer from MDP to DTC is started.

NOTE

- Failure to insert a DTC at the start of the mission, or ejecting the DTC during flight, results in loss of ACMI and flight loads data.

- Loading mission data in-flight temporarily suspends in-flight data recording, resulting in the loss of ACMI and flight loads data for the duration of the mission data transfer.

AUTOMATIC POST FLIGHT DATA TRANSFER FROM MDP TO DTC

Automatic data transfer of the flight's data is initiated 30 seconds after landing. Landing is defined as WOW and speeds below 60 KCAS. After 30 seconds the status indicates DTS IDLE for 10 seconds, then DTS ACTIVE for approximately 20 seconds, then DOWNLOAD COMPLETE is displayed. DOWNLOAD COMPLETE remains displayed until the cartridge is removed, MDP power is cycled, or an aircrew initiated data transfer is performed. The following data is transferred to the DTC after landing:

- a. No Drop Bomb Scoring (NDBS)
- b. Over g events and value
- c. Engine data
- d. MFL/PFL
- e. MARK points

NOTE

- The pilot should not eject the DTC until the DOWNLOAD COMPLETE indication is displayed on the MFD LOAD TO DTD Display Page.
- If DOWNLOAD ERROR is displayed on the LOAD TO DTD Display Page after landing, then an aircrew initiated download LAST should be attempted.

AIRCREW INITIATED POST FLIGHT DATA TRANSFER FROM MDP TO DTC

Pressing LAST (MR-3) transfers engine data that is stored in the MDP from the time that MDP power was applied. Pressing ALL (MR-4) transfers all engine data stored in the MDP to the DTC. All of the general aircraft data stored in the MDP is transferred to the DTC during either a LAST or ALL data transfer.

NOTE

- For ground aborts, automatic data transfer is not accomplished. Aircrew

T.O. 1T-38C-1

DTS

initiated download LAST is recommended to facilitate debriefing.

- An aircrew initiated download should not be performed if DOWNLOAD COMPLETE is displayed after flight.

INITIATION AND TERMINATION OF DATA RECORDING

Automatic recording of general aircraft data (NDBS, over *g* events, MFL/PFL, and MARK points) is initiated on MDP powerup. The recording of general aircraft data can not be terminated. Automatic engine

recording is initiated with WOW and RPM greater than 2 %, or if manually terminated, with weight-off-wheels and speeds greater than 160 KCAS.

When engine data is being recorded, STOP is displayed at ML-4 on the DTS display. The aircrew can stop recording by pressing ML-4. When engine data is not being recorded, START is displayed at ML-4. The aircrew can initiate recording by pressing ML-4. STOP is not available when airborne. Engine data recording is also terminated when transferring data to the DTD (manual selection of LAST or ALL, or automatic data transfer after landing).

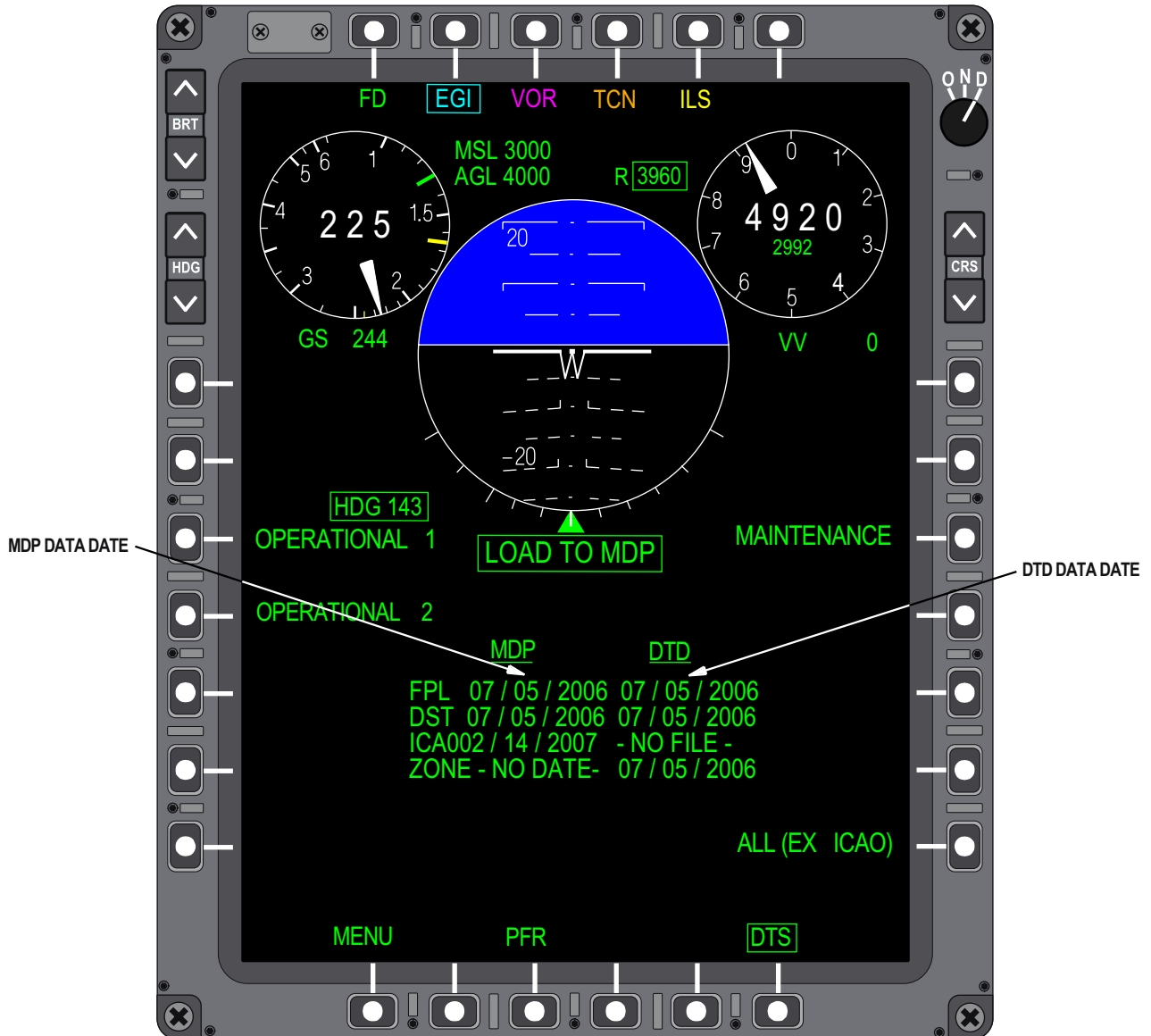

Figure 1-263. LOAD TO MDP Display Page

T38002-578-1-020



Figure 1-264. LOAD OP 1 Display Page

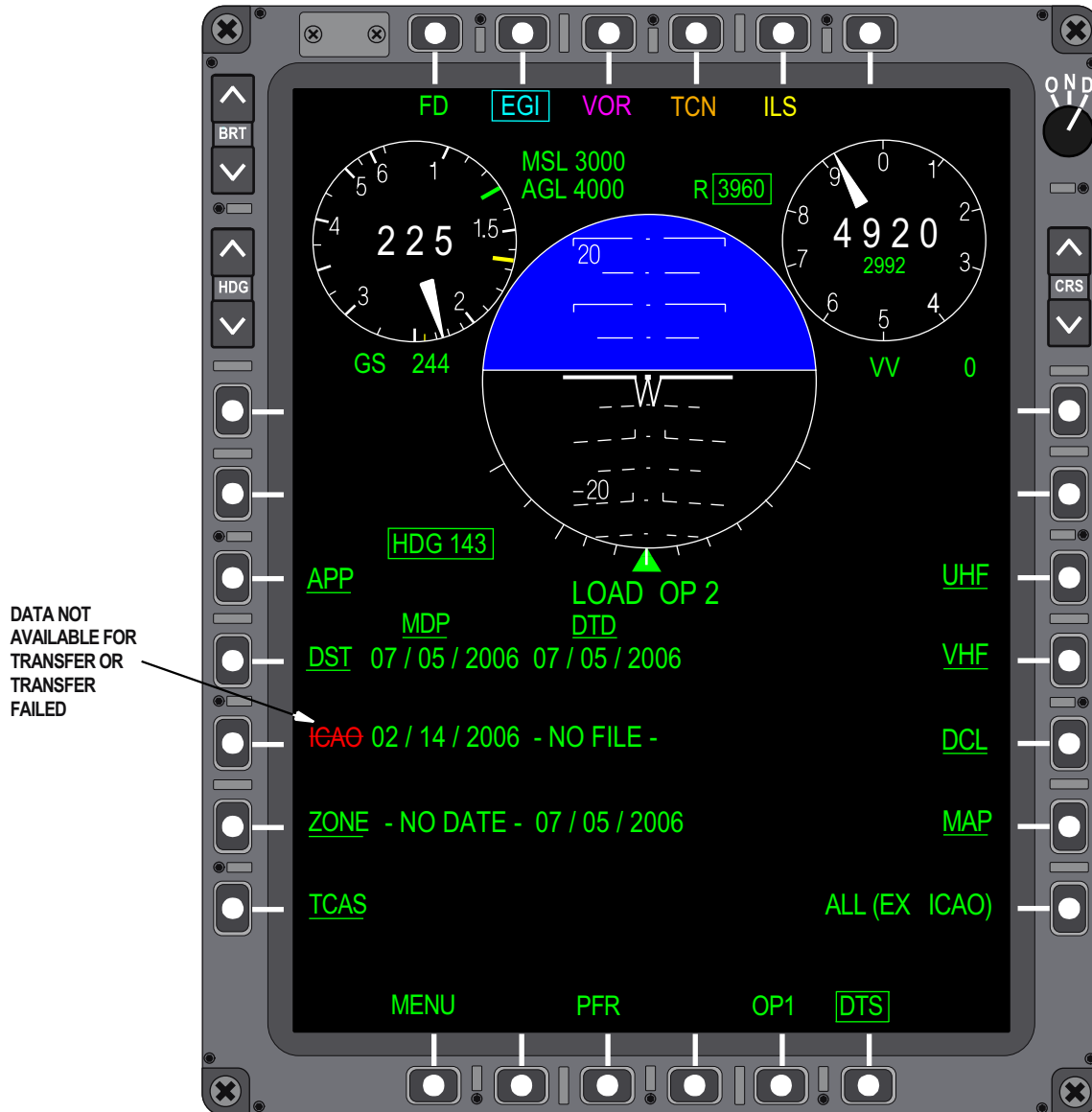

Figure 1-265. LOAD OP 2 Display Page

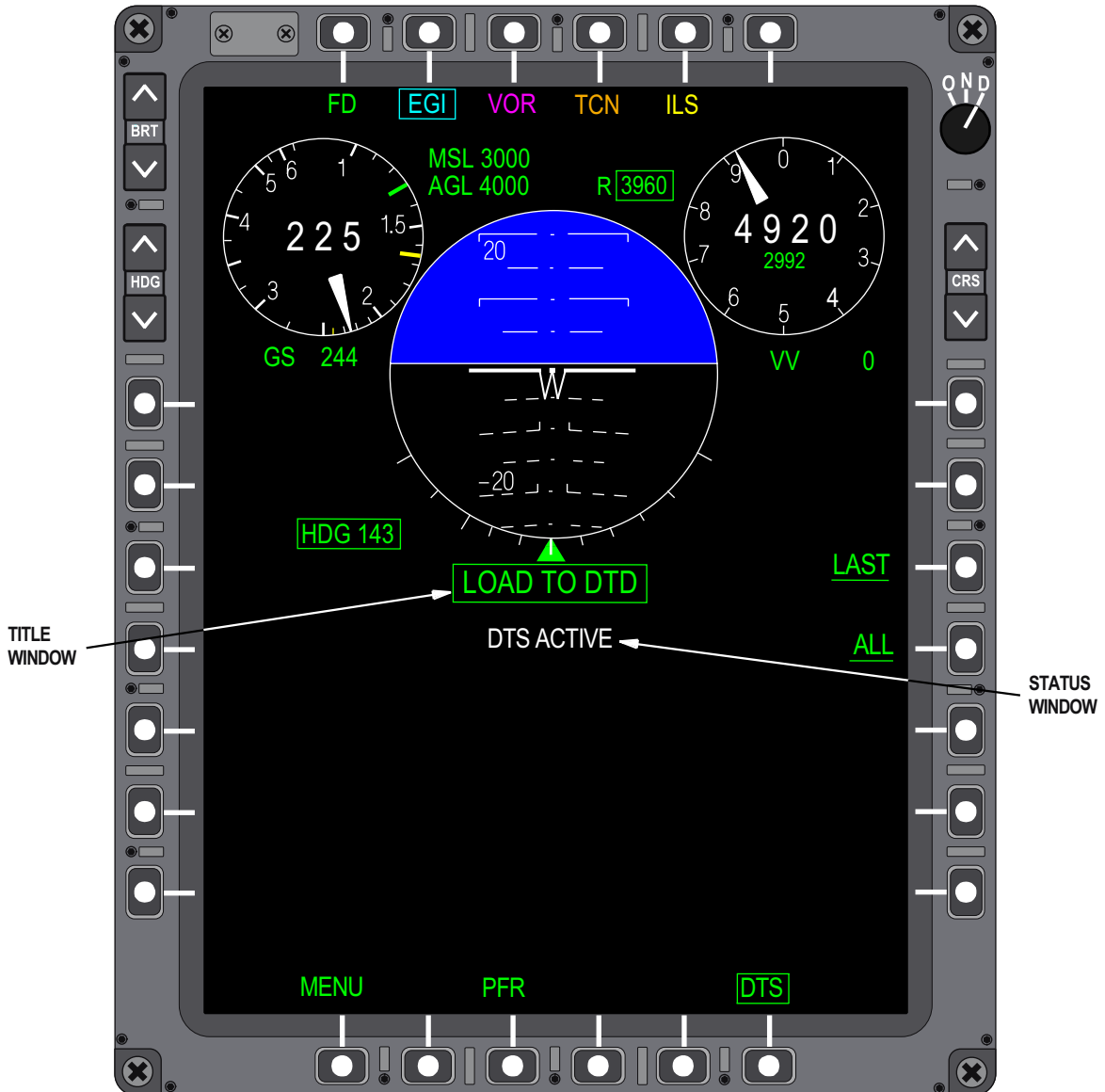

Figure 1-266. LOAD TO DTD Display Page

VIDEO TAPE RECORDER (VTR)

VTR SYSTEM OVERVIEW

The VTR, located in the right side of the RCP (Figure 1-267), has the capability to record either the FCP or RCP MFD, the HUD symbology with outside view through the HUD, or a combination of the FCP MFD and HUD. The VTR records at 30 frames per second.

Recording is initiated manually by the pilot or automatically. Refer to VTR AUTOMATIC RECORDING, this section. During recording, all audio signal inputs are recorded by the VTR at the volume level set by the FCP ACP I/C Volume Control Knob. The VTR is controlled by the MDP via the UFCP. Refer to UFCP FUNCTION KEYS, this section. The green VTR LED located on the UFCP above the VTR Function Key is illuminated during recording.

NOTE

- In bright sunlight, it is sometimes difficult to determine if the VTR LED is illuminated. To verify VTR recording, select the UFCP VTR Function Key and verify an asterisk is displayed next to the selected recording mode.
- If the MDP is turned OFF before STOP is commanded via the UFCP, and aircraft electrical power is not interrupted, the VTR will automatically stop and unthread the cassette.
- If the MDP is not operational, VTR recording is unavailable.



The VTR must be properly shutdown or the VTR tape will remain threaded and cannot be removed. Improper removal of the VTR tape will result in VTR and tape damage.

VTR OPERATING MODES

There are two basic VTR modes of operation: STOP and RECORD.

- | | |
|------|--|
| STOP | This is the powerup default mode when a Hi 8 MM cassette has been properly inserted into the VTR. Selecting STOP via the UFCP VTR Key Display while recording causes the VTR to stop recording and unthread the tape (unthreading takes 4 to 5 seconds to complete). |
| REC | Recording Modes are selected via the UFCP VTR Key Display. An asterisk indicates the specific mode of operation selected. Switching from STOP to REC takes 4 to 5 seconds to thread the tape and begin recording. |

VTR RECORDING MODES

The VTR records in one of the following modes:

- a. HUD* - Records HUD symbology with the outside view through the HUD.
- b. MFD*F - Selected via the FCP UFCP records the front cockpit's MFD.
- c. MFD*B - Selected via the RCP UFCP records the rear cockpit's MFD.
- d. CMB* (Combination) - Records the HUD and the FCP MFD by continuously alternating time; 6 seconds of HUD video and 0.6 second of FCP MFD video.

VTR CONTROLS AND DISPLAYS

The VTR is controlled via the UFCP VTR Key Display. The Access Knob on the VTR is used to load/unload the cassette. The Mode Knob and Toggle Switch are disconnected (non-operational). The cassette cannot be fast forwarded or rewound in the aircraft. The cassette is loaded/unloaded from the VTR by rotating the Access Knob counter clockwise to PULL OPEN, opening the door, and loading/unloading the cassette (Figure 1-268). This can be done only when the VTR is in STOP mode.

T.O. 1T-38C-1
VTR

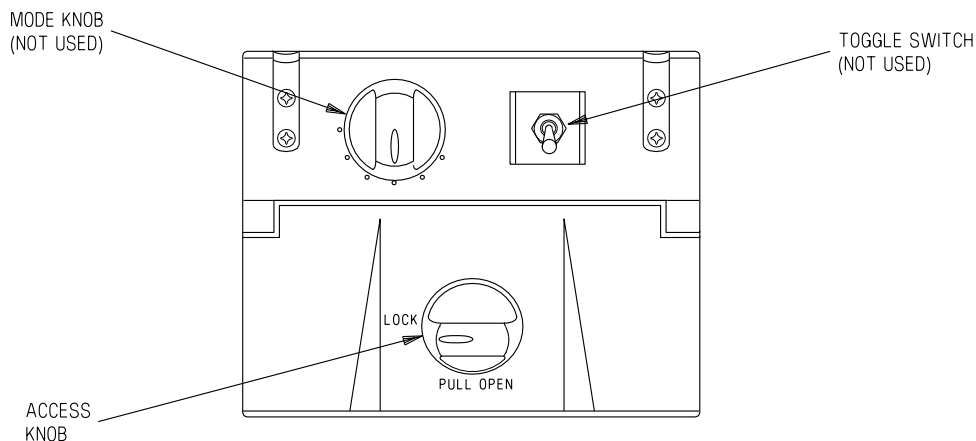

T38002-220-1-020

Figure 1-267. Video Tape Recorder

After loading the cassette, close the door and rotate the Access Knob clockwise to LOCK.



The cassette must be fully seated with the write protect tab facing forward and the drive sprockets facing outboard before closing the cassette Loading Door. Excessive force is not required to close the door and will cause internal damage to the VTR. Never attempt to manually remove a cassette that is threaded in the VTR.

NOTE

Reusing cassettes for more than 20 missions contaminates the VTR and degrades recording quality. The 20 mission limitation is based on transporting the cassette in an appropriate protective case.

UFCP VTR Display Indications

In addition to recording modes, the UFCP VTR Key Display provides the following indications:

- a. CHECK CASSETTE
- b. OFF/WRITE PROTECTED CASSETTE

Refer to UP FRONT CONTROL PANEL, this section.

COLOR TV SENSOR SYSTEM (CTVS)

The CTVS (HUD Camera) sends video of the HUD symbology and outside view to the MDP for recording. The cockpit CTVS field of view is 22° vertical and 17° horizontal, ranging from the upper limit of

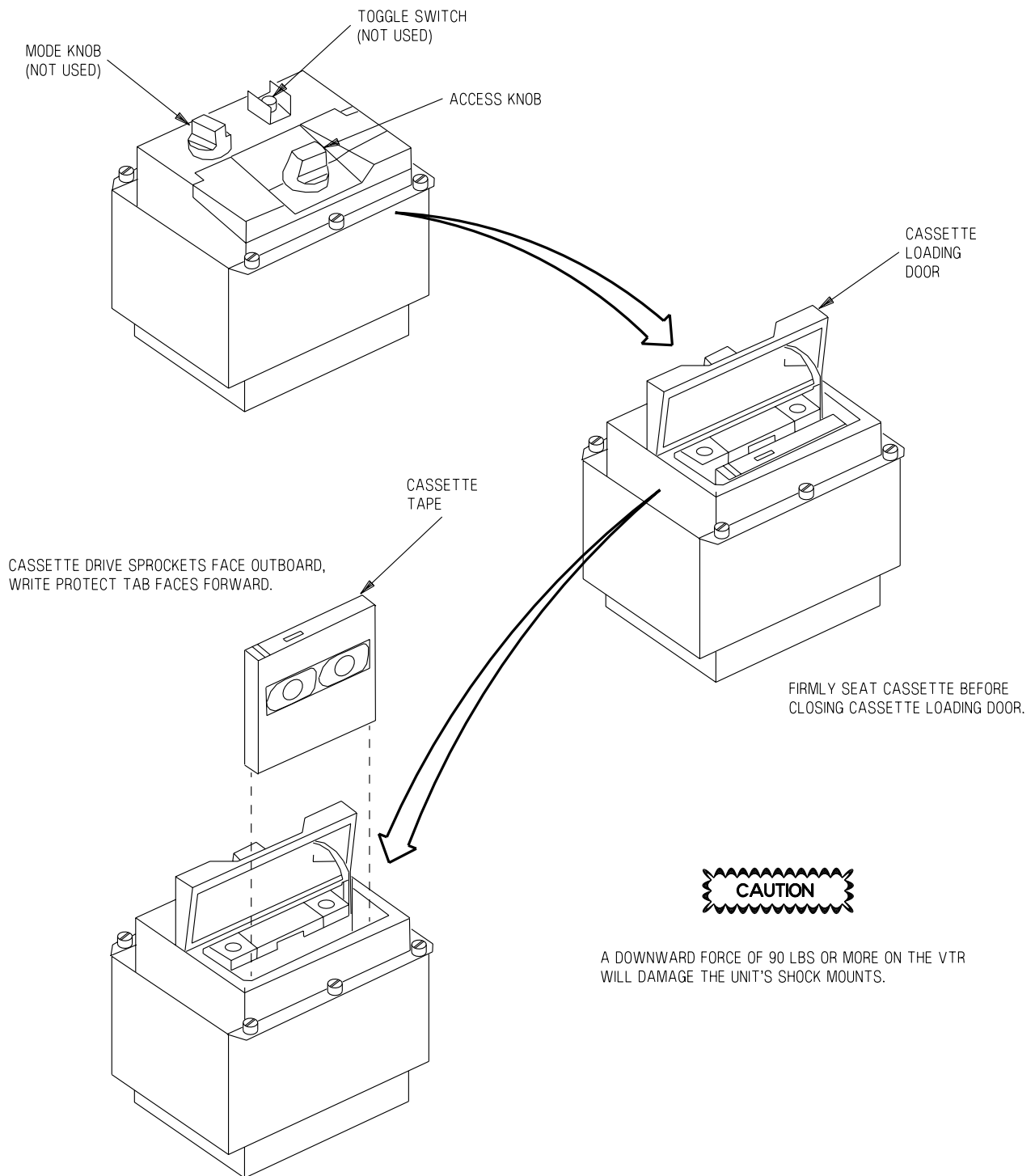

Figure 1-268. VTR Loading/Unloading

T38002-572-1-020

T.O. 1T-38C-1

VTR

the HUD TFOV to 2° below the lower limit of the HUD TFOV.

NOTE

Iris response time for the CTVS (HUD camera) is such that brightness fluctuations can be seen on the HUD video when viewed on the MFD or on the videotape.

CTVS MARK

When the trigger, pickle button, or WIT function key is pressed, a video mark (black rectangle located on middle right side of video) is added to the CTVS recording of the HUD as follows:

a. In A/A master mode, the mark appears at the moment the pickle button/trigger is pressed and lasts for the duration.

b. In A/G master mode, the mark functions as follows:

- (1) Pickle button actuation - The mark appears with the weapon release command (i.e., zero time to release in CCIP or CCRP, or immediately in MAN) and continues during the release command time.
- (2) Trigger actuation - The mark appears the moment the trigger is pressed and lasts for the duration.

c. In any master mode, pressing the WIT Function Key marks the tape for 1.5 seconds.

Refer to T.O. 1T-38C-34-1-1

MFD WITNESS MARK

When the UFCP WIT Function Key is pressed, the witness mark (white triangle) is displayed for 1.5 seconds in the upper right corner of the active MFD except when the HUD view or EED is being displayed on the MFD.

VTR AUTOMATIC RECORDING

HUD Automatic Recording

NAV Master Mode - The VTR starts to record the HUD when the pickle button or trigger is pressed regardless of the Master Arm Switch position or WOW status and continues until the pickle button or

trigger is released. When the pickle button or trigger is released, the VTR will immediately return to the previous recording mode (STOP, MFD, or CMB).

A/A or A/G Master Mode - The VTR starts to record the HUD when the pickle button or trigger is pressed with weight-off-wheels, regardless of the position of the Master Arm Switch. Automatic recording of the HUD is not enabled if WOW. Automatic HUD recording will begin immediately upon pressing the pickle button/trigger and will continue to record until approximately 5 seconds after release of the pickle button/trigger. After automatic HUD recording, the VTR will return to the previous recording mode (MFD or CMB).

NOTE

In A/A or A/G master mode, automatic HUD recording will not occur from STOP mode.

MFD Automatic Recording

In A/G Master Mode, an A/G event (bomb release or gun firing) will result in the automatic recording of the FCP MFD for three seconds at which time the scoring menu appears. At the end of three seconds the previously selected recording mode (HUD or CMB) returns.

NOTE

MFD automatic recording will not occur from the STOP mode.

STANDBY INSTRUMENTS

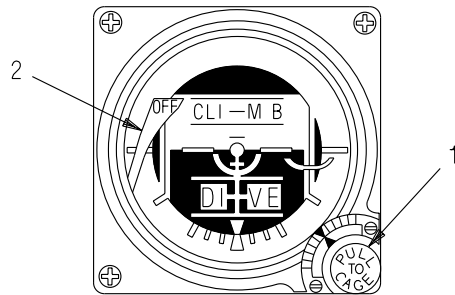

1. PULL TO CAGE/PITCH TRIM KNOB
2. OFF FLAG

T38002-26-1-020

Figure 1-269. Standby Attitude Indicator

STANDBY ATTITUDE INDICATOR

A standby attitude indicator is located on the instrument panel in both cockpits and provides an attitude indicating system if the primary flight reference system malfunctions. The attitude indicator (Figure 1-269) has internal white lighting, is self-contained, and provides a visual indication of the bank and pitch of the aircraft. The instrument limits are: 92° climb and 78° dive with full 360° roll capability. The pitch and bank erection system reduces turning errors to a minimum. Acceleration and deceleration cause slight errors in pitch indications, which are most noticeable on takeoff. Pitch and roll attitudes are shown by the circular motion of a universally mounted sphere displayed as the background for a miniature reference aircraft. The miniature reference aircraft is always in proper physical relationship to the simulated earth, horizon, and sky areas of the background sphere. On the sphere, the horizon is represented by a solid fluorescent line, the sky by a light gray area, and the earth by a dull black area.

Rotating the pitch trim knob (located on the lower right side of the instrument) adjusts the miniature aircraft. This adjustment is necessary since the level flight attitude of the aircraft varies with weight and speed. Pulling the knob out to the fully extended position cages the indicator. With the knob fully extended, rotating the knob fully clockwise locks the

indicator in the cage position until released. Approximately 3 minutes are required to erect to true vertical after power is applied to the system. The indicator should be uncaged and set after applying electrical power and left uncaged during flight. It should be caged prior to removing electrical power after flight. When power is interrupted or the indicator is caged, the OFF warning flag appears on the face of the indicator. It provides a minimum of 9 minutes of useful attitude information after power failure (accurate to within $\pm 6^\circ$). Power is supplied by the Left Essential 28 VDC Bus.

WARNING

The indicator can precess following sustained acceleration or deceleration periods and can tumble during maneuvering flight near the vertical.

CAUTION

For solo flight, the RCP Standby Attitude Indicator should be uncaged. There is a risk of damage during flight in the caged and locked condition. Avoid snap releasing the pitch trim knob after uncaging to prevent damage to the indicator.

Attitude Warning Flag

The attitude warning flag (OFF) appears whenever electrical power to the system has failed or is interrupted. The flag also appears during initial application of electrical power for approximately 1 minute.

WARNING

- There is no warning of attitude sphere malfunctions other than power failure.
- The attitude warning flag does not appear with a slight electrical power reduction or failure of other components within the system. Failure of certain components can result in erroneous or complete loss of pitch and bank presentations without a visible flag. It is

T.O. 1T-38C-1
STBY INST

imperative that the attitude indicator be cross checked with other flight instruments when under actual or simulated instrument conditions.

NOTE

During high G maneuvering the warning flag can appear without system malfunction.

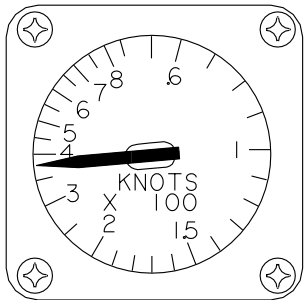

T38002-221-1-020

Figure 1-270. Standby Airspeed Indicator

STANDBY AIRSPEED INDICATOR

The standby airspeed indicator (Figure 1-270) is located on the instrument panel in both cockpits, has internal white lighting, and provides KIAS as a function of the difference between pitot and static pressures. Airspeed is indicated by the pointer on the face of the instrument. The standby airspeed indicator displays airspeed from 60 to 850 KIAS. The standby airspeed indicator has a tolerance of ± 9 knots at 150 KIAS, ± 20 knots at 400 KIAS.

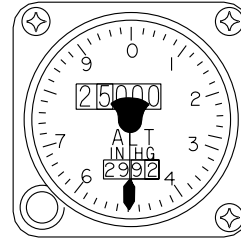

T38002-222-1-020

Figure 1-271. Standby Altimeter

STANDBY ALTIMETER

The standby altimeter (Figure 1-271) is a pneumatic counter-drum-pointer altimeter located on the instrument panel in each cockpit. It is equipped with internal white lighting. It is a precision pressure altimeter displaying uncorrected altitude. Direct readout of the altitude is accomplished by the numbers on the 10,000-foot counter and 1000-foot counter on the face of the instrument. A single pointer indicates hundreds of feet around the fixed circular scale. The 100-foot pointer serves as a precise readout of values less than 100 feet. Below an altitude of 10,000 feet, a diagonal warning symbol appears on the 10,000-foot counter. FCP and RCP altimeters operate independently of each other.

A barometric pressure set knob inserts the desired altimeter setting in inches of Hg. Rapid rotation of the barometric pressure set knob or use of excessive force to overcome binding of the knob can cause internal gear disengagement or gear failure, resulting in altitude indication errors. In operation, the Left Essential 28 VDC Bus powered vibrator is automatically energized to remove the friction from the counter-drum-pointer mechanism, decreasing the lag in the altimeter indications.

WARNING

- If the altimeter internal vibrator is inoperative, due either to internal failure or DC power failure, the 100-foot pointer can momentarily hang up when passing thru 0 (12 o'clock position). If the vibrator has failed, the 100-foot pointer hang up can be minimized by tapping the case of the altimeter.
- Because the altimeter displays uncorrected altitude, the installation error corrections from Appendix A1 or B1 must be used to correct the aircraft altitude. Each standby altimeter has a tolerance of ± 75 feet when checked against a known elevation point on the ground, ± 100 feet at a pressure altitude of 5,000 feet, and ± 270 feet at a pressure altitude of 20,000 feet. FCP and RCP altimeters are checked independently of each other.

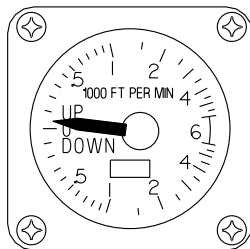

T38002-224-1-020

Figure 1-272. Standby VVI

STANDBY VERTICAL VELOCITY INDICATOR (VVI)

The standby vertical velocity indicator (Figure 1-272) is located on the instrument panel in both cockpits and displays the rate of climb or dive of the aircraft. The indicator ranges from 0 to $\pm 6,000$ fpm. The VVI has a tolerance of ± 100 fpm, a rate of change greater than 20,000 fpm will cause internal damage to the VVI. Zero indication is at the 9 o'clock position on the dial. The top half of the dial indicates climb and the bottom half indicates descent, with the dial rotating clockwise (to indicate climb) or counterclockwise (to indicate descent).

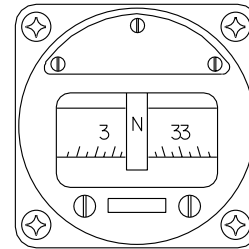

T38002-223-1-020

Figure 1-273. Standby Compass

STANDBY COMPASS

The standby compass (Figure 1-273) is a magnetic compass which continuously displays aircraft heading with reference to the earth's magnetic field with a $\pm 5^\circ$ tolerance.

The standby compass case is filled with compass liquid. The case contains a lubber line, two needle magnets, and a card element attached to a jewel pivoted float. The card is graduated in $\pm 5^\circ$ increments to represent horizontal angles. The cardinal headings are indicated by N, E, S, and W and every $\pm 30^\circ$ is labeled. Two adjustable permanent bar magnets are under the lower cover; these magnets compensate for deviations. A compass correction card is in a card holder on the forward right canopy rail.

LIGHTING EQUIPMENT

INTERIOR LIGHTING

INSTRUMENT LIGHTS

The instrument lights operate on the left AC bus. The INSTRUMENTS rheostat, on the lighting control panel located on right console of each cockpit, controls operation and intensity of the following:

- a. Standby Instruments lights.
- b. Standby Compass light (FCP only).
- c. Cabin Pressure Indicator light (FCP only).
- d. Hydraulic Pressure Indicators lights.
- e. ACP panel lights.
- f. EED and MFD Bezel lights.
- g. UFCP keys/OSBs.
- h. UHF and NAV Backup Control Panels (FCP only).
- i. INDEXER LIGHTS panel light.
- j. Landing Gear Control panel lights.
- k. Master Arm Switch/CMD Switch/MARKER BEACON panel lights (FCP only).
- l. TAKE COMMAND Switch/MARKER BEACON panel lights (RCP only).

INSTRUMENT PANEL MAP LIGHTS (AFTER T.O. 1T-38C-548)

Two instrument panel map lights are installed under the left and right windshield arch in the FCP and two in the RCP. These lights swing out from their stowed position and are turned on when positioned 17° or more from the stowed position. Once turned on, rotating the bezels varies lighting brightness. Returning the lights to within 17° of their stowed positions turns the lights off. These lights are powered by the left essential DC bus.

FLOOD LIGHT

Six white floodlights, operating on the right AC bus, aid in illuminating the instrument panel, left and right console panels and the cockpit area. The floodlights are controlled by the FLOOD rheostat on the lighting control panel located on the right console of each cockpit. The two floodlights over each cockpit instrument panel automatically switch from AC to the left essential DC bus if the AC supply fails, provided the FLOOD rheostat is out of the OFF

position. These floodlights serve as a lighting source under this condition and cannot be dimmed when operating on DC power.

CONSOLE LIGHTS

The left and right console, sub-panels, AAP internal white lights, and pedestal lights operate on the left AC bus. Operation and intensity of these lights are controlled by rotating the CONSOLE rheostat on the lighting control panel located on the right console of each cockpit.

NOTE

If the left generator and bus transfer relay fail, instrument and console lights are not operational. Floodlights which are powered by the right AC bus are not automatically available, and the FLOOD rheostat must be adjusted to obtain cockpit lighting.

UTILITY LIGHTS

Two removable utility lights, one in each cockpit, are normally mounted on the right console aft of the map case in the FCP and on the right side of the main instrument panel in the RCP. Each light is controlled by a rheostat located on the aft portion of the light. Each light can be removed from the mounting bracket and is equipped with a spring extension cord, enabling use anywhere in the cockpit, or it can be placed in various other mounting brackets in the cockpit. The lights operate on the left essential DC bus.

WARNING

Stow the utility lights after use to prevent interference with ejection seat and man-seat separator system.

EXTERIOR LIGHTING

The following exterior lighting can only be controlled from the front cockpit.

ROTATING BEACON LIGHTS

One rotating beacon light is located near the top of the vertical stabilizer and one on the lower fuselage. The lights operate on the left AC bus and are controlled by the BEACON light switch on the FCP lighting control panel located on the right console.

POSITION LIGHTS

The position lights operate off the left AC bus and are individually located in each wingtip, in the vertical stabilizer, and in the lower fuselage. The position lights are controlled by the POSITION (BRIGHT/OFF/DIM) switch on the lighting control panel located on the right console.

FORMATION LIGHTS

Formation lights, operating on the left essential DC bus, are individually located on each side of the forward nose section. Formation lights are controlled by the FORMATION light switch on the lighting control panel located on the right console.

LANDING-TAXI LIGHT

A single, retractable, landing-taxi light with dual filaments operates on the left AC bus. When the POSITION lights switch is in BRIGHT or DIM and the gear is extended, the landing-taxi light extends. The LDG TAXI LIGHT light switch on the left sub-panel controls only the filament power. When the weight of the aircraft is off the main gear and the LDG TAXI LIGHT switch is ON, both filaments are illuminated. When the weight of the aircraft is on the main gear, the light moves to the taxi position and one filament is extinguished. Turning the POSITION lights switch to the OFF position retracts the landing-taxi light in approximately 10 seconds.

WARNING/CAUTION/ADVISORY (WCA) SYSTEM

The WCA system consists of individual cockpit indicators, MDP generated messages displayed on the MFD and HUD, and MDP generated tones.

WARNING/CAUTION/ADVISORY (WCA) INDICATORS

The WCA individual cockpit indicators include the following:

- a. Caution Light Panel
- b. MASTER CAUTION light
- c. Right and left engine FIRE warning lights
- d. CANOPY warning light
- e. Landing gear warning light
- f. Landing gear position indicator lights
- g. AOA indexer lights
- h. BOOST PUMPS indicator lights
- i. CROSSFEED indicator light
- j. MARKER BEACON
- k. TAKE OFF TRIM

CAUTION LIGHT PANEL

The Caution Light Panel (Figure 1-274) on the right side of each cockpit instrument panel alerts crewmembers of individual system malfunctions or status changes. The caution light system monitors 5 of the aircraft systems (Hydraulics, Electrical, Fuel, Oxygen and Engine Anti-Ice).

All caution lights are amber. Each caution light (except the ENG ANTI-ICE ON light) remains illuminated as long as the malfunction exists or system status is unchanged. The ENG ANTI-ICE ON light illuminates when the ENG ANTI-ICE switch is ON or with loss of the right AC bus without crossover. The caution lights do not go out if the MASTER CAUTION light is reset.

MASTER CAUTION LIGHT

An amber MASTER CAUTION light is located on the left side of each instrument panel. When a light on the caution light panel illuminates, the MASTER CAUTION light also illuminates. When the condition is corrected, the MASTER CAUTION light automatically goes out. If the condition cannot be corrected, pressing the MASTER CAUTION light causes it to go out and resets it to provide warning of subsequent malfunctions.

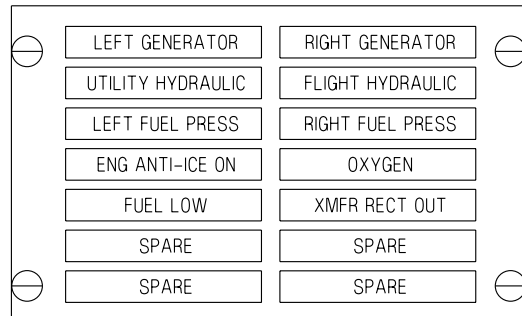

T38002-6-1-020

Figure 1-274. Caution Light Panel

FIRE WARNING LIGHTS

There are two red fire warning lights, placarded FIRE, one for each engine, on the instrument panel in each cockpit. Together with the HUD and MFD displays, they warn of an overheat or fire condition in their respective engine compartment. Refer to FIRE WARNING AND DETECTION SYSTEM, this section.

CANOPY WARNING LIGHT

A canopy warning light, placarded CANOPY, is located on the right instrument panel of each cockpit. When either canopy is unlocked, both canopy warning lights illuminate. Refer to CANOPY OPERATION, this section.

LANDING GEAR WARNING LIGHT

The landing gear warning light consists of a red light within the wheel shaped end of each landing gear lever. Refer to LANDING GEAR CONTROLS, this section.

LANDING GEAR POSITION INDICATOR LIGHTS

Three green landing gear position indicator lights on each instrument panel illuminate when the gear is down and locked. Refer to LANDING GEAR CONTROLS, this section.

AOA INDEXER LIGHTS

Refer to ANGLE OF ATTACK (AOA) SYSTEM, this section.

BOOST PUMP INDICATOR LIGHTS

Two fuel boost pump indicator lights, one for the left system placarded LEFT OFF and one for the right system placarded RIGHT OFF, are located on the right sub-panel of the RCP. An indicator light illuminates when the corresponding boost pump switch is OFF. Refer to FUEL SYSTEM, this section.

CROSSFEED INDICATOR LIGHT

A crossfeed indicator light, placarded CROSSFEED ON, is located on the right sub-panel of the RCP. When the CROSSFEED switch is ON, the crossfeed indicator light illuminates.

MARKER BEACON LIGHT

The MARKER BEACON light is installed on the left side of the main instrument panel in both cockpits. The MARKER BEACON lights flash to signify marker passage in accordance with marker type (outer, middle, or inner). Refer to GROUND BASED NAVIGATION, this section

TAKEOFF TRIM LIGHT

A green TAKE OFF TRIM indicator light is installed on the left console in both cockpits. When the TAKE OFF TRIM button is pushed and held, the trim motor moves the control stick to the required position at which point the motor stops and the lights illuminate. Refer to FLIGHT CONTROL SYSTEM, this section

WARNING/CAUTION/ADVISORY (WCA) LIGHTS CONTROLS

WARNING BRIGHT/DIM SWITCH

The three-position switch, spring-loaded to the neutral (unmarked) position, is located on the right console of each cockpit and is placarded WARNING BRIGHT/DIM. In DIM, all WCA lights except the fire warning, MARKER BEACON light and takeoff trim indicator lights go to dim mode. With the INSTRUMENTS rheostat out of OFF, placing the BRIGHT/DIM switch to DIM switches the power source from DC to AC, providing the dim mode in

that cockpit. Placing the switch to BRIGHT or placing the INSTRUMENTS rheostat to OFF returns the lights to bright mode.

WARNING TEST SWITCH

The landing gear warning tone, fire detection system, AOA indexer lights, and all WCA lights, except the takeoff trim indicator lights, may be tested by moving the spring-loaded WARNING TEST switch on the right console lighting control panel in either cockpit to TEST.

The WARNING TEST switch also generates a repeated sequence of five tones (Weapon Release, Stall, MAX G, Altitude, and Gear) for as long as the TEST switch and the landing gear WARNING SILENCE button are pressed simultaneously. Each tone lasts 0.5 second and is heard in both cockpits.

WCAs DISPLAYED ON THE HUD AND MFD

MDP generated WCAs are defined as follows:

- a. A warning is a signal which alerts the aircrew to a dangerous condition requiring immediate action.
- b. A caution is a signal which alerts the aircrew to a condition requiring attention, but not necessarily immediate action.
- c. An advisory is a signal that includes a safe or normal condition, or is used to attract attention and impart information or instructions.

When visual warnings and cautions are initiated, a flashing message is displayed in the HUD message window, in the top half (gear down) or bottom half (gear up). Warnings are boxed, and cautions are unboxed.

On the MFD, a warning or caution appears on all display formats, except for the HUD and EED Display Pages, in a location just below the EADI. Warnings are red and boxed, and cautions are yellow and unboxed. All warnings and cautions flash. Whenever a warning or caution is displayed on the HUD, the same message is displayed on both MFD's.

Advisories on the HUD are steady and unboxed, and appear in the bottom half of the HUD, regardless of landing gear status. Advisories are not displayed on the MFD.

T.O. 1T-38C-1

WCA

WCAs are available in all Master Modes.

NOTE

The NO BRK X caution is available only in A/G Master Mode, and is only displayed in the HUD.

WCA TONES

Some WCAs have tones associated with them or are communicated to the aircrew by tones alone. Refer to Figure 1-275. The tones are not audible when audio backup mode is selected on the ACP in either cockpit.

WCA VISUAL AND AURAL TONE PRIORITIES

When more than one WCA is activated simultaneously, the higher priority WCA is displayed, Figure 1-275. When the higher priority WCA is removed, the next higher priority WCA is issued. If a higher priority WCA does not have an tone, and the lower priority one does, the tone of the lower priority WCA is audible.

WCA	CATEGORY	HUD/MFD DISPLAY PRIORITY	TONE PRIORITY	WCA REMOVAL UPON UFCP ACK PRESS
FIRE	Warning	1		Yes
STALL	Warning	2	1	Yes
ALTITUDE	Warning	3	2	Yes
GEAR	Warning	4	3	Removes visual only
CAUTION	Caution	5		Yes
ENGINE	Caution	6		Yes
OVER G (alternating tones)	Caution	7	4	Removes visual only
MAX G (continuous tone)	Caution		5	No
High G (double rate beep)	Caution		6	No
Medium G (single rate beep)	Caution		7	No
AVIONICS	Caution	8		Yes
BINGO	Caution	9		Yes
NO BRK X	Caution	10		No
DESCEND	Caution	11		Yes
EGI Status Messages	Advisory	12		No
Chaff/Flares	Advisory		8	No
Weapons Release	Advisory		9	No
Lamp/audio test	N/a		10	No

Figure 1-275. WCA Visual and Tone Priorities

NOTE

When the TCAS system detects a threat aircraft at TA or RA level, it generates dedicated aural alerts that notify the aircrew of the threat and issue evasive flight commands. The TCAS displays and commands work separately from this priority system. Refer to IDENTIFICATION FRIEND OR FOE (IFF)/TRAFFIC COLLISION AVOIDANCE SYSTEM (TCAS), this section.

WARNINGS

FIRE WARNING

When a fire warning light illuminates, a boxed, flashing FIRE warning is displayed in the HUD message window, and a red, boxed, flashing FIRE warning is displayed in the MFD message window. There is no tone associated with the FIRE warning.

The warning is removed upon pressing the ACK function key, or when both fire lights are off. Pressing ACK only removes the warning from the HUD and MFD, but does not affect the cockpit fire lights. Refer to FIRE WARNING AND DETECTION SYSTEM, this section.

STALL WARNING

When the landing gear is extended and 0.80 AOA is reached or exceeded, a boxed, flashing STALL warning is displayed in the HUD message window, and a red, boxed, flashing STALL warning is displayed in the MFD message window.

A high pitched beeping tone is activated when the STALL warning is displayed.

The warning and tone are removed when the gear is retracted, when the ACK function key is pressed, or when the AOA decreases to less than 0.80.

NOTE

- The visual warning and tone are not activated until the nose gear is down and locked.
- The STALL warning may be activated momentarily during aerobraking.

- In the event of RCP nose gear indication circuitry failure to the MDP; the STALL warning is not available (refer to Warning/Caution/Advisory (WCA) System, this section), gear down symbology on the HUD is not displayed (Refer to F-16 HUD Gear Down Symbols, this section and MIL-STD HUD Gear Down Symbols, this section), and the MDP automatic speed calculation is disabled.

Refer to ANGLE OF ATTACK (AOA) SYSTEM, this section.

ALTITUDE WARNING

When the altitude measured by the barometric altimeter or the radar altimeter is lower than the corresponding minimum altitude set on the UFCP ALT Key Display (i.e., the MSL or RALT altitude warning setting), a boxed, flashing ALTITUDE warning is displayed in the HUD message window, and a red, boxed, flashing ALTITUDE warning is displayed in the MFD message window. For a RALT warning, the altitude warning setting on the F-16 HUD also flashes.

There are four options available for ALTITUDE warning source selection. Aircrew can select BOTH, MSL only, RALT only, or OFF via the UFCP ALT Key Display. The MDP powerup default is BOTH. The ALTITUDE warning settings can be loaded via the DTC or entered manually via the UFCP ALT Key Display.

For both types of warning sources, a medium pitched beeping tone is activated when the ALTITUDE warning is displayed. The tone has a duty cycle of ½ second on and 1 second off.

At altitudes of less than 5,000 feet MSL in A/A and A/G Master Modes, and any altitude in NAV Master Mode, the RALT warning tone consists of three cycles of three beeps per cycle lasting approximately 3.5 seconds. Then the tone is removed for 11.5 seconds. As long as the aircraft altitude is below the MSL set altitude and the warning has not been acknowledged, this cycle repeats every 15 seconds. The visual warning is displayed continuously.

For aircraft altitudes greater than 5,000 feet MSL, in A/A and A/G Master Modes only, the MSL warning tone consists of one cycle of three beeps, and is not

T.O. 1T-38C-1

WCA

repeated. The visual warning remains displayed as long as the aircraft altitude is below the MSL set altitude and the warning has not been acknowledged.

For the RALT warning, the tone is continuous for as long as the radar altitude is below the RALT set altitude and the warning has not been acknowledged.

If the conditions are met simultaneously for both warning sources, the continuous RALT tone is used.

The ALTITUDE warning for each source is armed only when the aircraft reaches the corresponding set altitude for the first time.

Climbing above the minimum set altitude, pressing the ACK function key, or selecting a lower minimum altitude for warning activation via the UFCP ALT Key Display, removes both the warning and tone. If the ALTITUDE warning is removed by ACK press, the visual warning and tone do not return until the aircraft climbs above the set altitude and descends below it again.



If neither warning source is enabled (i.e., UR-1 of the UFCP ALT Key Display is set to OFF), then no ALTITUDE warnings are issued at any time.

NOTE

- When transitioning from NAV Master Mode to A/A or A/G Master Mode above 5,000 feet MSL, the repeating pattern changes to the one-cycle tone and then is not repeated. However, when transitioning from A/A or A/G Master Mode to NAV Master Mode and/or below 5,000 feet MSL, the repeating pattern will not return after the one-cycle tone has already been issued.
- In case of an in-air power cycle of the MDP, an ALTITUDE warning is issued upon MDP recovery if either the current aircraft MSL or AGL altitude is lower than the corresponding DTC-loaded altitude warning setting.

- If the barometric altitude warning and a lower priority tone (e.g., GEAR or g tones) are active simultaneously, the lower priority tone is heard during the 11.5-second silent period of the barometric altitude warning's repeating pattern, or continuously after the one-cycle tone is issued, as applicable.

Refer to UFCP FUNCTION KEYS and DATA TRANSFER SYSTEM (DTS), this section.

GEAR WARNING

When the landing gear warning system is activated, a boxed, flashing GEAR warning is displayed in the HUD message window, and a red, boxed, flashing GEAR warning is displayed in the MFD message window.

A low pitched beeping tone is activated when the GEAR warning is displayed.

The visual warning and tone are removed when the landing gear warning system no longer meets the activation criteria. The tone can be silenced by pressing the landing gear WARNING SILENCE button. Pressing the landing gear WARNING SILENCE button does not remove the visual warning. The ACK function key removes the visual warning, but does not silence the tone.

NOTE

In the event of an electrical relay failure that prevents the rear cockpit nose gear light from illuminating, false GEAR warnings may be issued and gear down symbology on the HUD will not be displayed.

Refer to LANDING GEAR SYSTEM, this section.

CAUTIONS

MASTER CAUTION

Whenever the cockpit MASTER CAUTION light illuminates, a flashing CAUTION is displayed in the HUD message window, and a yellow flashing CAUTION is displayed in the MFD message window.

There is no tone associated with the CAUTION.

The CAUTION is removed when the MASTER CAUTION light is deactivated by either correcting the problem, pressing the MASTER CAUTION light, or pressing the UFCP ACK function key. Pressing the ACK function key does not affect the MASTER CAUTION light or any of the caution lights on the Caution Light Panel.

ENGINE CAUTION

A flashing ENGINE is displayed in the HUD message window, and a yellow flashing ENGINE is displayed in the MFD message window, when any one of the following events occurs in the left or right engine:

- a. RPM exceedance
- b. Oil pressure high or low caution
- c. Oil pressure high or low latch
- d. EGT overtemperature
- e. Loss of engine sensor input

There is no tone associated with the ENGINE caution.

RPM exceedances, oil pressure latches, and EGT overtemperatures are latching events. For these

events, the ENGINE caution is not removed when its cause is eliminated; it must be removed by pressing the ACK function key.

For oil pressure cautions and loss of engine sensor input, the ENGINE caution is removed when its cause is eliminated, or by pressing the ACK function key.

For oil pressure latches, EGT overtemperatures, or loss of engine sensor input, the MALF menu option is displayed in amber at MOSB MB-5 on the PFR, HSD, and MENU Display Pages, and an entry is created on the PFL Display Page. Pressing MALF selects the PFL Display Page for review of the malfunction.

As long as the MALF menu option has not been selected, it remains at MOSB MB-5 to indicate that the aircrew has not selected the PFL Display Page to review the most recent fault, even if the ENGINE caution has been acknowledged. Once the aircrew has selected the MALF option, the option turns green on the MENU Display Page, and is removed from the PFR and HSD, Figure 1-276.

ENGINE EVENT	PFL ISSUED	ENGINE CAUTION REMOVAL UPON ELIMINATION OF CAUSE	ENGINE CAUTION REMOVAL UPON UFCP ACK PRESS
RPM Exceedance	No	Yes	Yes
Oil Pressure Low Caution	No	Yes	Yes
Oil Pressure High Caution	No	Yes	Yes
Oil Pressure Low Latch	Yes	No	Yes
Oil Pressure High Latch	Yes	No	Yes
EGT Overtemperature	Yes	No	Yes
Loss of engine sensor input	Yes	Yes	Yes

Figure 1-276. Engine Caution Events

For more information on these engine events, including the latching events, refer to ELECTRONIC ENGINE DISPLAY (EED), this section.

OVER G CAUTION AND G TONES

The medium g, high g, and max g tones are initiated, in order of increasing acceleration, as the aircraft’s normal acceleration, measured by accelerometers in the EGI, and displayed on the MFD G Meter and HUD current g load, approaches the current g limits. The g tones are issued based on the number of gs remaining before reaching the limit, in order to notify the aircrew before an over g event occurs. The g tones are not accompanied by visual cautions, and cannot be removed by pressing the ACK function key. They are active for as long as the condition exists.

Whenever the normal acceleration exceeds the g limit, a flashing OVER G is displayed in the HUD message

window, and a yellow flashing OVER G is displayed in the MFD message window. The over g tone is activated when the OVER G caution is displayed.

The OVER G caution is not removed from the HUD and MFD when the over g condition no longer exists; it must be removed by pressing the ACK key. The over g tone is audible as long as the condition exists, with a minimum of 3 seconds. As long as it is audible, the tone cannot be removed by pressing the ACK key.

NOTE

G tones pertain to both symmetric and asymmetric gs.

The four g tones and the OVER G visual caution are described in Figure 1-277.

CONDITION	STONE DESCRIPTION	DISPLAY ADVISORY	DURATION
Medium G proximity (1.00-0.50 positive or 0.50-0.25 negative G remain)	Medium pitch single rate beep	---	While condition exists
High G proximity (0.50-0.20 positive or 0.25-0.010 negative G remain)	Medium pitch double rate beep	---	While condition exists
MAX G (0.20-0.00 positive or 0.10-0.00 negative G remain)	Medium pitch continuous tone	---	While condition exists
Over G (> 100 % of G limit)	Alternating low/medium pitch tone	OVER G	Tone - While condition exists, minimum of 3 seconds Visual Caution - Latches until ACK key pressed

Figure 1-277. G Tone Mechanization

For more information on the MFD G Meter and g related displays, refer to MULTIFUNCTIONAL DISPLAY (MFD) and HEAD UP DISPLAY (HUD), this section.

AVIONICS CAUTION

When an avionics system malfunction creates an entry on the PFL Display Page, a flashing AVIONICS caution is displayed in the HUD message window and a yellow flashing AVIONICS caution is displayed in the MFD message window. When the AVIONICS caution is activated, the MALF menu option is displayed in yellow at MOSB MB-5 on the PFR, HSD, and MENU Display Pages.

There is no tone associated with the AVIONICS caution.

The caution is removed when the cause of the malfunction is eliminated, by pressing the ACK function key, or by selecting MALF at MOSB MB-5 on the PFR, HSD, or MENU Display Pages

If the ACK function key is used to remove the caution, the yellow MALF menu option remains at MOSB MB-5, indicating that the aircrew has not selected the PFL Display Page to review the most recent malfunction. Once the aircrew has selected the MALF option, or the cause of the malfunction is

eliminated, the option turns green on the MENU Display Page, and is removed from the PFR and HSD.

A new avionics malfunction does not activate the AVIONICS caution if the malfunction occurs while the PFL Display Page is displayed on either cockpit MFD. A new or recurring malfunction initiates the caution only when the PFL Display Page is not displayed.

BINGO CAUTION

When the total fuel quantity decreases to below the Bingo value set via the UFCP SET Key Display or loaded via the DTC, a flashing BINGO caution is displayed in the HUD message window and a yellow flashing BINGO caution is displayed in the MFD message window.

There is no tone associated with the BINGO caution.

The caution is removed by pressing the ACK function key or by selecting a lower quantity for the Bingo value on the UFCP SET Key Display. If it has not been acknowledged, it is not removed if the fuel quantity again increases above the Bingo value. After removing the caution once, it will not be displayed again if the fuel quantity increases and again

T.O. 1T-38C-1

WCA

decreases below the Bingo value. The BINGO caution can be reenabled by reentering a different Bingo value.

Refer to UFCP FUNCTION KEYS and DATA TRANSFER SYSTEM (DTS), this section.

NO BREAK (BRK) X CAUTION

The NO BRK X caution is displayed only in the HUD message window in A/G Master Mode, whenever valid radar altimeter data is not available and the steerpoint does not have a defined elevation.

There is no tone associated with the NO BRK X caution.

This caution cannot be removed by pressing the ACK function key. It is only removed when valid radar altimeter data becomes available, the elevation of the steerpoint is defined, a new steerpoint with a defined elevation is selected, or upon exit from A/G Master Mode. Refer to T.O. 1T-38C-34-1-1.

DESCEND CAUTION

When the Divert Profile of Emergency Divert Mode is active and the descent conditions are met, a flashing DESCEND is displayed in the HUD message window, and a yellow flashing DESCEND is displayed in the MFD message window.

There is no tone associated with the DESCEND caution.

The DESCEND caution is removed after 10 seconds or when the aircrew acknowledges it using the ACK function key. If the aircraft exits and then reenters the descent phase of the profile, or if Emergency Divert Mode is disabled and then reenabled while the aircraft is still in the descent phase, the DESCEND caution is displayed again. Refer to GPS/INS BASED NAVIGATION, this section.

ADVISORIES

EGI STATUS MESSAGES

EGI Status Messages are displayed only in the HUD message window. These advisories do not flash.

There are no tones associated with the EGI Status Messages.

EGI Status Messages cannot be removed by pressing the ACK key, but are removed or changed automatically when no longer pertinent. These advisories include:

- a. WAIT- EGI coarse alignment in progress, do not move the aircraft.
- b. DEGRADED- EGI fine alignment in progress, not yet full.
- c. FULL- EGI fine alignment is complete.
- d. NO GPS- GPS not available (displayed concurrently with DEGRADED or FULL).
- e. NAV- EGI is in NAV mode (displayed for 10 seconds).
- f. LEVEL- Keep wings level for in-flight alignment.
- g. ATT- EGI is attitude mode.

Refer to EMBEDDED GLOBAL POSITIONING SYSTEM/INERTIAL NAVIGATION SYSTEM (EGI), this section.

CHAFF/FLARE RELEASE TONE

A high pitched beep is activated when all conditions are satisfied for CMD deployment and the CMD switch is pressed. Refer to T.O. 1T-38C-34-1-1.

There are no visual advisories associated with the Chaff/Flare Release Tone.

WEAPON RELEASE TONE

A high pitched tone is activated when all conditions are satisfied for a weapon release and the pickle button or trigger (second detent) is pressed. Refer to T. O. 1T-38C-34-1-1.

There are no visual advisories associated with the Weapon Release Tone.

MALFUNCTION MONITORING

All avionics and engine malfunctions are recorded in the downloaded data and displayed on the MFD MFL Display Page. Some of these malfunctions generate an entry on the PFL Display page.

A yellow MALF label is displayed at MOSB MB-5 on the PFR, HSD, and MENU Display Pages whenever a malfunction generates an entry into the Pilot Fault List (PFL) Display Page, and causes a flashing AVIONICS or ENGINE caution to be issued. The PFL

Display Page is selected by pressing MOSB MB-5 when MALF is displayed (Figure 1-278). The MFL Display Page is selected by pressing MFL (ML-5) on the PFL Display Page. If MALF is not displayed at MOSB MB-5 on the PFR or HSD Display Pages, the PFL Display Page can be accessed via MOSB MB-5 on the MENU Display Page.

The entry on the PFL Display Page contains information to assist the aircrew in understanding the nature of the malfunction. The name of the system and a short statement describing the malfunction are displayed for each failure.

All existing malfunctions are displayed on the PFL Display Page, according to their sequence of appearance, with the latest malfunction on top. If more than

one display is required for the PFL Display Page, a page number is added, and NEXT (MOSB ML-4) and BACK (MOSB ML-3) options are made available to cycle between pages.

If a new malfunction that generates a caution has occurred since the PFL Display Page was last selected, the new entry appears upon entry to the page surrounded by a rectangle. If a new malfunction appears while the PFL Display Page is already selected, it is surrounded by a flashing rectangle.

An entry on the PFL Display Page is removed for a malfunction that no longer exists.

Refer to Section III for a list of PFLs.

1. MENU DISPLAY PAGE



3. MFL DISPLAY PAGE



2. PFL DISPLAY PAGE

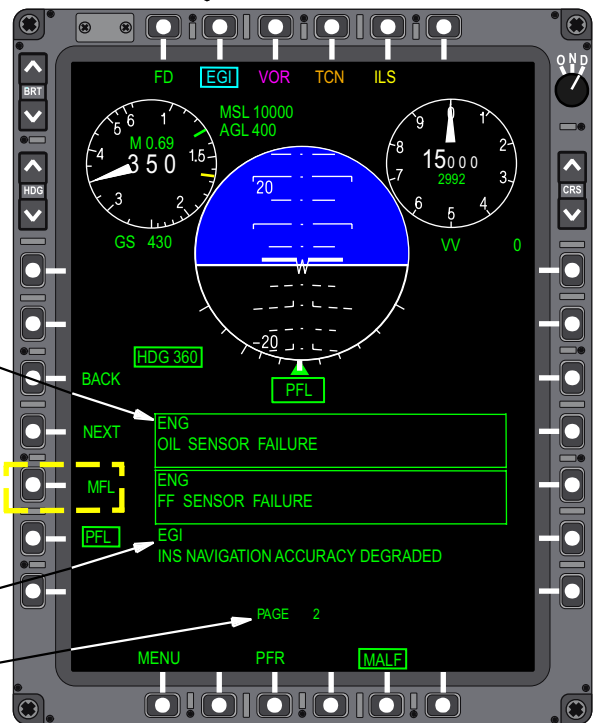

Figure 1-278. MALF Display Page

SYSTEMS MONITORING AND TEST

TEST DISPLAY PAGE

The TEST Display Page on the MFD provides access to systems monitoring and testing options. The functions selectable via the TEST Display Page are designed primarily for maintenance purposes. The TEST Display Page (Figure 1-279) is selected by pressing TEST (ML-1) from the MENU Display Page. The following display pages are accessible via the TEST Display Page:

- a. MFD - ML-3: selects the MFD_TEST Display Page.
- b. DSCIN - ML-4: selects the DESCRETE IN Display Page.
- c. IBIT - MR-3: selects the IBIT Display Page.
- d. TONE - MR-4: selects the AURAL TONE Display Page.
- e. SW_V - MR-5: selects the SOFTWARE-VERSION Display Page.
- f. FLAP - MR-6: selects the FLAP ANGLE Display Page.
- g. MENU - MB-1: selects the MENU Display Page.
- h. PFR - MB-3: selects the PFR Display Page.
- i. TEST - MB-6: selects the TEST Display Page.

Exit from the TEST Display Page is accomplished by selecting MENU (MB-1), PFR (MB-3) or DDS.

MFD TEST Display Page (ML-3)

The MOSBs on the MFD can be tested via the MFD TEST Display Page by selecting ML-3 from the Test Display Page. Exit from the MFD TEST Display Page is accomplished by selecting MENU (MB-1), PFR (MB-3), TEST (MB-6) or DDS.

DSCIN Display Page (ML-4)

The status of discrete inputs to the MDP can be monitored on the DSCIN Display Page. Exit from the DSCIN Display Page is accomplished by selecting MENU (MB-1), PFR (MB-3), TEST (MB-6) or DDS.

IBIT Display Page (MR-3)

The IBIT Display Page is selected by pressing IBIT (MR-3) on the TEST Display Page.

NOTE

- IBIT data is provided to assist in maintenance actions. Aircrews shall not initiate IBIT procedures unless requested by maintenance. False MFLs are created if IBITs are not executed correctly.
- IBITs are only selectable with WOW.

Exit from the IBIT Display Page is accomplished by selecting MENU (MB-1), PFR (MB-3), PFL (MB-4), MFL (MB-5), TEST (MB-6) or DDS.

EGI IBIT (ML-3)

While the EGI IBIT is in progress, it performs a complete GC alignment. A normal IBIT should end with the EGI in FULL alignment. It does not automatically transition to NAV mode at the end of the IBIT. The EGI must be in GC-Align mode before starting EGI IBIT.

TCAS IBIT (ML-4)

In order for the TCAS status to display RDY, the EGI must be in NAV mode, and the ADC must be on and reporting a valid barometric altitude. Once the IBIT is in progress, test intruders are displayed on the MFD, and test exclusion zones are displayed on the MFD and HUD. When the test is complete, the TCAS system announces the result of the test, TCAS SYSTEM TEST OK or TCAS SYSTEM TEST FAIL, and the test intruders and zones are removed from the displays.

RALT IBIT (ML-5)

While the RALT IBIT is in progress, the Radar Altimeter outputs an altitude of 1000 feet on the MFD and HUD.

1. MENU DISPLAY PAGE

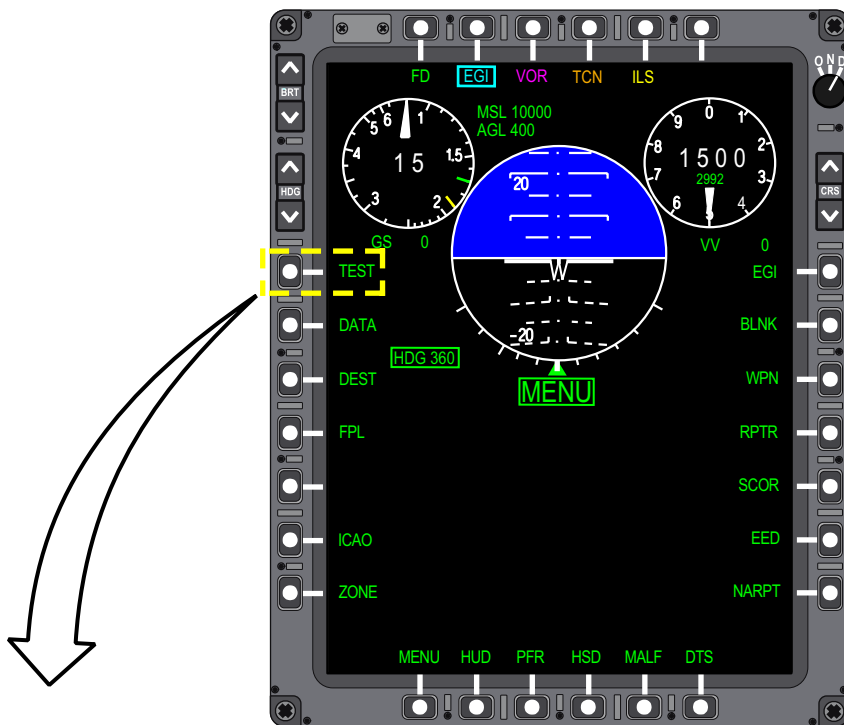

2. TEST DISPLAY PAGE



3. IBIT DISPLAY PAGE



Figure 1-279. MFD Test and IBIT Displays

UFCPF IBIT (ML-6)

While an IBIT of the FCP UFCP is in progress, the display on the UFCP may be momentarily blanked. When the IBIT is complete, it will return to normal.

UFCPR IBIT (ML-7)

While an IBIT of the RCP UFCP is in progress, the display on the UFCP may be momentarily blanked. When the IBIT is complete, it will return to normal.

TACAN IBIT (MR-2)

While the TACAN IBIT is in progress, the TACAN displays 180° and 0 NM on the PFR Display Page and HUD.

DTS IBIT (MR-3)

In order for the DTS status to display RDY, a DTC must be inserted properly inside the DTS.

ADC IBIT (MR-4)

While the ADC IBIT is in progress, the MFD and HUD display 420 knots and 10,000 feet.

YSAS IBIT (MR-5)

In order for the YSAS status to display RDY, the EGI must be in GC-Align mode.

After the YSAS IBIT is selected, an ENGAGE SAS message is displayed in white on the IBIT Display Page. When the message appears, the SAS should be engaged within 6 seconds by setting the DAMPER switch to YAW. The DAMPER switch is automatically disengaged during the test.

MDFD IBIT (MR-6)

While an IBIT of the FCP MFD is in progress, the FCP MFD pages through several black, white, and

gray test patterns, and ends on an internal test display that provides information about the MFD, including firmware version and serial number. Pressing OK at MT-2 on this internal test display ends the IBIT and returns to the normal MDP generated display. If OK is not pressed, the MFD will time out after 20 seconds and return to the normal MDP-generated display.

MFDA IBIT (MR-7)

While an IBIT of the RCP MFD is in progress, the RCP MFD pages through several black, white, and gray test patterns, and ends on an internal test display that provides information about the MFD, including firmware version and serial number. Pressing OK at MT-2 on this internal test display ends the IBIT and returns to the normal MDP-generated display. If OK is not pressed, the MFD will time out after 20 seconds and return to the normal MDP-generated display.

OTHER BUILT-IN TEST (BIT) MODES

In addition to the available IBITs, avionics units may automatically perform a Powerup and a Periodic Built-In Test (PBIT).

Powerup BIT consists of tests performed automatically during initialization of the unit. Powerup BIT is completed in the first few seconds after power application and verifies critical functionality prior to the processing of data.

Periodic BIT consists of tests that are performed automatically in the background during normal operation. These tests help ensure the correct operation of the unit and the validity of data in a non-intrusive manner.

T.O. 1T-38C-1
SYSTEM TEST

The following table shows the BIT modes available for each avionics system.

EQUIPMENT	TYPE OF BIT		
	Power Up	Periodic	Initiated
ADC	Yes	Yes	Yes
AIU	No	Yes	No
DTS	Yes	Yes	Yes
EED	Yes	Yes	Yes
EGI	Yes	Yes	Yes
HUD	Yes	Yes	No
MDP	Yes	Yes	No
MFD	Yes	Yes	Yes
Mode S Transponder	No	Yes	Yes
TCAS	Yes	Yes	Yes
TACAN/DME	Yes	No	Yes
TRU	No	Yes	No
UFCP	Yes	Yes	Yes
UHF	No	Yes	No
VHF	No	Yes	No
VOR/ILS	No	Yes	No

AURAL TONE Display Page (MR-4)

Pressing TONE (MR-4) selects the AURAL TONE Display Page. When an option button is pressed, as shown in the following table, the appropriate tone is generated for 3 seconds. Only one tone can be generated at a time.

OSB	TONE
ML-3	STALL
ML-4	GEAR
ML-5	MIN/ALT
ML-6	OVER G
ML-7	MAX G
MR-3	HIGH G
MR-4	MED G
MR-5	CMD
MR-6	RELEASE

Refer to WARNING/CAUTION/ADVISORY (WCA) SYSTEM, this section.

SOFTWARE VERSION Display Page (MR-)

Pressing SW_V (MR-5) selects the SOFTWARE VERSION Display Page. The version number, date, and time of the MDP software load is indicated on this display page.

FLAP ANGLE Display Page (MR-6)

Pressing FLAP (MR-6) selects the FLAP ANGLE Display Page. The position of the flaps is displayed as XXX.XX° preceded by a (+) or (-). If the data is not valid, DATA NOT VALID is displayed. If the ADC has failed or is off, ADC OFF is displayed.

EED TEST AND IBIT

In normal mode, the EED enters IBIT after the TEST (T) pushbutton is pressed for greater than 2 seconds and released within 15 seconds. An EED IBIT is completed in less than 10 seconds. If the EXIT pushbutton is not pressed while on the test page, the EED times out after 20 seconds and returns to normal mode. The EED operates in slave mode during IBIT, allowing the other EED to operate as master and continue to display engine and fuel data, Figure 1-280.

NOTE

With WOW, pressing the T button for longer than 15 seconds selects the calibration page, Figure 1-280. The calibration page is intended for maintenance functions only. It should not be selected by the pilot. The calibration page is exited when any of the following occur:

- Pressing the EED (C) Pushbutton (EXIT).
- Selecting WEIGHT OFF WHEELS on the WOW Switch in the RCP.
- At takeoff (weight-off-wheels).
- When the other cockpit EED (both FCP and RCP EEDs must be ON) switches to the master mode.
- The respective EED is turned OFF.

EED NORMAL DISPLAY (WOW)

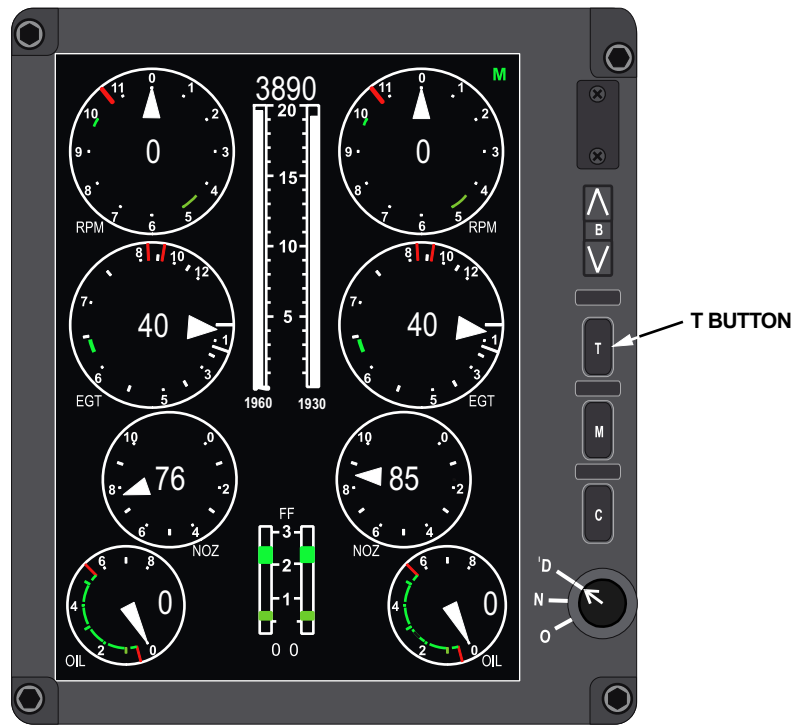

EED CALIBRATION DISPLAY

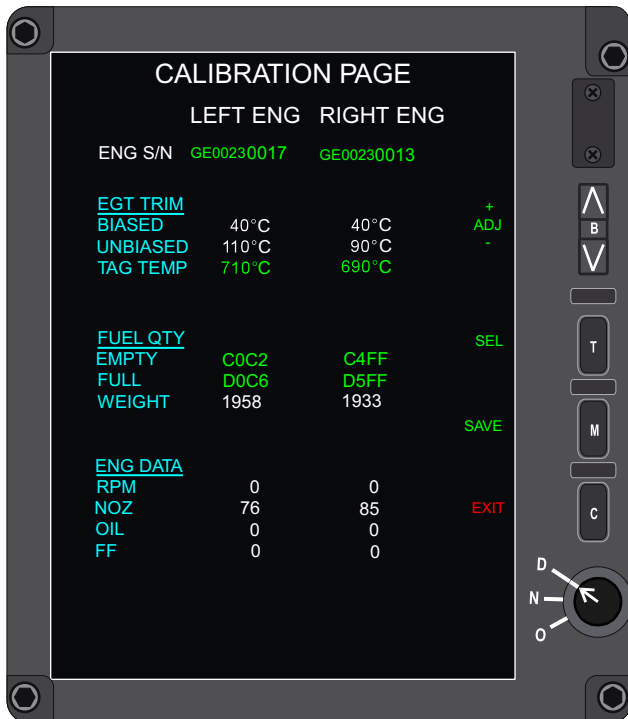

EED IBIT DISPLAY



Figure 1-280. EED IBIT and Calibration Display Pages

MISCELLANEOUS EQUIPMENT

ADDITIONAL EQUIPMENT

Additional items provided include:

- a. Instrument hood
- b. Rear view mirrors
- c. Map data case
- d. Weapon System Support Pod (WSSP). Some aircraft are equipped to carry a WSSP which mounts under the center section of the fuselage. The nose section of the pod is attached to a tray which slides out for loading and, when stowed, is secured in place by a metal over-center latch type strap on each side. Each latch strap is covered by a streamlined fairing which is secured by a wing nut Dzus fastener. The pod is approximately 84 inches long, 24 inches wide, 16 inches deep and weighs 110 pounds empty. Normal load capacity is approximately 140 pounds.

NOTE

With a WSSP installed, the radar altimeter is unusable. Selecting POD configuration on the MFD WPN display ensures proper g calculations and turns RALT off.

e. Elastic tiedown cords. The optional tiedown cords secure the RCP seat pack/survival kit in the seat bucket during solo flights for pilot/passenger pickup or delivery missions. They are to be attached in a crisscross fashion by attaching the rear cord hooks to the safety belt attachment clevis pins near the back of the seat bucket on one side and the other hook attached under the opposite forward corner of the seat bucket.

SERVICING DIAGRAM

The aircraft servicing diagram is shown in Figure 1-281.

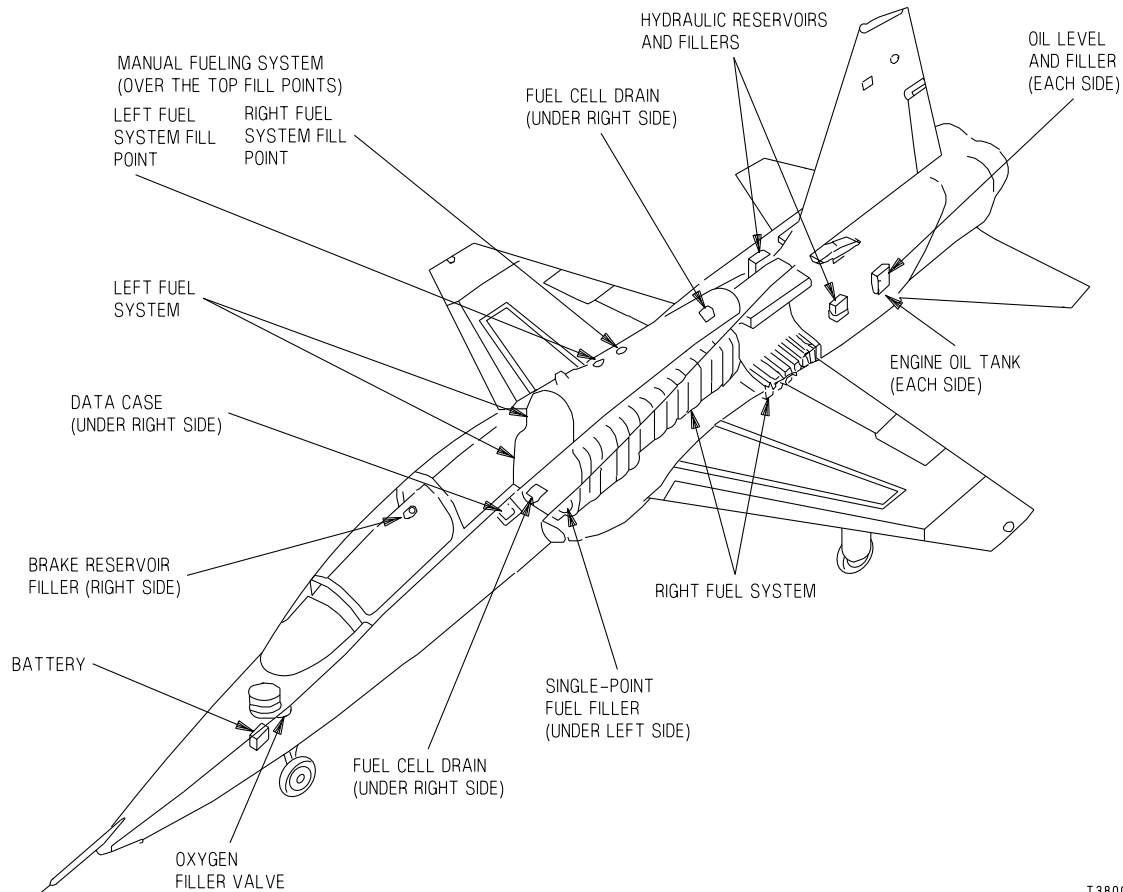

T38002-11-1-020

FLUID SPECIFICATIONS

**FUEL QUANTITY DATA
SINGLE-POINT REFUELING**

	USAF	NATO SYM-BOL	FULLY SERVICED			USABLE	
			GALLONS	POUNDS JP-8	GALLONS	POUNDS JP-8	
FUEL	MIL-T-5624 GRADE JP-8 ALTERNATE: 1 EMERGENCY: 1	F-40, F-34					
ENGINE OIL	MIL-L-7808 ALTERNATE: NONE	O-148	LEFT SYSTEM	293	1963	286	1916
HYDRAULIC FLUID	MIL-H 5606	H-515	RIGHT SYSTEM	305	2043	297	1990
BRAKE FLUID	MIL-H 83282	H-537	TOTAL	598	4006	583	3906
LIQUID OXYGEN	MIL-O-27210	NONE					
NOTE 1 Refer to Strange Field Procedures in section II for electrical field units, air starting units, alternate and emergency fuel operating information.			NOTE 2 JP-8 fuel weight (6.7 ppg) based on fuel temperature of 60 degrees F. 3 Subtract 40 pounds (6 gallons) from total usable fuel if manually refueled. Usable fuel quantity tolerances are +/- 25 pounds for each (L/R) system. Total usable fuel can differ up to 100 pounds from FCP to RCP EED as master.				

Figure 1-281. Servicing Diagram

SECTION II

NORMAL PROCEDURES

TABLE OF CONTENTS

	Page
Preflight Check.....	2-1
Interior Inspection, Engine Start and Before Taxiing - Battery Start.....	2-10
Interior Inspection, Engine Start and Before Taxiing - External Electrical Power Start	2-19
Taxiing	2-25
Before Takeoff.....	2-25
Takeoff.....	2-26
After Takeoff	2-27
Climb	2-27
Level-Off and Cruise.....	2-27
Descent.....	2-27
Before Landing	2-29
Landing.....	2-29
After Landing.....	2-32
Engine Shutdown	2-33
Instrument Flight Procedures	2-34
Instrument Approaches	2-35
Circling Approaches	2-40
Fuel Balancing (Crossfeed)	2-40
UHF Control via UHF Backup Control Panel	2-40
NAV Backup Control Panel	2-41
Manual Data Transfer	2-41
Strange Field Procedures	2-42

PREFLIGHT CHECK

BEFORE EXTERIOR INSPECTION (WITH/WITHOUT EXTERNAL POWER)

Items identified with an asterisk (*) shall be checked in both cockpits, as applicable.

1. Check AFTO Form 781 for aircraft status and proper servicing. Seat and canopy safety pins - INSTALLED
- * 2. If safety pins other than seat and canopy pins are installed, do not remove until the status of the ejection system has been checked with maintenance personnel.
- * 3. (AFTER T.O. 1T-38C-546) SAFE/ARMED handle - SAFE
- * 4. FLAPS lever - MATCH FLAP POSITION
5. MASTER switch - SAFE
6. CMD switch - OFF
7. PITOT HEAT - OFF
8. BATTERY switch - ON (apply external power if available)

NOTE

If the aircraft will not accept external AC power and the ground power unit checks good, cycling the battery switch OFF then ON may actuate necessary relays to allow the aircraft to accept external AC power.

9. EED - N/D (as required)

NOTE

If EED fails to display properly, recycle power to affected EED.

BEFORE T.O. 1T-38C-546

10. (DUAL) Rear seat pack/survival kit elastic tiedown cords - REMOVE AND STORE AS REQUIRED

T.O. 1T-38C-1

- *11. Seat pack tiedown straps - SECURITY AND CONDITION (if applicable)
- *12. Oxygen hose retention strap - CHECK SECURITY AND ADJUST
- *13. Seat attach bolts - CHECK

WARNING

The two attach bolts must be aligned with the arrows and reference line (or shoulder) of catapult head. See ejection seat illustration, Figure 1-33.

- *14. Drogue chute cover - CHECK
Check the left cover fits closely and conforms to the contour of the drogue chute container. The forward edge of the cover should fit inside or below the edge of container. The right cover is fixed in place.

WARNING

If the drogue chute cover is forced above the edges of the container, the chute is improperly installed and shall be replaced. If the drogue chute cover is not flush with the drogue chute container and if the canopy is lost or jettisoned in flight, wind blast effect could separate the drogue chute cover from the container and cause inadvertent drogue chute deployment. Chute deployment could cause an immediate out-of-control condition.

- 15. AAP switches - OFF, NORM (ON, NORM if external power available)

CAUTION

Over travel or vibration of the MDP, TCAS, and EGI power switches on the AAP may result in an OFF condition and cause an equipment reboot. This can occur without activation of the respective switch.

- *16. Landing gear lever - LG DN
Physically check full down.
- *17. Standby attitude indicator - CAGED AND LOCKED
- 18. UFCP/HUD
 - a. NT/AUT/DAY switch - AS REQUIRED

- b. Power switch - OFF (ON, if external power available)
- 19. MFD - OFF (N/D as required if external power available)
- 20. FLDR power switch - ON (if installed)
- 21. DTC - INSTALL

An electrical static discharge between the pilot and the DTS when inserting the data cartridge may cause a NO CASSETTE or DTS OFF display on the MFD DTS display page. If this occurs, try removing and reinserting the cartridge first. If NO CASSETTE still appears, the aircraft power must be cycled to return operability.

CAUTION

Use care to install DTC right side up. Correct position is arrow side up, with arrow facing forward, toward nose of aircraft. If DTC does not lock into position easily, remove, examine, reposition correctly (if required) and reinstall if not damaged. Forcing an incorrectly positioned (upside down or backwards) DTC into a DTD causes a NO CASSETTE advisory to appear and can damage the DTD. An incorrectly installed DTC can jam in the DTD.

- 22. Fuel and oxygen quantity - CHECK
Hold OXY/FUEL check switch in TEST until fuel quantity indicator reaches maximum load fuel reading. Verify FUEL LOW light ON until left and right fuel quantity exceeds 250 lbs.
- 23. EED - OFF (unless external power available)
- 24. BATTERY switch - OFF (unless external power available)
- 25. VTR - LOAD

CAUTION

Use care to install VTR tape correctly. Do not force the VTR cover closed; remove the tape, confirm proper alignment, and reinsert the tape.

AFTER T.O. 1T-38C-546

- 10. (RCP) ISS mode selector - AS DESIRED
- *11. ADU mode selector - AS DESIRED

- *12. Top latch engagement - CHECK
Top latches should be correctly engaged with the guide rail windows.
- *13. Emergency oxygen gauge - CHECK FULL
- *14. Emergency oxygen hose - CHECK
Hose should be correctly attached to the ejection seat and to the quick disconnect.
- *15. Lap and SSK straps - MOVE AWAY FROM SEAT CUSHION
- *16. Leg restraints - CHECK
Confirm taper plugs are engaged in the related line locks.
- *17. Leg garters - CHECK
Confirm the garters are correctly attached to the leg restraint lines.
- 18. AAP switches - OFF, NORM (ON, NORM if external power available)



Over travel or vibration of the MDP, TCAS, and EGI power switches on the AAP may result in an OFF condition and cause an equipment reboot. This can occur without activation of the respective switch.

- *19. Landing gear lever - LG DN
Physically check full down.
- *20. Standby attitude indicator - CAGED AND LOCKED
- 21. UFCP/HUD
 - a. NT/AUT/DAY switch - AS REQUIRED
 - b. Power switch - OFF (ON, if external power available)
- 22. MFD - OFF (N/D as required if external power available)
- 23. FLDR power switch - ON (if installed)
- 24. DTC - INSTALL

An electrical static discharge between the pilot and the DTS when inserting the data cartridge may cause a NO CASSETTE or DTS OFF display on the MFD DTS display page. If this occurs, try removing and reinserting the cartridge first. If NO CASSETTE still appears, the aircraft power must be cycled to return operability.



Use care to install DTC right side up. Correct position is arrow side up, with arrow facing forward, toward nose of aircraft. If DTC does not lock into position easily, remove, examine, reposition correctly (if required) and reinstall if not damaged. Forcing an incorrectly positioned (upside down or backwards) DTC into a DTD causes a NO CASSETTE advisory to appear and can damage the DTD. An incorrectly installed DTC can jam in the DTD.

- 25. Fuel and oxygen quantity - CHECK
Hold OXY/FUEL check switch in TEST until fuel quantity indicator reaches maximum load fuel reading.
- 26. EED - OFF (unless external power available)
- 27. BATTERY switch - OFF (unless external power available)
- 28. VTR - LOAD



Use care to install VTR tape correctly. Do not force the VTR cover closed; remove the tape, confirm proper alignment, and reinsert the tape.

Rear Cockpit (Solo Flights)

- 1. Seat and canopy safety pins - INSTALLED
- 2. (AFTER T.O. 1T-38C-546) SAFE/ARMED handle - SAFE
- 3. (AFTER T.O. 1T-38C-546) ISS mode selector - SOLO
- 4. Seat attach bolts - CHECK

T.O. 1T-38C-1

5. Survival kit/seat pack - AS REQUIRED

WARNING

Seat safety belt and shoulder harness do not provide adequate restraint for survival kit/seat packed during zero or negative-g maneuvers.

NOTE

The survival kit/seat pack shall be removed for solo flights unless required for pilot/passenger pickup missions. For aircrew/passenger pickup flights where transportation of a parachute is required, secure the parachute as follows: set parachute in seat facing forward, leave parachute spacer kit (PSK) (if applicable) attached to parachute harness D-rings. If possible, place survival vest (if used) inside seat pack; if not possible, place survival vest inside parachute harness. Fasten parachute leg and chest straps.

6. Safety belt, shoulder harness, crew/survival kit retention strap, oxygen hose, and man-seat separator straps - SECURE

Unlock inertial reel, wrap shoulder harness around parachute riser (if applicable) and through survival vest (if applicable). Fasten shoulder harness and crew/survival kit retention strap to lap belt with silver key (attached to aircraft oxygen supply hose). Lock inertial reel. Cinch the lap belt, shoulder harness, and crew/survival kit retention strap tight. Tie ends of excess lap belt webbing and excess shoulder harness straps together.

WARNING

If these items are not secured, they may become entangled with the control stick.

7. (BEFORE T.O. 1T-38C-546) Drogue chute cover - CHECK

Check left cover fits closely and conforms to the contour of the drogue chute container. The forward edge of the cover should fit

inside or below edge of container. The right cover is fixed in place.

WARNING

If the drogue chute cover is forced above the edges of the container, the chute is improperly installed and shall be replaced. If the drogue chute cover is not flush with the drogue chute container and if the canopy is lost or jettisoned in flight, wind blast effect could separate the drogue chute cover from the container and cause inadvertent drogue chute deployment. Chute deployment could cause an immediate out-of-control condition.

8. WOW switch - NORM
9. Stowage box cover - CLOSED
10. Standby attitude indicator - UNCAGED

CAUTION

- Avoid snap releasing the pull to cage/pitch trim knob after uncaging the standby ADI to prevent damage to the indicator.
- For solo flight, the RCP standby ADI should be uncaged. There is a risk of damage during flight in the caged and locked position.

11. TAKE COMMAND switch - NORM
12. ACP MIC switch - COLD
13. MFD - OFF
14. EED - N/D (as required)
15. Oxygen - ON/NORMAL/100 %
16. Lights - OFF
17. Map case - CLOSED
18. VTR - LOAD

CAUTION

Use care to install VTR tape correctly. Do not force the VTR cover closed; remove the tape, confirm proper alignment, and reinsert the tape.

19. Loose equipment - STOW
20. Circuit breakers - CHECK

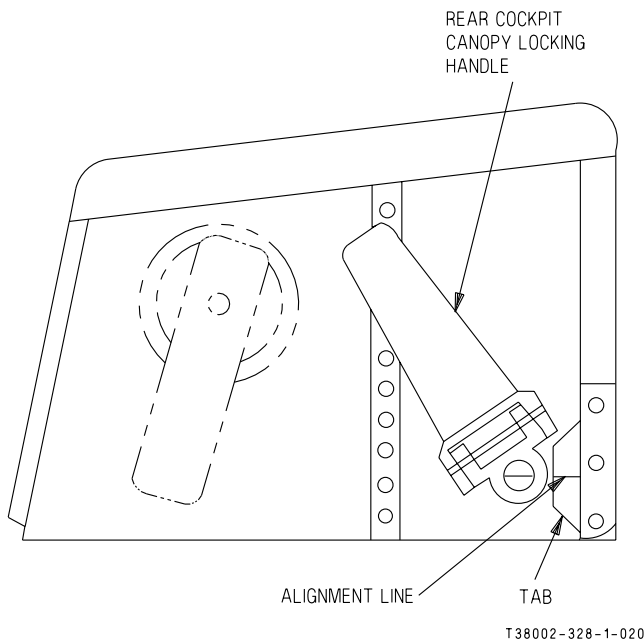

Figure 2-1. Rear Cockpit Canopy Locking Handle Alignment

- 21. Instrument hood - REMOVE AND SECURE
- 22. Canopy - CLOSED AND LOCKED
Ensure horizontal alignment of handle and indicator tab, Figure 2-1.



- The pilot shall personally ensure the rear canopy is closed and locked. To check for a locked condition, the pilot shall push up on the canopy and visually check the markings on the rear canopy locking handle bolt head and nearby tab. Any indication of these marks other than aligned may imply the canopy is not fully closed and locked.

- In the event of a canopy malfunction (difficulty in closing, opening, binding of the canopy or canopy handle during transit, or if the canopy unlocked light remains illuminated with canopy fully closed), do not move the aircraft or attempt further movement of the canopy without having the system checked by qualified maintenance personnel, unless a greater emergency exists as determined by the pilot in command. Efforts to close the canopy or vibrations set up by aircraft movement could result in canopy separation.
- While stowing the outside handle, do not apply clockwise pressure after the canopy is locked.

EXTERIOR INSPECTION

During the exterior inspection, Figure 2-2, the aircraft should be checked for general condition, wheels chocked, access doors, panels, and filler caps secured, and ground wires removed. Check for hydraulic fluid, oil, and fuel leaks. Check to ensure all screws and fasteners forward of the engine intakes are properly installed, or those missing are appropriately annotated in the aircraft forms. Check tires for allowable wear. Additionally, the following specific items will be checked:



SEE S-3

Left Forward Section

1. Inlet duct - CLEAR, CONDITION
2. Cabin drains - CHECK
Ensure all drains are in the released (out) position and are not depressed.
3. Cabin pressurization static port - CLEAR
4. Wheel well - CONDITION
Ensure striker plate is in the raised position. If not, ensure the gear reset lever (FCP left rudder pedal) is in the reset (up) position. This resets all gear switches, but does not raise the striker plate.
5. Nose gear assembly - CONDITION
6. Nose gear safety pin - REMOVE
7. Strut extension - CHECK (5 3/4 to 6 1/8 inches between attach bolt centers of strut upper and lower torque arms)
8. Tire - CONDITION (ensure no cords visible)
9. Total air temperature probe - CHECK
10. Pitot tube and static ports - CLEAR

T.O. 1T-38C-1

Right Forward Section

1. AOA vane - PIN REMOVED, CONDITION



Excessive force applied to the AOA stops may result in damage to the AOA synchro transmitter.

2. Cabin pressurization static port - CLEAR
3. Brake reservoir - CHECK LEVEL
4. Inlet duct - CLEAR, CONDITION
5. Stick well and cabin drains - CHECK
Ensure all drains are in the released (out) position and are not depressed.
6. WSSP (if installed) - SECURE
Check pylon to aircraft attach bolts and pod nose section for security.

Right Center Section

1. Speed brake well - CONDITION
2. Wheel well/main landing gear assembly - CONDITION
3. Main landing gear safety pin - REMOVE
4. Strut extension - CHECK (4 to 4 3/4 inches between attach bolt centers of strut upper and lower torque arms)
5. Wheel, Brake, and Tire - CONDITION
(Ensure no red cords are visible; ensure brake stack moves freely; ensure adjuster nuts are above or flush with respective cylinder rims)
6. Wing - CONDITION

DURING THE EXTERIOR INSPECTION, THE AIRCRAFT SHOULD BE CHECKED FOR GENERAL CONDITION, WHEELS CHOCKED, ACCESS DOORS, ANTENNAS, PANELS, AND FILLER CAPS SECURED, GROUND WIRES REMOVED. CHECK FOR HYDRAULIC OIL AND FUEL LEAKS. CHECK ALL SCREWS/FASTENERS FORWARD OF THE ENGINE INTAKES ARE PROPERLY INSTALLED OR THOSE MISSING ARE APPROPRIATELY ANNOTATED IN THE AFTO 781. BRAKES SHOULD BE CHECKED FOR EXCESSIVE WEAR IF ADJUSTMENT NUT IS LESS THAN FLUSH WITH CYLINDER RIM. ADDITIONALLY, THE FOLLOWING SPECIFIC ITEMS WILL BE CHECKED:

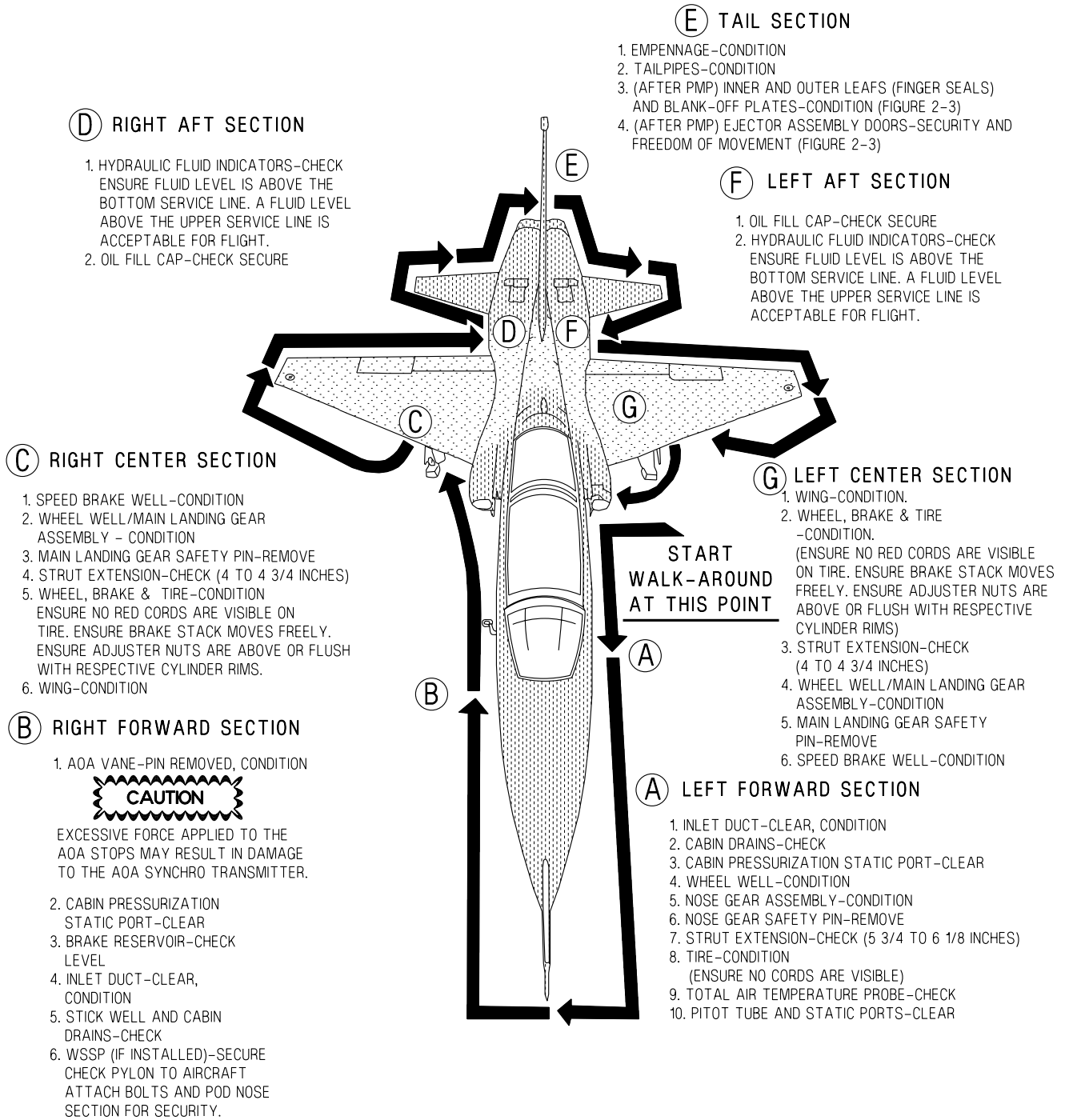

(D) RIGHT AFT SECTION

1. HYDRAULIC FLUID INDICATORS—CHECK ENSURE FLUID LEVEL IS ABOVE THE BOTTOM SERVICE LINE. A FLUID LEVEL ABOVE THE UPPER SERVICE LINE IS ACCEPTABLE FOR FLIGHT.
2. OIL FILL CAP—CHECK SECURE

(E) TAIL SECTION

1. EMPENNAGE—CONDITION
2. TAILPIPES—CONDITION
3. (AFTER PMP) INNER AND OUTER LEAFS (FINGER SEALS) AND BLANK-OFF PLATES—CONDITION (FIGURE 2-3)
4. (AFTER PMP) EJECTOR ASSEMBLY DOORS—SECURITY AND FREEDOM OF MOVEMENT (FIGURE 2-3)

(F) LEFT AFT SECTION

1. OIL FILL CAP—CHECK SECURE
2. HYDRAULIC FLUID INDICATORS—CHECK ENSURE FLUID LEVEL IS ABOVE THE BOTTOM SERVICE LINE. A FLUID LEVEL ABOVE THE UPPER SERVICE LINE IS ACCEPTABLE FOR FLIGHT.

(C) RIGHT CENTER SECTION

1. SPEED BRAKE WELL—CONDITION
2. WHEEL WELL/MAIN LANDING GEAR ASSEMBLY — CONDITION
3. MAIN LANDING GEAR SAFETY PIN—REMOVE
4. STRUT EXTENSION—CHECK (4 TO 4 3/4 INCHES)
5. WHEEL, BRAKE & TIRE—CONDITION ENSURE NO RED CORDS ARE VISIBLE ON TIRE. ENSURE BRAKE STACK MOVES FREELY. ENSURE ADJUSTER NUTS ARE ABOVE OR FLUSH WITH RESPECTIVE CYLINDER RIMS.
6. WING—CONDITION

(G) LEFT CENTER SECTION

1. WING—CONDITION.
2. WHEEL, BRAKE & TIRE —CONDITION. (ENSURE NO RED CORDS ARE VISIBLE ON TIRE. ENSURE BRAKE STACK MOVES FREELY. ENSURE ADJUSTER NUTS ARE ABOVE OR FLUSH WITH RESPECTIVE CYLINDER RIMS)
3. STRUT EXTENSION—CHECK (4 TO 4 3/4 INCHES)
4. WHEEL WELL/MAIN LANDING GEAR ASSEMBLY—CONDITION
5. MAIN LANDING GEAR SAFETY PIN—REMOVE
6. SPEED BRAKE WELL—CONDITION

START WALK-AROUND AT THIS POINT

(B) RIGHT FORWARD SECTION

1. AOA VANE—PIN REMOVED, CONDITION

CAUTION

EXCESSIVE FORCE APPLIED TO THE AOA STOPS MAY RESULT IN DAMAGE TO THE AOA SYNCHRO TRANSMITTER.

2. CABIN PRESSURIZATION STATIC PORT—CLEAR
3. BRAKE RESERVOIR—CHECK LEVEL
4. INLET DUCT—CLEAR, CONDITION
5. STICK WELL AND CABIN DRAINS—CHECK
6. WSSP (IF INSTALLED)—SECURE CHECK PYLON TO AIRCRAFT ATTACH BOLTS AND POD NOSE SECTION FOR SECURITY.

(A) LEFT FORWARD SECTION

1. INLET DUCT—CLEAR, CONDITION
2. CABIN DRAINS—CHECK
3. CABIN PRESSURIZATION STATIC PORT—CLEAR
4. WHEEL WELL—CONDITION
5. NOSE GEAR ASSEMBLY—CONDITION
6. NOSE GEAR SAFETY PIN—REMOVE
7. STRUT EXTENSION—CHECK (5 3/4 TO 6 1/8 INCHES)
8. TIRE—CONDITION (ENSURE NO CORDS ARE VISIBLE)
9. TOTAL AIR TEMPERATURE PROBE—CHECK
10. PITOT TUBE AND STATIC PORTS—CLEAR

Figure 2-2. Exterior Inspection

T.O. 1T-38C-1

Right Aft Section

1. Hydraulic fluid indicators - CHECK
Ensure fluid level is above the bottom service line. A fluid level above the upper line is acceptable for flight.
2. Oil fill cap - CHECK SECURE

Tail Section

1. Empennage - CONDITION
2. Tailpipes - CONDITION
3. (AFTER PMP) Inner and outer leafs (finger seals) and blank-off plates - CONDITION (Figure 2-3)
4. (AFTER PMP) Ejector assembly doors - SECURITY AND FREEDOM OF MOVEMENT (Figure 2-3)

Left Aft Section

1. Oil fill cap - CHECK SECURE

2. Hydraulic fluid indicators - CHECK
Ensure fluid level is above the bottom service line. A fluid level above the upper line is acceptable for flight.

Left Center Section

1. Wing - CONDITION
2. Wheel, Brake, and Tire - CONDITION
(Ensure no red cords visible; ensure brake stack moves freely; ensure adjuster nuts are above or flush with respective cylinder rims)
3. Strut extension - CHECK (4 to 4 3/4 inches between attach bolt centers of strut upper and lower torque arms)
4. Wheel well/main landing gear assembly - CONDITION
5. Main landing gear safety pin - REMOVE
6. Speed brake well - CONDITION

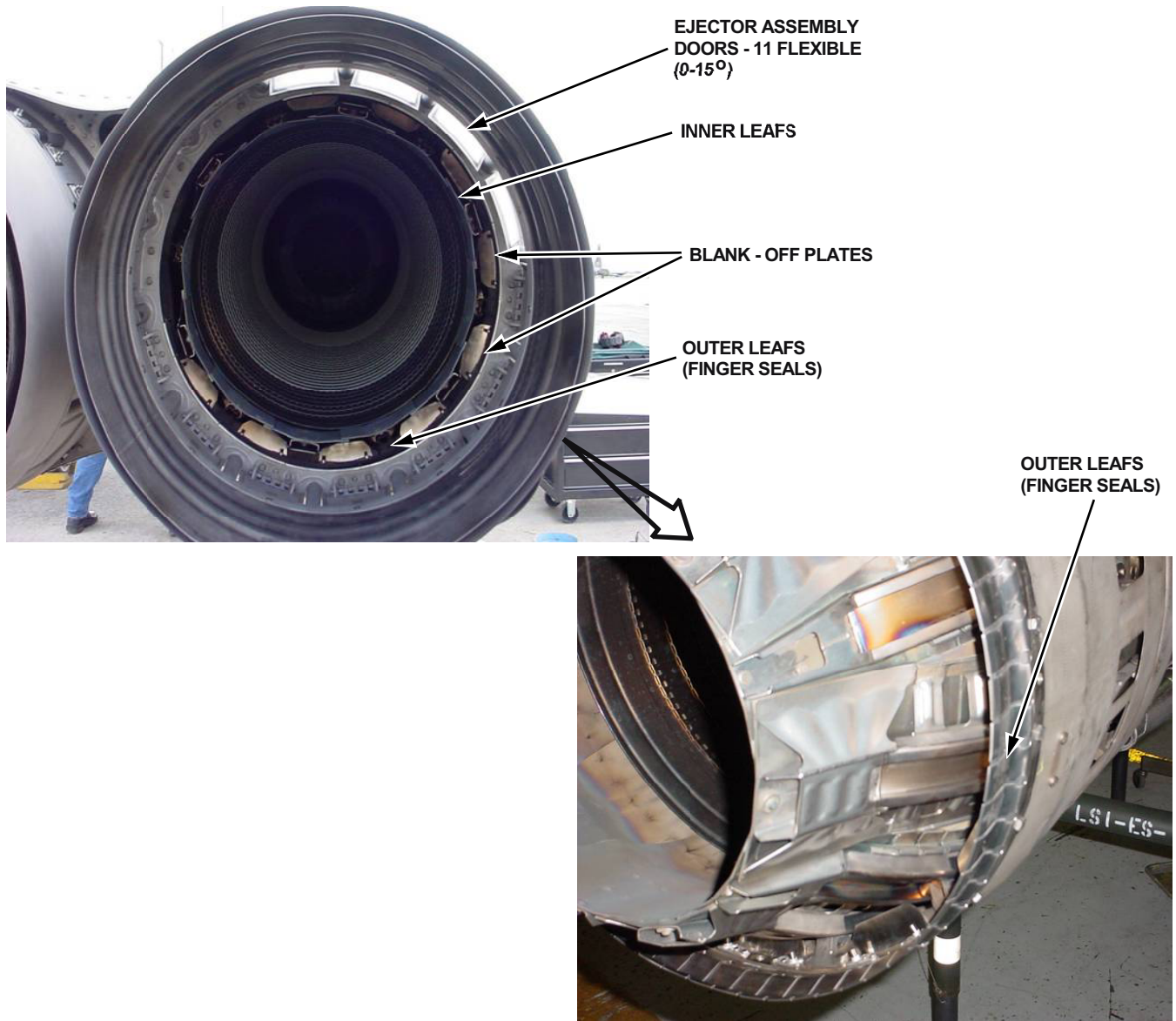

Figure 2-3. Tail Section (AFTER PMP)

T38002-333-1-020

T.O. 1T-38C-1

INTERIOR INSPECTION, ENGINE START AND BEFORE TAXIING - BATTERY START

WARNING

INTERIOR INSPECTION

NOTE

Aircrew shall direct the cabin air vents so that moisture is not blown on to the right console in either the FCP or RCP.

On dual flights, all items marked with an asterisk (*) shall also be checked in the rear cockpit.

1. BATTERY switch - ON
- * 2. ACP switches - AS REQUIRED
3. Crew retractable steps - STOWED
If steps are used, the pilot shall make sure they are stowed to prevent flight with the steps extended.
- * 4. Survival kit (if applicable) - ATTACH AND ADJUST

WARNING

- Survival kit must be connected to the parachute harness prior to fastening lap belt. Failure to properly tighten these straps could result in injury or seatman-chute entanglement during ejection sequence. Loose straps can result in the kit moving forward and up and out of the seat bucket during zero or negative-g maneuvers and restrict or prohibit control stick movement aft in both cockpits.
- Ensure survival kit straps are routed under the safety belt to prevent interference and possible man seat entanglement during ejection sequence.

BEFORE T.O. 1T-38C-546

- * 5. Safety belt, shoulder harness, crew/survival kit retention strap (if applicable), parachute arming lanyard anchor (silver key), oxygen connectors, hose retention strap, anti-G suit hose, and helmet chin strap - FASTEN AND ADJUST

- Failure to attach personal equipment correctly may prevent separation from seat after ejection. See Figures 1-35, 1-36, and 1-37.
 - Make sure that hose retention strap is adjusted to preclude hose separation from oxygen disconnect on parachute harness.
 - Do not route the anti-G suit hose under the safety belt or in any manner which would interfere with disconnecting the hose if required.
 - The oxygen hose from the mask to the disconnect should be routed under the right shoulder harness strap before connecting to the disconnect. This helps keep the shoulder harness clear of the connector and prevents the harness from being snagged between the connector and its mounting plate during seat separation.
 - The seat pack can rise up and move forward during zero or negative-g maneuvers even though the seat safety belt and shoulder harness are tightly adjusted.
- * 6. Ejection seat hand grips - PUSH (to ensure fully down)

AFTER T.O. 1T-38C-546

- * 5. Backrest - ADJUST
See Figure 2-4.
 - a. Backrest retaining knob - PULL
Then turn the knob 90° to hold the knob away from the forward or aft slot in the seat bucket.
 - b. Backpad - REMOVE
Pull off the top of the backrest to show the cloth handle.
 - c. Backrest - LIFT
Lift the backrest using the cloth handle until the backrest retaining knob is out of the forward or aft slot.

NOTE

- The backrest has two positions, FORWARD and AFT.
 - When the backrest is in the forward position, a yellow indication panel is visible on the top left hand side of the backrest.
- d. Bottom of backrest - POSITION
- (1) Move the guide pin and location plunger fully forward or aft in the related location brackets.
 - (2) Align the location dowels with the FORWARD or AFT location holes on the seat bucket.

NOTE

When the backrest is correctly in the FORWARD position, all the location devices are also in the FORWARD position. When the backrest is correctly in the AFT position, all the location devices are also in the AFT position.

- e. Top of backrest - POSITION
Align the location holes with the FORWARD or AFT location pins on the seat bucket.
- f. Backrest - LOWER
Until devices are fully engaged.
- g. Backrest retaining knob - TURN 90°
Let the spring pressure move the knob into the FORWARD or AFT slot in the backrest. Make sure that the knob is fully into the FORWARD or AFT slot to lock the backrest in position.
- h. Backpad - ATTACH TO BACKREST
- * 6. Safety belt, shoulder harness, seat survival kit quick release connectors, oxygen connectors, hose retention strap, anti-G suit hose, leg garters, and helmet chin strap - FASTEN AND ADJUST
- a. Seat height - ADJUST



Do not operate the seat adjust switch for more than 1 minute in any 8 minute period or the seat actuator could be damaged.

- b. Leg garters - FASTEN
See Figure 2-5.
Make sure leg restraint lines are not twisted or crossed.
 - (1) Lower leg garter - POSITION
On the lowest part of the calf immediately above top of boot with the D-ring aft and the adjustment buckle and quick-release connector on the inner side of thigh.
 - (2) Upper leg garter - POSITION
Around thigh, near knee. Strap with D-ring below knee with the adjustment buckle and quick-release connector on inner side of thigh.
- c. Attach leg garters to legs with quick release connectors and adjustment buckles. Fasten loose ends with hook and loop fasteners. Also, put the fabric loop on each upper leg garter above the loose end of each upper leg garter.
- d. SSK quick release connectors - ATTACH
- e. Lap straps - ATTACH
Position straps above SSK attachment straps, above thighs, and in the center.
- f. Inertia reel lever - FORWARD
- g. Lift webs - REMOVE FROM HOOK FASTENERS

A rectangular icon with a double border containing the word "WARNING" in bold, uppercase letters.

Pull the two lift webs above the shoulders simultaneously or the webbing can wind incorrectly into the inertia reel device. An incorrectly wound inertia reel device can cause injury or death.

- h. Lift web harness release fittings - CONNECT TO HARNESS
- i. Shoulder harness - CHECK
Confirm that with the lever forward the shoulder harness is unlocked. Then move lever aft and confirm the shoulder harness is locked.

ALL AIRCRAFT

- * 7. Oxygen system - CHECK
 - a. Pressure - The pressure gage should read 50-120 PSI (Figure 5-2) and should agree with the pressure gage in the other cockpit.

T.O. 1T-38C-1

- b. Regulator - Check regulator supply lever ON. Hook up mask and perform a pressure check. Place the emergency flow lever in EMERGENCY, take a deep breath and hold it. If mask leaks, readjust mask and check pressure. The oxygen should stop flowing if the mask is properly fitted. If the oxygen continues to flow, the regulator, hose, or valve is not holding pressure, and the cause of the leak should be corrected. Return the emergency lever to NORMAL. If you cannot exhale, the valve has malfunctioned and the discrepancy should be corrected.

WARNING

It is possible for the supply lever to stop in an intermediate position between OFF and ON. Care should be taken to push the supply lever full ON and visually check the flow indicator blinker for proper functioning.

- c. Indicator - With the SUPPLY lever ON, switch the diluter lever from NORMAL OXYGEN to 100 % OXYGEN position and check blinker for proper operation.

NOTE

There should be a distinct difference in the sound of the flow when 100 % oxygen is selected. If not, suspect oxygen diluter valve failure.

- d. Connections - Check connection secure at the seat. Check regulator hose for kinks, cuts, or cover fraying. Check that male part of the disconnect is not warped and rubber gasket is in place. A 12 to 20-pound pull should be required to separate the two parts. Check mask hose properly installed to connector.
- e. Emergency - Check emergency oxygen cylinder properly connected and a minimum pressure of 1800 PSI.

NOTE

The pressure gage must be checked during parachute preflight.

8. UHF Backup Control Panel - ON, SET

9. NAV Backup Control Panel - ON, SET
10. TACAN Backup Control Panel - ON, SET
*11. Circuit breakers - CHECK
*12. WOW switch - NORM (RCP)
13. Gear door switch - NORMAL
14. AUX FLAP switch - NORMAL
15. AAP switches - OFF/NORMAL

CAUTION

Over travel or vibration of the MDP, TCAS, and EGI power switches on the AAP may result in an OFF condition and cause an equipment reboot. This can occur without activation of the respective switch.

16. Rudder trim knob - CENTERED
*17. Throttles - OFF
18. Speed brake switch - EXTEND (AFT)
19. Fuel shutoff switches - NORMAL
20. Comm antenna switch - AUTO
21. Landing gear alternate release handle - IN
22. Landing/taxi light switch - OFF
*23. Landing gear lever - DOWN
*24. Standby airspeed indicator - CHECK
*25. Standby attitude indicator - UNCAGE AND ADJUST

CAUTION

Avoid snap releasing the pull-to-cage/pitch trim knob after uncaging the standby ADI to prevent damage to the indicator.

- *26. Standby altimeter - SET AND CHECK

CAUTION

Do not rotate the standby altimeter barometric set knob at a rapid rate or exert force to overcome momentary binding. If binding occurs, the required setting may be established by rotating the barometric set knob a full turn in the opposite direction and then approaching the desired setting carefully.

- *27. Standby vertical velocity indicator - CHECK
*28. MFD - OFF

- *29. EED - N/D (as required)
Check EED not FAILED and no engine indicator title latched red.

NOTE

- If the EED fails to display properly, recycle power to the affected EED.
- If battery voltage is less than 22 VDC, the EED display powers up at maximum day mode brightness regardless of switch position, and reverts to selected brightness level when first generator comes on line.

- 30. Magnetic compass - CHECK
- 31. Cabin altimeter - CHECK
- 32. Fuel boost pump switches - ON
- 33. Crossfeed switch - OFF
- 34. OXY/FUEL check switch - GAUGE TEST
Verify FUEL LOW light ON until left and right fuel quantity exceeds 250 lbs.

- 35. Generator switches - ON
- 36. Cabin pressure switch - CABIN PRESS
- 37. Cabin temperature switch - AUTO
- 38. PITOT HEAT - OFF
- 39. Engine anti-ice switch - OFF
- *40. Warning test switch - TEST
Check warning, caution, advisory lights illuminated.

NOTE

All four fire warning light bulbs in both cockpits must illuminate during TEST. Failure of any bulb to illuminate may indicate an inoperative fire detector.

- *41. Interior lights - AS REQUIRED
- 42. FORMATION lights - AS REQUIRED
- 43. Rotating BEACON - ON
- 44. POSITION lights - AS REQUIRED
- *45. Cockpit loose items - SECURED

(AFTER T.O. 1T-38C-546)

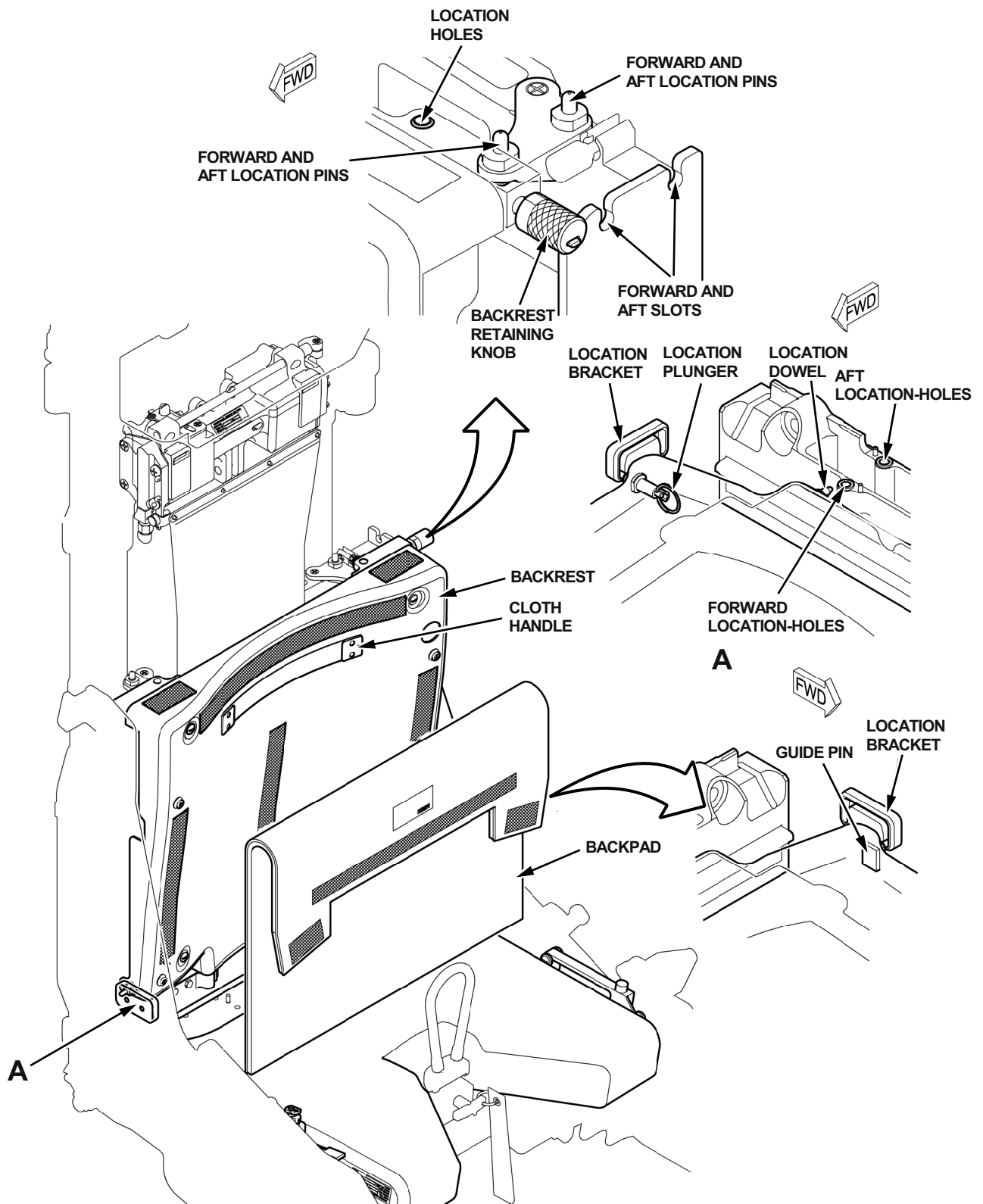

Figure 2-4. Backrest Adjustment

T38002-348-1-021

(AFTER T.O. 1T-38C-546)

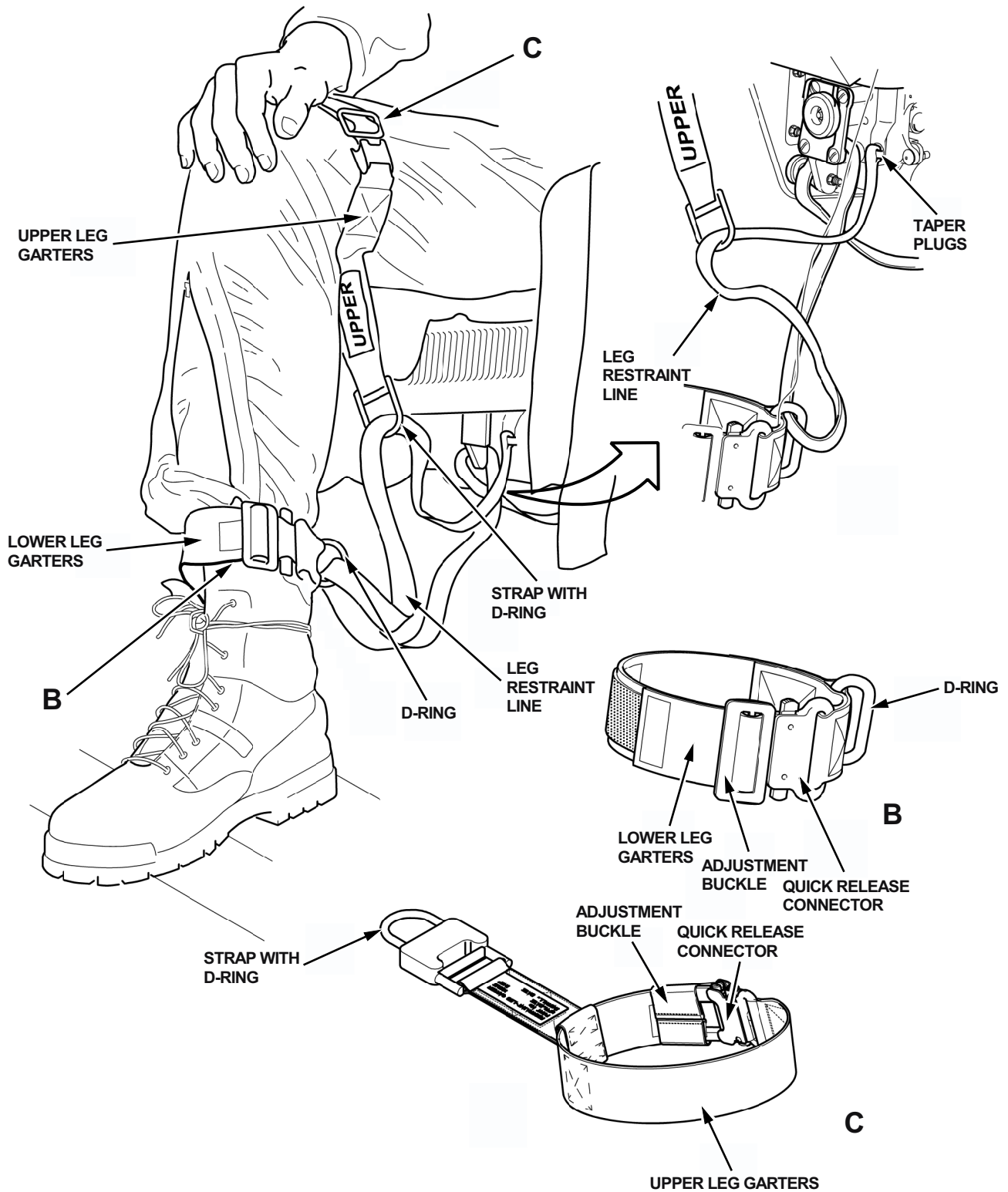

Figure 2-5. Leg Restraint Line and Garters

T38002-365-1-021

T.O. 1T-38C-1

STARTING ENGINES

NOTE

- Start the right engine first when external electrical power is not available.
- Before engine start, with external or battery power applied, the EED fuel flow indicator(s) should read no higher than 60 PPH. A higher indication may be an indication of EED failure or a fuel transmitter failure.

Right Engine

1. Danger areas - CLEAR
See Figure 2-6.
2. External air - APPLY
3. Engine start button - PRESS (12% RPM MIN)
4. EED - CHECK EGT NOT FAILED, CHECK OIL PRESSURE NOT FAILED
5. Throttle - ADVANCE TO IDLE



- Do not advance throttles above idle RPM without a positive (>0) indication of oil pressure.
 - If ignition does not occur before fuel flow reaches 360 LB/HR, abort start, reset throttle to OFF.
 - If EGT does not begin to rise within 12 seconds after the first indication of fuel flow, abort the start.
 - After any aborted start after fuel flow is indicated, maintain airflow to permit fuel and vapors to be purged from engine. Wait at least 2 minutes to permit fuel to drain before attempting another start.
 - If engine ignition is normal, but RPM does not reach generator cut-in speed before termination of the start cycle, push the engine start button to make sure aircraft electrical power is available to monitor the start.
6. Engine indicators - CHECK

7. Hydraulic pressure - CHECK
8. Caution light panel - CHECK

Left Engine

1. Left engine - START (same as right engine)
2. Throttle gate - ENGAGED (if installed)
- * 3. Anti-G suit - TEST
4. AAP switches - ON/NORM
- * 5. MFD - N/D
6. UFCP/HUD - ON
7. External air - REMOVE
- * 8. Circuit Breakers - CHECK

BEFORE TAXIING

1. Pitot tube/TAT probe/AOA vane heat - CHECK

NOTE

The following cockpit indications can occur when pitot heat operations on the ground exceed 30 seconds:

- a. YSAS can disengage and not reengage unless sufficient cooling airflow is generated (25 knots) or pitot is turned off and it cools sufficiently.
 - b. Due to vibration of the AOA vane transmitter heating element, an ADC PFL can be generated and all three AOA indexer lights may illuminate.
 - c. TAS is not available for display.
2. DTC Data - LOAD/VERIFY (as required)



Verify POD configuration is selected on MFD WPN display page if WSSP is loaded.

3. Pitch trim - CHECK FORE/AFT
Ensure stick repositions with activation of trim button in both directions.
4. Aileron trim - CHECK NEUTRAL
Ensure aileron is faired with wing surface.

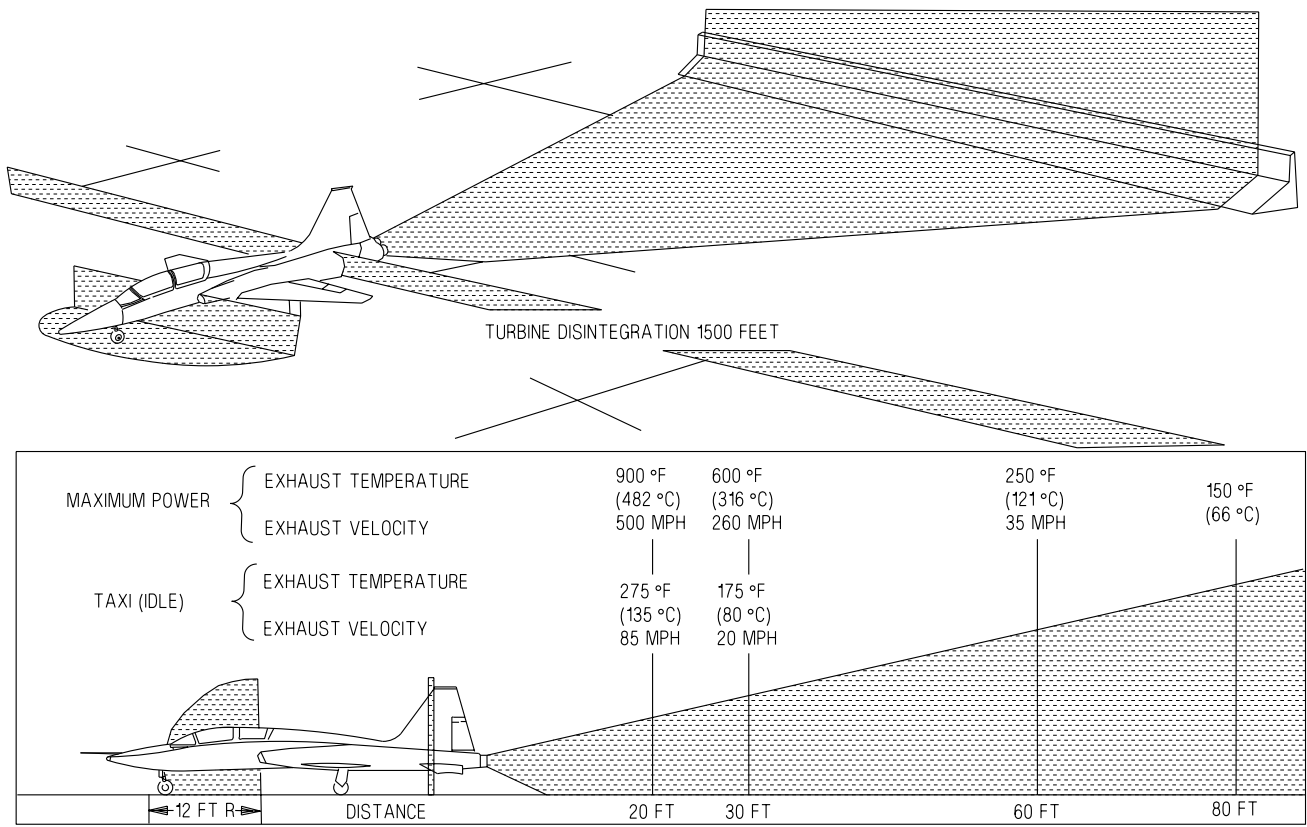

T38002-13-1-020

Figure 2-6. Danger Areas

SEE SS-1

5. Flight controls - CHECK

With normal movement, hydraulic pressure should not drop below 1500 PSI. Check visually for proper displacement and freedom of movement.

WARNING

The artificial feel assembly makes abnormal flight control conditions difficult to detect by feel only; therefore, aircrew must visually confirm proper movement of the actual flight control surfaces.

6. Speed brake - CLOSED

7. FLAPS - CHECK

Flaps down to 60%, full down, then retract to 60%. The FLAP position indicator should be checked at 60±5% when flaps are lowered or retracted. Visually note the trailing edge of the slab moves down continuously as the

flaps are lowered. Also note the trailing edge of the slab moves up as the flaps are raised.

WARNING

Do not attempt flight if proper operation of the flap-slab interconnect system has not been verified. The leading edge of the horizontal tail must be aligned with the upper index mark on the fuselage at the 60% flap setting.

NOTE

ADC ADVISORY PFL and ADC MFL(s) 0-7 and/or 0-8 can be encountered when flaps are extended or retracted. The PFL advisory and associated MFLs indicate the flap synchro transmitter is out of range.

8. UFCP - SET AS REQUIRED

T.O. 1T-38C-1

9. Cabin temperature/canopy defog - SET

WARNING

For night or anticipated weather operation with conditions of high humidity and narrow temperature-dew point spread, the canopies should be closed and the cabin temperature increased to the 100° AUTO position to preheat all flight instruments and canopy surfaces. Return temperature control to a comfortable in flight setting after completion of the TAXIING checklist.

10. OXY/FUEL check switch - GAUGE TEST
Verify oxygen quantity decreases and oxygen low level caution light illuminates in both cockpits at approximately 1 liter remaining indication.
- *11. Warning test/warning silence/tones - TEST
With warning test switch in the TEST position, ensure landing gear tone is heard and all four fire lights are illuminated in both cockpits. While holding warning test switch in the TEST position, press the warning silence button near the landing gear handle momentarily, the landing gear warning tone should cease and the full aural tone sequence should be heard.
- *12. Survival kit (AUTO/MANUAL) - AS REQUIRED (if installed)
13. INS - CHECK
A full alignment is indicated by FULL on the MFD EGI display page after STAT.
14. EGI - NAV

NOTE

- Operation of the EGI in NAV Mode without FULL ALIGNMENT degrades the performance of the EGI. This can result in erroneous operation.
- After commanding EGI into NAV via the UFCP, window 3R blinks ALN for approximately 3 seconds prior to displaying NAV. Pressing UR-3 on the UFCP EGI Key display places EGI back into alignment mode, continuing from when it was placed in NAV. Attempting a continued alignment following a SH

alignment begins a GC alignment process from the beginning.

15. Yaw damper switch - YAW
16. Crossover relay - CHECK
Turn the R GEN switch off and check for proper crossover indications (no PFLs, HUD remains on, etc.). Turn the R GEN switch on.

NOTE

Following generator crossovers, HUD may blank momentarily, return in a full DIM, or full bright condition, or fail to return completely. The MDP may generate PFLs/MFLs or in extreme cases reboot after generator crossovers. If HUD intensity is affected (DIM/BRIGHT/no return) and/or UFCP HUD brightness control does not respond, cycle the front cockpit UFCP power switch. Check and set HUD brightness and resume normal operations.

- *17. Seat height - ADJUST

WARNING

Ensure all equipment is stowed and clear of the handgrips to prevent inadvertent handgrip movement during seat adjustment. Whenever practical during ground operations, adjust the seat with the seat safety pin installed.

- *18. Ejection seat and canopy safety pins - REMOVE AND STOW AS REQUIRED
- *19. (AFTER T.O. 1T-38C-546) SAFE/ARMED handle - ARMED
- *20. Brakes - CHECK PEDAL PRESSURE
21. Chocks - REMOVE

INTERIOR INSPECTION, ENGINE START AND BEFORE TAXIING - EXTERNAL ELECTRICAL POWER START

WARNING

INTERIOR INSPECTION

NOTE

Aircrew shall direct the cabin air vents so that moisture is not blown on to the right console in either the FCP or RCP.

On dual flights, all items marked with an asterisk (*) shall also be checked in the rear cockpit.

1. BATTERY switch - ON (if not already on)
2. External electrical power - APPLY (if not already connected)

NOTE

If the aircraft will not accept external AC power and the ground power unit checks good, cycling the battery switch OFF then ON may actuate necessary relays to allow the aircraft to accept external AC power.

- * 3. ACP switches - AS REQUIRED
- 4. Crew retractable steps - STOWED
If the steps are used, the pilot shall make sure they are stowed to prevent flight with the steps extended.
- * 5. Survival kit (if applicable) - ATTACH AND ADJUST

- Survival kit must be connected to the parachute harness prior to fastening lap belt. Failure to properly tighten these straps could result in injury or seatman-chute entanglement during ejection sequence. Loose straps can result in the kit moving forward and up out of the seat bucket during zero or negative-G maneuvers and restrict or prohibit control stick movement aft in both cockpits.
- Ensure survival kit straps are routed under the safety belt to prevent interference and possible man-seat entanglement during ejection sequence.

BEFORE T.O. 1T-38C-546

- * 6. Safety belt, shoulder harness, crew/survival kit retention strap (if applicable), parachute arming lanyard anchor (silver key), oxygen connectors, anti-G suit hose, helmet chin strap - FASTEN AND ADJUST

WARNING

- Failure to attach personal equipment correctly may prevent separation from seat after ejection. See Figures 1-35, 1-36, and 1-37.
 - Make sure that hose retention strap is adjusted to preclude hose separation from oxygen disconnect on parachute harness.
 - Do not route the anti-G suit hose under the safety belt or in any manner which would interfere with disconnecting the hose if required.
 - The oxygen hose from the mask to the disconnect should be routed under the right shoulder harness strap before connecting to the disconnect. This helps keep the shoulder harness clear of the connector and prevents the harness from being snagged between the connector and its mounting plate during seat separation.
 - The seat pack can rise up and move forward during zero or negative-G maneuvers even though the seat safety belt and shoulder harness are tightly adjusted.
- * 7. Ejection seat handgrips - PUSH (to ensure fully down)

AFTER T.O. 1T-38C-546

- * 6. Backrest - ADJUST
See Figure 2-4.
- a. Backrest retaining knob - PULL
Then turn the knob 90° to hold the knob away from the forward or aft slot in the seat bucket.
 - b. Backpad - REMOVE
Pull off the top of the backrest to show the cloth handle.
 - c. Backrest - LIFT
Lift the backrest using the cloth handle until the backrest retaining knob is out of the forward or aft slot.

NOTE

- The backrest has two positions, FORWARD and AFT.
 - When the backrest is in the forward position, a yellow indication panel is visible on the top left hand side of the backrest.
- d. Bottom of backrest - POSITION
- (1) Move the guide pin and location plunger fully forward or aft in the related location brackets.
 - (2) Align the location dowels with the FORWARD or AFT location holes on the seat bucket.

NOTE

When the backrest is correctly in the FORWARD position, all the location devices are also in the FORWARD position. When the backrest is correctly in the AFT position, all the location devices are also in the AFT position.

- e. Top of backrest - POSITION
Align the location holes with the FORWARD or AFT location pins on the seat bucket.
 - f. Backrest - LOWER
Until devices are fully engaged.
 - g. Backrest retaining-knob - TURN 90°
Let the spring pressure move the knob into the FORWARD or AFT slot in the backrest. Make sure that the knob is fully into the FORWARD or AFT slot to lock the backrest in position.
 - h. Backpad - ATTACH TO BACKREST
- * 7. Safety belt, shoulder harness, seat survival kit quick release connectors, oxygen connectors, hose retention strap, anti-G suit hose, leg garters, and helmet chin strap - FASTEN AND ADJUST
- a. Seat height - ADJUST

CAUTION

Do not operate the seat raising actuator for more than 1 minute in any 8 minute period or damage will result.

- b. Leg garters - FASTEN
See Figure 2-5.
Make sure leg restraint lines are not twisted or crossed.
 - (1) Lower leg garter - POSITION
On the lowest part of the calf immediately above top of boot with the D-ring aft and the adjustment buckle and quick-release connector on the inner side of thigh.
 - (2) Upper leg garter - POSITION
Around thigh, near knee. Strap with D-ring below knee with the adjustment buckle and quick-release connector on inner side of thigh.
- c. Attach leg garters to legs with quick release connectors and adjustment buckles. Fasten loose ends with hook and loop fasteners. Also, put the fabric loop on each upper leg garter above the loose end of each upper leg garter.
- d. SSK quick-release connectors - ATTACH
- e. Lap straps - ATTACH
Position straps above SSK attachment straps, above thighs, and in the center.
- f. Inertia reel lever - FORWARD
- g. Lift webs - REMOVE FROM HOOK FASTENERS



Pull the two lift webs above the shoulders simultaneously or the webbing can wind incorrectly into the inertia reel device. An incorrectly wound inertia reel device can cause injury or death.

- h. Lift web harness release fittings - CONNECT TO HARNESS
- i. Shoulder harness - CHECK
Confirm that with the lever forward the shoulder harness is unlocked. Then move lever aft and confirm the shoulder harness is locked.

ALL AIRCRAFT

- * 8. Oxygen system - CHECK
 - a. Pressure - The pressure gage should read 50-120 PSI (figure 5-2) and should agree with the pressure gage in the other cockpit.
 - b. Regulator - Check regulator supply lever ON. Hook up mask and perform a pressure check. Place the emergency flow lever in

EMERGENCY, take a deep breath and hold it. If mask leaks, readjust mask and check pressure. The oxygen should stop flowing if the mask is properly fitted. If the oxygen continues to flow, the regulator, hose, or valve is not holding pressure, and the cause of the leak should be corrected. Return the emergency lever to NORMAL. If you cannot exhale, the valve has malfunctioned and the discrepancy should be corrected.



It is possible for the supply lever to stop in an intermediate position between OFF and ON. Care should be taken to push the supply lever full ON and visually check the flow indicator blinker for proper functioning.

- c. Indicator - With the SUPPLY lever ON, switch the diluter lever from NORMAL OXYGEN to 100 % OXYGEN position and check blinker for proper operation.

NOTE

There should be a distinct difference in the sound of the flow when 100 % oxygen is selected. If not, suspect oxygen diluter valve failure.

- d. Connections - Check connection secure at the seat. Check regulator hose for kinks, cuts, or cover fraying. Check that male part of the disconnect is not warped and rubber gasket is in place. A 12 to 20-pound pull should be required to separate the two parts. Check mask hose properly installed to connector.
- e. Emergency - Check emergency oxygen cylinder properly connected and a minimum pressure of 1800 PSI.

NOTE

The pressure gage must be checked during parachute preflight.

- 9. UHF Backup Control Panel - ON, SET
- 10. NAV Backup Control Panel - ON, SET
- 11. TACAN Backup Control Panel - ON, SET

T.O. 1T-38C-1

- *12. Circuit breakers - CHECK
- *13. WOW switch - NORM (RCP)
- 14. Gear door switch - NORMAL
- 15. AUX flap switch - NORMAL
- 16. AAP switches - ON/NORM



Over travel or vibration of the MDP, TCAS, and EGI power switches on the AAP may result in an OFF condition and cause an equipment reboot. This can occur without activation of the respective switch.

- 17. Rudder trim knob - CENTERED
- *18. Throttles - OFF
- 19. Speedbrake switch - EXTEND (AFT)
- 20. Fuel shutoff switches - NORMAL
- 21. Comm antenna switch - AUTO
- 22. Landing gear alternate release handle - IN
- 23. Landing/taxi light switch - OFF
- *24. Landing gear lever - DOWN
- *25. Standby airspeed indicator - CHECK
- *26. Standby attitude indicator - UNCAGE AND ADJUST



- Avoid snap releasing the pull-to-cage/pitch trim knob after uncaging the standby ADI to prevent damage to the indicator.
- For solo flight, the RCP standby ADI should be uncaged. There is a risk of damage during flight in the caged and locked position.

- *27. Standby altimeter - SET AND CHECK



Do not rotate the standby altimeter barometric set knob at a rapid rate or exert force to overcome momentary binding. If binding occurs, the required setting may be established by rotating the barometric set knob a full turn in the opposite direction and then approaching the desired setting carefully.

- *28. Standby vertical velocity indicator - CHECK
- 29. UFCP/HUD - ON
- *30. MFD - N/D (as required)
- *31. EED - N/D (as required)
Check EED not FAILED and no engine indicator title latched red.

NOTE

If either the EED or MFD Fails to display properly, recycle power to the affected unit.

- 32. Magnetic compass - CHECK
- 33. Cabin altimeter - CHECK
- 34. Fuel boost pump switches - ON
- 35. Crossfeed switch - OFF
- 36. OXY/FUEL check switch - GAUGE TEST
- 37. Generator switches - ON
- 38. Cabin pressure switch - CABIN PRESS
- 39. Cabin temperature switch - AUTO
- 40. PITOT HEAT - OFF
- 41. Engine anti-ice switch - OFF
- *42. Warning test/warning silence/ tones - TEST
With warning test switch in the TEST position, ensure landing gear tone is heard and all four fire lights are illuminated in both cockpits. While holding warning test switch in the TEST position, press the warning silence button near the landing gear handle momentarily, the landing gear warning tone should cease and the full aural tone sequence should be heard.
- *43. Interior lights - AS REQUIRED
- 44. FORMATION lights - AS REQUIRED
- 45. Rotating BEACON - ON
- 46. POSITION lights - AS REQUIRED
- 47. DTC Data - LOAD/VERIFY (as required)



Verify POD configuration is selected on MFD WPN display page if WSSP is loaded.

- 48. UFCP - SET AS REQUIRED
- *49. Cockpit loose items - SECURE

STARTING ENGINES

NOTE

- If left engine is started first, make sure diverter valve is repositioned to number 1 position following right engine start.
- Before engine start, with external or battery power applied, the EED fuel flow indicator(s) should read no higher than 60 PPH. A higher indication may be an indication of EED failure or a fuel transmitter failure.

Right Engine

1. Danger areas - CLEAR
2. External air - APPLY
3. Engine start button - PRESS (12 % RPM MIN)
4. EED - CHECK EGT NOT FAILED, CHECK OIL PRESSURE >0
5. Throttle - ADVANCE TO IDLE



SEE S-2

- Do not advance throttle to idle without a positive (>0) indication of oil pressure.

- If ignition does not occur before fuel flow reaches 360 LB/HR, abort start, reset throttle to OFF.

SEE SS-1

- If EGT does not begin to rise within 12 seconds after the first indication of fuel flow, abort the start.

- After any aborted start after fuel flow is indicated, maintain airflow to permit fuel and vapors to be purged from engine. Wait at least 2 minutes to permit fuel to drain before attempting another start.

- If engine ignition is normal, but RPM does not reach generator cut-in speed before termination of the start cycle, push the engine start button to make sure aircraft electrical power is available to monitor the start.

6. Engine instruments - CHECK

7. Hydraulic pressure - CHECK
8. Caution light panel - CHECK

Left Engine

1. Left engine - START (same as right engine)
2. Throttle gate - ENGAGED (if installed)
- * 3. Anti-G suit - TEST
4. External power and air - REMOVE
- * 5. Circuit breakers - CHECK

BEFORE TAXIING

1. Pitot tube/TAT probe/AOA vane heat - CHECK

NOTE

The following cockpit indications can occur when pitot heat operations on the ground exceed 30 seconds:

- a. YSAS can disengage and not reengage unless sufficient cooling airflow is generated (25 knots) or pitot heat is turned off and it cools sufficiently.
 - b. Due to vibration of the AOA vane transmitter heating element, an ADC PFL can be generated and all three AOA indexer lights may illuminate.
 - c. TAS is not available for display.
2. Pitch trim - CHECK FORE/AFT
Ensure stick repositions with activation of trim button in both directions.
 3. Aileron trim - CHECK NEUTRAL
Ensure aileron is faired with wing surface.
 4. Flight controls - CHECK

With normal movement, hydraulic pressure should not drop below 1500 PSI. Check visually for proper displacement and freedom of movement.



The artificial feel assembly makes abnormal flight control conditions difficult to detect by feel only; therefore, aircrew must visually confirm proper movement of the actual flight control surfaces.

5. Speed brake - CLOSED
6. FLAPS - CHECK
Flaps down to 60 %, full down, then retract to 60 %. The FLAP position indicator should

T.O. 1T-38C-1

be checked at $60 \pm 5\%$ when flaps are lowered or retracted. Visually note the trailing edge of the slab moves down continuously as the flaps are lowered. Also note the trailing edge of the slab moves up as the flaps are raised.

WARNING

Do not attempt flight if proper operation of the flap-slab interconnect system has not been verified. The leading edge of the horizontal tail must be aligned with the upper index mark on the fuselage at the 60% flap setting.

NOTE

ADC ADVISORY PFL & ADC MFL(s) 0-7 and/or 0-8 can be encountered when flaps are extended or retracted. The PFL advisory and MFLs indicate the flap synchro transmitter is out of range.

7. Cabin temperature/canopy defog - SET

WARNING

For night or anticipated weather operation with conditions of high humidity and narrow temperature-dew point spread, the canopies should be closed and the cabin temperature increased to the 100° AUTO position to preheat all flight instruments and canopy surfaces. Return temperature control to a comfortable in flight setting after completion of the BEFORE TAKE-OFF checklist.

- * 8. Survival kit (AUTO/MANUAL) - AS REQUIRED (if installed)
9. OXY/FUEL check switch - GAUGE TEST
Verify oxygen quantity decreases and oxygen low level caution light illuminates in both cockpits at approximately 1 liter remaining indication.
10. INS - CHECK
A full alignment is indicated by FULL on the MFD EGI display page and in the HUD after STAT.
11. EGI - NAV

NOTE

- Operation of the EGI in NAV mode without FULL ALIGNMENT degrades the performance of the EGI. This can result in erroneous operation.
- After commanding EGI into NAV via the UFCP, window 3R blinks ALN for approximately 3 seconds prior to displaying NAV. Pressing UR-3 on the UFCP EGI Key display places EGI back into alignment mode, continuing from when it was placed in NAV. Attempting a continued alignment following a SH alignment begins a GC alignment process from the beginning.

12. Yaw damper switch - YAW

13. Crossover relay - CHECK

Turn the L GEN switch off, and check for proper crossover indications (no PFLs, EED gauges remain normal). Turn the L GEN switch on. Turn the R GEN switch off, and check for proper crossover indications (no PFLs, HUD remains on, etc.). Turn the R GEN switch on.

NOTE

Following generator crossovers, HUD can blank momentarily, return in a full DIM, or full bright condition, or fail to return completely. The MDP can generate PFLs/MFLs or, in extreme cases, reboot after generator crossovers. If HUD intensity is affected (DIM/BRIGHT/no return) and/or UFCP HUD brightness control does not respond, cycle the front cockpit UFCP power switch. Check and set HUD brightness and resume normal operations.

*14. Seat height - ADJUST

WARNING

Ensure all equipment is stowed and clear of the handgrips to prevent inadvertent handgrip movement during seat adjustment. Whenever practical during ground operations, adjust the seat with the seat safety pin installed.

*15. Ejection seat and canopy safety pins - REMOVE AND STOW AS REQUIRED

*16. (AFTER T.O. 1T-38C-546) SAFE/ARMED handle - ARMED

*17. Brakes - CHECK PEDAL PRESSURE

18. Chocks - REMOVE

- Close and lock both canopies when taxiing directly behind another aircraft with engines running. Failure to do so can damage the canopy mechanism, possibly resulting in an inadvertent opening of either of the canopies.

1. Landing/taxi light - AS REQUIRED

* 2. Flight instruments - CHECK

If canopies are opened from the closed and locked position

3. Cabin pressure switch - RAM DUMP

WARNING

Loss of canopy and severe injury may occur if either canopy is unlocked prior to depressurizing to field elevation. The canopy could blow off its hinges and fall into the cockpit area. Anytime the aircraft has been pressurized, RAM DUMP must be selected and the cabin pressure checked prior to opening the canopy.

TAXIING

WARNING

If carbon monoxide contamination is suspected during ground operation, use 100 % oxygen.

CAUTION

- If brake drag is encountered or suspected, the aircraft should be aborted.
- Simultaneous use of wheel brakes and nosewheel steering to effect turns results in excessive nosewheel tire wear. Nosewheel tires are severely damaged when maximum deflection turns are attempted at ground speeds in excess of 10 knots.
- A low nose gear strut indicates insufficient strut pressure and may result in a cocked nosewheel and/or damage to the nosewheel well during retraction. Do not fly the aircraft if the nose gear strut is deflated or if the strut bottoms during taxiing.
- To prevent possible damage to the canopy downlock mechanism, taxi with both canopies open or both closed and pressurized whenever practical.

CAUTION

After placing the cabin pressure switch to RAM DUMP, ensure the cabin altimeter displays field elevation before opening the canopy. Pressure equalization may take several seconds.

4. Canopy - UNLOCKED

5. Cabin pressure switch - CABIN PRESS

BEFORE TAKEOFF

* 1. Takeoff data - UPDATE/REVIEW

2. BATTERY switch - CHECK ON

3. Cabin temperature/canopy defog - AS REQUIRED

4. Engine anti-ice - AS REQUIRED

* 5. Cockpit loose items - CHECK SECURED

* 6. Helmet visors - AS REQUIRED

T.O. 1T-38C-1

SEE SS-1

* 7. Flight controls - CHECK FOR FREE AND PROPER MOVEMENT

WARNING

The artificial feel assembly makes abnormal flight control conditions difficult to detect by feel only; therefore, aircrew must visually confirm proper movement of the actual flight control surfaces.

8. Takeoff trim button - PRESS
9. Nav aids/UFCP/master mode - AS REQUIRED
10. POSITION/landing/taxi lights - AS REQUIRED
- *11. Ejection seat and canopy safety pins - CONFIRM REMOVED AND STOWED
- *12. (AFTER T.O. 1T-38C-546) Confirm SAFE/ARMED handle - ARMED

WARNING

Take care to prevent inadvertent pulling of the canopy jettison T-handle when removing the safety pin.

- *13. Canopy - CLOSE, LOCK (warning light out)

WARNING

Ensure fingers are clear of canopy lock/unlock handle and aircraft bulkhead as they may become pinched between the handle on the canopy locking lever and the map light on the instrument panel.

CAUTION

- Before lowering the canopy, extend the instrument hood forward, as necessary, to ensure the hood is not bunched between the ejection seat drogue chute housing and the canopy or damage may occur to the seat or canopy.
- In the event of a canopy malfunction (difficulty in closing, opening, binding of the canopy or canopy handle during transit, or if the canopy unlocked light remains illuminated with canopy fully closed) do not move the aircraft or attempt further movement of the canopy without having the system checked by qualified maintenance personnel, unless a greater emergency exists as determined by the pilot in command. Efforts to close the canopy or vibrations set up by aircraft movement could result in canopy separation.
- Do not store objects or personal equipment on top of or behind the back seat ejection seat or damage to canopy mechanism or inadvertent canopy opening may occur.

TAKEOFF

See Figure 2-7 for takeoff procedures.

1. PITOT HEAT - ON

NOTE

The following cockpit indications can occur when pitot heat operations on the ground exceed 30 seconds:

- a. YSAS may disengage and not reengage unless sufficient cooling airflow is generated (25 knots) or pitot heat is turned off and it cools sufficiently.
- b. Due to vibration of the AOA Vane Transmitter heating element, an ADC PFL may be generated and all three AOA indexer lights may illuminate.
- c. TAS is not available for display.

2. Nose wheel steering - DISENGAGE
3. Throttles - MIL
4. EED - CHECK
5. Hydraulic pressures - CHECK
6. MASTER CAUTION and W/C/A lights - CHECK NOT ILLUMINATED
In addition to the MASTER CAUTION light and caution light panel, check the HUD and MFD for W/C/A indications.
7. Brakes - RELEASE
8. Throttles - MAX

WARNING

- Avoid wake turbulence. Allow a minimum of 2 minutes before takeoff behind any large type aircraft or helicopter and a minimum of 4 minutes behind heavy type aircraft. With effective crosswind of over 5 knots, the interval may be reduced. Attempt to remain above and upwind of preceding aircraft flight path.
- The takeoff should be aborted if either afterburner fails to light within 5 seconds or if the light off is abnormal.

NOTE

The acceleration check speed is the only means by which actual aircraft (engine) performance can be referenced to the computed values. Less than predicted acceleration will invalidate all computed speeds and associated distances.

9. Engine instruments - CHECK

CROSSWIND TAKEOFF

Aileron into the wind will aid in directional control and help in preventing compression of the downwind strut. The aircraft should be allowed to crab into the wind as rotation occurs.

AFTER TAKEOFF

1. Landing gear lever - LG UP, WHEN DEFINITELY AIRBORNE



Check the red light in the gear handle out prior to 240 KCAS.

2. FLAPS - UP

CLIMB

- * 1. Oxygen system - CHECK
- * 2. Fuel quantity/balance - CHECK
- 3. Cabin pressure - CHECK
- 4. CANOPY DEFOG and CABIN TEMP - AS REQUIRED

LEVEL-OFF AND CRUISE

- * 1. Oxygen system - CHECK
- * 2. Fuel quantity/balance - CHECK
- 3. Cabin pressure - CHECK
- * 4. Altimeters - CHECK

DESCENT

1. Armament safety check - COMPLETED
2. CMD switch - OFF
- * 3. Helmet visors - AS REQUIRED
- * 4. Heading and attitude system - CHECK
- * 5. Altimeters - CHECK AND SET
- * 6. Fuel quantity/balance - CHECK
7. CROSSFEED switch - OFF
8. CANOPY DEFOG, and CABIN TEMP - AS REQUIRED
9. PITOT HEAT - ON
10. ENGINE ANTI-ICE - AS REQUIRED
11. LDG TAXI LIGHT - ON
12. Master mode - SELECT (as required)

WARNING

When tuning the TACAN for penetration or approach as much as 2 minutes is required for the system to provide audio identification.

BASED ON GROSS WEIGHT OF 12,800 POUNDS

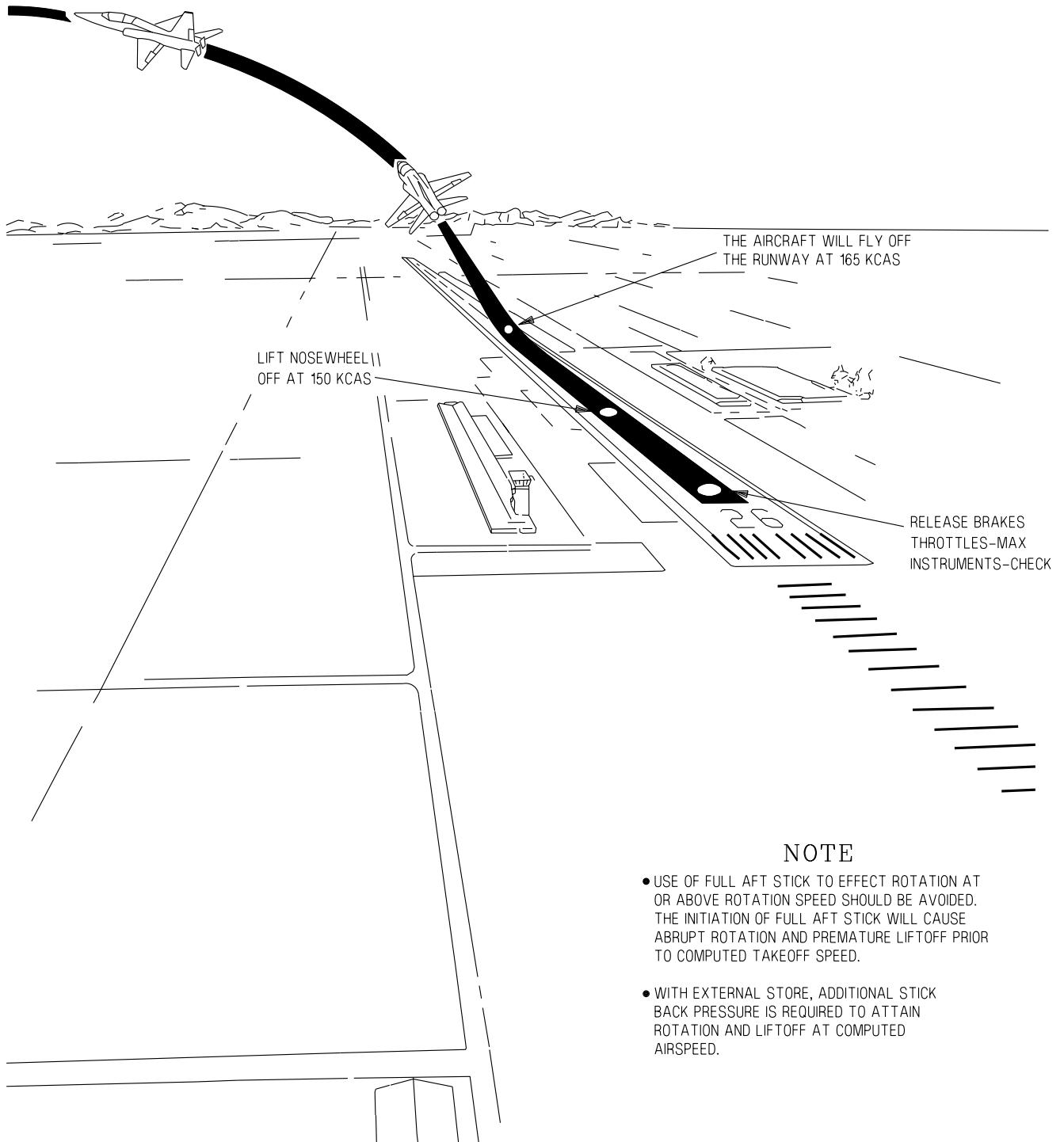

NOTE

- USE OF FULL AFT STICK TO EFFECT ROTATION AT OR ABOVE ROTATION SPEED SHOULD BE AVOIDED. THE INITIATION OF FULL AFT STICK WILL CAUSE ABRUPT ROTATION AND PREMATURE LIFTOFF PRIOR TO COMPUTED TAKEOFF SPEED.
- WITH EXTERNAL STORE, ADDITIONAL STICK BACK PRESSURE IS REQUIRED TO ATTAIN ROTATION AND LIFTOFF AT COMPUTED AIRSPEED.

Figure 2-7. Normal Takeoff

BEFORE LANDING

See Figure 2-8 for pattern speeds.

- * 1. Pattern airspeeds - COMPUTE
- * 2. Landing gear lever - LG DN & CHECK DOWN
Physically press the front cockpit lever full down.



Failure of the landing gear lever interconnect cable while the landing gear is being lowered from the rear cockpit may result in normal gear extension without full down travel of the front landing gear lever, leading to possible uncommanded gear retraction on landing. To preclude this, the front landing gear lever shall be physically checked full down anytime the gear is lowered from the rear cockpit.

- * 3. Hydraulic pressure - CHECK
- * 4. FLAPS - AS REQUIRED

LANDING



Avoid wake turbulence. Allow a minimum of 2 minutes before landing behind any large type aircraft or helicopter and a minimum of 4 minutes behind heavy type aircraft. With effective crosswinds of over 5 knots, the interval may be reduced. Attempt to remain above and upwind of the preceding aircraft flight path. See section VI.

NORMAL LANDING

Normal landings are performed using flaps at 60 % or full down. Refer to Figure 2-8 for recommended landing and go-around pattern. After touchdown, continue to increase back pressure on the stick to obtain the highest possible nose high attitude without flying the aircraft off the runway.

For BEFORE-PMP aircraft, just prior to loss of elevator authority, lower the nosewheel to the runway. After nosewheel is lowered to the runway, a single, smooth brake application should be used to stop.

For AFTER-PMP aircraft, the Landing Distance chart assumes the pilot will maintain a nose high pitch attitude down to the aero-brake speed and lower the nosewheel to the runway. Refer to T.O. 1T-38C-1-1, Figure B7-1. After nosewheel touchdown the pilot will gradually apply wheel brakes so that the desired braking is reached in two seconds. Wheel braking is limited to cautious braking from 130 KCAS to 100 KCAS, with optimum braking below 100 KCAS.

Variation in landing technique could increase landing distance as much as 50 % from that computed from the landing distance chart in T.O. 1T38C-1-1, Part 7 of Appendix A or Appendix B.



- Extreme caution must be exercised when applying wheel brakes above 120 KCAS as locked wheels or tire skids are difficult to recognize. If tire skids are detected, immediately release both brakes and cautiously reapply.
- Attempting to aerobrake using full back stick until the nose can no longer be held up will produce a hard nosewheel impact at approximately 100 KCAS.
- Extreme nose high aerobraking when crossing raised arresting cables may result in damage to the afterburner ejectors.
- Rubber deposits on the last 2000 feet of wet runways make directional control difficult even at very low speeds. Braking should be started in sufficient time so as not to require excessive braking on the last portion of the runway.

NOTE

INCREASE FINAL TURN, FINAL APPROACH, AND TOUCHDOWN SPEEDS 1 KNOT FOR EACH 100 POUNDS OF FUEL AND STORES REMAINING ABOVE 1000 POUNDS.

INCREASE FINAL APPROACH AND TOUCHDOWN SPEEDS BY HALF THE GUST FACTOR.

ENTER TRAFFIC PATTERN AT 300 KCAS

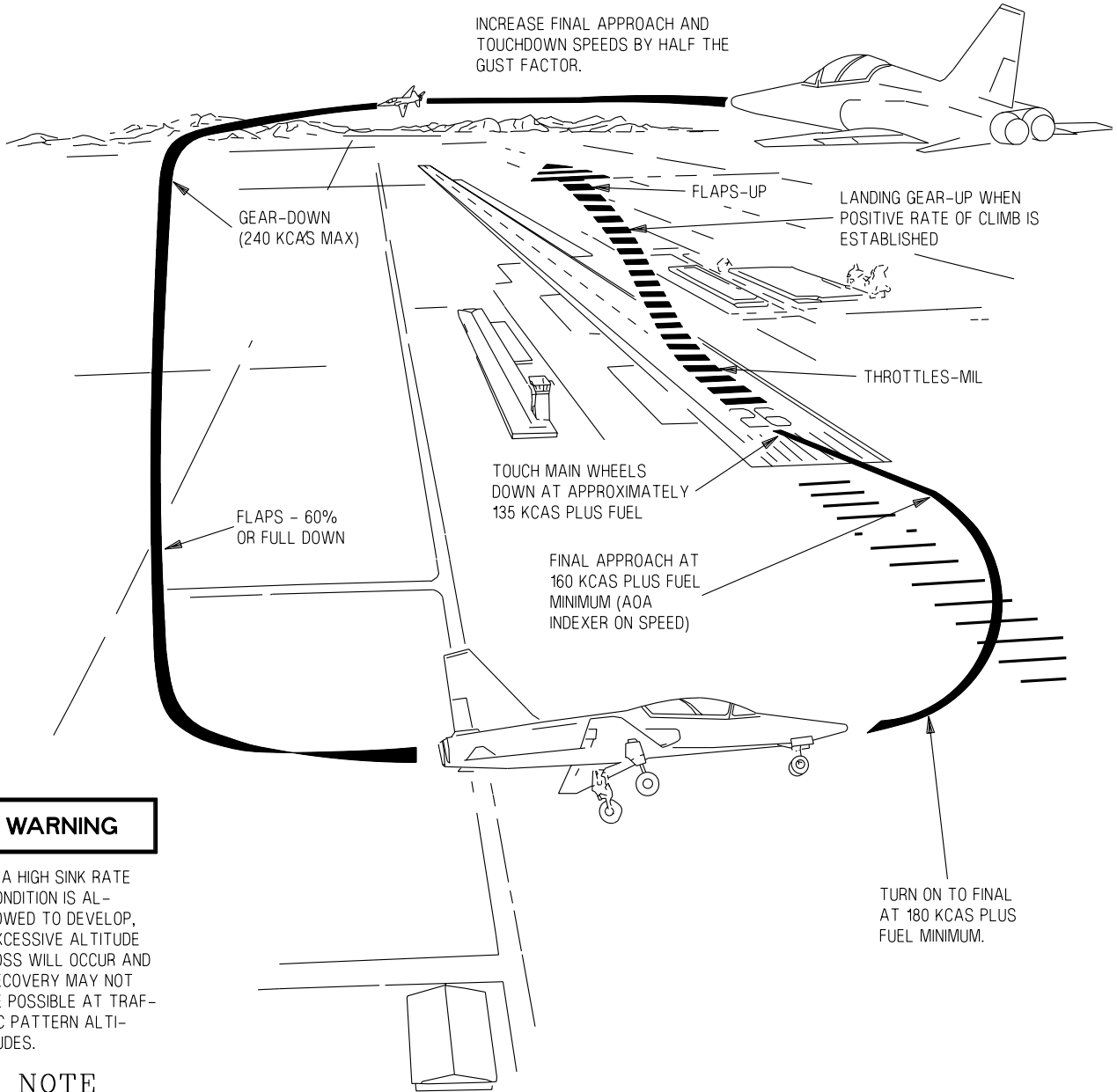

WARNING

IF A HIGH SINK RATE CONDITION IS ALLOWED TO DEVELOP, EXCESSIVE ALTITUDE LOSS WILL OCCUR AND RECOVERY MAY NOT BE POSSIBLE AT TRAFFIC PATTERN ALTITUDES.

NOTE

FUEL REQUIRED FOR GO-AROUND (CLOSED PATTERN) IS APPROXIMATELY 150 POUNDS.

Figure 2-8. Landing and Go-Around Pattern

MINIMUM ROLL LANDING

Decrease airspeed 10 knots below normal landing final approach airspeed to make sure touchdowns at speeds noted in the landing distance chart in T.O. 1T-38C-1-1. The landing distance chart shows data for landing at computed touchdown speed at approximately 12° nose high attitude. Just prior to loss of elevator authority, lower the nosewheel to the runway and apply optimum wheel braking. For wet runways, a firm touchdown will tend to reduce the effects of hydroplaning.

CROSSWIND LANDING

Approach and Touchdown

On final approach, counteract drift by crabbing into the wind, maintaining flight path alignment with the runway. The crab should be held through touchdown. When the crosswind component exceeds 15 knots, touchdown should be planned for the upwind side of the runway. Maintain precise airspeed control throughout the final approach; in gusty conditions, increase the indicated airspeed by one half of the gust increment above the wind velocity. Refer to section V for landing rate of descent.



When the crosswind component exceeds 15 knots, limit touch and go landings due to increased tire wear and the risk of blown tires.

After Touchdown

Do not commence a normal aerobrake; however, the landing attitude should be maintained by increasing back pressure on the stick. The ground run distance may increase as much as 50% due to the decreased aerodynamic braking and less than optimum wheel braking. Aileron into the wind will aid in directional control, will help in preventing compression of the downwind strut, and will prevent the upwind wing from becoming airborne. Maintain directional control of the aircraft with the rudder. A too rapid increase in the back stick pressure may cause the aircraft to become airborne and drift across the runway. Drift will create a high probability of tire damage. Just

prior to loss of elevator authority, lower the nosewheel to the runway.



Attempting to aerobrake using full back stick until the nose can no longer be held up will produce a hard nosewheel impact at approximately 100 KCAS.

Lowering the nose prematurely in a crosswind will produce a compression of the downwind strut. This hampers directional control and may be minimized by use of aileron. Early downwind strut compression combined with weathervaning usually results in damage to the downwind tire.

USE OF WHEEL BRAKES

Wheel Brake Operation

To minimize brake wear, the brakes should be used as little and as lightly as possible. If the first application of brakes does not provide adequate pressure or if the brakes feel spongy, normal pressure might be regained by pumping the brake pedals. The pedals should be allowed to return to the full up position between strokes. Failure of certain brake components within a cockpit may result in complete failure of one or both brakes. If this occurs, braking might be gained by operating the brakes in the other cockpit. Full advantage of the runway length should be taken during landing or aborted takeoff. Minimize use of brakes during turns and avoid dragging the brakes during taxiing. When there is considerable lift on the wings, such as immediately after touchdown, heavy brake pressure will lock the wheel more easily than when the same pressure is applied after the full weight of the aircraft is on the tires. Once a wheel is locked, it may be necessary to completely release brake pressure to allow wheel rotation.

Optimum Braking Action

The physical limitations of the tire and brake system make it extremely difficult to consistently achieve optimum brake action, particularly at high speeds (above 120 KCAS), where the weight component is reduced due to lift. A single, smooth application, increasing as airspeed decreases, offers the best braking opportunity. Use caution when braking at speeds above 100 KCAS. Locked brakes are difficult to diagnose until well after the fact. Braking should be

T.O. 1T-38C-1

discontinued at the first indication of directional problems and then cautiously reapplied. At speeds below 100 KCAS, the chances of approaching optimum braking action are greatly increased.

WARNING

- Braking required for high speed, heavy gross weight abort may result in extremely hot brakes or brake failure and the possibility of tire fire should be anticipated.
- If hot brakes are suspected, the aircraft should not be taxied into a congested area. Ensure all personnel remain clear of the main wheels until they have cooled.

GO-AROUND

Make the decision to go-around as early as possible. Military power is normally sufficient for go-around, but do not hesitate to use maximum power if necessary.

WARNING

If conditions do not permit an aerial go-around, do not try to hold the aircraft off the runway; continue to fly the aircraft to touchdown and follow the go-around procedure.

1. Throttles - MIL (MAX if necessary)
2. Landing gear lever - LG UP, WHEN DEFINITELY AIRBORNE
3. FLAPS - UP

NOTE

If touchdown is made, lower the nose slightly to accelerate. Establish takeoff attitude to allow the aircraft to fly off the runway at takeoff speed.

TOUCH AND GO LANDINGS

To make a touch and go landing, perform the desired approach and landing. After touchdown, follow the normal go-around procedure.

WARNING

Touch and go landings encompass all aspects of the landing and takeoff procedures in a relatively short time span. Be constantly alert for possible aircraft malfunctions and/or unsafe pilot technique during these two critical phases of flight.

AFTER LANDING

- * 1. (AFTER T.O. 1T-38C-546) SAFE/ARMED handle - SAFE
- * 2. Seat and canopy safety pins - INSTALL

WARNING

Ensure the seat safety pin is installed and all equipment is properly secured to prevent entanglement with the ejection seat hand grips and possible hand grip movement during egress.

3. PITOT HEAT - OFF

NOTE

The following cockpit indications can occur when pitot heat operations on the ground exceed 30 seconds:

- a. YSAS can disengage and not reengage unless sufficient cooling airflow is generated (25 knots) or pitot heat is turned off and it cools sufficiently.

- b. Due to vibration of the AOA Vane Transmitter heating element, an ADC PFL can be generated and all three AOA indexer lights can illuminate
- c. TAS is not available for display .
- * 4. Loose items - CHECK SECURED (before opening canopy)
- 5. CABIN PRESS switch - RAM DUMP
- 6. Cabin altimeter - CHECK
If reading is below field elevation write up the failure in the AFTO Form 781.



After placing the cabin pressure switch to RAM DUMP, ensure the cabin altimeter displays field elevation before opening the canopy. Pressure equalization may take several seconds.

- * 7. Canopy - UNLOCKED



Loss of canopy and severe injury can occur if either canopy is unlocked prior to depressurizing to field elevation. The canopy could blow off its hinges and fall into the cockpit area. Anytime the aircraft has been pressurized, RAM DUMP must be selected and the cabin pressure checked prior to opening the canopy.



In the event of a canopy malfunction (difficulty in closing, opening, binding of the canopy or canopy handle during transit, or if the canopy unlocked light remains illuminated with canopy fully closed), do not move the aircraft or attempt further movement of the canopy without having the system checked by qualified maintenance personnel, unless a greater emergency exists as determined by the pilot in command. Efforts to close the canopy or vibrations set up by aircraft movement could result in canopy separation.

- 8. Gear door switch - OPEN
- 9. TAKEOFF TRIM button - PRESS

- 10. FLAPS - UP

NOTE

ADC ADVISORY PFL and ADC MFLs 0-7 and/or 0-8 may be encountered when flaps are extended or retracted. The PFL Advisory and MFLs indicate the flap synchro transmitter is out of range.

- 11. Speed brake - OPEN
- 12. LDG TAXI LIGHT - AS REQUIRED
- 13. CABIN PRESS switch - CABIN PRESS
- 14. VTR - STOP



The VTR must be properly shut down or the VTR tape remains threaded. Improper removal of the VTR tape will result in VTR and tape damage.

- 15. Data download - CONFIRM INITIATED

ENGINE SHUTDOWN

- 1. Operate engines at 70 % RPM or below for a minimum of 1 minute for engine cooling.
- * 2. Seat - FULL UP
- 3. POSITION lights - OFF
- 4. FORMATION lights - OFF
- * 5. Oxygen - 100 %
- 6. Data download - CONFIRM COMPLETE, IF NOT ALREADY ACCOMPLISHED IN STEP 15 ABOVE
- * 7. Standby attitude indicator - CAGE AND LOCK
- * 8. UFCP - OFF
- * 9. MFD - OFF
- 10. AAP
 - a. TCAS - OFF
 - b. MDP - OFF
 - c. EGI - OFF

T.O. 1T-38C-1

d. Backup Mode Control Knob - NORM



The EGI must be allowed at least 10 seconds of power after shut down command via the AAP. This allows the EGI to store necessary data used for initial alignment and the BIT results from the current power cycle. Failure to allow EGI to complete the storage operation can corrupt the stored data and could cause the next EGI alignment to fail completely or be inaccurate. Stored data necessary for troubleshooting faults will be lost.

NOTE

Aircrew shutdown of avionics immediately prior to the initial tire and wheel check assures sufficient time for the EGI to store memory and VTR to successfully unthread the High 8mm tape.

11. Throttle gate - DISENGAGE (if installed) (FCP only)
12. Throttles - OFF

NOTE

- After EGI shutdown, wait 10 seconds for the EGI to store present position data before engine shutdown.
- Allow 10 seconds for landing-taxi light retraction and/or closure of ram dump door prior to engine shutdown.
- The EED fuel flow indicator(s) may read as high as 60 PPH.

13. Rotating BEACON - OFF
- *14. EED - OFF
15. Backup NAV/UHF - OFF
16. TACAN backup controller - OFF
17. Wheels - CHOCKED
- *18. Silver key - SECURED

19. BATTERY switch - OFF

- *20. (AFTER T.O. 1T-38C-546) Personal equipment, harness release fittings, lap-strap connectors, SSK attachment straps, and leg garters - DISCONNECT
21. (AFTER T.O. 1T-38C-546) (RCP) ISS mode selector - SOLO
22. Post flight exterior inspection - COMPLETE
Look for any abnormalities, such as missing panels, damaged tires, leaking fluids, scrapes, dents, or evidence of birds strikes, and notify maintenance personnel.



Ensure seat safety pin is installed and all equipment is properly secured to prevent entanglement with (BEFORE T.O. 1T-38C-546) ejection seat handgrips, or (AFTER T.O. 1T-38C-546) seat ejection handle and possible (BEFORE 1T-38C-546) handgrip movement or (AFTER T.O. 1T-38C-546) seat ejection handle movement, during egress.

NOTE

(AFTER T.O. 1T-38C-546) SAFE/ARMED handle must be in SAFE to install seat ejection handle safety pin.

INSTRUMENT FLIGHT PROCEDURES

NOTE

When an unusual attitude is suspected or confirmed, if practical, transition to the MFD for unusual attitude recovery. While the HUD is sufficient for unusual attitude recoveries, the MFD with the use of color expedites recovery.

INSTRUMENT TAKEOFF

For an instrument takeoff, perform all normal pre-takeoff checks and turn on pitot heat and engine anti-ice system, if necessary. Allow for increased

takeoff roll if engine anti-ice is used. Check the EHSI for proper heading.

Whenever visibility permits, runway features and lights should be used as an aid to maintain proper headings. Adjust back stick pressure to attain the takeoff attitude and allow the aircraft to fly off the runway. When vertical velocity indicator and altimeter indicate a definite climb, retract the landing gear. Raise the wing flaps immediately after the landing gear lever has been placed at LG UP.

INSTRUMENT CLIMB

Approaching 300 KCAS in a 5° climb indication, retard throttles to MIL thrust. Maintain a 2-5° climb indication and at least a 1000 FPM climb until reaching recommended climb schedule. A slow airspeed and/or low rate of climb may be required to comply with departure procedures. For this type climb, reduce power below MIL as required. Power settings between 90 % and 95 % RPM will provide comfortable climb rates at 300 KCAS for intermediate altitude level-offs. MAX thrust instrument climbs require extremely high pitch angles and are not normally used for instrument departures. If conditions require a MAX thrust climb, maintain a 2-5° climb indication until approaching recommended climb Mach, then rotate to approximately a 20-25° initial climb indication.

HOLDING PATTERNS

Hold at 250-265 KCAS at all altitudes. To descend in holding patterns, reduce power and maintain holding airspeed in descent. The speed brake may be used for holding pattern descents, but higher descent rates must be anticipated.

PENETRATION DESCENTS

Prior to penetration descent, the canopy defog system should be operated at the highest flow possible (consistent with crewmembers' comfort) during high altitude flight to prevent the formation of frost or fog during descent.

To enter a penetration descent, reduce power and lower the nose as required. Open speed brake (if required) at 300 KCAS and maintain by adjusting pitch as required. If a turn is required, limit bank angle to 30°. Initiate the level-off from a penetration descent 1000 feet or more above the desired altitude by decreasing the pitch attitude by approximately one half. Use normal lead point for level-off at the

desired altitude. When inbound to the final approach fix, maintain airspeed of 300 KCAS in a clean configuration. The speed brake may be left open or closed as required to obtain the desired airspeed at the final approach fix.

NOTE

For engine anti-ice operation, 80 % RPM or above is recommended.

INSTRUMENT APPROACHES

Figure 2-9 shows a typical TACAN penetration and approach. Normally, a maximum of 300 KCAS will be maintained during approach maneuvering prior to extending the gear. Recommended final approach airspeed will depend upon the type of approach being made. AOA indexer will show a fast indication during final approach maneuvering and on speed indication after final approach fix. For a straight-in approach, maintain 160 KCAS plus fuel minimum (AOA indexer on speed).

NOTE

Increase final approach and touchdown speeds by half the gust factor.

RADAR APPROACHES

Refer to Figure 2-10 for aircraft configuration.

INSTRUMENT LANDING SYSTEM

Transmission on the lower UHF antenna may interfere with the ILS and cause pitch steering to blank. The upper UHF should always be used on approach. The Comm Antenna switch should be in AUTO or UPPER to accomplish this.

Refer to Figure 2-11 for aircraft configuration. Enter the approach at a maximum of 300 KCAS in clean configuration. At transition to final approach lower landing gear and flaps to 60 % or full down. When established on glide slope make sure gear is down, flaps are 60 % or full down, and maintain 160 KCAS plus fuel minimum. Maintain AOA indexer at on speed condition.

T.O. 1T-38C-1

NON PRECISION APPROACHES

Normally, a maximum of 300 KCAS will be maintained during approach maneuvering prior to extending the gear. Recommended final approach airspeed will depend upon the type of approach being made. AOA indexer will show a fast indication during final approach maneuvering and an on-speed indication after final approach fix. For a straight-in approach, maintain 160 KCAS plus fuel minimum (AOA indexer on speed).

NOTE

Increase final approach and touchdown speeds by half the gust factor.

1. Tune, identify and monitor.
2. PNS - SELECT
3. Course arrow and course - SET

NOTE

With the localizer front course selected, the aircraft symbol is always directional in relation to the CDI.

4. Flight director - AS REQUIRED
5. Bank steering bar - CENTERED (FD ON)

WARNING

If the published front course has not been set in the course selector window, the bank steering bar will be unreliable.

6. CDI - CROSS CHECK

ILS APPROACH

WARNING

Transmission on lower UHF antenna can interfere with ILS and cause glideslope raw data and pitch steering bar to blank. COMM ANTENNA select switch should be in AUTO or UPPER to ensure upper UHF antenna is used on approach.

1. ILS/DME frequencies - SET

WARNING

When tuning the TACAN for penetration or approach as much as 2 minutes is required for the system to provide audio identification.

2. ILS - SELECT (as PNS)
Tune, identify and monitor station.
3. Course arrow and course window - SET
LOCALIZER FRONT COURSE

NOTE

With the localizer front course selected, the aircraft symbol is always directional in relation to the CDI.

4. Flight director - AS REQUIRED
5. Bank steering bar - CENTER
Keeping the bank steering bar centered will maintain the aircraft on or correct it to the localizer course. Wind drift corrections are accomplished automatically.

WARNING

If the published front course has not been set in the course selector window, the bank steering bar will be unreliable.

NOTE

The bank steering bar will command excessive or erroneous steering indications if the aircraft is not on or near the localizer course when ILS is selected.

6. Pitch steering bar - CENTER
As the VDI approaches mid-scale, adjust the pitch to center the pitch steering bar. Keeping the pitch steering bar centered will maintain the aircraft on or correct it to the glideslope.
7. CDI and VDI - CROSS CHECK THROUGHOUT THE APPROACH

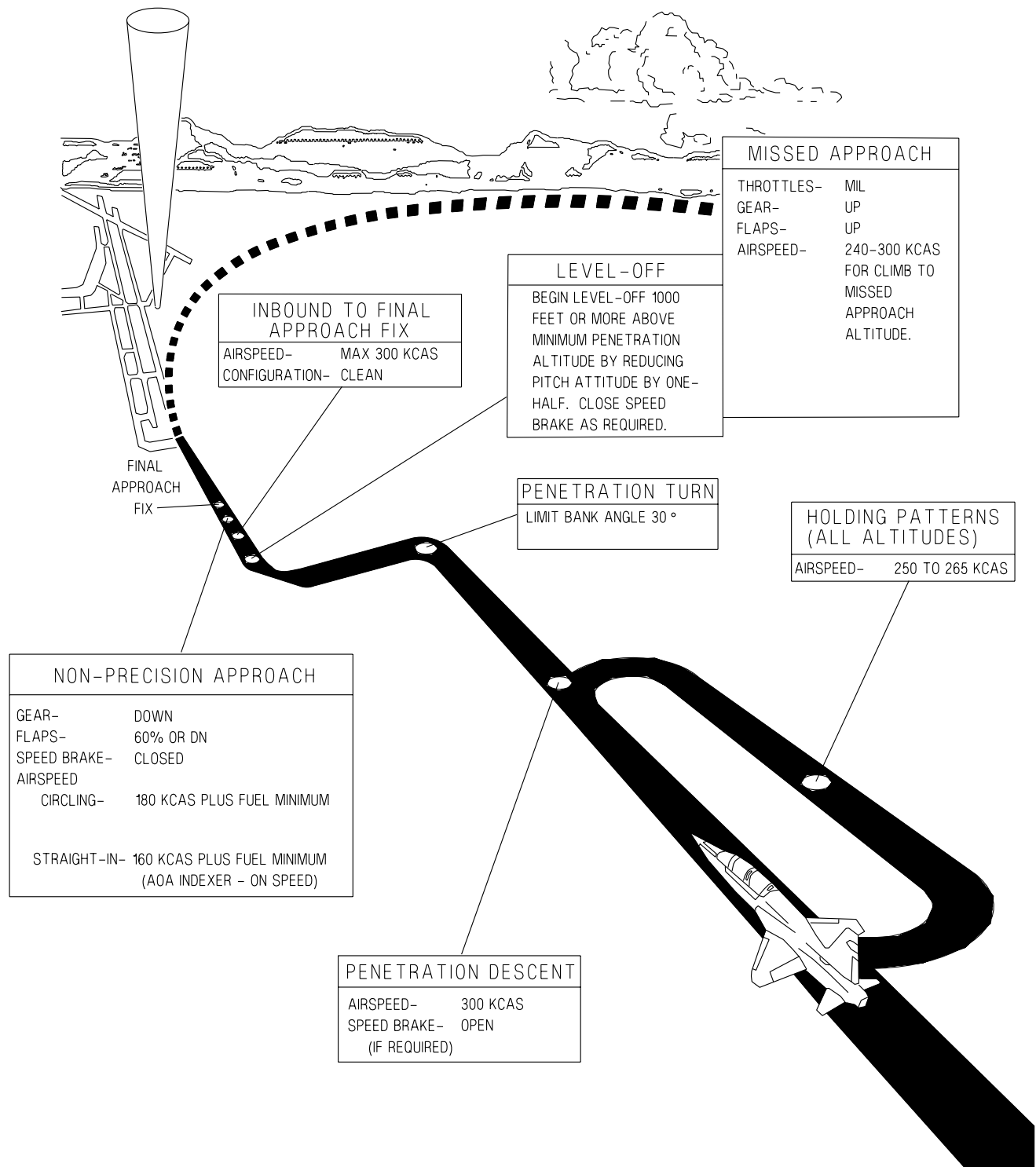

Figure 2-9. Tacan Holding, Penetration and Approach (Typical)

T38002-189-1-020

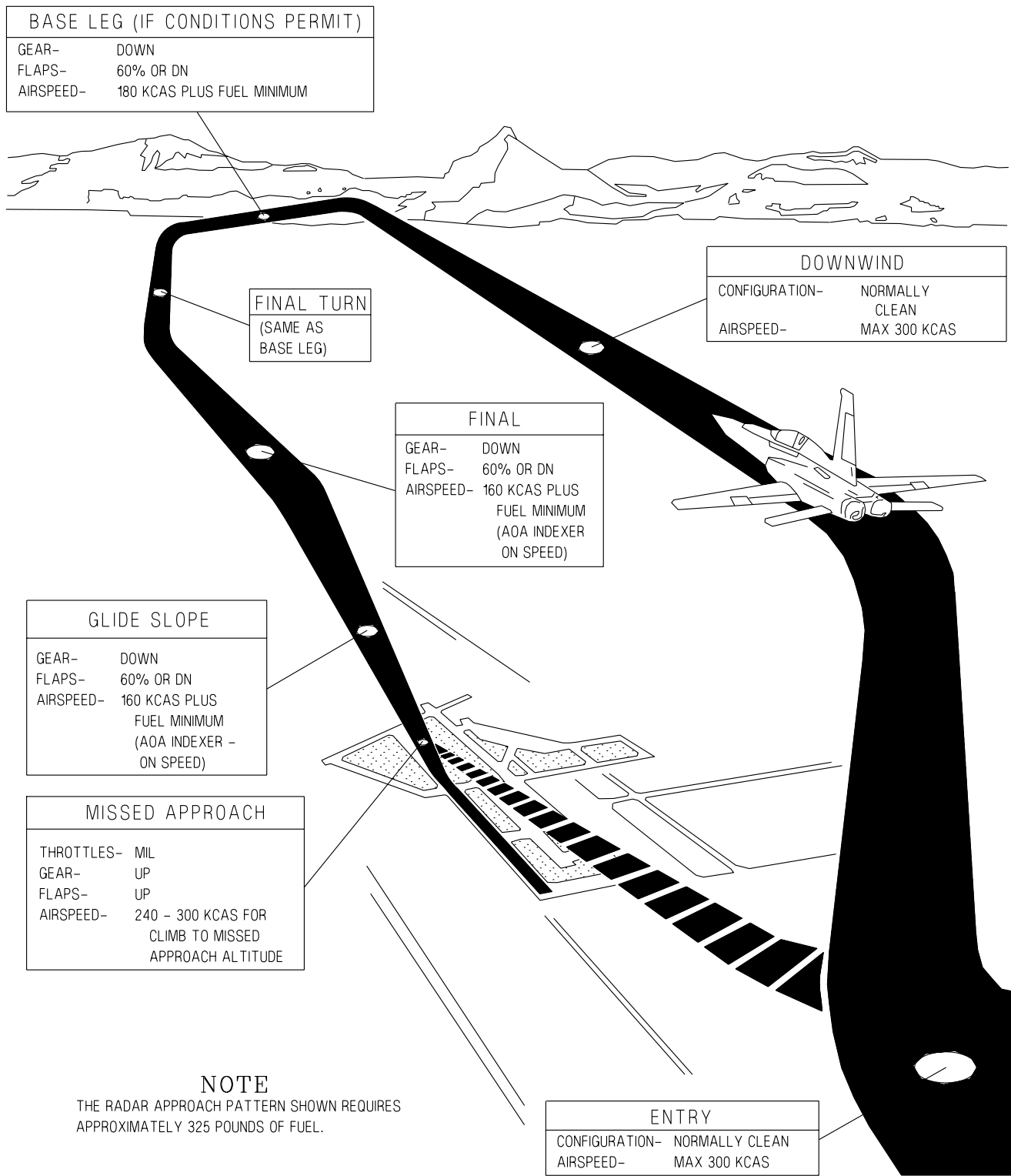

Figure 2-10. Radar Approach (Typical)

T38002-191-1-021

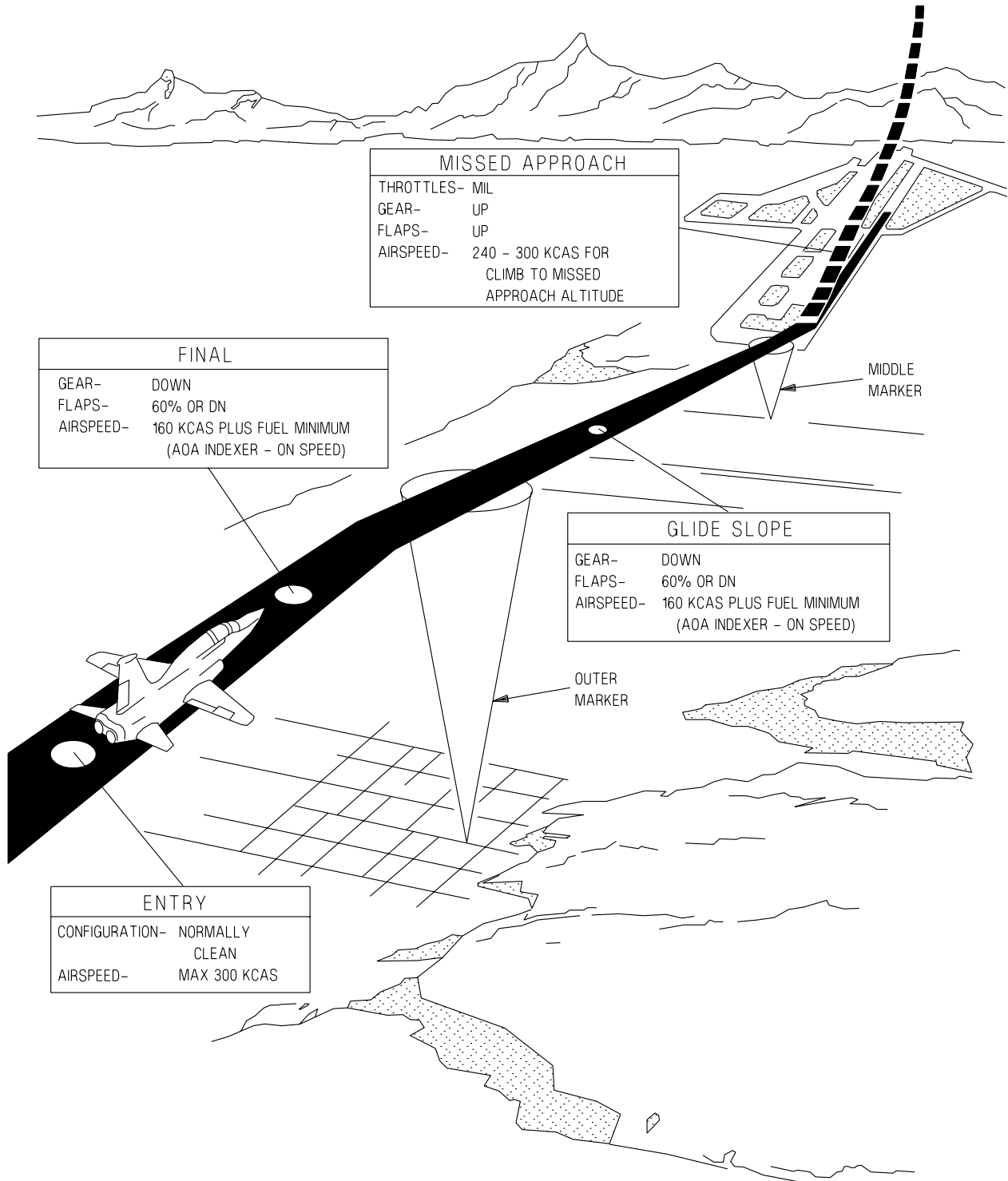

Figure 2-11. ILS Approach (Typical)

T38002-193-1-021

CIRCLING APPROACHES

A circling approach is a visual maneuver flown at a lower altitude than a normal VFR overhead traffic pattern. The pilot's shallower look angle to the runway causes a tendency to fly a downwind and/or a base leg that is too close to the runway, thus increasing the possibility of an overshoot or steeper than normal final approach. Ensure sufficient downwind and/or base leg displacement prior to initiating the turn to final approach. As the circling maneuver may initially be a level turn, aircraft configuration will require higher power settings than those used in an overhead traffic pattern. Bank angles in excess of 45° may make a level turn impossible under some conditions of heavy gross weights, high temperatures and pressure altitudes. Maintain 180 KCAS plus fuel minimum and 60% flaps until transitioning to a normal final. AOA indications will vary depending on airspeed, bank angle, and back pressure applied during the circling maneuver.

MISSED APPROACH PROCEDURE

To accomplish a missed approach, advance throttles to MIL, close speed brake (if open) as power is applied, and rotate the aircraft to normal instrument takeoff attitude. Retract landing gear and flaps as in an instrument takeoff and accelerate to 240-300 KCAS. Climb at 240-300 KCAS to missed approach altitude. Power may be reduced to 90-95% to provide a more controllable rate of climb.

FUEL BALANCING

CROSSFEED

Crossfeeding is recommended when fuel differences exceed 200 pounds. Attempt to enter the traffic pattern in a fuel-balanced condition. Differential power settings should be used to balance fuel to avoid use of crossfeed operation during low fuel conditions.

Crossfeeding is not recommended when:

- a. Boost pump is inoperative.
- b. There is a fuel quantity failure.
- c. There is a leak in the fuel system.
- d. Aircraft is at low altitude.
- e. Aircraft is in a low fuel state.

If a fuel gage shows FAIL, do not crossfeed.

1. CROSSFEED switch - ON

2. BOOST PUMPS switch on side of lower fuel quantity - OFF

WARNING

- With the crossfeed switch ON and either both boost pumps ON, or both boost pumps OFF, a rapid fuel imbalance can occur.
 - If crossfeed operation is continued until the active system runs dry, dual engine flameout will occur.
3. BOOST PUMPS switches - BOTH ON WHEN QUANTITIES ARE EQUAL
 4. CROSSFEED switch - OFF

UHF CONTROL VIA UHF BACKUP CONTROL PANEL

NOTE

UHF Backup Control Panel display illuminates only in backup mode (MDP off or failed) or when AAP Backup Mode Control Knob is in UHF B/U or BOTH.

PRESET CHANNEL SELECTION

1. AAP backup mode control knob - UHF B/U
2. UHF backup control panel power knob - ON
Pressing knob alternately applies/removes squelch.
3. CHAN button - PRESS
Channel number and CH, or GD, (upper line) and tuned frequency (lower line) shown in display window.
4. Frequency/channel select knob - ROTATE TO SELECT DESIRED CHANNEL
Both knobs change channels.

MANUAL FREQUENCY SELECTION

1. AAP backup mode control knob - UHF B/U
2. UHF backup control panel power knob - ON
Pressing knob alternately applies/removes squelch.

If preset channel displayed -

3. CHAN button - PRESS
Upper display window blanks. Frequency shown in lower display window.

4. Frequency/channel select knob - ROTATE TO DESIRED FREQUENCY
Outer knob changes frequency in 1-MHz steps; inner knob changes frequency in 25-KHz steps.

PROGRAMMING PRESET OR GUARD CHANNELS

1. CHAN button - PRESS AND HOLD FOR MORE THAN 3 SECONDS
Program mode activated. Channel number is displayed, preceded by P or GDP (for guard channel).
2. Frequency/channel select knob - ROTATE TO SELECT DESIRED PRESET CHANNEL TO BE PROGRAMMED.
3. MODE button - PRESS
Frequency row flashes.
4. Frequency/channel select knob - ROTATE TO SELECT DESIRED FREQUENCY
5. MODE button - PRESS
Frequency is stored to channel.
6. Repeat steps 2 thru 5 for other channels.
7. CHAN button - PRESS AND RELEASE
Program mode exited.

NOTE

Program mode also exits after 20 seconds of inactivity.

NAV BACKUP CONTROL PANEL

NOTE

NAV Backup Control Panel display illuminates only in backup mode (MDP off or failed) or when AAP Backup Mode Control Knob is in NAV B/U or BOTH.

FREQUENCY SELECTION

1. AAP Backup Mode Control Knob - NAV B/U
2. NAV Backup Control Panel Mode Knob - ON
3. Frequency select knob - ROTATE TO DESIRED FREQUENCY
Outer knob changes frequency in 1-MHz increments. Inner knob changes frequency in 50-KHz increments.

MANUAL DATA TRANSFER

1. MFD DTS display page - SELECT (MB-6) FROM MFD MENU Display Page
When the DTC is not inserted into the DTD, NO CASSETTE is displayed on the DTS page.

NOTE

Use care to install DTC right side up. Correct position is arrow side up, with arrow facing forward, toward nose of aircraft. If DTC does not lock into position easily, remove, examine, reposition correctly (if required) and reinstall if not damaged. Forcing an incorrectly positioned (upside down or backwards) DTC into a DTD causes NO CASSETTE to appear and can damage the DTD. An incorrectly installed DTC can jam in the DTD.

Transferring data from cartridge to aircraft -

1. LOAD TO MDP - PRESS (ML-3)
2. OPERATIONAL 1 - PRESS (ML-3)
The following data can be transferred to the MDP via the LOAD OP 1 display page:
 - a. WPN - weapon data
 - b. FPL - list of 15 flight plans and relevant parameters
 - c. ALERT - Altitude alert settings and Bingo values
 - d. CLOCK - ΔT from GMT to adjust GPS time to local time
 - e. ALL - entry of all the data mentioned above if available
3. OPERATIONAL 2 - PRESS (ML-4)
The following data can be transferred to the MDP via the LOAD OP 2 Display page:
 - a. APP - approach patterns, parameters and DST # allocation
 - b. DST - list of DST points

T.O. 1T-38C-1

- c. ICAO - list of ICAO points

WARNING

Attempting to load ICAO data inflight causes the MDP to freeze the attitude displays, (EADI and HUD) and stop data processing for approximately 80 seconds. Takeoff should not be initiated during the 80 seconds.

- d. ZONE - Training and no-fly zones
- e. TCAS - EMER and VFR codes
- f. UHF - UHF radio channel/preset allocation
- g. VHF - VHF radio channel/preset allocation
- h. DCL - MFD and HUD declutter options
- i. MAP - HSD Map symbols
- j. ALL (EX ICAO) - All the data mentioned above (if available) except the ICAO points

Automatic post flight data transfer from aircraft to cartridge

Automatic data transfer of the flight's data is initiated 30 seconds after landing. Landing is defined as WOW and speeds below 60 KCAS. After 30 seconds the status indicates DTS IDLE for 10 seconds, then DTS ACTIVE for approximately 20 seconds, then DOWNLOAD COMPLETE is displayed on the MFD LOAD TO DTD display page. DOWNLOAD COMPLETE remains displayed until the cartridge is removed, MDP power is cycled, or an aircrew initiated data transfer is performed.

NOTE

- Aircrew should not eject the DTC until the DOWNLOAD COMPLETE indication is displayed on the MFD LOAD TO DTD Display Page.
- If DOWNLOAD ERROR is displayed on the LOAD TO DTD Display Page after landing then an aircrew initiated download ALL should be attempted.
- For ground aborts, automatic data transfer is not accomplished. An aircrew initiated download LAST should be attempted.

Aircrew initiated post flight data transfer from aircraft to cartridge

NOTE

An aircrew initiated download should not be performed if DOWNLOAD COMPLETE is displayed after flight.

After Flight if DOWNLOAD ERROR is displayed -

1. MFD DTS display page - PRESS (MB-6) from MFD MENU display page
2. LOAD TO DTD - PRESS (MR-3)
3. ALL - PRESS (MR-4)

Ground Abort -

1. MFD DTS display page - PRESS (MB-6) from MFD MENU display page
2. LOAD TO DTD - PRESS (MR-3)
3. LAST - PRESS (MR-3)

STRANGE FIELD PROCEDURES

The following information provides guidance for operation at fields that do not normally support the aircraft.

1. Oil: Use MIL-L-7808 (NATO 0-148).
Alternate: None.
Check oil level immediately after flight.
2. Fueling: Use JP-8 (NATO F-34), JP-8 + 100, Jet A with FSII, or Jet A-1 with FSII.
 - a. Single-point - Use a 45-55 PSI system no flow pressure. After fuel flow starts, expect a drop in pressure. Do not increase fuel flow pressure during refueling. Start fuel flowing and then move the precheck valve handle, located next to the single-point fueling adapter, to the PRIM (primary) position. Fuel flow should stop within 10 seconds. Stoppage is indicated by fuel flow not greater than 10 gallons per minute at fuel truck meter. Return precheck valve handle to OFF. Allow fuel flow to continue for a short duration and then place precheck valve handle in the SEC (secondary) position. Fuel flow should stop within 10 seconds. Return precheck valve handle to OFF position and continue refueling. If fuel flow fails to stop in both check positions, do not use single-point refueling.
 - b. Manual - Service left system first or aircraft may settle on tail.

3. Oxygen: Use MIL-O-27210.
4. Hydraulic fluid and brake fluid: Use MIL-H-5606 (NATO H-515) or MIL-H-83282 (NATO H-537).
5. Tire pressure:
Main - 265 PSI. Nose - 75 PSI.
6. Loose fasteners: Use Torq-set bit.
7. Air starting units:
Air Force - MA-1, MA-1A, MA-1MP, MA-2, MA-2MP, M32A-60, MA-3MP, A/M 32A-95 and 502-70.

Navy - GTC-85, MA-1E, WELLS AIR START SYSTEM and RCPP/RCPT/NCPP-105.
8. Electrical units: (115/200 volts, 3-phase, 400-cycle required).

ALTERNATE FUELS

Alternate fuels can be used continuously with a possible loss of efficiency. The use of these fuels might result in increased maintenance. The use of JP-5 is limited to three consecutive flights after which fuel density adjustments must be accomplished for continued use. Any fuel used as an alternate fuel must contain an anti-icing inhibitor. If it does not, it must be used only in an emergency.

EMERGENCY FUELS

Emergency fuels may cause significant damage to the engine or other systems. Examples of conditions that might warrant use of emergency fuels are an accomplishment of an important mission and emergency evacuation flights.

a. Use of emergency fuels is restricted to a one time subsonic flight with minimum maneuvers and power changes. Engine RPM and EGT must be closely monitored to prevent exceeding operating limits during throttle movement. Rapid throttle movements and afterburner lights in flight are allowed only under emergency conditions.

b. Idle speed (minimum thrust) may be increased, acceleration may be faster causing the engine to stall, maximum RPM and EGT may be exceeded, and afterburner fuel flow may be high and cause the engine to stall.

c. When using fuel without an anti-icing inhibitor, flight is restricted to altitudes below the freezing level.

T.O. 1T-38C-1

FUEL SPECIFICATIONS		
GRADE DESIGNATION	FREEZE POINT °C	NATO SYMBOL
PRIMARY FUEL		
JP-8	-50	F-34
JET A with FSII	-40	NONE
JET A-1 with FSII	-50	F-34
JP-8+100	-50	F-37
ALTERNATE FUEL		
JP-4	-60	F-40
JET B	-50	NONE
*JP-5	-50	F-44
EMERGENCY FUELS		
JET A without FSII	-40	NONE
JET A-1 without FSII	-50	F-35
**AVGAS		
NOTE		
<p>When an alternate or emergency fuel is used, enter the fact in the aircraft AFTO Form 781.</p> <p>* The use of JP-5 is limited to three consecutive flights after which fuel density adjustments must be accomplished for continued use.</p> <p>** When aviation gasoline is used, a 3 % lubricating oil, specification MIL-L-22851, type II, must be added to improve its lubricity.</p>		

SECTION III

EMERGENCY PROCEDURES AND ABNORMAL OPERATIONS

TABLE OF CONTENTS	Page	Page
Warning/Caution/Advisory Displays	3-4	
Pilot Fault List	3-7	
GROUND EMERGENCIES		
Engine Fire During Start	3-17	
Excessive Hydraulic Pressure (Caution Light Off) (Ground)	3-17	
Departing Prepared Surface	3-17	
Emergency Ground Egress (BEFORE T.O. 1T-38C-546)	3-17	
Emergency Ground Egress (AFTER T.O. 1T-38C-546)	3-18	
Use of Canopy Breaker Tool	3-19	
TAKEOFF EMERGENCIES		
Abort	3-20	
Engine Failure/Fire Warning During Takeoff, Takeoff Continued	3-21	
Tire Failure During Takeoff, Takeoff Continued	3-22	
Barrier Engagement	3-22	
Landing Gear Retraction Failure	3-23	
HYDRAULIC EMERGENCIES		
Hydraulic Systems Malfunctions	3-24	
Hydraulic Malfunction (Caution Light(s) On)	3-24	
Excessive Hydraulic Pressure (Caution light Off) (In Flight)	3-25	
Gearbox Failure - Airframe Mounted	3-25	
ELECTRICAL EMERGENCIES		
Emergency Power Distribution	3-26	
Generator Failure (In Flight)	3-33	
Generator Failure (No AC Crossover)	3-33	
Generator Failure - Partial	3-34	
Gearbox Failure to Shift	3-34	
Dual Transformer-Rectifier Failure	3-34	
Electrical Fire	3-35	
Electrical Failure - Complete	3-35	
Right Essential 28 Volt DC Bus Failure ...	3-36	
Left Essential 28 Volt DC Bus Failure	3-36	
FUEL EMERGENCIES		
Fuel Quantity Indicator and Low-Level Caution Light System Malfunction	3-37	
Low Fuel Pressure/Fuel Leak	3-37	
OXYGEN EMERGENCIES		
Smoke, Fumes or Odors in Cockpit, In Flight	3-39	
Cabin Pressure Loss	3-39	
Oxygen System Emergency Operation	3-39	
ENGINE EMERGENCIES		
Single-Engine Flight Characteristics	3-40	
Fire Warning During Flight (Affected Engine)	3-40	
RPM Exceedance (Latched RPM) Engine)	3-41	
Engine Temperature Exceedance (Non Latched EGT)	3-41	
Engine Overtemperature (Latched EGT) ..	3-41	
Oil System Malfunction	3-41	
Nozzle Failure	3-41	
Engine Failure/Shutdown During Flight ..	3-42	
Restart During Flight	3-43	
Dual Engine Failure at Low Altitude	3-44	
Alternate Airstart/Loss of Thrust (Low Altitude)	3-44	
Compressor Stall	3-47	
FLIGHT CONTROL EMERGENCIES		
Abrupt and Uncommanded Aircraft Pitch-Up, Flaps Extended	3-48	
Uncommanded Smooth Pitch-Up Dur- ing Flap Extension	3-48	
Flap Asymmetry	3-49	
Flap Horizontal Tail Linkage Malfunction	3-50	
Trim Malfunction	3-50	
Stability Augmentor Malfunction	3-51	
Rudder System Malfunctions	3-51	
Controllability Check/Structural Damage.	3-52	

T.O. 1T-38C-1

	Page	NOTE	
MISCELLANEOUS EMERGENCIES			
Brake System Malfunction (Fluid Venting)	3-54	<ul style="list-style-type: none"> • A critical procedure is an emergency procedure that must be performed immediately without reference to printed checklist and that must be committed to memory. These critical procedures appear in BOLDFACE capital letters. Noncritical procedures are all other steps wherein there is time available to consult the checklist. • In the event of multiple emergencies, the pilot is required to exercise sound judgement as to the appropriate action. A thorough knowledge of the correct procedures and aircraft systems is essential to analyze the situation correctly and determine the best course of action. • To assist the pilot when an emergency occurs, three basic rules are established that apply to most emergencies occurring while airborne. They should be remembered by each aircrew member. <ol style="list-style-type: none"> 1. Maintain aircraft control. 2. Analyze the situation and take proper action. 3. Land as soon as conditions permit. 	
Ejection vs Forced Landing	3-54		
Ditching	3-54		
Ejection Procedure (BEFORE T.O. 1T-38C-546)	3-54		
Ejection Procedure (AFTER T.O. 1T-38C-546)	3-62		
Loss of Canopy	3-71		
Smoke, Fumes or Odors in Cockpit (Ground)	3-71		
Throttle Binding.....	3-71		
Pitot Static System Malfunction	3-72		
LANDING EMERGENCIES			
Landing Gear Extension Failure.....	3-73		
Landing Gear Alternate Extension.....	3-73		
Landing With All Gear Up	3-75		
Landing With Nose Gear Up/Unsafe	3-75		
No Flap Landing	3-76		
Single-Engine Approaches	3-76		
Single-Engine Missed Approach	3-76		
Single-Engine Go-Around	3-76		
Single-Engine Landing	3-77		
Landing With Blown Tire, Locked Brake or Directional Control Difficulty.....	3-82		
AVIONICS MALFUNCTIONS			
EED Internal Failure.....	3-83		
EED Sensor Failure	3-83		
EED Internal BIT Failure	3-83		
EED Hot	3-83		
EGI Failure - GPS	3-83		
EGI Failure - INS	3-84		
EGI Failure - TOTAL	3-84		
HUD and/or UFCP Failure	3-87		
MFD Failure	3-87		
Main Audio Mode Failure.....	3-87		
MDP Degraded.....	3-87		
MDP Failure	3-89		
MDP Reboot	3-89		
NAV Failure.....	3-89		
NAV Failure To Tune	3-90		
VOR/ILS/TACAN Failure	3-90		
TCAS (IFF) Failure	3-90		
UHF Degraded.....	3-90		
UHF Total Failure	3-90		
VHF Total Failure	3-90		
OTHER EMERGENCIES			
Emergency Entrance.....	3-91		

Land as Soon as Possible

An emergency will be declared. A landing should be accomplished at the nearest suitable airfield considering the severity of the emergency, weather conditions, field facilities, ambient lighting, aircraft gross weight, and command guidance.

Land as Soon as Practical

Emergency conditions are less urgent, and although the mission is to be terminated, the degree of the emergency is such that an immediate landing at the nearest adequate airfield may not be necessary.

WARNING/CAUTION/ADVISORY DISPLAYS

Warning/Caution/Advisory Displays are listed in Figure 3-1, together with their cause(s) and corrective action(s) or references. They are listed under three major headings:

- a. Warning lights/messages
- b. Caution displays
- c. Advisory displays

Each display is listed alphabetically under its major heading; however, if the display starts with a single letter (or left or right) that letter (word) is not used to place the display alphabetically.

Do not use this table as the sole source for deciding a course of action in the event a warning, caution or

advisory appears. Review other aircraft and instrument indications before responding.

PILOT FAULT LIST

The Pilot Fault List (PFL) is shown in Figure 3-2. Each item is listed alphabetically under its major system together with the cause(s) and corrective action(s) or references.

Do not use this table as the sole source for deciding a course of action in the event a PFL item appears. Review other aircraft and instrument indications before responding.

T.O. 1T-38C-1

INDICATOR	CAUSE/REMARKS	CORRECTIVE ACTION
RED WARNING LIGHTS		
ALTITUDE	Altitude below minimum altitude set on UFCP ALT Key Display	Climb above minimum altitude set on UFCP display or set lower altitude.
FIRE	Engine fire detected	Refer to FIRE WARNING DURING FLIGHT (AFFECTED ENGINE), page 3-40, ENGINE FIRE DURING START, page 3-17, this section.
GEAR	1. Landing gear not down and locked with: <ol style="list-style-type: none"> a. Decelerating airspeed 210 KCAS or less b. Altitude below 10,000 feet. c. Both throttles below 96 % RPM. 2. Landing gear handle up and doors not closed 3. Landing gear handle down and gear not down and locked.	Increase airspeed (above 240 KCAS), altitude or throttle setting; or lower landing gear (if appropriate). Refer to LANDING GEAR RETRACTION FAILURE, page 3-23, this section. Refer to LANDING GEAR EXTENSION FAILURE, page 3-72, this section.
STALL	Landing gear extended and AOA at or above 0.80	Recover from stall by reducing AOA.
CANOPY	Canopy not fully closed and locked	Ground Close and lock canopy. In Flight Land as soon as practical.
YELLOW CAUTION LIGHTS (Caution Light Panel)		
ENG ANTI-ICE ON	ENG ANTI-ICE Switch is in MAN ON position	Information
LEFT FUEL PRESS RIGHT FUEL PRESS	<ul style="list-style-type: none"> • Low fuel pressure • Loss of boost pump NOTE Reset boost pump circuit breaker only one time. <ul style="list-style-type: none"> • Fuel leak • Fuel line leak • Generator phase failure • Surging of engine driven pump 	Refer to LOW FUEL PRESSURE/FUEL LEAK, page 3-37, this section.
FUEL LOW	Either fuel quantity indicator reads <250 pounds for 7.5 seconds	Check left and right fuel quantity indicators to determine which system is low.

Figure 3-1. Warning/Caution/Advisory Displays (Sheet 1 of 3)

3-4

INDICATOR	CAUSE/REMARKS	CORRECTIVE ACTION
YELLOW CAUTION LIGHTS (Caution Light Panel) (Continued)		
LEFT GENERATOR RIGHT GENERATOR	<ul style="list-style-type: none"> • Designated generator off line • Either generator can support the total aircraft electrical load 	Refer to GENERATOR FAILURE (In Flight), page 3-33, GENERATOR FAILURE (No AC Crossover), page 3-33, GENERATOR FAILURE - PARTIAL, page 3-34, GEARBOX FAILURE TO SHIFT, page 3-34, this section.
FLIGHT HYDRAULIC UTILITY HYDRAULIC	Hydraulic system <ul style="list-style-type: none"> • Fluid overtemperature • Low pressure 	Refer to HYDRAULIC MALFUNCTION (CAUTION LIGHT (S) ON), page 3-24, this section.
OXYGEN	<ul style="list-style-type: none"> • Oxygen indicator reads 1 liter or less of liquid oxygen • Light may blink due to oxygen sloshing if system contains less than 3 liters 	Information
XMFR RECT OUT	<ul style="list-style-type: none"> • Failure of both transformer-rectifiers • DC powered systems supplied by aircraft battery 	Refer to DUAL TRANSFORMER-RECTIFIER FAILURE, page 3-34, this section.
ADVISORIES		
AVIONICS	Failure of avionics system listed on Pilot Fault List	<ul style="list-style-type: none"> • Information • Check affected system.
BINGO	Fuel below Bingo bug setting	<ul style="list-style-type: none"> • Information • Check fuel quantity and Bingo bug setting.
CAUTION	MASTER CAUTION light is on	Correct problem causing MASTER CAUTION light illumination.

Figure 3-1. Warning/Caution/Advisory Displays (Sheet 2)

T.O. 1T-38C-1

INDICATOR	CAUSE/REMARKS	CORRECTIVE ACTION
ADVISORIES (Continued)		
ENGINE	<ul style="list-style-type: none"> • Left/right RPM exceedance • Left/right oil pressure high or low caution • Latched left/right EGT overtemp • Latched left/right oil pressure high or low • Engine sensor failure 	Refer to EED to determine cause. If RPM exceedance - Refer to RPM EXCEEDANCE (LATCHED RPM), page 3-41, this section. If oil pressure high or low caution - Refer to OIL SYSTEM MALFUNCTION, page 3-41, this section. If EGT overtemp - Refer to ENGINE OVERTEMPERATURE (LATCHED EGT), page 3-41, this section. If latched oil pressure high or low - Refer to OIL SYSTEM MALFUNCTION, page 3-41, this section. If engine sensor failure - Refer to EED SENSOR FAILURE, page 3-82, this section.
OVER G	Aircraft G load value exceeded 100 % of Max G limit	Information

Figure 3-1. Warning/Caution/Advisory Displays (Sheet 3)

3-6

INDICATION	CAUSE/REMARKS	CORRECTIVE ACTION
AIR DATA COMPUTER (ADC)		
ADC FAILURE	<ul style="list-style-type: none"> • ADC status failure • Memory failure 	Refer to PITOT STATIC SYSTEM MALFUNCTION, page 3-70, this section.
ANTENNA		
TCAS LOWER ANTENNA FAILURE TCAS UNAVAILABLE	Lower antenna failure/TCAS unavailable	Refer to TCAS (IFF) FAILURE, page 3-89, this section.
TCAS UPPER ANTENNA FAILURE TCAS UNAVAILABLE	Upper antenna failure/TCAS unavailable	
AUDIO SYSTEM (AIU)		
AUDIO BACK-UP MODE	Switching to B/U on ACP in either cockpit	Information
MAIN AUDIO MODE FAILURE	AIU Fail	Refer to MAIN AUDIO MODE FAILURE, page 3-86, this section.
DME		
FAILED TO TUNE	DME channel of the TACAN system (transceiver D) failed to tune correctly	<ul style="list-style-type: none"> • Cycle power on the TACAN and VOR/ILS. • TACAN transceiver A is tuned to the desired DME channel via the UFCP. • Use the TCN range window on MFD.
DTS		
CARTRIDGE FAILURE	Cartridge failure	<ul style="list-style-type: none"> • Eject and reinsert DTC into the DTD. • Reformat cartridge or use another cartridge.
CARTRIDGE REMOVED DURING DATA TRANSFER	DTC was ejected while ACMI/Flight Loads Data recording in progress	Reinsert the DTC.
TOTAL FAILURE	DTS internal failure	Information

Figure 3-2 . Pilot Fault List (Sheet 1 of 10)

T.O. 1T-38C-1

INDICATION	CAUSE/REMARKS	CORRECTIVE ACTION
EED		
AFT COOLING FAN FAILURE	<ul style="list-style-type: none"> • Fan Failure, EED display may over-heat • EED continues to display data until an EED HOT PFL is generated 	Ground Abort mission. In Flight No action required unless an EED HOT PFL is generated.
AFT EED FAILURE	RCP EED internal failure	Refer to EED INTERNAL BIT FAILURE, page 3-82, this section.
AFT EED HOT	RCP EED display dims 50 % if in DAY mode and EED HOT is displayed. If the hot condition persists, the EED display blanks 1 minute after PFL is generated. Engine data continues to be reliable. NOTE Display does not dim 50 % if in NIGHT mode.	Refer to EED HOT, page 3-82 , this section.
AFT EED SLAVE MODE NOT AVAILABLE	<ul style="list-style-type: none"> • RCP EED ARINC receiver failure • Gauge data continues to be reliable 	Ground - Abort mission. In Flight - Use RCP EED as Master.
AFT EGT FAILURE	RCP EED internal failure, making L/R gauge data unreliable	Refer to EED INTERNAL FAILURE, page 3-82, this section.
AFT FF FAILURE		
AFT FUEL FAILURE		
AFT NOZ FAILURE		
AFT OIL FAILURE		
AFT RPM FAILURE		
FWD COOLING FAN FAILURE	<ul style="list-style-type: none"> • Fan Failure, EED display may over-heat • EED continues to display data until an EED HOT PFL is generated 	Ground - Abort mission. In Flight - No action required unless an EED HOT PFL is generated.
FWD EED FAILURE	FCP EED internal failure	Refer to EED INTERNAL BIT FAILURE, page 3-82, this section.

Figure 3-2 . Pilot Fault List (Sheet 2)

INDICATION	CAUSE/REMARKS	CORRECTIVE ACTION
EED (Continued)		
FWD EED HOT	FCP EED display dims 50 % if in DAY mode and EED HOT is displayed. If the hot condition persists, the EED display blanks 1 minute after PFL is generated. Engine data continues to be reliable. NOTE Display does not dim 50 % if in night mode.	Refer to EED HOT, page 3-82, this section.
FWD EED SLAVE MODE NOT AVAILABLE	<ul style="list-style-type: none"> • FCP EED ARINC receiver failure • Gauge data continues to be reliable 	Ground - Abort mission. In Flight - Use FCP EED as Master.
FWD EGT FAILURE	FCP EED internal failure making L/R gauge data unreliable	Refer to EED INTERNAL FAILURE, page 3-82, this section.
FWD FF FAILURE		
FWD FUEL FAILURE		
FWD NOZ FAILURE		
FWD OIL FAILURE		
FWD RPM FAILURE		
EGI		
EGI ALIGNMENT TIME MAY EXCEED 4 MIN VERIFY CORRECT DEST 200 POSITION	Power removed from EGI before time for proper shutdown (10 sec) may have corrupted various alignment parameters	Verify present position coordinates are correct (to include proper E/W hemisphere). If they are correct, EGI will align correctly. If not, this PFL can be cleared by cycling power on EGI and entering correct coordinates to realign EGI.
GPS FAILURE	<ul style="list-style-type: none"> • GPS fault • The EGI mode does not change; however, the blended solution EGI is based solely on INS 	Refer to EGI FAILURE - GPS, page 3-82, this section.
INERTIAL REFERENCE FAILURE - NAV AND ATT NOT RELIABLE	INS failure	Refer to EGI FAILURE - INS, page 3-83, this section.

Figure 3-2 . Pilot Fault List (Sheet 3)

T.O. 1T-38C-1

INDICATION	CAUSE/REMARKS	CORRECTIVE ACTION
EGI (Continued)		
INS ALIGNMENT ERROR ENTER CORRECT DEST 200 LATITUDE	INS not aligning correctly due to incorrect latitude in the present position	Cycle power on the EGI and enter correct DEST 200 latitude (if not corrected by EGI already).
INS NAV DEGRADED GPS OK	EGI blended solution unreliable - INS and GPS solution diverging	GPS only solution can be used but due to a slower update rate and possible display ratcheting, GPS only should not be used for approach.
GPS INTEGRITY FAILURE	RAIM alarm	EGI should not be used as a primary navigation source.
GPS INTEGRITY CHECK UNAVAILABLE	RAIM check not available	
GPS APPROACH NOT AVAILABLE LIMITED SATELLITE AVAILABILITY	Negative PRAIM results	GPS approach not available
INS NAVIGATION ACCURACY DEGRADED	<ul style="list-style-type: none"> • (EGI) NAV mode selected before full alignment completed • GPS failure to acquire satellites 	<p>If full alignment not required- Information</p> <p>If full alignment required- Refer to EGI FAILURE - INS, page 3-83, this section.</p> <p>If taxiing - Stop taxiing. Continue alignment by toggling NAV to ALN on UFCP EGI menu.</p> <p>If parked - Continue alignment by toggling NAV to ALN on UFCP EGI menu.</p>
RALT FAILURE	Radar altimeter failure	UFCP EGI NAV function display - RALT - OFF, THEN ON (Recycle RALT OSB.)
SUBSYSTEM FAIL	EGI total failure	Refer to EGI FAILURE - TOTAL, page 3-83, this section.

Figure 3-2 . Pilot Fault List (Sheet 4)

INDICATION	CAUSE/REMARKS	CORRECTIVE ACTION
ENGINE		
EGT OVERTEMP	Left or right engine overtemperature	Refer to ENGINE OVERTEMPERATURE (LATCHED EGT), page 3-41, this section.
NOZ SENSOR FAILURE	L/R nozzle position sensor signal not detected by EED	Refer to EED SENSOR FAILURE, page 3-82, this section.
OIL SENSOR FAILURE	L/R oil pressure sensor signal not detected by EED	
FF SENSOR FAILURE	L/R fuel flow sensor signal not detected by EED	
FUEL SENSOR FAILURE	L/R fuel quantity sensor signal not detected by EED	
OIL PRESSURE HIGH	L/R oil pressure high	Refer to OIL SYSTEM MALFUNCTION, page 3-41 this section.
OIL PRESSURE LOW	L/R oil pressure low	
HUD		
DISPLAY UNIT FAILURE	<ul style="list-style-type: none"> • HUD power supply failure • Fwd UFCP failure 	Refer to HUD AND/OR UFCP FAILURE, page 3-86, this section.
MDP		
ADC ARINC FAILURE	<ul style="list-style-type: none"> • MDP internal failure on the ADC ARINC channel • ADC data (BARO altitude, air speed, AOA) not available or unreliable 	Cycle power on MDP. If condition persists, land as soon as possible.
AFT EED ARINC FAILURE	<ul style="list-style-type: none"> • MDP internal failure on the RCP EED ARINC channel • RCP EED data unavailable 	Set FCP EED to Master.
AFT VIDEO FAIL	<ul style="list-style-type: none"> • No RCP VIDEO from MDP • RCP MFD switches to backup mode 	Information
ARINC TOTAL FAILURE	<ul style="list-style-type: none"> • MDP internal ARINC total failure • Loss of all ARINC communication 	Cycle power on MDP. If condition persists, land as soon as possible. Select NAV B/U on AAP.

Figure 3-2 . Pilot Fault List (Sheet 5)

T.O. 1T-38C-1

INDICATION	CAUSE/REMARKS	CORRECTIVE ACTION
MDP (Continued)		
AURAL WARNING INTERFACE FAILURE	Aural warnings may be inaccurate	Information. If necessary, select B/U on ACP. Continue the mission.
BACK MFD IMAGE FAILURE	MFD may switch to backup mode	Information
BACK MFD VIDEO FAILURE		
DATA RECORDING FAILURE	<ul style="list-style-type: none"> • MDP memory failure • MDP communication failure • May lose stored data (presets) 	Consider terminating mission. Refer to MDP FAILURE, page 3-88, this section.
FRONT MFD IMAGE FAILURE	MFD may switch to backup mode	Information
FRONT MFD VIDEO FAILURE		
FWD EED ARINC FAILURE	<ul style="list-style-type: none"> • MDP internal failure on the FCP EED ARINC channel after warm start • FCP EED data unavailable to MDP 	Set RCP EED to Master.
FWD VIDEO FAIL	<ul style="list-style-type: none"> • No FCP VIDEO from MDP • FCP MFD switches to backup mode 	Information
HUD DISPLAY FAILURE	Poor/missing video display	Refer to HUD AND/OR UFCP Failure, page 3-86
HUD VIDEO FAILURE	No HUD video after MDP automatic warm start to correct the problem	Refer to HUD AND/OR UFCP Failure, page 3-86
MDP FAILURE	<ul style="list-style-type: none"> • MDP memory failure • MDP communication failure • May lose stored data (presets) • Possible MDP failure 	Consider terminating mission. Refer to MDP FAILURE, page 3-88, this section.
MDP INTERFACE FAILURE	MDP communication failure	Refer to MDP DEGRADED, page 3-86, this section.

Figure 3-2 . Pilot Fault List (Sheet 6)

INDICATION	CAUSE/REMARKS	CORRECTIVE ACTION
MDP (Continued)		
MDP PS FAILURE	Power supply test failure	Ground - Cycle MDP power. If problem persists, abort mission.
MDP PUB FAILURE	MDP Power up BIT failure	In Flight - Land as soon as practical.
NO CONTROL FOR COMM, VID, TCAS, NO COMM WITH ADC	MFD display (other than attitude data) may be inaccurate	<ul style="list-style-type: none"> • Use backup instruments. • Land as soon as practical.
NO HUD ON BACK MFD	<ul style="list-style-type: none"> • MDP internal failure • HUD video not available on RCP MFD 	Information
NO HUD ON FRONT MFD	<ul style="list-style-type: none"> • MDP internal failure • HUD video not available on FCP MFD 	
TACAN ARINC FAILURE	<ul style="list-style-type: none"> • MDP internal failure on TACAN ARINC channel after warm start • TACAN bearing and range not available or not reliable or TACAN fails to tune 	Select NAV B/U on AAP to manually tune TACAN.
TCAS ARINC FAILURE	<ul style="list-style-type: none"> • MDP internal failure on TCAS ARINC channel after warm start • TCAS data not available or not reliable 	Information
UHF ARINC FAILURE	MDP internal failure on UHF ARINC channel after warm start	Select UHF B/U on AAP to manually tune UHF.
VHF ARINC FAILURE	MDP internal failure on VHF ARINC channel after warm start	Information
VIDEO FAILURE AFT MFD IN BACKUP	Possible RCP MFD display malfunction	Information
VIDEO FAILURE FWD MFD IN BACKUP	Possible FCP MFD display malfunction	Information
VOR ARINC FAILURE	<ul style="list-style-type: none"> • MDP internal failure on VOR ARINC channel after warm start • VOR bearing and range not available or not reliable or VOR fails to tune 	Select NAV B/U on AAP to manually tune VOR.

Figure 3-2 . Pilot Fault List (Sheet 7)

T.O. 1T-38C-1

INDICATION	CAUSE/REMARKS	CORRECTIVE ACTION
MFD		
AFT OVERTEMP	RCP MFD display is overheated. If condition persists the display goes blank 1 minute after PFL is generated	Cross check instruments and land as soon as practical. Leave display on so that it recovers if the condition goes away.
AFT BACKUP DEGRADED	<ul style="list-style-type: none"> • Internal RCP MFD ARINC failure • No communication on backup ARINC • No MDP backup on RCP MFD 	Information
AFT COOLING FAN FAILURE	<ul style="list-style-type: none"> • RCP MFD fan failure • RCP MFD display may overheat 	If the display overheats then an AFT OVERTEMP PFL is generated. Refer to AFT OVERTEMP PFL, this page.
FWD BACKUP DEGRADED	<ul style="list-style-type: none"> • Internal FCP MFD ARINC failure • No communication on backup ARINC • No MDP backup on FCP MFD 	Information
FWD COOLING FAN FAILURE	<ul style="list-style-type: none"> • FCP MFD fan failure • FCP MFD display may overheat 	If the display overheats a FWD OVERTEMP PFL is generated. Refer to FWD OVERTEMP PFL, this page.
FWD OVERTEMP	FCP MFD display is overheated. If condition persists, the display goes blank 1 minute after PFL is generated.	Cross check instruments and land as soon as practical. Leave display on so that it recovers if the condition goes away.
PSU		
HUD POWER SUPPLY FAILURE	<ul style="list-style-type: none"> • HUD PSU failure • Aircraft wiring 	Refer to HUD AND/OR UFCP FAILURE, page 3-86, this section.
UFCP POWER SUPPLY FAILURE	<ul style="list-style-type: none"> • UFCP PSU failure • Aircraft wiring 	
TCAS		
TCAS FAILURE TRANSPONDER – OK	<ul style="list-style-type: none"> • TCAS processor failure • T1 Bus from TCAS to MDP • TCAS input data failure 	Refer to TCAS (IFF) FAILURE, page 3-89, this section.
TCAS NOT AVAILABLE TRANSPONDER – OK	Insufficient data for TCAS display	

Figure 3-2 . Pilot Fault List (Sheet 8)

INDICATION	CAUSE/REMARKS	CORRECTIVE ACTION
TCN		
FAILED TO TUNE	TACAN frequency failed to tune correctly	<ul style="list-style-type: none"> • Cycle power switch on TACAN control panel. • If conditions persist, select NAV B/U on AAP.
NO RESPONSE FROM LOGIC PCB	TACAN powerup BIT failure	<ul style="list-style-type: none"> • Cycle power switch on TACAN control panel. • Select NAV B/U on AAP.
RAM AND ROM FAILURE		
RAM FAILURE		
ROM FAILURE		
TRU		
RECTIFIER FAILURE	At least one TRU failed (XMFR RECT OUT light not illuminated)	Ground - Abort sortie. In Flight - Land as soon as practical.
UFCP		
AFT UFCP FAILURE	UFCP LRU failure	Refer to HUD AND/OR UFCP FAILURE, page 3-86, this section.
FWD UFCP FAILURE		
PARTIAL FAILURE IN AFT KEYBOARD	Keyboard failure	Information
PARTIAL FAILURE IN FWD KEYBOARD		
UHF		
UHF TOTAL FAILURE	Synthesizer out-of-lock status	Refer to UHF TOTAL FAILURE, page 3-89, this section.
VHF		
VHF TOTAL FAILURE	Frequency synthesizer lock failure	Refer to VHF TOTAL FAILURE, page 3-89, this section.

Figure 3-2 . Pilot Fault List (Sheet 9)

T.O. 1T-38C-1

INDICATION	CAUSE/REMARKS	CORRECTIVE ACTION
VOR		
FAILED TO TUNE	VOR frequency failed to tune correctly	Select NAV B/U on AAP.
XPDR		
TCAS FAILURE TRANSPONDER - OK	TCAS input data failure	Refer to TCAS (IFF) FAILURE, page 3-89, this section.
TRANSPONDER FAILURE TCAS UNAVAILABLE	Mode S transponder failure	
TRANSPONDER MODE C AND TCAS UNAVAILABLE	TCAS not available due to invalid baro altitude input from ADC	
TRANSPONDER MODE C FAILURE TCAS UNAVAILABLE	<ul style="list-style-type: none"> • Transponder does not report altitude • Altitude input No. 1 	
YSAS		
FAILED TO ENGAGE SAS SWITCH	YSAS not engaged within time limits during YSAS IBIT	Information
PROCEDURAL DISEN- GAGEMENT	YSAS disengagement due to incorrect operator procedure	
SAS FAILURE	YSAS system failure	Refer to STABILITY AUGMENTOR MALFUNCTION, page 3-50, this section.

Figure 3-2 . Pilot Fault List (Sheet 10)

GROUND EMERGENCIES

ENGINE FIRE DURING START

If a fire light comes on, or if there are other indications of a fire, proceed as follows:

1. Throttles - OFF
2. BATTERY/APU - OFF

NOTE

Time and conditions permitting, alert the ground controlling agency and the other crew member of egress intentions prior to shutting the battery/APU off.

EXCESSIVE HYDRAULIC PRESSURE (CAUTION LIGHT OFF) (GROUND)

NOTE

Cycling the flight controls once may reduce indicated hydraulic pressure indication if air has been introduced into the respective hydraulic system during servicing.

1. Throttle gate - DISENGAGE
2. Affected engine - SHUT DOWN

DEPARTING PREPARED SURFACE

Any time the aircraft departs a hard surface (taxiway or runway), immediately shut down both engines. Refer to EMERGENCY GROUND EGRESS to abandon the aircraft.

EMERGENCY GROUND EGRESS (BEFORE T.O. 1T-38C-546)

When a situation develops which requires a crewmember to abandon the aircraft, disengage the throttle gate, place the throttles at OFF, BATTERY switch at OFF, insert the ejection seat safety pin, release the survival kit, if one is carried, by pulling the survival kit emergency release handle (Figure 1-37),

disconnect personal leads and release safety belt. Crewmembers should consider removing the parachute when disconnecting equipment to facilitate exit from the cockpit. Open the canopy. If either canopy cannot be opened by the normal procedure, pull the canopy jettison T-handle. If either canopy fails to open or jettison, break through the canopy using the canopy breaker tool (Figure 3-3).

Emergency egress on the ground as follows:

1. Throttle gate - DISENGAGE
2. Throttles - OFF
3. Notify crewmember of decision to ground egress, as required.
4. BATTERY switch - OFF
5. Ejection seat safety pin - INSERT

WARNING

Inadvertently raising the ejection seat handgrip instead of survival kit emergency release handle will cause ejection.

6. Survival kit - RELEASE (IF CARRIED)

WARNING

To avoid kit deployment during ground egress, survival kit must be seated firmly before survival kit emergency release handle is pulled.

7. Personal leads and safety belt - RELEASE
8. Canopy - OPEN

CAUTION

Canopy seals will remain inflated if engines are shut down with both canopies locked, making canopies more difficult to open.

9. Cockpit - EXIT

T.O. 1T-38C-1

**EMERGENCY GROUND EGRESS
(AFTER T.O. 1T-38C-546)**

If a situation develops which requires a crewmember to abandon the aircraft, disengage the throttle gate, place the throttles at OFF, BATTERY switch at OFF, move the SAFE/ARMED handle to the SAFE position, disconnect the torso harness parachute release fittings, lap strap connectors, survival kit LH/RH torso harness quick release connectors, and upper and lower leg garter quick release connectors. Open the canopy by normal procedures or pull the jettison T-handle if required. Stand to disconnect personal leads. If either canopy fails to open or jettison, break through the canopy using the canopy breaker tool (Figure 3-3).

WARNING

- Make sure there is sufficient time to execute an egress on the ground. Once emergency ground egress has been initiated, ejection can cause injury or death.
- Ejection sequence initiation underneath a shelter will cause injury or death.
- To avoid inadvertant ejection, do not stand on ejection or manual override handles.

NOTE

In a situation requiring immediate ground egress, the ejection system has the capability for zero altitude/zero airspeed ejection.

Emergency egress on the ground as follows:

1. Throttle gate - DISENGAGE
2. Throttles - OFF
3. Notify crewmember of decision to ground egress, as required.
4. BATTERY switch - OFF
5. Ejection handle safety pin - INSERT
6. SAFE/ARMED handle - SAFE (BOTH)
7. Torso harness parachute release fittings - DISCONNECT
8. Lap strap connector - DISCONNECT
9. SSK torso harness LH/RH attachment strap quick release connectors - DISCONNECT
10. Visor(s) - DOWN
11. Upper and lower leg garter quick release connectors - PUSH IN BOTH PLUNGERS AND REMOVE
12. Canopy - OPEN (NORMAL/JETTISON, AS REQUIRED)
13. Aircrew ejection seat connections - STAND TO DISCONNECT
14. Cockpit - EXIT

USE OF CANOPY BREAKER TOOL

To break the canopy, grasp the canopy breaker tool, Figure 3-3, with both hands and use your body weight behind an arm swinging thrust. Aim the point of the tool to strike perpendicular to the canopy surface. The blade alignment will determine the direction of the cracks. No set pattern of blows is necessary on the front canopy. Several minutes of chopping may be required to open an adequate hole in the rear canopy.

WARNING

To preclude personal injury, the curved edge of the blade must be towards you. This will allow glancing blows against the canopy to deflect away from you.

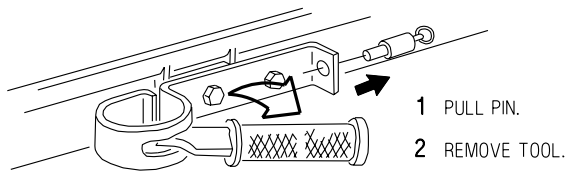
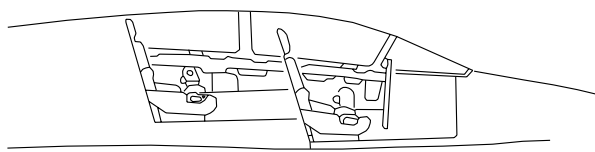

3 USE BOTH HANDS ON HANDLE TO BREAK CANOPY WITH POINT OF TOOL.

T38002-16-1-020

Figure 3-3. Canopy Breaker Tool

TAKEOFF EMERGENCIES

ABORT

If the decision is made to abort during a takeoff or touch-and-go-landing, such variables as gross weight, pressure altitude, runway condition (i.e., dry, wet, icy) and runway length must be evaluated.

The braking energy required during a high speed, heavy gross weight abort may result in brake failure, a significant decrease in braking effectiveness, hot brakes or tire failure/fire. An aborted takeoff with tire failure presents a greater problem than landing with a failed tire. The effects of a tire failure are most pronounced at heavy gross weights and speeds below 100 KCAS. Directional control is more difficult and braking effectiveness is greatly reduced at higher gross weights.

Aerodynamic braking is more effective than cautious wheel braking above 100 KCAS and it avoids the potential for skidding, blown tires, brake failure, etc. Use aerodynamic braking to the maximum extent possible during any abort above 100 KCAS. Once the nosewheel returns to the runway, initiate a smooth brake application with the stick full aft, increasing brake pressure as the airspeed decreases. Unless brake failure occurs, avoid pumping the brakes.

During heavy gross weight aborts, the nose will lower at approximately 120 KCAS. When the nosewheel is lowered to the runway, immediately commence moderate braking while maintaining full aft stick. Optimum braking should not be attempted in excess of 100 KCAS. Aerodynamic braking performed with less than full flaps or a 12° pitch attitude becomes progressively less effective. Aerobraking is recommended even if it is not possible to obtain this optimum configuration and pitch attitude. If runway length is insufficient to completely stop the aircraft, decelerate as much as possible and prepare to engage the barrier or depart the hard surface.

1. THROTTLES - IDLE

2. WHEEL BRAKES - AS REQUIRED

WARNING

- Braking required for high speed, heavy gross weight aborts may result in extremely hot brakes or brake failure and possibility of tire fire should be anticipated.
- If hot brakes are suspected, the aircraft should not be taxied into a congested area. Ensure all personnel remain clear of the main wheels until they have cooled. Comply with local hot brakes procedures/directives.

CAUTION

- During high speed abort situations, it is essential maximum aerodynamic braking be attained. Once established in an aerobrake, lowering flaps will further reduce the stopping distance. Flaps should not be repositioned until the full aft stick pitch attitude is attained. The aircraft may become airborne if flaps are lowered above the computed full flap touchdown speed.
- Heavy braking above 100 KCAS may cause skidding, tire failure, and loss of directional control.
- Cautious braking must be exercised when applying wheel brakes between 100-130 KCAS as locked wheels or tire skids are difficult to recognize. If tire skid is detected, immediately release both brakes and cautiously reapply.
- If possible, optimum braking should be used below 100 KCAS to reduce braking distance.

NOTE

- If the abort was made as a result of an engine fire, place the throttle of the

affected engine to OFF once the aircraft is under control. If the fire is confirmed, accomplish the EMERGENCY GROUND EGRESS procedures once the aircraft is stopped.

- An aborted takeoff with tire failure will present a greater problem than landing with a failed tire. The effects of a tire failure are most pronounced at heavy gross weights and speeds below 100 KCAS. Directional control is more difficult and braking effectiveness is greatly reduced at higher gross weights.

ENGINE FAILURE/FIRE WARNING DURING TAKEOFF, TAKEOFF CONTINUED

If an engine fails on takeoff prior to reaching decision speed, use the ABORT and BARRIER ENGAGEMENT procedures in this section. If an engine fails on takeoff above the computed decision speed, it is possible to continue the takeoff. Limited excess thrust is available for takeoff, acceleration and climb-out when operating on a single engine. The available runway should be used to accelerate the aircraft above Single-Engine Takeoff Speed (SETOS). The computed SETOS is the minimum speed at which the aircraft will take off and be able to fly out of ground effect with a minimum of 100 FPM rate of climb. Takeoff and landing data (TOLD) can be verified only by an accurate acceleration speed check. A significant relationship exist between airspeed and initial climb performance: between SETOS and SETOS + 10 KCAS, single-climb performance increases at the rate of 8-50 FPM for each knot of airspeed above SETOS (depending on temperature/pressure altitude). Best acceleration occurs with the aircraft in a three-point attitude, with the stick at or slightly aft of the takeoff trim setting. The nosewheel should not be allowed to dig-in, nor should it be permitted to lift off. This attitude must be maintained until the airspeed reaches a minimum of SETOS. Initial pitch attitude is shallower than normal. Climb should be restricted to only that required to avoid obstacles until the airspeed reaches 200 KCAS and flaps are retracted. The gear should be retracted as soon as the aircraft is airborne above SETOS +10 KCAS. Gear door drag is not a factor during retraction above SETOS +10 KCAS. The flaps should be raised after gear retraction and above 200 KCAS.

Due to the critical nature of airspeed and altitude and the ejection envelope, the decision made by the pilot may vary.

1. THROTTLES - MAX

WARNING

Continuing a takeoff on a single-engine should be attempted only at maximum thrust.

NOTE

Depending on airspeed and altitude, it may be necessary to leave the throttle of the affected engine at a high power setting until reaching a safe airspeed and/or altitude for ejection.

2. FLAPS - 60 %

WARNING

With other than 60 % flaps, single-engine capability is impaired to such an extent that the combination of temperature, pressure altitude and gross weight may make takeoff impossible.

NOTE

After flaps are set at 60 % the flap indicator should be checked to ensure flaps are within 60 % range (55-65 %).

T.O. 1T-38C-1

3. AIRSPEED - ATTAIN SETOS MINIMUM.

WARNING

If engine failure occurs after rotation, it will probably be necessary to lower the nose to attain speed above SETOS. If engine failure occurs after takeoff, it may be necessary to allow the aircraft to settle back to the runway.

CAUTION

The nosewheel tire limit may be exceeded prior to reaching SETOS +10 KCAS.

4. Gear - UP (WHEN AIRBORNE ABOVE SETOS + 10 KCAS)

NOTE

- If the left engine is inoperative but windmilling, gear retraction may be accomplished but will require an extended time period; however, gear doors may not completely close. Gear retraction, when initiated between SETOS +10 KCAS and 200 KCAS, may require up to 1 minute.
- If unable to retract the landing gear, best level flight/climb capability is obtained at 200 KCAS with 60% flaps or at 220 KCAS with the flaps up. At high gross weight with the landing gear extended, flap retraction should not be initiated prior to 220 KCAS.

5. Flaps - UP (AS REQUIRED ABOVE 200 KCAS)

TIRE FAILURE DURING TAKEOFF, TAKEOFF CONTINUED

A takeoff abort with tire failure will present a greater problem than landing with a failed tire. The effects of a tire failure are most pronounced at heavy gross weights and speeds below 100 KCAS. Directional control is more difficult and braking effectiveness is greatly reduced at higher gross weights.

1. GEAR - DO NOT RETRACT

If possible, reduce fuel weight prior to landing. Land on side of runway away from blown tire and make maximum use of rudder and wheel braking to maintain directional control. Nosewheel steering is engaged as a final attempt to maintain or regain directional control. Ensure rudder pedals are neutralized prior to engaging nosewheel steering. Once aircraft is stopped, do not clear the runway, change configuration, or activate flight controls.

BARRIER ENGAGEMENT

Barrier engagement may be necessary either during an aborted takeoff or after landing with an aircraft malfunction affecting stopping distance or capabilities. Approach the barrier perpendicularly, in a three-point attitude, and, if possible, in the center of the barrier. Prior to engagement, the brakes should be released and then reapplied after passing the barrier. After barrier engagement, actuation of the flight controls or changing aircraft configuration can cause damage to the aircraft.

NOTE

- MA-1, MA-1A, and BAK-15 (61QSII) are the only suitable barriers.
- For MA-1/MA-1A barriers, the minimum engagement speed is approximately 60 knots. The designed dynamic limit for the MA-1 and MA-1A is 150 knots for all aircraft.
- Expect nose or main gear failure above 120 knots if aborting while heavy weight.

Cable failure occurs during attempted engagements above this speed. Engagement may not be successful so pilots must reapply brakes after engagement attempt.

The BAK-15 is a large web-type barrier that fighter-type aircraft have successfully engaged at speeds up to 200 knots. Successful engagement is completely independent of aircraft configuration. Pilots should be aware of the actual barrier position before arrival or departure. It is designed to be activated by tower personnel on command from the pilot and should be in the raised position within 5-7 seconds or it may be left in the raised position continuously.

1. Shoulder harness - LOCK
2. Brakes - DISENGAGE (PRIOR TO BARRIER ENGAGEMENT)
3. Barrier - ENGAGE IN A THREE POINT ATTITUDE

WARNING

To minimize damage to aircraft and possible loss of life, steer the aircraft so as to engage perpendicular to the BAK-15 barrier/net, near the center, and in a three point attitude.

CAUTION

- Discontinue braking just prior to engagement and continue again after barrier is engaged.
- BAK-15 engagements may result in canopy entanglement. In this case do not attempt canopy jettison. Consider use of the canopy breaker tool if egress is required. Opening the canopy prior to engagement may result in serious injury.
- MA-1 and MA-1A barrier engagement is unlikely with the WSSP installed or speed brake open.

4. Brakes - REAPPLY

Refer to Takeoff/Abort charts in T.O. 1T-38C-1-1, Part 2 of Appendix B.

LANDING GEAR RETRACTION FAILURE

If both throttles are below 96%, altitude is below 10,000 feet and airspeed has not increased above 240 KCAS, the landing gear light and landing gear warning horn may remain on. Move one throttle above 96% while remaining below 240 KCAS.

If the warning light in the landing gear lever remains illuminated after the lever has been moved to the LG UP position, proceed as follows:

1. Airspeed - MAINTAIN BELOW 240 KCAS
2. Landing gear - DOWN

NOTE

After placing the landing gear lever down, with a safe gear down indication, do not retract or recycle the gear unless a greater emergency exists.

3. Land as soon as practical.

If unable to raise the landing gear, aircraft will consume approximately 10-15 pounds of fuel per nautical mile.

When configured with gear down and full flaps, the aircraft will burn approximately 60 pounds/minute at low altitudes and airspeeds below 220 KCAS.

HYDRAULIC EMERGENCIES

HYDRAULIC SYSTEMS MALFUNCTIONS

Three different types of hydraulic system malfunctions may be encountered: hydraulic fluid overtemperature, low pressure, and high pressure. The UTILITY HYDRAULIC or FLIGHT HYDRAULIC caution light will illuminate for either a fluid overtemperature or a low pressure condition. To determine the cause of a hydraulic caution light, check indicators. Readings below 1500 PSI indicate a low pressure situation. Momentary drops in pressure sufficient to cause illumination of the hydraulic caution light may be an indication of an unpressurized system. Normal or excessive pressure readings indicate a fluid overtemperature condition. The hydraulic indicators provide the only warning of high hydraulic pressure, a situation that can cause a hydraulic overtemperature condition. Although fluid overtemperature and high pressure usually occur together, it is possible to have one without the other. The corresponding engine should be shut down immediately whenever an overtemperature condition exists. If the right engine is to be shut down, check crossover. If crossover is bad, consider lowering 60% flaps to reduce landing distance and trim the aircraft to final approach airspeed (fuel permitting). If crossover is good, leave generator OFF. If the pressure is high, but not accompanied by a caution light or sluggish controls, land as soon as possible. Be alert for the indications of overtemperature. If a leak is suspected, consider an emergency ground egress.

HYDRAULIC MALFUNCTION (CAUTION LIGHT(S) ON)

WARNING

Hydraulic pressure provided solely by a windmilling engine is insufficient to control the aircraft for landing. An ejection should be accomplished with dual hydraulic system failure.

NOTE

- When a flight hydraulic system fails, utility hydraulic system will operate

flight controls.

- When a utility hydraulic system fails, the stability augmentor, nosewheel steering, normal landing gear extension and speed brake are inoperative.

If the UTILITY HYDRAULIC or FLIGHT HYDRAULIC caution lights illuminate, use the following procedure.

1. Hydraulic pressure indicators - CHECK

If hydraulic pressure is low -

2. Both hydraulic system - MONITOR (AVOID ZERO AND NEGATIVE G FLIGHT.)

WARNING

If one system reads zero, hydraulic system transfer may occur. In this case, flight time could be limited to only 35 minutes.

3. Land as soon as possible.

CAUTION

If utility hydraulic pressure is depleted, stop straight ahead and have gear pins installed prior to clearing runway.

If hydraulic pressure is normal or high (fluid overtemperature) -

2. Affected engine - SHUTDOWN

NOTE

- If the hydraulic caution light goes out, the engine may be restarted if necessary. However, the engine should be left shut down as long as possible to permit maximum cooling of hydraulic fluid.

- If the right engine is to be shut down, check crossover. If crossover is bad, consider lowering 60 % flaps to reduce landing distance and trim the aircraft to final approach airspeed (fuel permitting). If crossover is good, leave generator OFF.
 - The EED fuel flow indicator(s) on the inoperative engine may read as high as 60 PPH.
3. Land as soon as possible.



If utility hydraulic pressure is depleted, stop straight ahead and have gear pins installed prior to clearing runway.

EXCESSIVE HYDRAULIC PRESSURE (CAUTION LIGHT OFF) (IN FLIGHT)

A steady-state hydraulic pressure higher than 3200 PSI in either system must be considered a system malfunction.

1. Affected engine - SHUT DOWN (IF ACCOMPANIED BY SLUGGISH FLIGHT CONTROLS)



Hydraulic pressure provided solely by a windmilling engine is insufficient to control the aircraft for landing. An ejection should be accomplished with dual hydraulic failure.

NOTE

- Sluggish flight controls are indicated by slow or erratic response to normal control inputs. If the actuator seals continue to expand to the point of binding, the flight controls will not respond to stick inputs. In case of binding flight controls, consideration should be given to ejecting

- If the right engine is to be shut down, check crossover. If crossover is bad, consider lowering 60 % flaps to reduce landing distance and trim the aircraft to final approach airspeed (fuel permitting).
 - The EED fuel flow indicator(s) on the inoperative engine may read as high as 60 PPH.
2. Land as soon as possible.
 3. After landing and clear of runway, shut down the affected engine.



If utility hydraulic pressure is depleted, stop straight ahead and have gear pins installed prior to clearing runway.

GEARBOX FAILURE - AIRFRAME MOUNTED

A complete gearbox failure is indicated by simultaneous illumination of the LEFT/RIGHT GENERATOR and hydraulic caution lights for the same engine. Confirm complete gearbox failure by checking the appropriate hydraulic indicator for zero pressure. If the gearbox shaft fails at the designed failure point, there is no associated vibration and the engine is used normally. If the gearbox itself fails (gears, bearings, etc.), excessive vibrations result and the engine is shut down.

If gearbox fails completely and excessive vibrations exist -

1. Throttle gate - DISENGAGE
2. Throttle (affected engine) - OFF

NOTE

The EED fuel flow indicator(s) on the inoperative engine may read as high as 60 PPH.

ELECTRICAL EMERGENCIES

BOTH GENERATORS INOPERATIVE Battery In High State of Charge Left and Right AC Busses Offline

OPERATIVE EQUIPMENT

ENGINE

Afterburner ignition
Engine ignition
Engine start
Fire detection
Nozzle position sensors

FUEL SYSTEM

Crossfeed
Fuel shutoff

**COMMUNICATION/
NAVIGATION EQUIPMENT**

EGI
IFF
Radar altimeter
TACAN
UHF radio (B/U mod only)
VOR/ILS

**FLIGHT CONTROLS/
LIFT & DRAG DEVICES**

Flap position indicator
Speed brake

LANDING GEAR

Landing gear position indicator lights
Landing gear normal extension
Nosewheel steering
WOW system

FLIGHT INSTRUMENTS

EED
MFD (Backup display only)
Standby AI
Standby altimeter

LIGHTING EQUIPMENT

Floodlights (emergency)
Formation Lights
1 Instrument Panel Map light
Utility lights
Warning/Caution/Advisory and indicator lights

OTHER

AAP
ADC
AIU

INOPERATIVE EQUIPMENT

ENGINE

Anti-ice control
EED Left fuel flow OFF
2 EED Right fuel flow OFF
EED Left oil pressure OFF
2 EED Right oil pressure OFF

FUEL SYSTEM

Fuel boost pumps
Fuel low warning
2 Fuel Quantity LT, RT, and Total shows OFF on EED

**COMMUNICATION/
NAVIGATION EQUIPMENT**

TCAS
VHF radio

**FLIGHT CONTROLS/
LIFT & DRAG DEVICES**

Flaps
Hydraulic pressure indicators (Freeze)
YSAS
Trim (all trim)

FLIGHT INSTRUMENTS

AOA indexer lights (all lights illuminated)
AOA indicator
HUD and HUD video camera
MDP
Pitot heater
TAT probe heater
UFCP

LIGHTING EQUIPMENT

Console lights
Instrument lights
Landing/Taxi lights
Floodlights (normal)
Position lights
Rotating beacons

OTHER

Cabin air conditioning
Canopy seal
DTS
Equipment bay cooling
2 Oxygen quantity
Seat adjustment
VTR

NOTE

1 AFTER T.O. 1T-38C-548.

2 Available via static inverter (oxygen/fuel quantity check switch or L/R engine start button).

Figure 3-4. Emergency Power Distribution (Sheet 1 of 7)

**BOTH TRANSFORMER-RECTIFIERS INOPERATIVE
Both Generators Operative
Battery In High State Of Charge**

OPERATIVE EQUIPMENT

ENGINE

Afterburner ignition
Anti-ice control
Engine ignition
Engine start
Fire detection
Hydraulic pressure (L/R)
Nozzle position sensors
Oil pressure (L/R)

FUEL SYSTEM

Crossfeed
Fuel boost pumps
Fuel shutoff

**COMMUNICATION/
NAVIGATION EQUIPMENT**

EGI
IFF
Radar altimeter
TACAN
UHF radio
VOR/ILS

**FLIGHT CONTROLS/
LIFT & DRAG DEVICES**

Flaps
Flap position indicator
YSAS
Speed brake
Trim

LANDING GEAR

Landing gear position Indicator
lights
Landing gear normal extension
Nosewheel Steering
WOW System

FLIGHT INSTRUMENTS

AOA indexer lights
AOA vane heater
DTS
EED
HUD
MFD
Pitot heater
Standby AI
Standby altimeter
TAT probe heater

LIGHTING EQUIPMENT

Console lights
Formation lights
Instrument lights
Landing/Taxi lights
Floodlights (normal)
③ Instrument Panel Map light
Position lights
Rotating beacons
Utility lights
① Warning/Caution/Advisory
and indicator lights

OTHER

AAP
ADC
AIU
Cabin air conditioning
Canopy seal
Equipment bay cooling
MDP
Oxygen quantity
Seat adjustment

INOPERATIVE EQUIPMENT

**COMMUNICATION/
NAVIGATION EQUIPMENT**

② TCAS
② VHF radio

FLIGHT INSTRUMENTS

② UFCP

OTHER

② HUD video camera
② VTR

NOTE

- ① DIM mode available if battery depleted.
- ② 28VDC non-essential bus offline. Inoperative at dual TRU failure.
- ③ AFTER T.O. 1T-38C-548.

Figure 3-4. Emergency Power Distribution (Sheet 2)

T.O. 1T-38C-1

**BOTH TRANSFORMER-RECTIFIERS INOPERATIVE
Both Generators Operative
Battery Dead**

OPERATIVE EQUIPMENT

ENGINE

Anti-ice control
Engine ignition
Hydraulic pressure (L/R)

FUEL SYSTEM

Fuel boost pumps

**FLIGHT CONTROLS/
LIFT & DRAG DEVICES**

Trim

FLIGHT INSTRUMENTS

AOA vane heater
Pitot heater
TAT probe heater

LIGHTING EQUIPMENT

Console lights
Floodlights (normal)
Instrument lights
Landing/Taxi lights
Position lights
Rotating beacons
 Warning/Caution/Advisory
and indicator lights

OTHER

Cabin air conditioning
Canopy seal
Equipment bay cooling
Oxygen quantity
Seat adjustment

INOPERATIVE EQUIPMENT

ENGINE

Afterburner ignition
EEDs
Engine start
Fire detection
Nozzle position sensors

FUEL SYSTEM

Crossfeed
Fuel shutoff

**COMMUNICATION/
NAVIGATION EQUIPMENT**

EGI
HUD
IFF (Mode S)
MDP
Radar altimeter
TACAN
TCAS
UHF radio
VHF radio
VOR/ILS

**FLIGHT CONTROLS/
LIFT & DRAG DEVICES**

Flaps
Flap position indicator
YSAS and rudder trim

Speed brake

LANDING GEAR

Landing gear position indicator lights
Landing gear normal extension
Nosewheel steering

FLIGHT INSTRUMENTS

AOA displays
AOA indexer lights
EED
MFD
Standby AI
Standby altimeter vibrator
UFCP

LIGHTING EQUIPMENT

Formation lights
Landing/taxi light control
 Instrument Panel Map light
Utility lights

OTHER

AAP
ADC
AIU
DTS
HUD video camera
VTR
FLDR, (if installed)

NOTE

- DIM mode available when battery depleted.
 AFTER T.O. 1T-38C-548.

Figure 3-4. Emergency Power Distribution (Sheet 3)

3-28

**LEFT GENERATOR INOPERATIVE
No AC Crossover**

OPERATIVE EQUIPMENT

ENGINE

Afterburner ignition
Anti-ice control
EGT (L/R)
Engine ignition
Engine start
Fire detection
Hydraulic pressure (R)
Nozzle position (L/R)
Oil pressure (R)
RPM (L/R)

FUEL SYSTEM

Crossfeed
Fuel low warning
Fuel shutoff (L/R)
Right fuel boost pump
Right fuel flow

**COMMUNICATION/
NAVIGATION EQUIPMENT**

EGI
IFF
Radar altimeter
TACAN
VHF radio
VOR/ILS
UHF radio

**FLIGHT CONTROLS/
LIFT & DRAG DEVICES**

Flaps (control/motors)
Flap position indicator
Speed brake
Trim (pitch and roll)

LANDING GEAR

Landing gear position indicator
lights
Landing gear normal extension
Nosewheel steering
WOW system

FLIGHT INSTRUMENTS

EED
HUD
MFD
Pitot heater
Standby AI
Standby altimeter
Standby VVI
TAT probe heater
UFCP

LIGHTING EQUIPMENT

Formation lights
Floodlights (normal)
☐ Instrument Panel Map light
Utility lights
Warning/Caution/Advisory and
indicator lights (bright/dim)

OTHER

AAP
ADC
AIU
Cabin air conditioning
Canopy seal
DTS
Equipment bay cooling
HUD video camera
MDP
Oxygen quantity
Seat adjustment
TCAS

INOPERATIVE EQUIPMENT

ENGINE

Hydraulic pressure (L) (freeze)
Oil pressure (L) (OFF)

FUEL SYSTEM

Left fuel boost pump
Left fuel flow (indicates OFF)

**FLIGHT CONTROLS/
LIFT & DRAG DEVICES**

Rudder trim control
YSAS

FLIGHT INSTRUMENTS

ADC AOA Functions
AOA indexer lights (all lights
illuminated)
AOA indicator
AOA vane heater
Flap synchro input OFF

LIGHTING EQUIPMENT

Console lights
Instrument lights
Landing/Taxi lights
Position lights
Rotating beacons

NOTE

☐ AFTER T.O. 1T-38C-548.

Figure 3-4. Emergency Power Distribution (Sheet 4)

**RIGHT GENERATOR INOPERATIVE
No AC Crossover**

OPERATIVE EQUIPMENT

ENGINE

Afterburner ignition
Anti-ice (defaults to ON)
Engine ignition
Engine start
EGT (L/R)
Fire detection
Hydraulic pressure (L)
Oil pressure (L)
Nozzle position (L/R)
RPM (L/R)

FUEL SYSTEM

Crossfeed
Fuel shutoff (L/R)
Left fuel boost pump
Left fuel flow

**COMMUNICATION/
NAVIGATION EQUIPMENT**

EGI (last destination selected)
IFF (last squawk selected
Mode S)
Radar altimeter
TACAN (B/U mode)
TCAS (last mode selected)
UHF radio (B/U mode)
VHF radio (last freq selected)
VOR/ILS (B/U mode)

**FLIGHT CONTROLS/
LIFT & DRAG DEVICES**

Flap position indicator
Speed brake

LANDING GEAR

Landing gear position indicator
Lights
Landing gear normal extension
Nosewheel steering
WOW system

FLIGHT INSTRUMENTS

AOA indexer lights
AOA vane heater
EED
MFD (B/U display only)
Standby AI
Standby altimeter
Standby VVI

LIGHTING EQUIPMENT

Console lights
Floodlights (emergency)
Formation lights
2 Instrument Panel Map light
Instrument lights
Landing/Taxi lights
Position lights
Rotating beacons
Utility lights
Warning/Caution/Advisory and
indicator lights (bright)

OTHER

AAP
ADC
AIU

INOPERATIVE EQUIPMENT

ENGINE

1 Hydraulic pressure (R)
(freeze)
1 Oil pressure (R) (OFF)

FUEL SYSTEM

Fuel low warning
1 Fuel quantity (indicates
OFF)
Fuel boost pump (R)
1 Right Fuel Flow (indicates
OFF)

**FLIGHT CONTROLS/
LIFT & DRAG DEVICES**

Flap motors
YSAS (MDP is inop)
Trim (all)

FLIGHT INSTRUMENTS

HUD
HUD Video Camera
MDP
Pitot heater
TAT probe heater
UFCP (Blank -- MDP is inop)

LIGHTING EQUIPMENT

Floodlights (normal)
Landing/Taxi light control

Warning/Caution/Advisory and
indicator lights (dim)

OTHER

Cabin air conditioning
Canopy seal
DTS (MDP is inop)
Equipment bay cooling
1 Oxygen quantity
Seat adjustment

NOTE

- 1 Available via static inverter (oxygen/fuel quantity check switch or L/R engine start button).
2 AFTER T.O. 1T-38C-548.

Figure 3-4. Emergency Power Distribution (Sheet 5)

LEFT ESSENTIAL DC BUS FAILURE**OPERATIVE EQUIPMENT****ENGINE**

Afterburner ignition
EGT (L/R)
Engine ignition
Engine start
Fire detection
Hydraulic pressure (L/R)
Nozzle position (L/R)
Oil pressure (L/R)
RPM (L/R)

FUEL SYSTEM

Boost pump (L/R)
Crossfeed light
Fuel quantity

**COMMUNICATION/
NAVIGATION EQUIPMENT**

AIU
EGI (last destination selected)
Intercom
Radar altimeter
TACAN
UHF radio
UHF radio (B/U mode)

**FLIGHT CONTROLS/LIFT &
DRAG DEVICES**

YSAS
Trim

LANDING GEAR

Landing gear position indicator
lights (dim)
Landing gear normal extension
Nosewheel steering
WOW system

FLIGHT INSTRUMENTS

ADC
AOA indicators
AOA vane heater
Flap position indicator
HUD
MFD (both)
Pitot heater
Standby airspeed indicator
Standby VVI
TAT probe heater

LIGHTING EQUIPMENT

Console lights
Floodlights (normal)
Instrument lights
Landing/Taxi lights
Position lights
Rotating beacons
Warning/Caution/Advisory and
indicator lights (dim)

OTHER

Cabin air conditioning
Canopy seal
DTS
Equipment bay cooling
Generator control switches
MDP
Oxygen quantity
Seat adjustment

INOPERATIVE EQUIPMENT**ENGINE**

Left fire light inop (test
function only)

FUEL SYSTEM

Crossfeed
Fuel low warning (L/R)
Fuel shutoff (L/R)
Fuel flow (L/R) indicate 0

**COMMUNICATION/
NAVIGATION EQUIPMENT**

IFF (Mode S transponder)
NAV B/U control panel
VHF radio
VOR/ILS

**FLIGHT CONTROLS/LIFT &
DRAG DEVICES**

Flap control
Speed brake

LANDING GEAR

Landing gear position indicator
lights (bright)

FLIGHT INSTRUMENTS

AOA indexer lights
Standby AI (valid indications
for a minimum of 9 minutes)
Standby altimeter vibrator
(altimeter accuracy degraded)
UFCP

LIGHTING EQUIPMENT

Floodlights (emergency)
Formation lights
☐ Instrument Panel Map light
Utility lights
Warning/Caution/Advisory and
indicator lights (bright)

OTHER

AAP
HUD video camera
Oxygen Quantity Low Level
Warning
TCAS
VTR

NOTE

☐ AFTER T.O. 1T-38C-548

Figure 3-4. Emergency Power Distribution (Sheet 6)

RIGHT ESSENTIAL DC BUS FAILURE

OPERATIVE EQUIPMENT

ENGINE

Afterburner ignition
 Anti-ice control
 Engine ignition
 Engine start
 Hydraulic pressure (L/R)

FUEL SYSTEM

Boost pump (L/R)
 Crossfeed
 Fuel shutoff (L/R)

COMMUNICATION/

NAVIGATION EQUIPMENT

AIU
 IFF (Mode S no altitude reporting)
 Intercom
 Nav B/U control panel
 VHF radio
 VOR/ILS

FLIGHT CONTROLS/LIFT & DRAG DEVICES

Flaps
 Speed brake
 Trim (pitch and roll)

LANDING GEAR

Landing gear position indicator lights (except RCP nose)

FLIGHT INSTRUMENTS

AOA vane heater
 HUD (CDI/VOR bearing pointer only)
 Pitot heater
 Standby AI
 Standby airspeed indicator
 Standby altimeter vibrator (degraded accuracy)
 Standby VVI
 UFCP

LIGHTING EQUIPMENT

Console lights
 Floodlights (normal/emergency)
 Formation lights
 Instrument Panel Map light
 Instrument lights
 Position lights
 Rotating beacons
 Utility lights
 Warning/Caution/Advisory and indicator lights (bright)

OTHER

AAP
 Cabin air conditioning
 Canopy seal
 Equipment bay cooling
 Generator control switches
 HUD video camera
 MDP
 Oxygen quantity/low level warning
 Seat adjustment
 VTR

INOPERATIVE EQUIPMENT

ENGINE

EED (both)
 Fire detection

COMMUNICATION/

NAVIGATION EQUIPMENT

EGI
 Radar altimeter
 TACAN
 UHF B/U control panel
 UHF radio

FLIGHT CONTROLS/LIFT & DRAG DEVICES

Flap position indicator
 YSAS

LANDING GEAR

Landing gear normal extension
 Landing gear warning (tones/lights)
 Nosewheel steering
 WOW system

FLIGHT INSTRUMENTS

AOA indexer lights (all lights illuminated)
 AOA System (AOA displays blank)
 MFD (both)

LIGHTING EQUIPMENT

Landing/Taxi lights

OTHER

ADC
 DTS
 TCAS (Standby only, no RA, no TA)
 FLDR (if installed)

NOTE

1 AFTER T.O. 1T-38C-548

Figure 3-4. Emergency Power Distribution (Sheet 7)

GENERATOR FAILURE (IN FLIGHT)**NOTE**

- A complete gearbox failure is indicated by simultaneous illumination of the LEFT/RIGHT GENERATOR and hydraulic caution lights for the same engine, refer to GEARBOX FAILURE - AIRFRAME MOUNTED, this section.
- See Figure 3-4 for operative and inoperative equipment.

If LEFT/RIGHT GENERATOR light on -

1. RPM (affected engine) - ADJUST ENGINE RPM WITH FAILED GENERATOR TO OPPOSITE SIDE OF SHIFT RANGE (65-75 %).
2. Generator - RESET, THEN ON



Refrain from attempting to reset the generator more than once due to the danger of the generator burning.

If gearbox failure to shift suspected, refer to GEARBOX FAILURE TO SHIFT, this section.

If LEFT/RIGHT GENERATOR light stays on -

3. Generator - OFF
4. Land as soon as practical.
5. After landing, shut down engine with failed generator after clearing runway.

If MDP reboots, refer to MDP REBOOT, this section.

GENERATOR FAILURE (NO AC CROSSOVER)**NOTE**

See Figure 3-4 for operative and inoperative equipment.

Left/right no AC crossover indications are as follows:

Left generator no cross INDICATIONS

- All AOA indexer lights on.

- Utility hydraulic gauge freezes. Left oil pressure and left fuel flow EED indications display OFF.
- MASTER CAUTION, LEFT GENERATOR, LEFT FUEL PRESS lights illuminate.
- At night, all interior and exterior lights except caution, warning and indicator lights, flood lights, and utility lights lost.

Right generator no cross INDICATIONS

- Flight hydraulic gauge freezes, right fuel flow and both fuel quantity EED indications display OFF. Oil pressure indications freeze.
- MASTER CAUTION, RIGHT GENERATOR, RIGHT FUEL PRESS and ENG ANTI-ICE ON lights illuminate.
- At night, when Caution and Warning lights are set to DIM, Caution, Warning and Indicator lights go to bright.

If LEFT/RIGHT GENERATOR light on -

1. RPM (affected engine) - ADJUST ENGINE RPM WITH FAILED GENERATOR TO OPPOSITE SIDE OF SHIFT RANGE (65-75 %)
2. Generator - RESET, THEN ON



If the generator resets (right generator affected), consider setting the flaps at 60 % and trim the aircraft for level flight (fuel permitting).



Refrain from attempting to reset the generator more than once due to the danger of the generator burning.

If LEFT/RIGHT GENERATOR light is extinguished, proceed to step 5.

If LEFT/RIGHT GENERATOR light stays on -

3. Generator - OFF
4. Descend below 25,000 feet if practical.

T.O. 1T-38C-1

5. Land as soon as practical.



If the generator does not reset (right generator affected), consider burning down fuel if no flap landing distance is critical.

6. After landing, shut down engine with failed generator after clearing the runway.

If MDP reboots, refer to MDP REBOOT, this section.

GENERATOR FAILURE - PARTIAL

NOTE

See Figure 3-4 for operative and inoperative equipment.

The loss of certain electrical components without illumination of the LEFT/RIGHT GENERATOR light may indicate the loss of one or two phases of an AC generator.

Three phase AC items include the following:

- Boost pump (LEFT/RIGHT FUEL PRESS light may be on)
- Transformer-rectifier (XMFR RECT OUT light on)
- Flaps (slow flap actuation)
- HUD (two or more phase failures required to affect HUD operations)

If conditions permit -

1. Identify the affected generator by reference to the circuit breaker diagram in Section 1.
2. Affected generator switch - OFF

If malfunction not corrected -

3. Affected generator switch - ON
4. Land as soon as practical.

GEARBOX FAILURE TO SHIFT

A gearbox failure to shift is indicated when the LEFT or RIGHT GENERATOR caution light illuminates when accelerating or decelerating thru the shift range of 65-75 % RPM.

1. RPM (affected engine) - RETURN TO RANGE WHERE GENERATOR OPERATION CAN BE MAINTAINED
2. Generator switch - RESET THEN ON, IF NECESSARY
3. RPM (affected engine) - LEAVE IN RANGE OF SUCCESSFUL GENERATOR OPERATION UNTIL ON FINAL APPROACH, THEN USE AS NECESSARY TO COMPLETE LANDING.
4. Land as soon as practical.

DUAL TRANSFORMER-RECTIFIER FAILURE

NOTE

- See Figure 3-4 for operative and inoperative equipment.
- Turn FLDR power switch - OFF, if installed.

Illumination of the XMFR RECT OUT caution light indicates a failure of both transformer-rectifiers. If both transformer-rectifiers have failed, systems requiring DC power are supplied by the battery. Battery life is approximately 15 minutes. Decrease DC load and maintain VMC.

To conserve battery power, consider turning the following list of equipment off, in the order indicated, to reduce battery drain (may prolong battery life).

- a. MFD (AFT)
- b. MFD (FWD)
- c. EED (AFT)
- d. EED (FWD)
- e. UHF
- f. EGI
- g. VOR/ILS/DME
- h. TACAN
- i. EMERG white flood lights
- j. Formation Lights

XMFR RECT OUT will extinguish when the battery is dead.

1. Transformer-rectifier circuit breakers - IN (transformer-rectifier circuit breakers are located on the FCP center pedestal and the RCP left console.)
2. AAP backup mode control knob - BOTH
3. COCKPIT INSTRUMENTS rheostat - OUT OF OFF
4. Warning/ Caution/ Advisory lights BRIGHT/ DIM switch - DIM
5. Land as soon as practical.



If complete DC failure occurs with the landing gear extended, downside hydraulic pressure is lost.

NOTE

If necessary to clear the runway, the landing gear should be pinned prior to taxi.

ELECTRICAL FIRE

1. Oxygen - 100 %
2. CABIN PRESS switch - RAM DUMP (BELOW 25,000 FEET, IF POSSIBLE)
3. BATTERY and L GEN/R GEN - OFF

NOTE

With boost pumps inoperative, engine flameout may occur if above 25,000 feet.

4. All electrical equipment - OFF

NOTE

- Refer to appropriate items on AFTER LANDING and ENGINE SHUT-DOWN checklists to ensure all electrical equipment is off.
- Turn FLDR power switch - OFF, if installed.

5. Battery, generator(s), electrical equipment - ON (AS NECESSARY FOR FLIGHT AND LANDING)

NOTE

- Turn on the battery first. This allows DC power until the battery is dead. Turn on equipment only as needed for safe flight.
- If AC power is necessary, turn either generator ON. If the battery was left OFF intentionally, pull the TR circuit breakers before turning the generator ON.
- If smoke appears, turn off the last switch that was turned on.
- See Figure 3-4, for operative and inoperative equipment.
- Maintain VMC.

ELECTRICAL FAILURE - COMPLETE

With complete electrical failure, all warning systems, engine instruments, flight trim, communication and navigation systems, speed brake, flaps, landing gear normal extension, landing gear indicators, nosewheel steering, fuel boost pumps, and engine ignition system are inoperative; each engine anti-ice valve opens. Plan to fly an Electrical Failure pattern. A no flap landing will be required. The landing gear must be extended using the alternate system.

Use the following procedures:

T.O. 1T-38C-1

1. BATTERY switch - CHECK ON
2. Generator switches - RESET, THEN ON
Hold generator switches at RESET momentarily, then return switches to ON in an attempt to regain electrical power.

If generators fail to reset -

3. Generator switches - OFF
4. Descend to lowest practical altitude below 25,000 feet. Attempt to maintain VMC.
5. Land as soon as practical.

RIGHT ESSENTIAL 28 VOLT DC BUS FAILURE

NOTE

See Figure 3-4 for operative and inoperative equipment.

The right essential 28 VDC bus is protected by a circuit breaker on the dc power panel in the nose equipment bay. This circuit breaker, when open, isolates a fault to the right essential 28 VDC bus and prevents loss of the entire dc power system.

Loss of TACAN and UHF radio indicates right essential 28 VDC bus failure.

WARNING

Failure of the right essential 28 VDC bus circuit breaker results in loss of TACAN and UHF radio. VOR numerical bearing is the only usable information on the HUD. The VOR bearing pointer is unreliable.

1. Refer to standby instruments for airspeed, altitude and attitude, and magnetic compass for heading.
2. BATTERY switch - ON
3. Proceed to VMC as soon as possible.
4. Remain VMC, if possible.
5. IFF - SQUAWK 7700
6. Emergency field - SELECT
7. AAP - NAV B/U
8. Navaid frequency - TUNE ON NAV BACKUP CONTROL PANEL
9. Bearing - SELECT ON NAV BACKUP CONTROL PANEL
10. Navigate to selected field using bearing and magnetic compass.

11. Land as soon as practical.
12. Landing gear - USE ALTERNATE EXTENSION
13. Flaps - CONFIRM POSITION VISUALLY BEFORE LANDING

LEFT ESSENTIAL 28 VOLT DC BUS FAILURE

NOTE

See Figure 3-4 for operative and inoperative equipment.

The left essential and nonessential 28 volt DC busses are protected by a circuit breaker on the dc power panel in the nose equipment bay. This circuit breaker, when open, isolates a fault to the left essential and nonessential 28 volt DC busses and prevents loss of the entire dc power system. Total loss of both UFCPs and the NAV backup control panel indicate left essential 28 volt VDC bus failure.

WARNING

Failure of the left essential 28 VDC bus circuit breaker results in loss of VHF radio communications. In addition, VOR/ILS is lost and DME is operational but limited to the last channel that was tuned. TACAN range and bearing is operational and steering information is accurate but limited to the last selected EGI destination. Flap control and speed brake are not operative. Landing gear operates normally, but position/warning lights function only in dim mode, if dim mode is selected. Attitude information is limited to a minimum of 9 minutes based on standby attitude indicator inertia.

1. Refer to PFR display for airspeed, altitude, attitude, and heading.
2. BATTERY switch - ON
3. Proceed to VMC as soon as possible.
4. Remain VMC, if possible.
5. Land as soon as practical.

If this malfunction occurs with flaps retracted, a no flap landing is necessary.

FUEL EMERGENCIES

FUEL QUANTITY INDICATOR AND LOW-LEVEL CAUTION LIGHT SYSTEM MALFUNCTION

Fuel quantity indicator sensor data failure causes blanking of the failed system's bar indicator, loss of the failed system fuel quantity readout (replaced by FAIL or OFF), and loss of the total fuel readout, (replaced by FAIL or OFF). When fuel quantity indicator failure is experienced, the fuel low-level caution light is unreliable. Failure of the fuel low-level caution system is indicated when either fuel quantity indicator reads less than 250 pounds and the low-level light does not illuminate. With fuel quantity indicator failure or low-level caution system failure, closely monitor the fuel quantity and land as soon as practical.

1. Fuel quantity - MONITOR

WARNING

Do not attempt crossfeed operation with a fuel quantity indicator inoperative as it will be impossible to monitor the fuel balance.

2. Land as soon as practical.

LOW FUEL PRESSURE/FUEL LEAK

Momentary blinking of the LEFT or RIGHT FUEL PRESSURE light(s) can be due to a fuel requirements surge, such as initiating afterburner. This is not a malfunction. Monitor systems for fuel imbalance.

Turning crossfeed on should cause the LEFT/RIGHT FUEL PRESSURE light(s) to go out. If not, the possibility of a fuel leak must be considered.

The possibility of fire is normally of prime concern with any fuel leak. With a fuel leak, consider shutting down the affected engine because of the fire possibility. However, with a massive leak, the fuel loss itself must be dealt with promptly and correctly to ensure that sufficient fuel remains to return to base.

Monitor systems for fuel imbalance. If generator phase failure is suspected, refer to GENERATOR FAILURE - PARTIAL, this section.

If LEFT FUEL PRESS or RIGHT FUEL PRESS caution light comes on -

1. CROSSFEED switch - ON

If FUEL PRESSURE light goes out indicating boost pump failure proceed to step 7 -

If FUEL PRESSURE light stays on indicating possible leak or pressure sensor malfunction, continue through step 6 -

2. CROSSFEED switch - OFF
3. Fuel status - MONITOR (DETERMINE IF LEAK EXISTS)

WARNING

Because an internal fuel leak can cause a fire or explosion, if a fuel leak is verified, strongly consider shutting down affected engine via normal throttle cutoff. Make sure corresponding fuel pump is turned off.

If an external fuel leak exists indicated by excessive fuel quantity drop, vapor trail, and/or verification by other aircraft -

4. Throttle (affected engine) - OFF

NOTE

The EED fuel flow indicator(s) on the inoperative engine may read as high as 60 PPH.

5. Boost pump (affected engine) - OFF
6. Land as soon as possible.
7. Boost pump circuit breakers - CHECK

NOTE

- Boost pump circuit breaker are located on the left and right RCP circuit breaker panels. If a generator phase

T.O. 1T-38C-1

failure is suspected, there will be other indications.

- Failure of certain electrical components, such as the boost pumps, without a generator light, can indicate the loss of one or two phases of AC generator. See Figure 3-4 to isolate the specific phases lost.

If circuit breakers are not popped, will not reset or unable to check circuit breakers proceed to step 12 -

If circuit breakers (RCP) are popped - continue through step 11 -

8. Boost pump (affected engine) - OFF
9. Circuit breakers - RESET (RESET A BOOST PUMP CIRCUIT BREAKER ONE TIME ONLY)

If circuit breakers remain set -

10. Boost pump (affected engine) - ON

If L/R pressure caution light goes out -

11. CROSSFEED switch - OFF

NOTE

If circuit breakers remain set, mission can be continued.

12. Descend below 25,000 feet MSL.
13. Power - REDUCE

NOTE

If a reduced power setting at high altitude is impractical, place the CROSSFEED switch ON to minimize the possibility of fuel flow interruption. Monitor the fuel balance and descend as soon as practical.

14. CROSSFEED switch - OFF
15. Land as soon as practical.

OXYGEN EMERGENCIES

SMOKE, FUMES, OR ODORS IN COCKPIT, IN FLIGHT

All odors not identifiable shall be considered toxic.

Vibrations accompanied by fumes and/or odors from the air conditioning system may indicate air conditioner turbine failure. If this condition is suspected, select oxygen 100%, descend below FL250 and select RAMP DUMP to deactivate the air conditioning system. This should stop the vibrations.

1. Oxygen - 100%

NOTE

- If odors persist, consider use of emergency oxygen cylinder.
 - If the emergency oxygen system is activated, disconnect from normal aircraft oxygen system.
2. Check for fire.
 3. CABIN PRESS switch - RAM DUMP (BELOW 25,000 FEET, IF POSSIBLE)
 4. If smoke becomes severe - JETTISON CANOPY (BELOW 300 KCAS, IF POSSIBLE)

CABIN PRESSURE LOSS

1. Oxygen system - CHECK 100% AND EMERGENCY (BELOW 25,000 FEET OXYGEN SYSTEM OPERATION MAY BE RETURNED TO NORMAL.)
2. Descend immediately. Maintain aircraft at or below 25,000 feet (below 18,000 feet desired).
3. Land as soon as practical.

OXYGEN SYSTEM EMERGENCY OPERATION

Plan on using approximately 1 liter/hour.

The OXYGEN low level caution light illuminates when the oxygen indicator reads 1 liter or less of liquid oxygen. The light may blink (due to sloshing) if the system contains less than 3 liters.

If hypoxia/ hyperventilation symptoms are detected -

1. Supply lever - CHECK ON
2. Diluter lever - 100% OXYGEN
3. Emergency lever - EMERGENCY
4. Connections - CHECK SECURITY

WARNING

- If positive pressure is not felt after completing step 4 or oxygen system contamination is suspected, consider use of the emergency oxygen cylinder. If oxygen system contamination is suspected, further consideration should be given to disconnecting the aircraft oxygen hose after activating the emergency oxygen cylinder.
 - If the emergency oxygen system is activated, disconnect from normal aircraft oxygen system.
5. Breathe at a rate and depth slightly less than normal until symptoms disappear.
 6. Descend below 10,000 feet MSL (cabin pressure) and land as soon as practical.

ENGINE EMERGENCIES

SINGLE-ENGINE FLIGHT CHARACTERISTICS

Single-engine directional control can normally be maintained at all speeds above stall. Very little rudder is required because of the close proximity of the thrust lines to the centerline of the aircraft. In high-drag, high-thrust, low-air-speed conditions, rudder must be used to coordinate flight to obtain optimum aircraft performance.

There are conditions under which the aircraft will not maintain altitude in takeoff configuration or landing configuration with one engine operating at either MIL or MAX thrust. Final approach speed will insure excess thrust is available for go around.

Minimum single-engine flying speed for any condition occurs where the thrust available and thrust required lines cross. If the airspeed is less than the minimum speed, altitude must be sacrificed to attain this minimum and/or the configuration must be changed to reduce the drag. Every effort should be made to immediately attain a speed that will give excess thrust. It is imperative that the speed brake be closed during all single-engine flight to obtain the performance stated in the single-engine charts.

The single-engine service ceiling can be attained by following the climb schedule shown in the Single-Engine Service Ceiling chart. Refer to T.O. 1T-38C-1-1.

FIRE WARNING DURING FLIGHT (AFFECTED ENGINE)

An illuminated fire warning light may be a valid fire indication even though the test circuit may be inoperative.

1. THROTTLE - IDLE

WARNING

When a FIRE light is preceded or accompanied by a pop, bang, or thump it usually indicates a serious malfunction and/or fire. Consider shutting down the engine. If engine has seized, place throttle to cutoff even if the FIRE light has gone out.

CAUTION

If the FIRE light goes out, check the light by positioning the WARNING TEST switch to TEST. If one or both bulbs of the affected FIRE light does not illuminate, it indicates a possible burn-through of one or both fire sensors. In this case, shut the engine down.

2. THROTTLE - OFF, IF FIRE LIGHT REMAINS ON

WARNING

- Do not delay placing the throttle to OFF due to possible rapid loss of flight control system from the damage.
- If engine cannot be shut down with the throttle, the FUEL SHUTOFF switch (affected engine) should be closed.

CAUTION

Do not attempt to restart the affected engine if the fire is extinguished. Make a single-engine landing.

NOTE

The EED fuel flow indicator(s) on the inoperative engine may read as high as 60 PPH.

3. IF FIRE IS CONFIRMED - EJECT

NOTE

Before abandoning the aircraft, confirm the fire by one or more of the following indications: fluctuating fuel flow, excessive EGT, vibrations, erratic engine operation, roughness, smoke trailing the aircraft or smoke in the cockpit.

4. Land as soon as possible.

RPM EXCEEDANCE (LATCHED RPM)

If the EED indicates a latched RPM exceedance condition, retard throttle to the setting at which the RPM of the affected engine decreases and remains within limits.

1. Throttle - RETARD TO MAINTAIN RPM WITHIN LIMITS
2. Land as soon as practical.

ENGINE TEMPERATURE EXCEEDANCE (NON LATCHED EGT)

If exhaust gas temperature (EGT) exceeds engine operating limitations (Figure 5-3), immediately retard throttle to the setting at which the EGT of the affected engine decreases and remains within limits.

1. Throttle - RETARD TO MAINTAIN EGT WITHIN LIMITS
Monitor EGT during throttle manipulation of the affected engine.

If full spectrum engine operations cannot be reestablished -

2. Land as soon as practical.

ENGINE OVERTEMPERATURE (LATCHED EGT)

If the EED indicates a latched EGT overtemperature condition, immediately retard throttle to the setting at which the exhaust gas temperature of the affected engine decreases and remains within limits.

1. Throttle - RETARD TO MAINTAIN EGT WITHIN LIMITS
2. Land as soon as practical.
Monitor systems for EGT exceedance throughout the remainder of the sortie.

OIL SYSTEM MALFUNCTION

Abnormal engine oil pressure indications frequently are an early indication of some engine trouble. The engine oil pressure indicators display engine oil pressure on the ground and in the air.

During cold weather starts, oil pressure usually exceeds 55 psi. To expedite oil warm-up, engine may be operated at MIL power or below (do not exceed 5-minute time limit in MIL power). If oil pressure does not return to operating limits within 6 minutes after engine start (5-20 PSI at idle), shut down engine.

If engine oil pressure is not within the operating limits or a sudden change of 10 PSI or more occurs at any stabilized RPM, proceed as follows:

1. Throttle - ADJUST (MAINTAIN PRESSURE WITHIN LIMITS)

NOTE

Simultaneous failure of the engine RPM indications and oil pump (oil pressure indicates zero) may be an indication of a sheared oil pump shaft.

If a latched oil pressure high or low occurs -

2. Return to normal flight conditions.
3. Land as soon as practical.

If 5 to 55 PSI pressure cannot be maintained or if engine seizure appears imminent -

4. Throttle gate - DISENGAGE
5. Throttle - OFF

NOTE

- If the operating engine requires shutdown, the engine previously shutdown for oil system malfunction may be restarted.
- If the right engine is to be shutdown, check crossover. If crossover is bad, consider lowering 60% flaps to reduce landing distance and trim the aircraft to final approach airspeed (fuel permitting). If crossover is good, leave generator OFF.
- The EED fuel flow indicator(s) on the inoperative engine may read as high as 60 PPH.

NOZZLE FAILURE

If nozzle failure occurs in closed range, excessive EGT is possible. If this condition occurs, follow the Engine Overtemperature procedure. If a nozzle fails in the

T.O. 1T-38C-1

open position, low EGT will result. The affected engine will operate from IDLE to MIL, but with a much lower thrust output. Afterburner may not be available. Depending on the severity of either condition, consideration should be given to recovering the aircraft in accordance with single engine landing procedures.

CAUTION

If the nozzle is closed, EGT can increase above acceptable limits during landing rollout or taxi. If this occurs, the engine should be shut down.

NOZZLE STUCK CLOSED (AT OR NEAR ZERO)

Malfunction indications are as follows:
Nozzle position closed (approximately 0%) and excessive EGT with high power settings.

The following considerations apply:

- a. Engine may be used if EGT is kept within limits.
- b. MAX power probably will not be available on engine with the stuck nozzle.
- c. Due to reduced airflow, use caution for engine overtemperature.
- d. Consider using single-engine procedures for approach and landing.
- e. Fly a straight-in approach.
- f. EGT may increase above acceptable limits. If this occurs shut down engine.
 1. Throttle - RETARD TO MAINTAIN EGT WITHIN LIMITS
 2. Land as soon as practical.

NOZZLE STUCK OPEN (IN THE OPEN RANGE, 20-100%)

Malfunction indications are as follows:
Nozzle position open (20-85%), dependent on throttle setting at the time of failure (MIL or MAX) and low EGT for respective throttle settings.

The following considerations apply:

- a. Expect thrust output to be decreased.
- b. MAX power probably will not be available on engine with the stuck nozzle.
 1. Abort mission.
 2. Land as soon as practical.

FLUCTUATING NOZZLE

Malfunction indications are as follows:
Nozzle position fluctuations greater than + 3% (MIL or MAX) with none allowed in IDLE on the ground.

The following considerations apply:

- a. Possible T5 failure.
- b. EGT may fluctuate with the nozzle.
- c. Cross check fuel flow to prevent misinterpreting a fluctuating nozzle as a fuel control problem.
- d. Fly a straight-in approach using single-engine procedures (gear and 60% flaps with the unaffected engine as the primary thrust source).
 1. Throttle - RETARD UNTIL NOZZLE STABILIZES
 2. Land as soon as practical.

ENGINE FAILURE/SHUTDOWN DURING FLIGHT

If an engine operates abnormally or fails during flight, reduce drag to a minimum and maintain airspeed and directional control while investigating to determine the cause. Failure of the left engine may deactivate speed brake, normal landing gear extension and retraction, nosewheel steering and the stability augmentor system. However, left engine windmilling RPM under this condition may supply sufficient hydraulic pressure to operate these systems. Use the following procedure for shutting down an engine in flight.

CAUTION

- Certain failures of the main fuel control may result in an engine remaining at the power setting selected at the time of failure despite additional throttle movements. With an engine stuck at a high power setting, consider shutting down the engine to preclude excessively fast landing speeds which may result in extremely hot brakes and possible barrier engagement/runway departure. If the engine cannot be shut down with the throttle, close the affected fuel shutoff switch.
- Do not attempt a restart if the engine was shut down due to FOD, fire or if the engine is frozen.

- Any abnormal engine noise may be an indication of engine damage, even with normal engine indications displayed on EED.

1. Safe single-engine airspeed - MAINTAIN
2. Throttle gate - DISENGAGE
3. Throttle (affected or inoperative engine) - OFF FOR 10 SECONDS BEFORE ATTEMPTING A START IF CONDITIONS PERMIT

NOTE

The EED fuel flow indicator(s) on the inoperative engine may read as high as 60 PPH.

4. CROSSFEED - AS NECESSARY

WARNING

With CROSSFEED ON and either both BOOST PUMPS ON or both BOOST PUMPS OFF, a rapid fuel imbalance can occur.

5. Land as soon as possible.

With fuel less than 250 pounds in either system -

6. LEFT and RIGHT BOOST PUMP switches - ON
7. CROSSFEED switch - ON

NOTE

Under single-engine low fuel conditions (approximately 250 pounds in either system) with two operating boost pumps, placing the CROSSFEED ON and both BOOST PUMPS ON will provide the maximum usable fuel.

8. Land as soon as possible.

Refer to T.O. 1T-38C-1-1 for Single-Engine Diversion Range Summary Table.

RESTART DURING FLIGHT

Airstarts can be expected over the range of operating conditions shown in Figure 3-5. The engine air start requirements are based on engine windmill speed and

pressure altitude and are independent of ambient temperature. Lines of constant indicated airspeed have been superimposed on the basic engine requirements. These are indicated airspeeds required to achieve corresponding windmill speeds. A minimum of 12-14 % RPM is required to achieve any engine fuel flow. 18-20 % engine RPM is the heart of the airstart envelope at all altitudes. Airstart attempts in the area above the upper left hand corner of the envelope will normally result in a hung start. If airspeed is increased and/or altitude decreased with an engine in a hung start, it may accelerate up to operating speed. Airstart attempts at engine windmill speeds higher than the upper limit will normally fail because of a lean mixture (low fuel/air ratio). Combustion may be established by decreasing airspeed and/or decreasing altitude. Since the ignition circuitry is engaged for about 30 seconds after pushing the start button, it may be necessary to press the start button again. Use the following procedure.

1. Throttle gate - DISENGAGE
2. Throttle (affected engine) - OFF (10 SECONDS, IF CONDITIONS PERMIT)

NOTE

The EED fuel flow indicator(s) on the inoperative engine may read as high as 60 PPH.

3. Altitude - BELOW 25,000 FEET
4. Engine RPM - WITHIN AIRSTART ENVELOPE, 12 % MINIMUM
18-20 % is the heart of the airstart envelope at all altitudes.
5. BATTERY switch - ON
6. BOOST PUMP switches - CHECK ON
7. Engine start and ignition circuit breakers - IN (LEFT CONSOLE IN THE FCP)
8. ENGINE START button (affected engine) - PUSH
9. Throttle - ADVANCE TO IDLE

NOTE

- Leave throttle at IDLE for 30 seconds before aborting a start.
- If dual engine flameout occurs, the right engine should be attempted first as right engine instruments will operate normally as soon as engine start button is pushed.

T.O. 1T-38C-1

If restart attempt fails -

10. Throttle (affected engine) - OFF (FOR APPROXIMATELY 10 SECONDS)
11. CROSSFEED switch - ON
12. Attempt another restart.

NOTE

- The RPM may hang up during restart after combustion occurs at low airspeeds. This may be eliminated by increasing airspeed.
- If it appears that a boost pump has failed, remain below 25,000 feet and turn CROSSFEED OFF to avoid having to use an abnormal fuel balancing procedure.
- If it appears that a boost pump has failed and flight below 25,000 feet is impractical, engine operation above 25,000 feet with gravity fuel flow is possible at reduced power settings. If a reduced power setting is also impractical, use crossfeed operation to ensure boost pump pressure and minimize the possibility of fuel flow interruption. Monitor the fuel balance and descend as soon as practical. Flight at lowest practical altitude and reduced power settings will minimize probability of fuel flow interruptions.

DUAL ENGINE FAILURE AT LOW ALTITUDE

If both engines fail during flight at low altitude and with sufficient airspeed, the aircraft should be zoomed (approximately 20° nose up attitude) to exchange airspeed for altitude and to allow additional time to accomplish subsequent emergency procedures. ALTERNATE AIRSTART/LOSS OF THRUST (LOW ALTITUDE) should be attempted immediately upon detection of dual engine flameout. If the decision is made to eject, ejection should be accomplished during the zoom while the aircraft is in a nose high positive rate of climb. It is imperative that the ejection sequence be initiated prior to reaching a stall or rate of sink.

3-44

WARNING

Do not delay ejection by attempting airstarts at low altitude if below the optimum airstart airspeed and below 2000 feet AGL.

ALTERNATE AIRSTART/LOSS OF THRUST (LOW ALTITUDE)

The alternate airstart is primarily designed for use at low altitude when thrust requirements are critical. An airstart may be accomplished by advancing the throttle to MAX range. This energizes normal and afterburner ignition for approximately 30 seconds. If the throttle remains in MAX and the engine does not start after 30 seconds, additional starts may be attempted by retarding the throttle out of MAX range to reset the circuit and again advancing the throttle into MAX range to reactivate the ignition cycle. After engine start, the throttle may be left in MAX range if afterburner operation is desired.

1. THROTTLE(S) - MAX

WARNING

If throttle(s) is/are already in MAX, recycle MIL to MAX.

2. SPEED BRAKE - CONFIRM CLOSED

WARNING

The pilot must ensure the speed brake is not unintentionally extended from either cockpit when the throttle is advanced. The close proximity of the speed brake switch to the pilot's knee makes unintentional activation likely.

With dual engine failure, BATTERY switch must be ON to provide ignition. If AC is regained, avionics re-initializes and starts IBIT.

(BEFORE PMP)

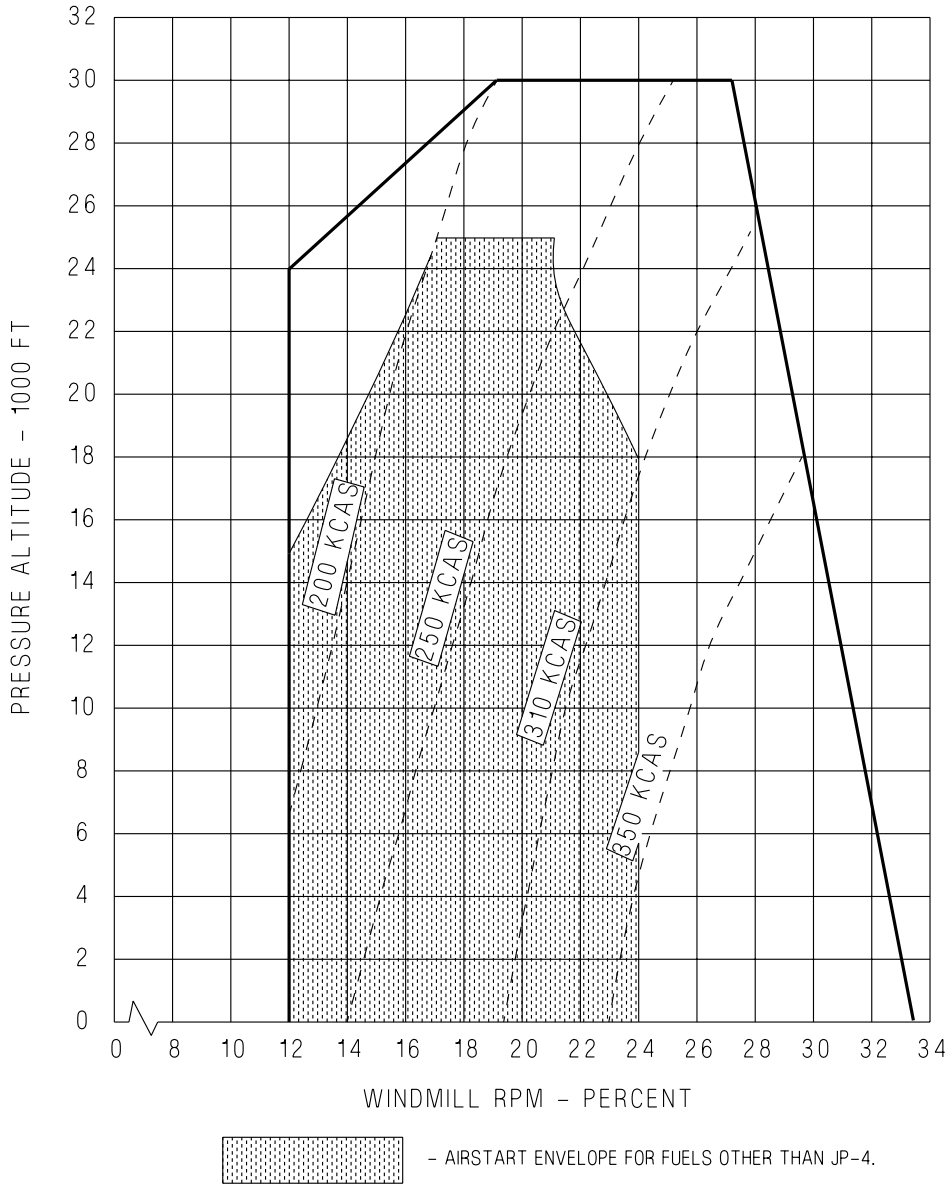

T38002-17-1-020

Figure 3-5. Airstart Envelope (Sheet 1 of 2)

T.O. 1T-38C-1

(AFTER PMP)

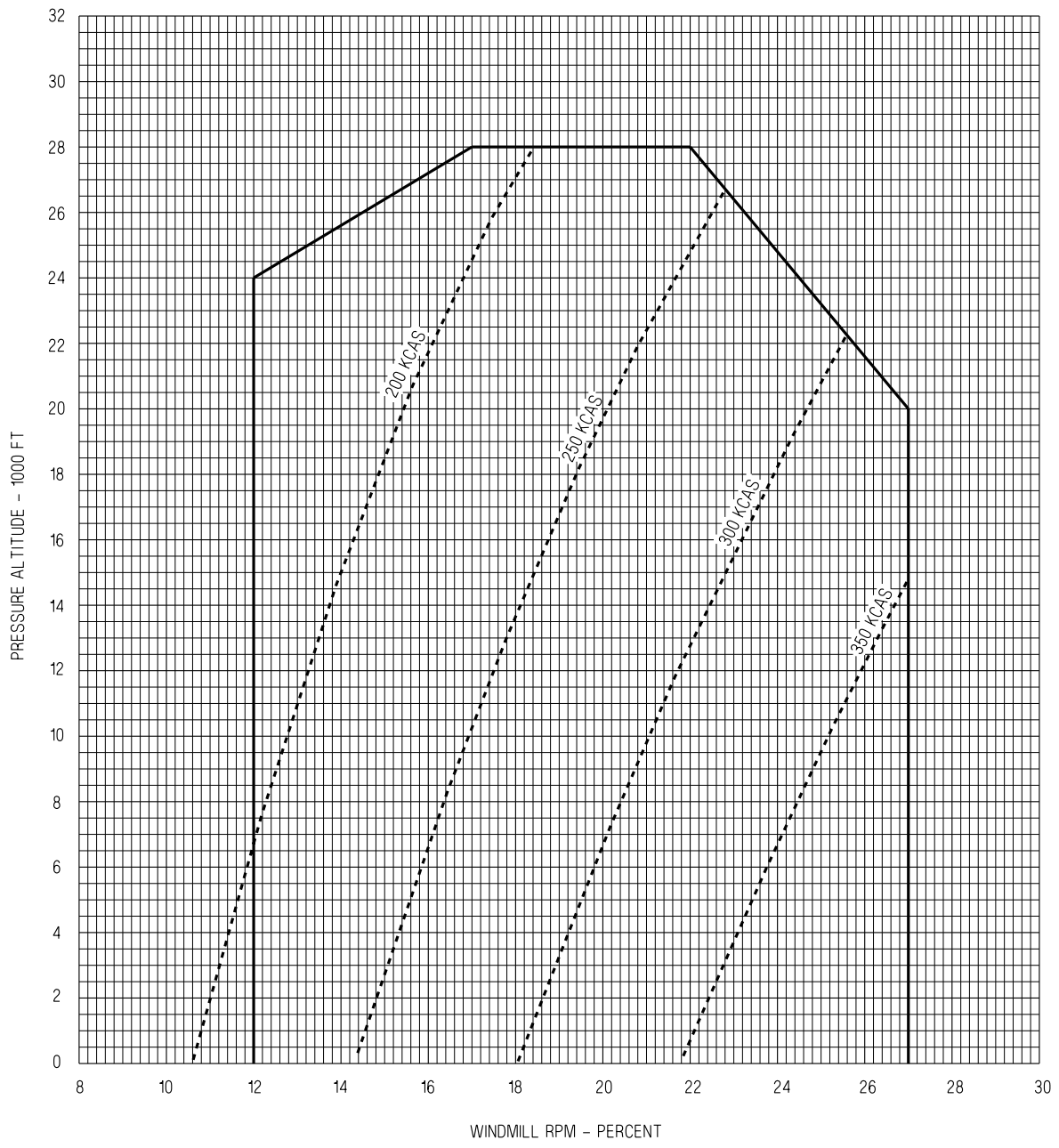

T38002-298-1-020

Figure 3-5. Airstart Envelope (Sheet 2)

3-46

COMPRESSOR STALL

Malfunction indications are as follows:

- a. Low altitude and high airspeed - pop, bang or buzz; rapid RPM drop or high EGT.
- b. High altitude and low airspeed - audible chug or pop, decreasing RPM and decreasing EGT.
 1. Throttle - IDLE

NOTE

Rapidly retarding the throttle to IDLE and immediately pushing the engine start button may permit the engine to recover and prevent complete flameout.

2. ENGINE START button - PRESS
3. Increase/decrease airspeed as necessary.

NOTE

If engine damage is suspected, advance throttle above IDLE only if required.

4. EGT/RPM - MONITOR

If engine will not restart or recover -

5. Throttle gate - DISENGAGE
6. Throttle - OFF

NOTE

- After a compressor stall, the engine may not recover to the full range of operation. If normal indications can be achieved for a given power setting, the engine should not be shutdown unless other circumstances dictate.
- If the engine is shut down, an airstart may be attempted as applicable.
- The EED fuel flow indicator(s) on the inoperative engine may read as high as 60 PPH.

FLIGHT CONTROL EMERGENCIES

ABRUPT AND UNCOMMANDED AIRCRAFT PITCH-UP, FLAPS EXTENDED

If an abrupt aircraft pitch-up occurs while the flaps are extended, flap-slab interconnect failure should be suspected. If the failure occurs at conventional traffic pattern airspeeds and configurations, the aircraft, in addition to pitching up, will exhibit heavy buffeting, wing rock and stall immediately. If this occurs in the traffic pattern, proceed as follows.

1. Control stick - FULL FORWARD TO ARREST PITCH RATE

WARNING

- If takeoff is made with interconnect system failure, a lighter than normal stick force and reduced amount of stick travel will be required for rotation. Until the flaps are retracted, significant forward stick pressure will be required to keep the pitch attitude from increasing.
- If interconnect cable failure occurs after flaps are down 60% or more, a sudden pitch-up will occur and the aircraft will stall instantaneously. Full forward stick will be necessary to arrest the rate of pitch-up and the pilot must take corrective action within 3 seconds to ensure recovery without a loss of altitude.

2. Throttles - MAX
3. FLAPS - 60%

WARNING

Interconnect failure can occur even after flaps have stabilized in a given position. If failure occurs while flying at final approach airspeed, initially repositioning the flaps to 60% reduces stick forces and provides the best chance of recovery. Do not retract the flaps to the no flap position until the aircraft accelerates above no flap flying airspeed.

4. Landing gear - UP WHEN CONTINUED FLIGHT IS ASSURED
5. FLAPS - UP WHEN THE AIRCRAFT ACCELERATES ABOVE NO FLAP FLYING AIRSPEED
Be prepared to relax forward stick force as flaps are retracted.

NOTE

With the flaps set at 60% or more, the required stick position will be beyond the forward trim cutout limit.

6. Land with flaps retracted.

NOTE

- The amount of horizontal tail authority will be that available with zero flaps regardless of the actual flap setting.
- Moderate to heavy stick forces will be present until the flaps are retracted.

A no flap landing is preferred. However, if landing conditions require the use of some flaps to reduce touchdown speeds and landing distance, a flap setting between 30-45% will provide limited, but adequate, nose down control authority and manageable stick forces. Fly AOA on speed indications on final and use caution to avoid over rotation in the flare as forward stick pressure is relaxed.

UNCOMMANDED SMOOTH PITCH-UP DURING FLAP EXTENSION

Failure with flaps up: As flaps are extended, a smooth but definite pitch-up will occur. Stick will be abnormally forward but forces will be controllable. In this situation, retract flaps and make a no flap landing.

1. Flaps - REPOSITION TO UP

NOTE

It is easy to confuse trim failure with flap-slab interconnect failure. Careful analysis of configuration and control movements at the time of occurrence are essential.

2. Throttles - AS REQUIRED TO MAINTAIN ABOVE NO FLAP FLYING AIRSPEED
3. Land with flaps retracted.

If a flap setting less than 60 % is used, fly AOA on speed indications on final. Greater than 60 %, use normal pattern airspeeds.

If the interconnect system failed with the flaps retracted, a no flap landing is preferred. However, if landing conditions require the use of some flaps to reduce landing distance and improve aerodynamic braking, a flap setting between 30-45 % will provide limited but adequate nose down control authority and manageable stick forces. Fly AOA on speed indications on final and use caution to avoid over rotation in the flare as forward stick pressure is relaxed.

FLAP ASYMMETRY

WARNING

High speed flap deflection can result in an instantaneous failure of one or both flaps. If one flap fails, the sudden asymmetric condition will result in a severe coupled roll and yaw possibly associated with high negative G's. Immediately return the flap lever to the UP position to ensure recovery.

NOTE

Detection of unintentional flap deployment at high speed is critical to avoiding a flap failure. Upon flap deflection, there will be an uncommanded pitch down associated with a noise of rushing air and possible buffet. If this condition occurs, immediately return the flap lever to the UP position.

If lateral rolling and yawing is experienced during operation of the flaps or while the flaps are extended, an asymmetric flap condition probably exists. Asymmetry may occur from physical binding or only one flap tracking when the flaps are actuated resulting in a gradually increasing uncommanded roll and yaw as the flap extends or retracts. This is readily detected and can be corrected by reversing the direction of flap movement.

If a flap setting less than 60 % is used, fly AOA on speed indications on final. Greater than 60 %, use normal pattern airspeeds.

A more serious control situation arises when the asymmetry occurs following an instantaneous failure within the flap system. The severity is dependent on airspeed and flap position (in transit or fully extended) at the moment of failure. The situation is characterized by an immediate uncommanded yaw and rapid roll. Sufficient control authority is available to counteract the yaw and roll at pattern airspeeds.

If either condition occurs, use the following procedure.

1. Throttles - MAX
2. FLAPS lever - ACTUATE TO ELIMINATE OR MINIMIZE THE FLAP ASYMMETRIC CONDITION
3. Airspeed - ABOVE 180 KCAS
4. AUX FLAP switch - EMER

NOTE

In the EMER position, flap settings can be set to any intermediate position to eliminate the asymmetric condition.

If asymmetry persists -

5. Airspeed - MAINTAIN 20 KCAS ABOVE FINAL APPROACH AND TOUCHDOWN SPEEDS. DO NOT TOUCHDOWN BELOW 165 KCAS.

NOTE

If the asymmetric condition cannot be corrected and conditions permit, land from a straight-in approach.

T.O. 1T-38C-1

FLAP HORIZONTAL TAIL LINKAGE MALFUNCTION

If the interconnect system fails with the flaps retracted a smooth but definite pitch-up will occur as flaps are lowered. This pitch-up can be controlled. As flaps approach 60%, the control stick must be positioned very close to the forward stop to maintain controlled flight. Heavy forward stick forces will be required which cannot be completely trimmed out, as the stick will be forward of the trim cut out limit. Although the aircraft may be flown in level flight in this configuration, very little nose down control authority is available to maneuver the aircraft. If such a condition is encountered, retract the flaps and make a no flap landing whenever possible. A no flap landing is preferred. However, if landing conditions require the use of some flap extension to reduce touchdown speed and improve aerodynamic braking, a flap setting of between 30-45% will provide limited but adequate nose down control authority and manageable forward stick forces. Fly a straight-in approach and be careful to avoid over-rotation as forward stick pressure is relaxed to initiate the landing flare. Final approach and touchdown airspeed will be between the normal and no flap computed speeds. Maintain an AOA on-speed indication on final approach.

If the interconnect system fails with flaps lowered any amount, the horizontal tail will instantly reposition to the zero flap setting and all flight control compensation is removed. This will always result in an abrupt and uncommanded aircraft pitch-up. The severity of the pitch-up is directly dependent on the airspeed and flap setting at the moment of failure. The stick must be positioned forward (to within 1 inch of the forward stop) to obtain controlled level flight. Furthermore, the available nose down slab deflection is greatly reduced and the stick must be positioned full forward to arrest the initial pitch-up rate caused by the interconnect failure. These forward stick forces cannot be trimmed out. When a safe airspeed and altitude are obtained, positioning the flaps up will return flight control and handling characteristics to normal. Flight tests have verified that at speeds as low as touchdown airspeeds, this type of failure is recoverable and that a controlled go-around is possible. However, the recovery procedure requires immediate pilot response and must be precisely applied within 3 seconds to ensure recovery without a loss of altitude. Recovery from an interconnect failure during the final approach or touchdown phase

requires the use of full afterburners and the immediate retraction of flaps to 60% to eliminate the excess drag caused by full flaps.

WARNING

If takeoff is made with interconnect system failure, a lighter than normal stick force and reduced amount of stick travel will be required for rotation. Until the flaps are retracted, significant forward stick pressure will be required to keep the pitch attitude from increasing.

NOTE

It is easy to confuse trim failure with flap-slab interconnect failure. Careful analysis of configuration and control movements at the time of occurrence are essential.

TRIM MALFUNCTION

If an aircraft trim malfunction results in either full nose up or full nose down trim, the stick force needed to position the horizontal stabilizer may be several times greater than expected. Runaway trim effects may be minimized by immediately attempting to trim opposite the undesired stick forces to stop or reverse the horizontal tail trim movement. If the trim malfunction results in excessive nose down trim loads, increasing airspeed may reduce required stick forces to maintain level flight. If the trim malfunction results in excessive nose up trim loads, decreasing airspeed may reduce required stick forces to maintain level flight.

NOTE

The takeoff trim system is independent, and depending on trim position, may help relieve some stick pressure near approach airspeeds.

3-50

STABILITY AUGMENTOR MALFUNCTION

The stability augmentor yaw system can fail with a resulting rudder deflection of 2°. This deflection will cause a yaw and resulting moderate rudder roll. At high speed/high AOA the roll rate is greater and the yaw is less noticeable. Opposite rudder will immediately neutralize the yaw and roll. If yaw oscillations are induced by the stability augmentor, the switch should be set to OFF. Flashing AVIONICS remains until ACK is pressed, but PFL remains until YSAS is reengaged.

Malfunction indications are as follows:

- a. Yaw and moderate rudder roll.
- b. Chattering rudder pedals.
- c. At high speed and high AOA, the roll rate is greater and the yaw is less noticeable.

1. AOA - REDUCE (IF ABLE)
2. Apply opposite rudder and aileron (as required to control yaw and roll).
3. Yaw DAMPER switch - OFF



If the DAMPER switch is found OFF during flight, attempt to reset it to YAW one time. If it stays in YAW continue the mission. If it immediately returns to OFF and aircraft response to slight rudder inputs is normal, continue the mission with SAS off.

4. STABILITY AUGMENTOR circuit breaker - PULL (RCP LEFT CONSOLE, IF MALFUNCTION CONTINUES)



If response to rudder inputs is not normal, erroneous corrections or spurious rudder activations may occur. If flying dual, pull the STABILITY AUGMENTOR circuit breaker (RCP left console) and continue the mission. If flying solo, terminate the mission as soon as practical using a straight-in approach to landing. If the landing is questionable due to rudder oscillations, set EGI switch to OFF to remove electrical power from SAS.

If solo, and landing is questionable due to oscillations -

5. EGI - OFF

RUDDER SYSTEM MALFUNCTIONS SEE SS-1

The rudder system has several failure modes. Pilots must evaluate the severity of any abnormal yaw and/or roll to determine the required course of action.

If the rudder force producer spring fails, it may cause the rudder to jam. Alternatively, the rudder pedals may not center normally, and the rudder will deflect appropriate to rudder pedal displacement. The rudder will lack its artificial feel, and may appear to be more sensitive to input than normal. Pilot action in this case should be to displace the rudder pedals to minimize yaw and/or roll, and minimize rudder input.

T.O. 1T-38C-1

The aircraft should be controllable through the landing phase; however, as AOA increases and the rudder becomes more effective, even small rudder inputs by the pilot may cause yaw and/or roll excursions.

An additional rudder failure mode may result in a full 30° of rudder displacement. Indications of this failure mode will be a smooth, increasing yaw and resulting roll. Opposite rudder pedal inputs will have no effect on rudder deflection. As the yaw angle increases, the engines may stall, stagnate, or flame out. Immediate aileron inputs and reduction of AOA may control the yaw at first, but aircraft control is not possible at normal angles of attack due to increased rudder roll authority. Eject as soon as practical after confirming that full opposite rudder/aileron inputs and reduction of AOA cannot control the yaw/roll.

CONTROLLABILITY CHECK /STRUCTURAL DAMAGE

If structural damage or a flight control malfunction occurs or is suspected in flight, a decision must be made whether to abandon the aircraft or attempt a landing. The purpose of this check is to determine if the aircraft can be landed and, if so, to determine what configuration is best for landing. Normally, the aircraft would be configured with gear and full flaps and slowed to a minimum controllable airspeed or normal touchdown speed, whichever is higher. If unable to achieve normal configuration and airspeed, the configuration and airspeed should be adjusted to accomplish a landing.

If a touchdown speed greater than 200 KCAS is computed, another controllability check at a lower fuel weight should be considered. Touchdowns greater than 200 KCAS should not be attempted as the nose gear will touch first increasing the possibility of a high speed Pilot Induced Oscillation (PIO). Once a touchdown speed is computed, do not change the speed due to fuel weight lost enroute to the airfield.

With any structural damage, do not aerobrake. Hold the landing attitude until the loss of slab authority and then cautiously apply the wheel brakes. Not aerobraking could increase normal landing distance by as much as 50%.

1. COMM ANTENNA switch - LOWER (IF APPLICABLE)



Damage to or loss of the upper portion of the vertical tail will result in the loss of the upper UHF antenna and VOR/ILS.

2. Notify appropriate ground agency of intentions.
3. Climb to at least 15,000 feet AGL (if practical) at a controlled airspeed.
4. Simulate a landing approach.



Consider using the AUX FLAP switch to reposition the flaps. If damage to the flaps or flap actuating mechanism is known or suspected, do not reposition the flaps.

5. Determine airspeed at which aircraft becomes difficult to control.

NOTE

Slow to minimum controllable airspeed or touchdown speed, whichever occurs first. As a guide, if you have to deflect the stick more than 3/4-stick travel to maintain level unaccelerated flight, you have reached your minimum controllable speed. Touchdown speed is generally plus or minus 5 knots of level flight stall speed. In no case allow airspeed to decrease below touchdown speed.

If a touchdown speed greater than 200 KCAS is computed, another controllability check at a lower fuel weight should be considered. Touchdowns greater than 200 KCAS should not be attempted as the nose gear will touch first increasing the possibility of a high speed PIO. Once a touchdown speed is computed, do not change the speed due to fuel weight lost enroute to the airfield.

6. Do not change aircraft configuration.
7. Maintain at least 20 KCAS above minimum controllable airspeed during descent and landing approach.

8. Fly a power-on straight-in approach requiring minimum flare. Plan to touchdown at 10 knots above either normal touchdown speed or minimum control speed whichever, is higher.

WARNING

Touchdowns as high as 200 KCAS are possible. High speed touchdown initially limits the effectiveness of aerodynamic and/or wheel braking.

With any structural damage, do not aerobrake. Hold the landing attitude until the loss of slab authority and then cautiously apply the wheel brakes. Not aerobraking could increase normal landing distance by as much as 50 %.

MISCELLANEOUS EMERGENCIES

BRAKE SYSTEM MALFUNCTION (FLUID VENTING)

Failure of certain components of the wheel brake master cylinders or brake lines located within the pressurized area of the cockpit may cause brake fluid (red) present/visible on the right side of aircraft below/aft of the RCP canopy rail to vent overboard through the brake fluid reservoir. If allowed to continue, all brake fluid could be forced overboard. With no other known malfunction, plan to land in the center of the runway.

If brake fluid venting is suspected or detected -

1. Descend to 25,000 feet or below, if practical.
2. CABIN PRESS switch - RAM DUMP, BELOW 25,000 FEET
3. Land at lowest practical gross weight.

WARNING

If brake failure is encountered on landing roll, braking action may be regained by repeatedly pumping the brakes. The pedals should be released to the full up position between strokes.

CAUTION

Do not pump the brakes in flight as this action could introduce air into the brake system which could result in complete brake failure.

EJECTION VS FORCED LANDING

Ejection is preferable to landing on an unprepared surface. Do not land the aircraft with both engines flamed out.

DITCHING

Ejection is to be accomplished in preference to ditching the aircraft.

EJECTION PROCEDURE (BEFORE T.O. 1T-38C-546)

Escape from the aircraft should be made with the ejection seat, using the sequence shown in Figure 3-6. After ejection, the safety belt automatically opens and a man-seat separation system forcibly separates the crewmember from the ejection seat, Figure 3-7. A rapid deployment escape system is provided to improve low-altitude escape capability. The zero-delay lanyard, if present on the parachute, may be disconnected for completely controlled ejections if time and altitude permit. If the zero-delay lanyard is present, it should be connected in accordance with present directives. However, if it is apparent the crewmember is going to eject at more than 2000 feet AGL in a controlled condition, the zero-delay lanyard should be disconnected to reduce chances of seat/chute/crewmember involvement. There is no evidence to indicate that one should attempt to connect the zero-delay lanyard after deciding to eject. The time loss in connection is greater than any advantages which may be gained.

WARNING

- Do not delay ejection below 2000 feet AGL in futile attempts to start the engines or for other reasons that may commit you to an unsafe ejection or a dangerous flameout landing. Accident statistics emphatically show a progressive decrease in successful ejections as altitude decreases below 2000 feet above the terrain.
- Under uncontrollable conditions, eject at least 15,000 feet above the terrain whenever possible.
- If the aircraft is not controllable, ejection must be accomplished at whatever speed exists, as this offers the only opportunity for survival. At sea level, wind blasts and deceleration will exert medium forces on the body up to approximately 450 KCAS (0.7 Mach), severe forces causing flailing and skin injuries between 450 (0.7 Mach) and 600 KCAS (0.9 Mach) and excessive forces

above 600 KCAS (0.9 Mach). As altitude increases, the speed ranges of the injury-producing forces will be a function of the Mach number.

During any low-altitude ejection, the chances for successful ejection can be greatly increased by pulling up to exchange airspeed for altitude if airspeed permits. See Figure 3-8 for safe minimum ejection altitude versus sink rate and Figure 3-9 for ejection altitude versus blank/dive angle. See Figure 3-10 for T-38 ejection injury risk parameters. If rate of climb cannot be accomplished, level flight ejection should be accomplished immediately to avoid ejection with a sink rate. The automatic safety belt must not be opened before ejection, regardless of altitude. If the safety belt is opened manually, the automatic feature of the parachute is eliminated.

WARNING

If the aircraft is not controllable, ejection must be accomplished at whatever speed exists, as this offers the only opportunity for survival. At sea level, wind blasts and deceleration will exert medium forces on the body up to approximately 450 KCAS (0.7 Mach), severe forces causing flailing and skin injuries between 450 (0.7 Mach) and 600 KCAS (0.9 Mach) and excessive forces above 600 KCAS (0.9 Mach). As altitude increases, the speed ranges of the injury-producing forces will be a function of the Mach number.

CAUTION

Ejection should be accomplished while in a positive rate of climb with the aircraft approximately 20° nose-up and before the start of any sink rate. Ejection while the nose of the aircraft is above the horizon and in a positive rate of climb will result in a more nearly vertical trajectory for the seat, thus providing more altitude and time for seat separation and parachute deployment.

The emergency MINIMUM ejection conditions, based on a level altitude with no sink rate are as follows:

BA-22 or BA-25 parachutes with 0.25-second delay opening, or BA-22 parachute with zero delay lanyard ATTACHED	} Ground Level at 50 KCAS
BA-22 parachute with zero delay lanyard NOT ATTACHED (1-second delay opening)	} 100 feet AGL

WARNING

The foregoing information is based on numerous rocket-sled tests using the ballistic rocket ejection catapult. No safety factor is provided for equipment malfunction. Since survival from an extremely low altitude ejection depends primarily on the aircraft attitude and altitude, the decision to eject must be left to the discretion of the pilot. Factors such as G-loads, high sink rates, and aircraft attitudes other than level or slightly nose high will decrease chances for survival. Aircraft rolling, pitching and yawing moments, such as those found in a loss of control, increase the chance of seat-crew contact and parachute entanglement regardless of ejection altitude. The emergency minimum ejection conditions (ground level and 50 KCAS) are provided only to show that zero altitude ejection can be accomplished in case of an emergency which would require immediate ejection. It must not be used as a basis for delaying ejection when above 2000 feet.

The emergency MAXIMUM ejection airspeeds from sea level thru 14,000 feet are as follows:

BA-22 or BA-25 parachutes with 0.25-second delay opening	500 KCAS
BA-22 parachute with zero delay lanyard ATTACHED	400 KCAS
BA-22 parachute with zero-delay lanyard NOT ATTACHED (1 second delay opening)	550 KCAS

T.O. 1T-38C-1

BEFORE EJECTION

If time and conditions permit -

1. Notify crewmember of decision to eject.
2. Select IFF to EMERGENCY and, if not in radio contact with appropriate agencies, turn radio to GUARD and transmit MAYDAY.
3. Turn aircraft toward uninhabited area.
4. Stow all loose equipment.
5. Survival kit (AUTO/MANUAL) - AS REQUIRED
6. (High altitude) Actuate emergency oxygen cylinder.
7. Disconnect oxygen hose and g-suit, tighten oxygen mask and chin strap securely (well beyond comfortable range), and lower and lock visor(s). Under controlled conditions above 2000 feet AGL, disconnect and stow zero-delay lanyard (if applicable).
8. Attain proper airspeed, altitude, and attitude.

WARNING

Ejection while the nose of the aircraft is above the horizon and in a positive rate of climb will result in a more nearly vertical trajectory for the seat, thus providing more altitude and time for seat separation and parachute deployment. If a climb rate cannot be established, ejection should be accomplished immediately to avoid ejection with a sink rate. Seat minimums assume wings level flight with no sink rate.

9. Assume proper position.

WARNING

Sit erect, head firmly against the headrest, feet held back against the seat. Position elbows close to body within elbow guards to protect elbows when leg braces are raised, and during ejection.

EJECTION

1. HANDGRIPS - RAISE

WARNING

The crewmember in the rear cockpit should eject first if altitude permits. This will prevent possible injury from front seat rocket blast. Maintaining aircraft control may require use of only one hand to initiate the ejection sequence.

AFTER EJECTION

Immediately after ejection the following procedures apply:

1. Safety belt - ATTEMPT TO OPEN MANUALLY
Attempt to manually open the safety belt as a precaution against the belt failing to open automatically.
2. Safety belt released - ATTEMPT TO SEPARATE FROM SEAT
A determined effort must be made to separate from the seat to obtain full parachute deployment at maximum terrain clearance. This is extremely important for low altitude ejections.
3. If safety belt opened manually - IMMEDIATELY PULL PARACHUTE ARMING LANYARD BALL
If flying over high terrain, consideration should be given to pulling the ripcord handle even if above automatic parachute opening altitude.
4. Survival kit - DEPLOY AFTER PARACHUTE OPENING.

WARNING

Refer to T.O. 14D1-2-1, section III for various landing situations (i.e., water, tree, power line, etc.).

(BEFORE T.O. 1T-38C-546)

WARNING

ASSUME PROPER POSITION

- SIT ERECT, HEAD FIRMLY AGAINST HEADREST, FEET HELD BACK AGAINST THE SEAT.
- POSITION ELBOWS CLOSE TO BODY WITHIN ELBOW GUARDS, TO PROTECT ELBOWS WHEN LEG BRACES ARE RAISED, AND DURING EJECTION.
- THE CREW MEMBER IN REAR COCKPIT SHOULD EJECT FIRST IF ALTITUDE PERMITS. THIS WILL PREVENT POSSIBLE INJURY FROM FRONT SEAT ROCKET BLAST.
- MAINTAINING AIRCRAFT CONTROL MAY REQUIRE USE OF ONE HAND TO INITIATE THE EJECTION SEQUENCE.
- THE EJECTION SEAT IS CURRENTLY QUALIFIED AND CERTIFIED FOR AIRCREW MEMBER WEIGHING IN THE RANGE OF 140 - 211 POUNDS. AIRCREWS OUTSIDE THIS WEIGHT RANGE HAVE AN INCREASED PROBABILITY OF INJURY DURING THE EJECTION PROCESS.

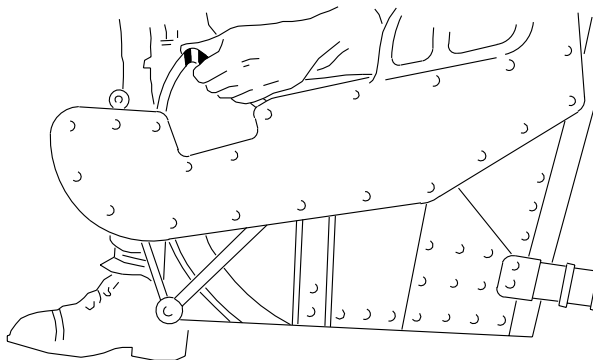
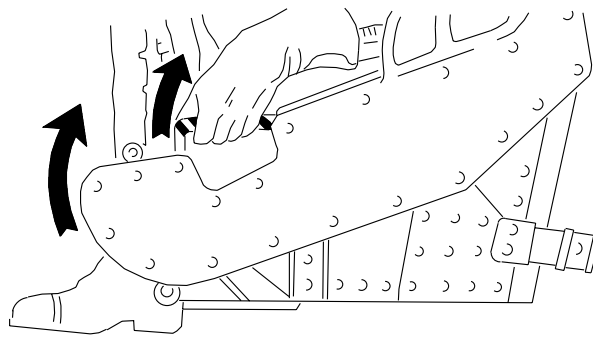
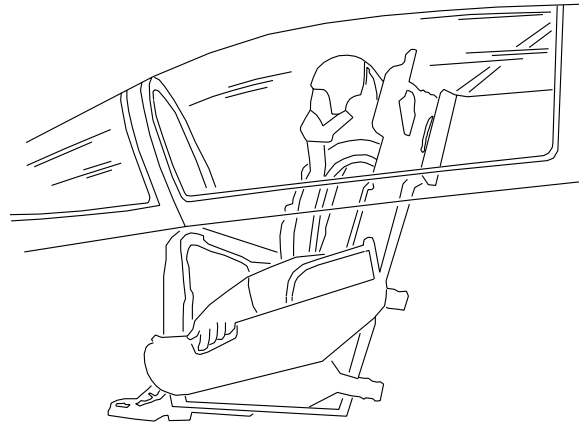

1 HANDGRIPS - RAISE

T38002-18-1-020

Figure 3-6. Ejection

T.O. 1T-38C-1

(BEFORE T.O. 1T-38C-546)

NOTE

- TIME FROM RAISING HANDGRIPS TO FULL 0.25 SECOND DELAY PARACHUTE DEPLOYMENT IS 3.42 SECONDS (APPROX) AT AN EJECTION AIRSPEED OF 160 KNOTS. VARIABLES SUCH AS LOWER AIRSPEEDS AND THE ATTITUDE OF THE PILOT AT TIME OF PACK OPENING CAN INCREASE PARACHUTE DEPLOYMENT TIME.
- TIME TO FULL PARACHUTE DEPLOYMENT IS THE SAME FOR BOTH SEATS.

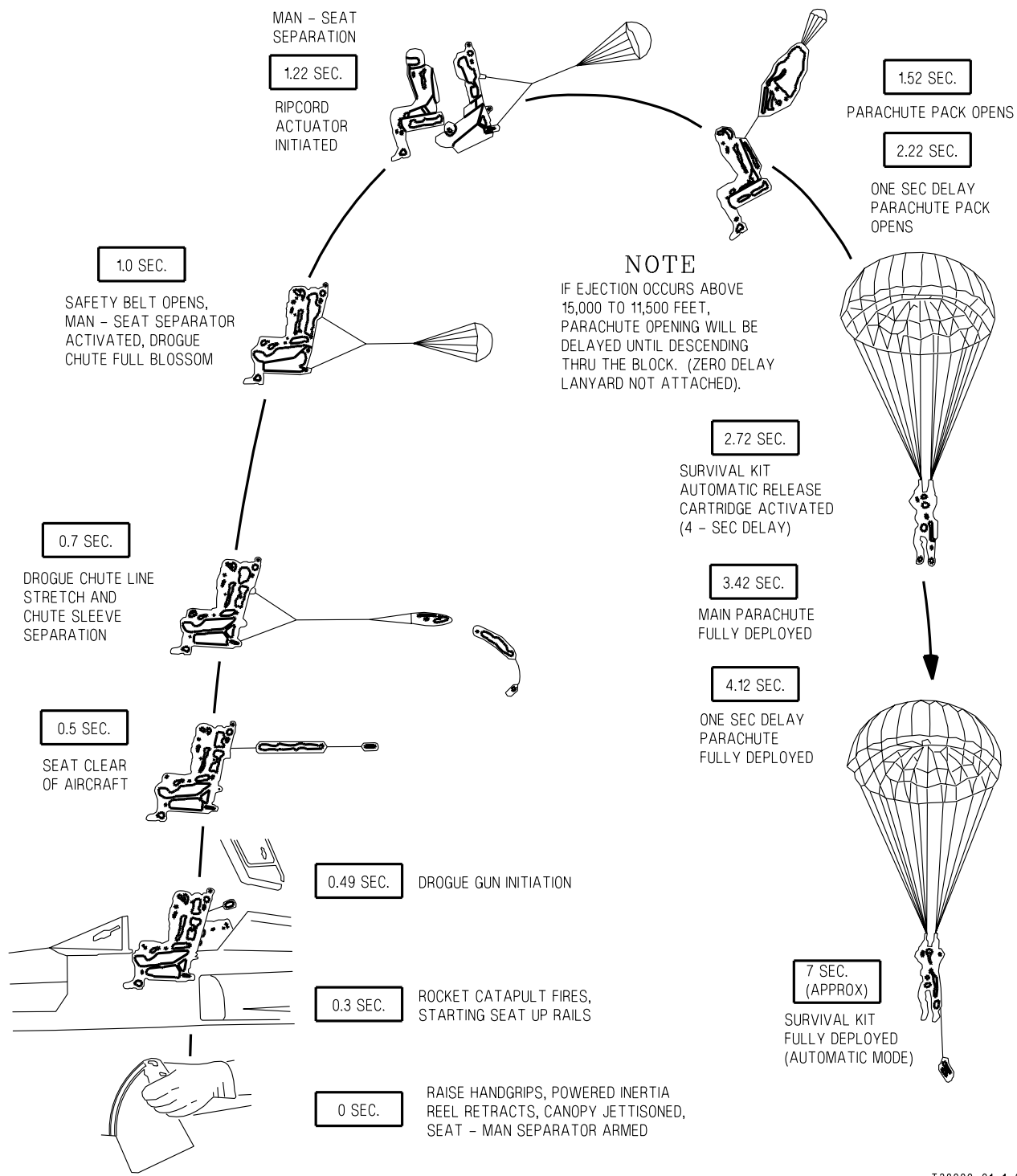

T38002-21-1-020

Figure 3-7. Ejection Sequence

0.25 SECOND DELAY OPENING PARACHUTE OR ZERO DELAY LANYARD ATTACHED

WARNING

- NOTES**
- ASSUMED REAR SEAT EJECTS FIRST, FOLLOWED IN 0.75 SECOND BY FRONT SEAT.
 - IF THE WINGS ARE NOT LEVEL, BANK ANGLE EFFECTS (FIGURE 3-5) MUST BE ADDED.
 - BOTH EJECTION SEATS HAVE THE SAME EJECTION CAPABILITY.

- THE MINIMUM EJECTION ALTITUDES SHOW SEAT CAPABILITY (WITH 2-SECOND REACTION TIME) AS AFFECTED BY AIRCRAFT SINK RATE. THE MINIMUM ALTITUDES DO NOT PROVIDE ANY SAFETY FACTOR FOR EQUIPMENT MALFUNCTION, DELAY IN SEPARATING FROM THE SEAT, AND AIRCRAFT DIVE AND BANK ANGLES ABOVE 2000 FEET TERRAIN CLEARANCE.
- THE MINIMUM EJECTION ALTITUDES SHALL NOT BE USED AS THE BASIS FOR DELAYING EJECTION WHEN ABOVE 2000 FEET TERRAIN CLEARANCE.

CONDITIONS

AIRSPEED AT EJECTION - 150 KIAS
 WINGS LEVEL - SLIGHT NOSE-UP ATTITUDE
 2-SECOND REACTION TIME

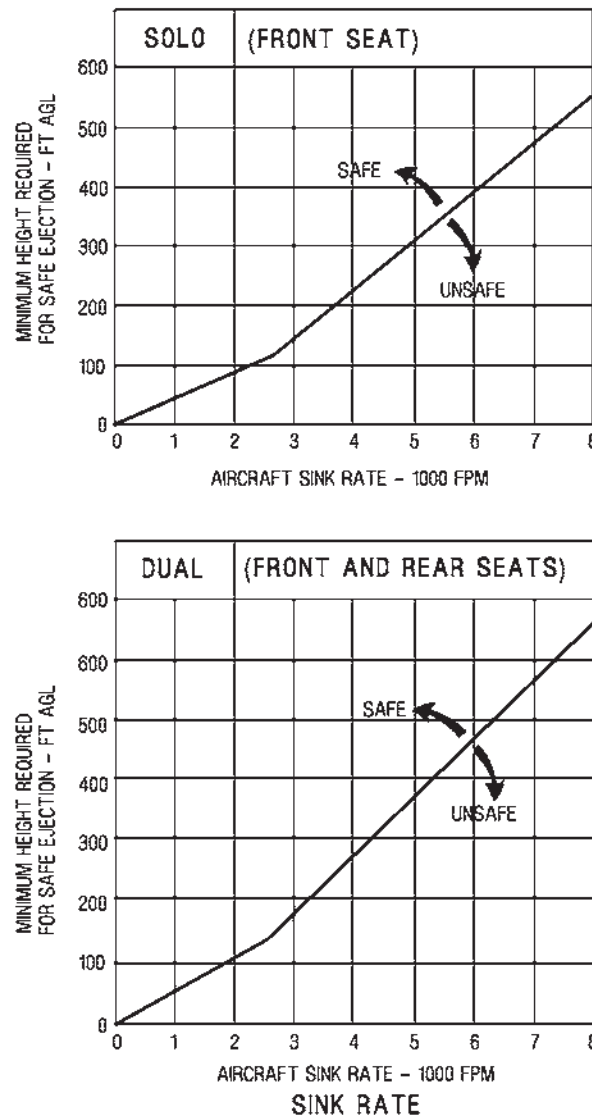

T38002-19-1-020

Figure 3-8. Ejection Altitude vs Sink Rate

(BEFORE T.O. 1T 38C 546)

0.25 SECOND DELAY OPENING PARACHUTE OR ZERO DELAY LANYARD ATTACHED.

WARNING

- EJECTIONS ABOVE EACH TIME REACTION, DIVE ANGLE, OR BANK ANGLE LINE ARE SAFE FOR GIVEN CONDITIONS.
- EJECTIONS BELOW EACH LINE ARE UNSAFE.

BANK ANGLE

CONDITION
CONSTANT ALTITUDE

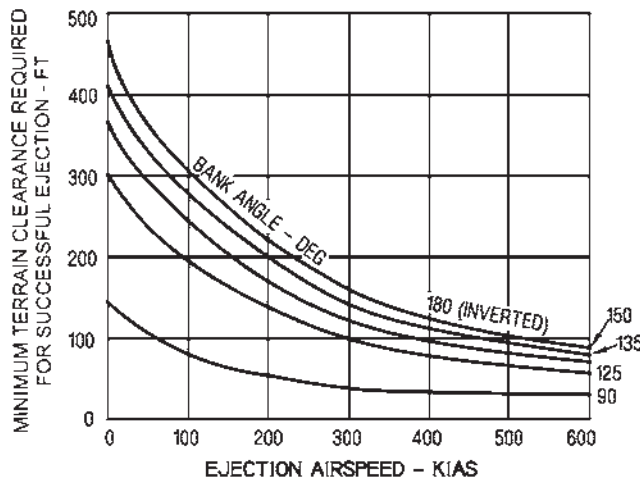

- NOTES**
- BANK ANGLES UP TO 60° ARE SAFE FOR LEVEL FLIGHT AT ALL AIRSPEEDS UP TO 500 KIAS WITH 0.25 SECOND DELAY OPENING PARACHUTE OR 400 KIAS WITH ZERO DELAY LANYARD ATTACHED.
 - 3 KNOTS MUST BE ADDED FOR AN EQUIVALENT CAS AIRSPEED.

DIVE ANGLE

CONDITIONS
WINGS LEVEL
2-SECOND REACTION TIME

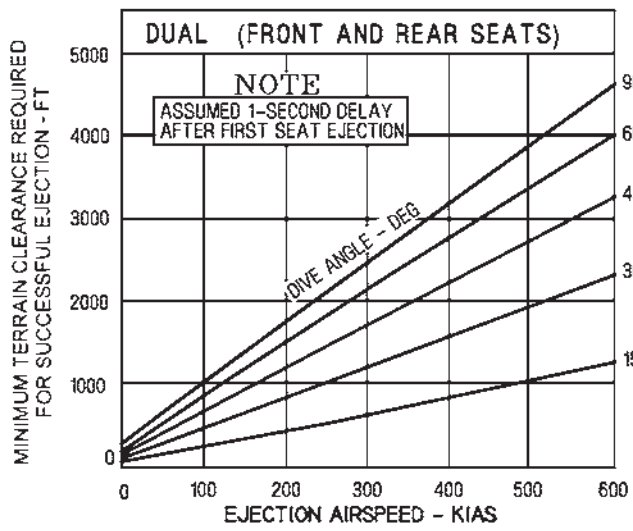
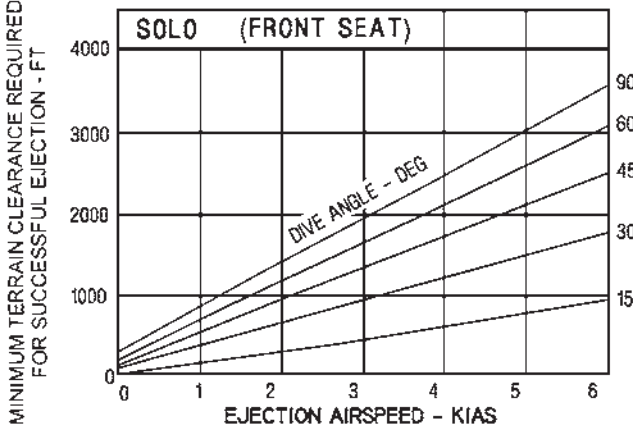

- NOTES**
- IF THE WINGS ARE NOT LEVEL, BANK ANGLE EFFECTS MUST BE ADDED.
 - 3 KNOTS MUST BE ADDED FOR AN EQUIVALENT CAS AIRSPEED.

T38002-20-1-021

Figure 3-9. Ejection Altitude vs Bank/Dive Angle

(BEFORE T.O. 1T-38C-546)

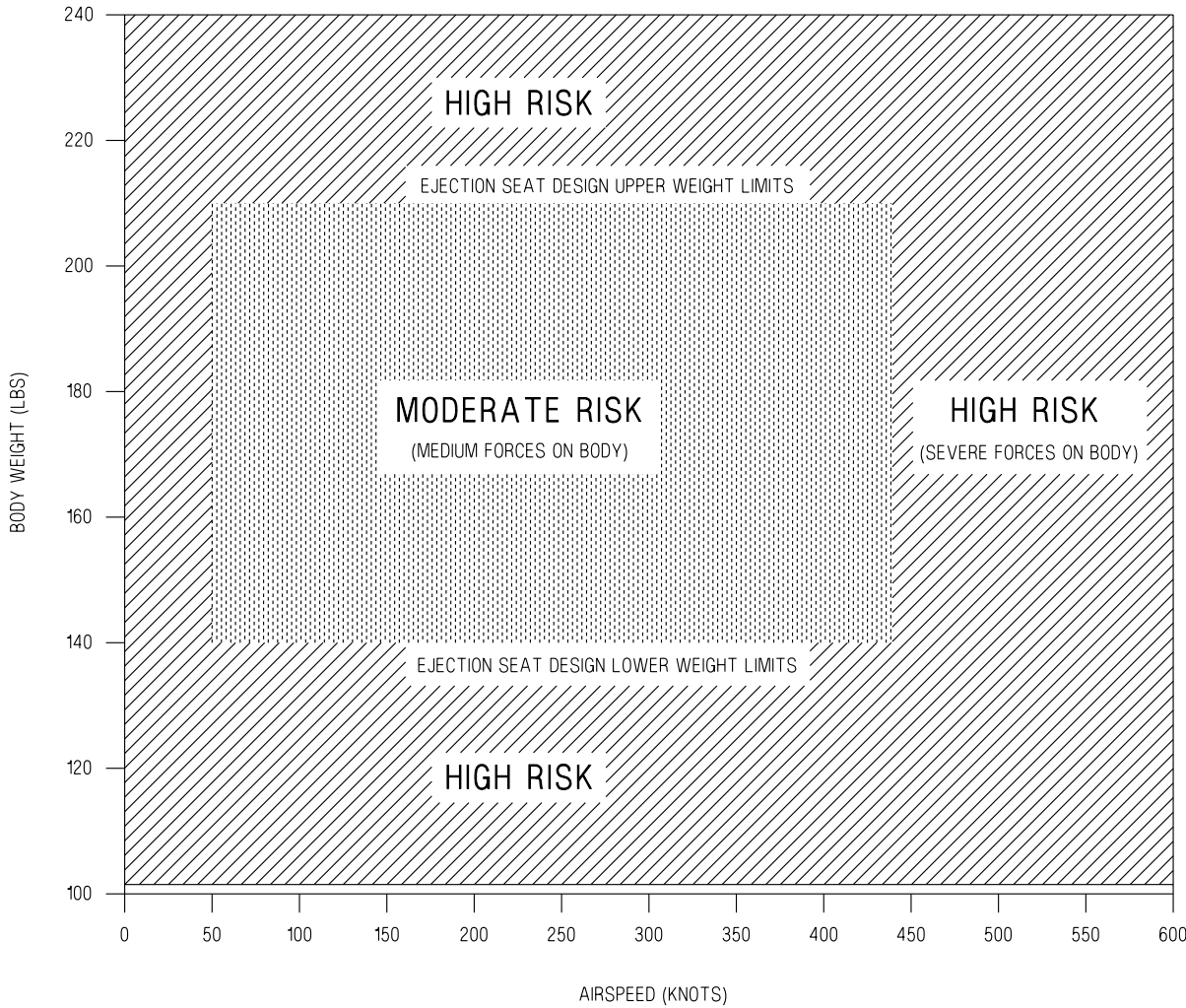

WARNING

PARACHUTE LANDING FALL INJURIES INCREASE SIGNIFICANTLY AS WEIGHT INCREASES.

NOTE

- EJECTION SEAT INJURY RISK DEFINITIONS
- MODERATE RISK: MAJOR/FATAL INJURY RATE IS APPROXIMATELY 27%
- HIGH RISK: MAJOR/FATAL INJURY RATE ESTIMATED TO BE ABOVE 80%

T38002-256-1-021

Figure 3-10. T-38 Ejection Injury Risk

T.O. 1T-38C-1

EJECTION PROCEDURE (AFTER T.O. 1T-38C-546)

The US16T-1 and US16T-2 ejection seats provide safe escape for most values of aircraft altitude, velocity and flight path using the procedures in Figure 3-11 at or between the following limits:

- a. Zero altitude at zero velocity in near level attitude.
- b. Limits of aircraft maximum velocity between zero and maximum altitude.

WARNING

If the aircraft is not controllable, ejection must be accomplished at whatever speed exists, as this offers the only opportunity for survival. At sea level, wind blasts and deceleration will exert medium forces on the body up to approximately 450 KCAS (0.7 Mach), severe forces causing flailing and skin injuries between 450 (0.7 Mach) and 600 KCAS (0.9 Mach) and excessive forces above 600 KCAS (0.9 Mach). As altitude increases, the speed ranges of the injury-producing forces will be a function of the Mach number.

In flight, the optimum speed for ejection is in the range of 200 to 300 KCAS. To avoid excessive loading on the parachute and the seat occupant, reduce the aircraft speed, whenever possible, to within the optimum range before ejecting.

Ejection envelope charts give recommended minimum terrain clearance in feet Above Ground Level (AGL) for range of aircraft dive angle, bank and sink rate values (Figure 3-13).

AIRCREW/SEAT SEPARATION

Usually below 15,000 feet, automatic parachute deployment and aircrew/seat separation sequence has occurred (Figure 3-12) unless the barometric controlled g switch has operated to delay parachute deployment until speed and g forces are reduced.

Manual Separation Procedure

WARNING

If below 12,000 feet AGL, and aircrew/seat separation has not occurred automatically, initiate the separation manually. Aircrew/seat separation at low altitude can cause injury or death.

Initiate manual aircrew/seat separation using the manual override handle in the following conditions:

1. Below 12,000 feet AGL
2. Aircrew/seat separation has not occurred automatically.

SSK Deployment

WARNING

If landing is to be made into water, it is important that the SSK is lowered before splash down.

NOTE

If landing in or through a tree canopy, do not deploy the SSK.

1. If necessary, deploy the SSK.

Parachute Steering

1. If necessary, change the direction of flight with the steering lines.

Preparation for Landing

1. Identify wind direction near ground by observing white caps on water, smoke from wreckage, or known winds in adjacent location.
2. When near ground or water, turn into wind.

Parachute Landing

1. On ground, disconnect the parachute canopy.
1. In water, when the Universal Water Activated System (UWARS) initiates and the canopy is released, get away from the parachute canopy.
2. Pull SSK, life raft, and personal locator beacon near with the lowering line.

Boarding the Life Raft

1. Board the life raft.
2. Pull the SSK with the lanyard.

TERRAIN CLEARANCE**WARNING**

- If the wings are not level, the effects of bank angle must be added to calculate the minimum altitude for ejection. An ejection below the minimum altitude for ejection can cause injury or death.
- Do not eject in the conditions below the curves on the terrain clearance charts. An ejection below the minimum altitude for ejection can cause injury or death.

Use the terrain clearance data and charts (Figure 3-13) to calculate the safe and dangerous conditions for ejection.

Calculate the minimum altitude for ejection in the relation with the dive angle as follows:

NOTE

The performance shown is for near sea level atmospheric conditions, with the wings of the aircraft level.

- a. See Figure 3-13, sheet 1.
- b. Add more altitude to the minimum altitude for ejection to give a safe ejection above high altitude terrain.
- c. Increase the minimum altitude for ejection by 1 % for each 1,000 feet of aircraft altitude above MSL.

Calculate the minimum altitude for ejection in relation to the sink rate as follows:

NOTE

The performance shown is for near sea level atmospheric conditions, 150 KCAS airspeed, wings level, and a small nose up attitude

- a. See Figure 3-13, sheet 2.

Calculate the minimum altitude for ejection in the relation to the bank angle as follows:

NOTE

The performance shown is for near sea level atmospheric conditions, with the wings of the aircraft level.

- a. See Figure 3-13, sheet 3.
- b. Add more altitude to the minimum altitude for ejection to provide safe ejection above high altitude terrain.
- c. Increase the minimum altitude for ejection by 1 % for each 1,000 feet of aircraft altitude above MSL.

Ejection - On Ground

Verify the following conditions are met:

- a. All straps are secured properly.
- b. SAFE/ARMED handle is set to ARMED.
- c. Canopy is closed and locked.
- d. The aircraft is level.

Ejection - Low Level

Make the decision to eject from an analysis of the minimum velocity, minimum altitudes and terrain clearance data. See Figure 3-13 and TERRAIN CLEARANCE, this section.

If the aircraft is in an uncontrollable nose down attitude, eject immediately.

If possible, increase the altitude. Increased altitude provides increased time to do the following operations and procedures:

1. Complete aircrew/seat separation.
2. Fully deploy the parachute.
3. Fully prepare for landing.

Execute the Before Ejection procedure and begin the ejection sequence.

Ejection - High Altitude

If possible, change the aircraft velocity, altitude, and attitude to get the recommended conditions for a safe ejection.

1. If possible, turn the aircraft away from inhabited areas.

T.O. 1T-38C-1

2. Execute the Before Ejection procedure and begin the ejection sequence.

BEFORE EJECTION

If time permits and conditions permit -

1. Notify crewmember of decision to eject.
2. Select IFF to EMERGENCY.
3. Distress call - TRANSMIT
If not in radio contact with appropriate agencies, tune radio(s) to GUARD and transmit MAYDAY.
4. If possible, adjust aircraft airspeed, altitude, and attitude to the following recommended safe ejection conditions:
 - a. 200 to 300 KCAS.
 - b. 2000 to 4000 feet AGL; 2000 feet AGL minimum
 - c. Straight and level flight.

WARNING

If the aircraft is not controllable, ejection must be accomplished regardless of aircraft parameters since immediate ejection offers the best opportunity for survival.

5. Loose equipment - STOW
6. Visor(s) - DOWN
7. Oxygen mask and helmet chin strap - FASTEN AND TIGHTEN, AS REQUIRED.
8. Leg garters - CHECK
9. Inertia reel lever - AFT (LOCKED)
10. Lap and shoulder straps - TIGHTEN
11. Turn aircraft toward uninhabited area.
12. Loose equipment - STOW
13. ADU mode selector knob - AUTO/MANUAL, AS REQUIRED
14. Assume proper body position - HEAD BACK, ELBOWS CLOSE INTO BODY, LEGS EXTENDED BUT NOT RIGID.

WARNING

Verify body posture is correct for the ejection. Incorrect body posture can cause injury or death.

Adjust body posture for ejection as follows:

- a. Ensure spine is straight.

- b. Press head tightly against the seat head pad.
- c. Extend legs forward until the weight of the thighs is on the seat cushion; legs extended but not rigid.

EJECTION

1. EJECTION HANDLE - PULL

Hold the handle until aircrew/seat separation occurs.

If ejection does not initiate -

2. Ejection handle safety pin - VERIFY REMOVED
3. SAFE/ARMED handle - VERIFY ARMED
4. Ejection handle - RETRY

WARNING

To avoid injury, grasp handle and pull sharply towards chest keeping elbows against the body.

NOTE

If ejecting at low airspeed, one or both sets of risers may remain velcroed together following seat separation. This may create a slight increase in descent rate and/or an uncommanded turn. Manually separate the risers, if time permits. The steering line toggles are located on the back side of each of the front risers. To counter any uncommanded turns, unstow the opposite steering line or use risers for controllability.

AFTER EJECTION

Apply the following procedures immediately after ejection:

1. Parachute canopy condition - CHECK
2. SSK - DEPLOY AS REQUIRED

(AFTER T.O. 1T-38C-546)

WARNING

- ASSUME PROPER POSITION
- SIT ERECT, SPINE STRAIGHT
- HEAD FIRMLY AGAINST HEADPAD
- EXTEND LEGS FORWARD OF SEAT UNTIL FULL WEIGHT OF THIGHS ON CUSHION

1 EJECTION HANDLE - PULL

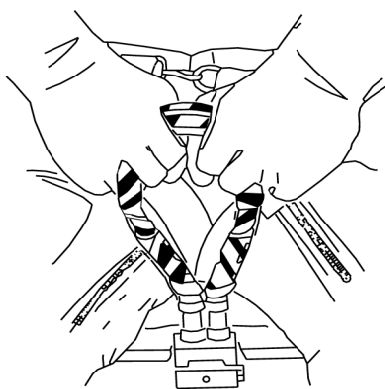

GRIP THE EJECTION HANDLE WITH THE THUMB AND AT LEAST TWO FINGERS OF EACH HAND, PALMS TOWARD BODY AND ELBOWS CLOSE TO BODY.



GRIP HANDLE WITH STRONG HAND PALMS INWARD, GRIP WRIST OF STRONG HAND WITH OTHER HAND, PALMS TOWARD BODY AND ELBOWS CLOSE TO BODY.

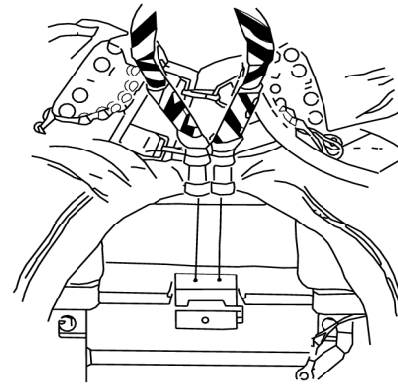

PULL HANDLE SHARPLY UP AND TOWARD ABDOMEN, KEEPING ELBOWS IN. INSURE TO PULL HANDLE TO END OF TRAVEL.

Figure 3-11. Ejection

T38002-350-1-020

(AFTER T.O. 1T-38C-546)

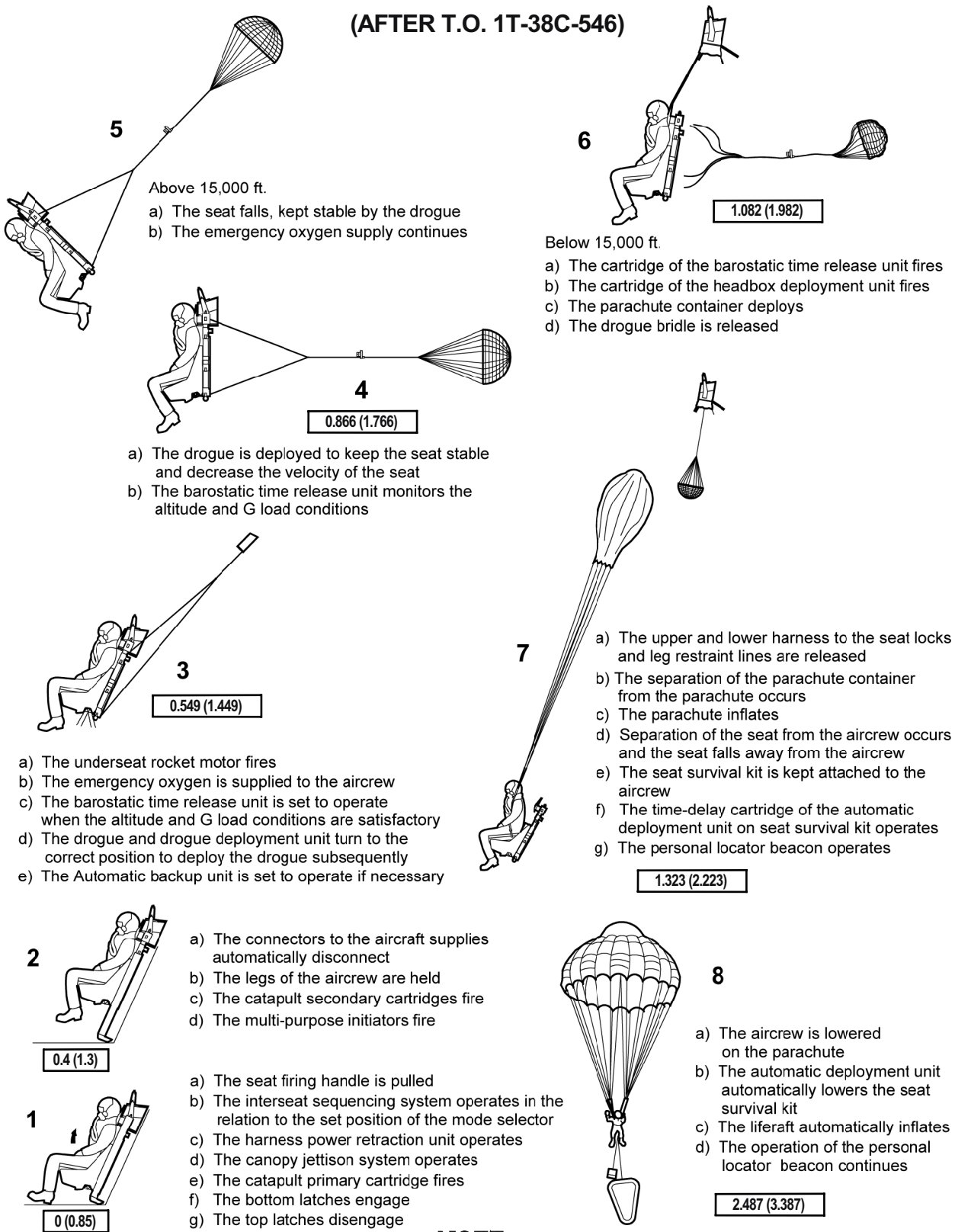

NOTE

- REAR SEAT (FRONT SEAT) EJECTION TIMING SEQUENCE.
- TIMES ARE WITH ISS IN BOTH, HEAVY AIRCREW MEMBER, ZERO ALTITUDE, 160 KEAS.

Figure 3-12. Ejection Sequence

T38002-349-1-020

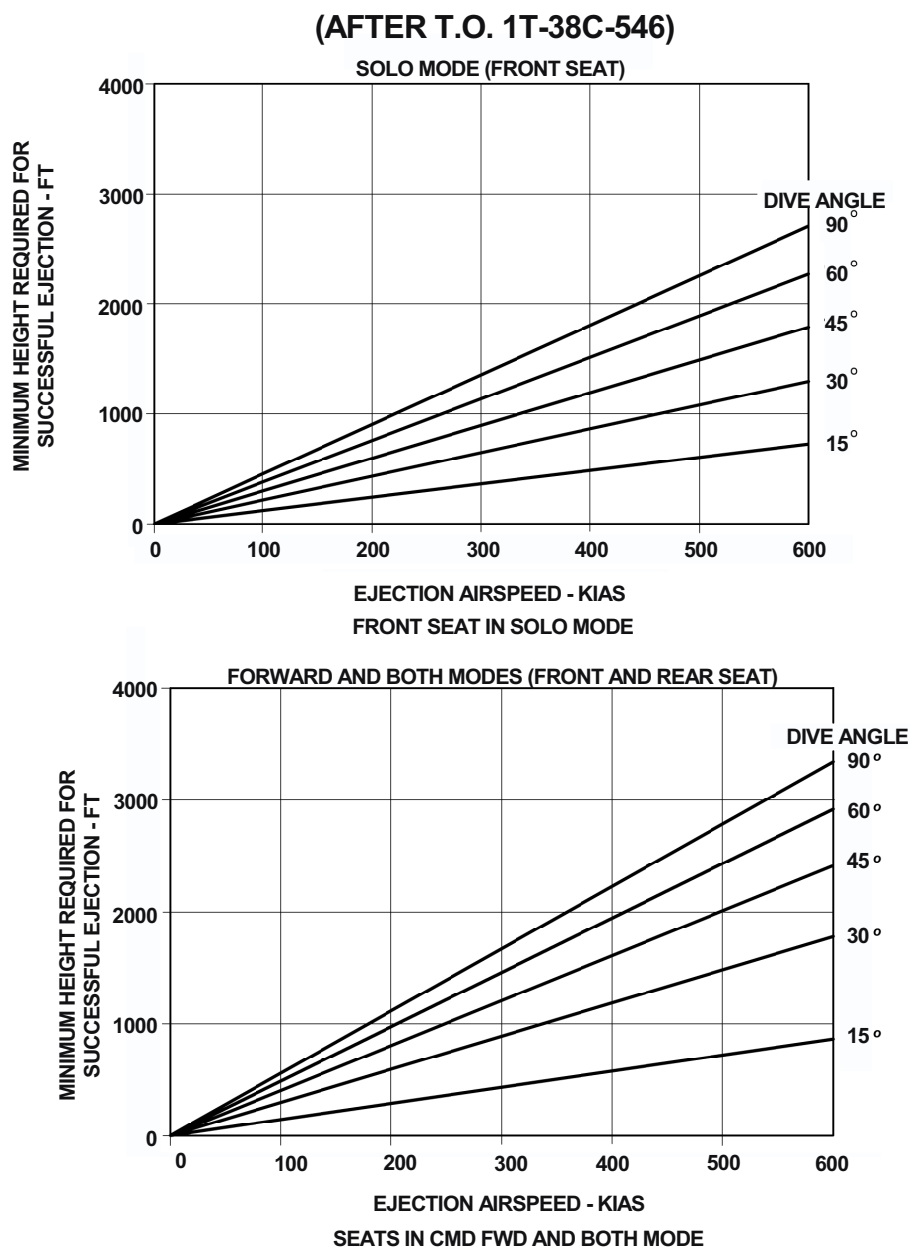

WARNING

- IF THE WINGS ARE NOT LEVEL, THE EFFECTS OF BANK ANGLE MUST BE ADDED TO CALCULATE THE MINIMUM HEIGHT FOR EJECTION.
- AN EJECTION BELOW THE MINIMUM HEIGHT FOR EJECTION CAN CAUSE INJURY OR DEATH.

NOTES

- MINIMUM ALTITUDES BASED ON INITIATION OF EJECTION SEAT(S).
- NO REACTION TIME IS INCLUDED.
- RECOMMENDED MINIMUM TERRAIN CLEARANCE IN FEET ABOVE GROUND LEVEL (AGL).
- ALL CLEARANCES ARE FOR EJECTION (SOLO/DUAL) AT MAXIMUM PILOT WEIGHT.
- INCREASE MINIMUM HEIGHT FOR EJECTION BY 1% FOR EACH 1,000 FEET OF AIRCRAFT ALTITUDE MSL.
- 3 KNOTS MUST BE ADDED TO CONVERT TO KCAS.

T38002-360-1-020

Figure 3-13. Minimum Ejection Altitude - Dive Angle (Sheet 1 of 3)

(AFTER T.O. 1T-38C-546)

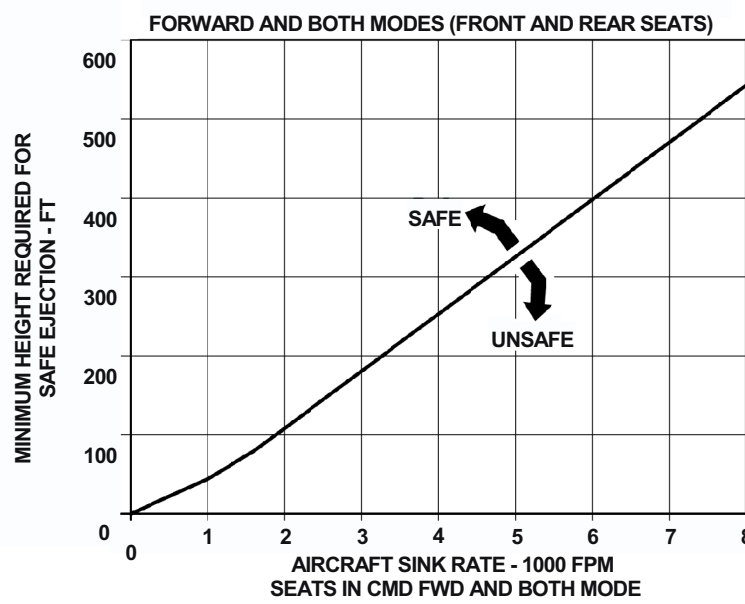
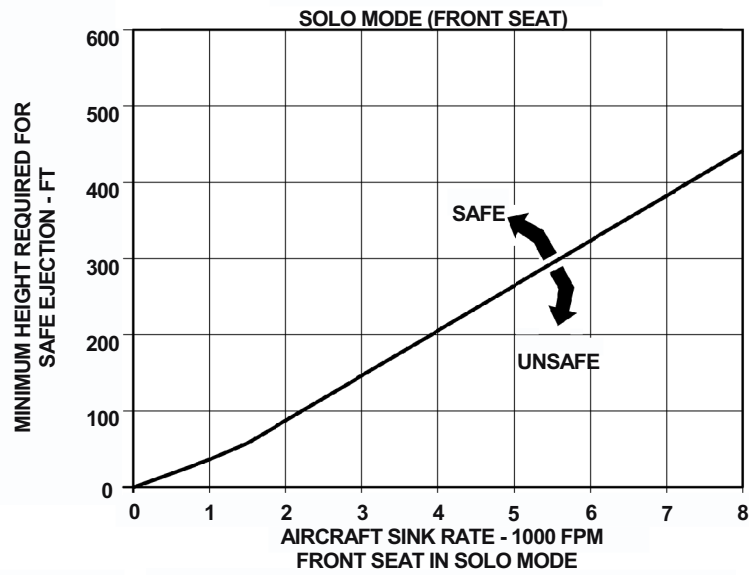

WARNING

- IF THE WINGS ARE NOT LEVEL, THE EFFECTS OF BANK ANGLE MUST BE ADDED TO CALCULATE THE MINIMUM HEIGHT FOR EJECTION.
- AN EJECTION BELOW THE MINIMUM HEIGHT FOR EJECTION CAN CAUSE INJURY OR DEATH.

NOTES

- MINIMUM ALTITUDES BASED ON INITIATION OF EJECTION SEAT(S).
- NO REACTION TIME IS INCLUDED.
- RECOMMENDED MINIMUM TERRAIN CLEARANCE IN FEET ABOVE GROUND LEVEL (AGL).
- ALL CLEARANCES ARE FOR EJECTION (SOLO/DUAL) AT MAXIMUM PILOT WEIGHT.
- PERFORMANCE SHOWN IS FOR NEAR SEA LEVEL ATMOSPHERIC CONDITIONS, 150 KIAS AIRSPEED, WINGS LEVEL, AND A SMALL NOSE-UP ATTITUDE.
- 3 KNOTS MUST BE ADDED TO CONVERT TO KCAS.

T38002-361-1-020

Figure 3-13. Minimum Ejection Altitude - Sink Rate (Sheet 2)

(AFTER T.O. 1T-38C-546)

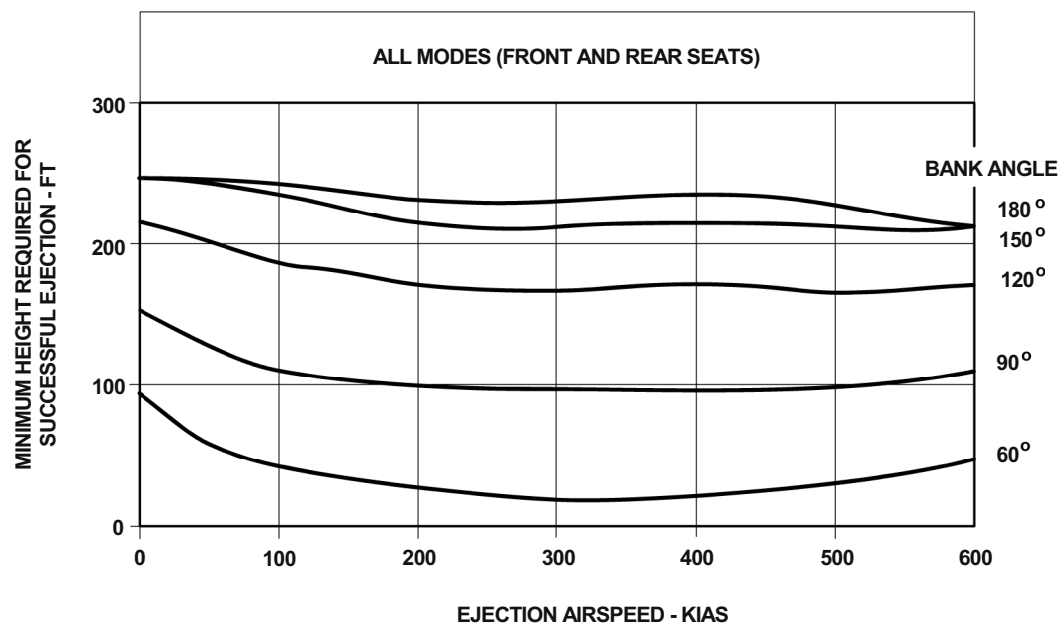

WARNING

- IF THE WINGS ARE NOT LEVEL, THE EFFECTS OF BANK ANGLE MUST BE ADDED TO CALCULATE THE MINIMUM HEIGHT FOR EJECTION.
- AN EJECTION BELOW THE MINIMUM HEIGHT FOR EJECTION CAN CAUSE INJURY OR DEATH.

NOTES

- MINIMUM ALTITUDES BASED ON INITIATION OF EJECTION SEAT(S).
- NO REACTION TIME IS INCLUDED.
- RECOMMENDED MINIMUM TERRAIN CLEARANCE IN FEET ABOVE GROUND LEVEL (AGL).
- ALL CLEARANCES ARE FOR EJECTION (SOLO/DUAL) AT MAXIMUM PILOT WEIGHT.
- INCREASE MINIMUM HEIGHT FOR EJECTION BY 1% FOR EACH 1,000 FEET OF AIRCRAFT ALTITUDE MSL.
- 3 KNOTS MUST BE ADDED TO CONVERT TO KCAS.

Figure 3-13. Minimum Ejection Altitude - Bank Angle (Sheet 3)

T38002-359-1-020

(AFTER T.O. 1T-38C-546)

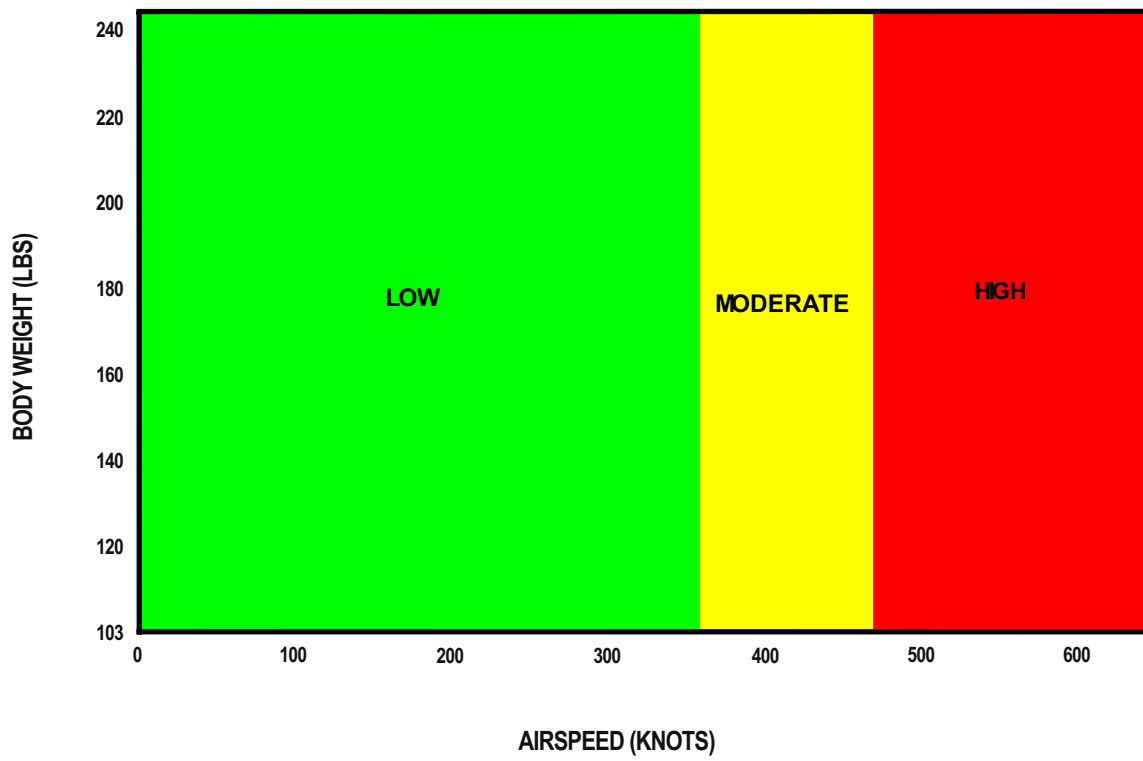

NOTES

- LOW (GREEN AREA): 9% MAJOR INJURIES (NO FATAL INJURIES PREDICTED).
- MODERATE (YELLOW AREA): 15 - 20% MAJOR INJURIES (NO FATAL INJURIES PREDICTED).
- HIGH (RED AREA): 100% MAJOR OR FATAL INJURIES.
- PREDICTIONS ARE BASED ON HISTORICAL DATA AND EJECTION SLED TESTS.
- ASSUMES MINIMUM ROLL, PITCH, AND/OR YAW AT EJECTION.
- INJURY PROBABILITY INCREASES WITH SPEED WITHIN EACH RISK AREA.
- PARACHUTE LANDING FALL (PLF) INJURIES INCREASE AS BODY WEIGHT INCREASES.
- OVERALL INJURY RISK IS LOWER THAN THAT OF THE ORIGINAL T-38 ESCAPE SYSTEM. THE UPGRADED ESCAPE SYSTEM INCORPORATES LEG RESTRAINTS WHICH REDUCE FLAILING INJURIES AT HIGHER SPEEDS. THE INTERSEAT SEQUENCING SYSTEM REDUCES THE PROBABILITY OF FRONT/REAR SEAT COLLISIONS AND ENTANGLEMENT.

Figure 3-14. Ejection Injury Risk

T38002-618-1-020

LOSS OF CANOPY

WARNING

- With a lost or damaged canopy, it is imperative the pilot confirms the speed brakes are retracted. The combination of canopy and speed brake drag may require afterburner to sustain level flight.
- After the canopy is lost or jettisoned, inadvertent drogue chute deployment is possible. Chute deployment could cause an immediate out-of-control condition.

1. Airspeed - SLOW TO BELOW 300 KCAS

NOTE

Minimum drag occurs at approximately 225 KCAS.

2. Reestablish intercockpit communications.
3. Land as soon as practical.

SMOKE, FUMES, OR ODORS IN COCKPIT (GROUND)

All odors not identifiable shall be considered toxic. If smoke, fumes or odors are encountered in the cockpit, proceed as follows:

1. Abort

If canopies are closed -

2. Oxygen - 100 %

NOTE

If odors persist, consider use of emergency oxygen bottle. If the emergency oxygen supply is activated, disconnect from the normal aircraft oxygen system.

3. Check for fire.
4. CABIN PRESS switch - RAM DUMP

5. Canopy - OPEN

NOTE

If aircraft is not stopped, ensure safe operating speed is attained prior to initiating canopy operation.

THROTTLE BINDING

If a binding or stuck throttle is experienced in flight, do not attempt further movement of the affected throttle. Attempt to minimize use of the unaffected throttle and recover using single engine procedures. Land as soon as possible.

If both throttles are stuck and altitude and airspeed permit, attempt to break one throttle free. Consider using zero or negative g to dislodge any foreign objects. If able, attain a power setting suitable for landing approach. If neither throttle can be freed, consider using the fuel shutoff switch to shutdown one engine. Aircraft weight, available runway length, and barrier capabilities should be taken into consideration if landing will be attempted with one or both throttles stuck at high power settings.

1. Stuck/binding throttle - DO NOT MOVE

CAUTION

Due to the close proximity of the throttle linkages and potential for foreign object interference, attempts to dislodge a stuck throttle may cause inadvertent shutdown of either engine.

2. Unaffected throttle - MINIMIZE MOVEMENT

If both throttles are stuck and altitude and airspeed permit, attempt to break one throttle free.

3. Land as soon as possible.

T.O. 1T-38C-1

**PITOT STATIC SYSTEM
MALFUNCTION**

1. PITOT HEAT switch - CHECK ON

NOTE

If pitot heat failure is suspected, check front cockpit center pedestal circuit breaker panel for a popped PITOT HEATER circuit breaker.

2. Cockpit instruments - COMPARE
(BOTH COCKPITS, INCLUDE STANDBY INSTRUMENTS)
3. Radar altimeter - USE BELOW 5000 FEET
AGL
4. Remain VMC, if possible.

3-72

LANDING EMERGENCIES

LANDING GEAR EXTENSION FAILURE

Unsafe cockpit gear indications should not be the only factor in the determination of an unsafe gear condition. Gear position should be determined by chase aircraft, if available, or other visual means. In the absence of visual confirmation of gear position, any gear that indicates down in one or both cockpits is down and locked based upon the independent warning systems for each cockpit green light indicator. If all gear are fully down (verified by chase or other visual means) but one or more are indicating unsafe, stop straight ahead on the runway and have the gear safety pins installed.

NOTE

An unsafe nose gear indication in the RCP prevents the HUD from transitioning to gear down symbology when the landing gear is lowered.

Before attempting a landing with gear up, carefully consider whether to attempt a landing or to eject. Use the following table as a guide in determining whether a landing is feasible. Disregard gear door position.

GEAR CONDITION*		RECOMMENDED ACTION
NOSE	MAIN	
UP	BOTH DOWN	LAND
UP	BOTH UP	LAND
UP	ONE DOWN	EJECT
DOWN	BOTH UP	
DOWN	ONE DOWN	

*Actual landing gear position (not indication)

WARNING

- Landing in lieu of ejection for gear conditions recommending ejection is considered more hazardous.
- Do not attempt to land on a main landing gear that is missing its wheel assembly.

NOTE

Landing with gear up may be accomplished with an empty/soft or non-flammable loaded WSSP installed.

The landing surface should be smooth and hard, i.e., no lips or joints between asphalt and concrete that could snag the WSSP. Approach end arrestment cables should be removed. The aircraft should be configured with speed brakes down and full flaps.

Use normal approach speeds for all configurations. Use normal touchdown speeds for all configurations except when landing all gear up. Minimize rate-of-sink at touchdown but maintain a normal landing attitude to avoid excessive slam-down. The procedures to be used for landing with gear extension failure are contained in the following paragraphs.

LANDING GEAR ALTERNATE EXTENSION

Landing gear alternate extension takes approximately 15-35 seconds.

If the landing gear fails to extend normally, leave the landing gear lever at LG DOWN and proceed as follows -

1. Airspeed - 240 KCAS OR LESS
2. FLAPS - AS REQUIRED
3. Gear door switch - OPEN
4. Landing gear lever - LG DOWN
5. Landing gear alternate release handle - PULL APPROXIMATELY 10 INCHES AND HOLD UNTIL GEAR UNLOCKS; THEN STOW HANDLE

T.O. 1T-38C-1

6. Gear position - CHECK



Stop straight ahead on the runway and have the landing gear safety pins installed prior to clearing runway.

NOTE

Once the three landing gear position indicators indicate that all three gear are down and locked, do not further activate landing gear controls.

After lowering the landing gear with the alternate release handle, do not attempt to reset the switches by cycling the landing gear lever. Cycling the landing gear lever may lead to further complications, particularly if the alternate release handle is not fully stowed.

If the main gear fails to extend fully, yawing the aircraft and applying negative or positive g forces may aid in extension.

If the landing gear has been extended by use of the landing gear alternate release handle, nosewheel steering will not be available for taxiing.

If the landing gear still fails to extend and utility hydraulic pressure is available, return hydraulic pressure to the landing gear system -

7. Landing gear lever - LG UP (MOMENTARILY), THEN DOWN

NOTE

The decision to land with the nose gear up or unsafe, all gear up, eject or continue with attempts to extend the landing gear should be carefully considered based on fuel remaining and the risk.

8. Landing gear alternate extension - REPEAT



If the main landing gear fails to extend to the locked position due to the main landing gear side brace pin backing out (verified by chase aircraft), repeated gear extension attempts may cause the pin to fall out of the side brace bellcrank. This can cause the gear to fail to retract or extend fully, resulting in a configuration prohibiting landing the aircraft.

9. Landing gear - RECYCLE

NOTE

Repeated attempts of steps 8 and 9 have resulted in successful gear extensions. Repeated alternate landing gear extension attempts while yawing the aircraft and applying negative or positive g forces may aid in extension.

If unsafe gear indication remains -

10. Generators - OFF
11. BATTERY switch - OFF
12. Landing gear alternate release handle - PULL 10 INCHES AND HOLD UNTIL GEAR UNLOCKS; THEN STOW HANDLE
13. BATTERY switch - ON
14. Generators - ON
15. Gear position - CHECK

NOTE

Any combination of three green landing gear lights between the front and rear cockpits is a safe gear indication. Press to test any unlit bulbs. Burned out bulbs can be replaced with the trim light, boost pump lights (RCP), or from the spare bulb kit.

If all gear remain up and locked after using both normal and emergency lowering procedures, accomplish steps 16 thru 24. This procedure is only effective if all the landing gear have remained up and locked after using both normal and emergency lowering procedures.

If all gear have remained up and locked throughout all of the normal and emergency lowering attempts, proceed as follows -

16. Gear door switch - CHECK OPEN
17. Throttle gate - DISENGAGE
18. Throttle (left engine) - OFF
19. Control stick - RAPID LATERAL STICK MOVEMENTS TO DEplete UTILITY HYDRAULIC PRESSURE
20. Landing gear lever - LG DN
21. Landing gear alternate release handle - PULL APPROXIMATELY 10 INCHES WHILE PRESSURE IS DEPLETED AND HOLD UNTIL GEAR UNLOCKS; THEN STOW HANDLE
22. Gear position - CHECK (IF INDICATIONS ARE STILL UNSAFE, LANDING LEVER LG UP, THEN LG DN)
23. Left engine - RESTART
24. Throttle gate - ENGAGE

If fuel is critical and unsafe condition remains, refer to one of the following procedures:

- a. ENGINE FAILURE/SHUTDOWN DURING FLIGHT
- b. RESTART DURING FLIGHT
- c. LANDING WITH ALL GEAR UP
- d. LANDING WITH NOSE GEAR UP/UNSAFE
- e. BEFORE EJECTION

LANDING WITH ALL GEAR UP

This procedure should be used only under favorable runway conditions. If possible, burn down fuel prior to landing.

1. Gear - UP

NOTE

With damage to the landing gear, the gear doors may not close, but they will either wear down, collapse, or break off upon gear-up landing.

2. CABIN PRESS switch - RAM DUMP
3. Shoulder harness - LOCK

4. Speed brake - OPEN

NOTE

After landing, the speed brake may grind down beyond the actuator attach point. When this occurs, expect the nose to drop suddenly accompanied by increased noise, vibration, and deceleration.

5. FLAPS - FULL DOWN (FLY A POWER-ON APPROACH REQUIRING MINIMUM FLARE)
6. Throttle gate - DISENGAGE
7. Landing pattern - NORMAL (PLAN TO TOUCHDOWN 10 KNOTS ABOVE NORMAL TOUCHDOWN SPEED)



Consider using the auxiliary flap control switch to reposition the flaps. If damage to the flaps or flap actuating mechanism is known or suspected, do not reposition flaps.

8. Throttles - OFF AT TOUCHDOWN
9. BATTERY switch - OFF

LANDING WITH NOSE GEAR UP/ UNSAFE

1. CABIN PRESS switch - RAM DUMP
2. Shoulder harness - LOCK
3. FLAPS - FULL DOWN
4. Throttle gate - DISENGAGE
5. Landing pattern - NORMAL
6. Throttles - IDLE AT TOUCHDOWN
7. Nose - GENTLY LOWER TO RUNWAY
Leave the left engine running until gear is pinned. Utility hydraulic pressure may keep the gear from collapsing.

If nose gear is up -

8. Throttles - OFF, WHEN NOSE TOUCHES RUNWAY

T.O. 1T-38C-1

9. Wheel brakes - AS REQUIRED



When the nose gear is down but indicates unsafe, do not use brakes if a safe stop can be made without them.

10. BATTERY switch - OFF

NO FLAP LANDING

If landing is to be made with the flaps retracted, use the normal landing procedure modified as follows:

As a guide, the no flap landing distance is approximately 2X (2500 + fuel weight) past the touchdown point. Consider burning down fuel to reduce landing roll.

1. Downwind leg - EXTEND
2. Airspeed - INCREASE THE FINAL TURN, FINAL APPROACH AND TOUCHDOWN SPEEDS BY 15 KCAS



Cautious braking must be exercised when applying wheel brakes between 100-130 KCAS as locked wheels or tire skids are difficult to recognize. If a tire skid is detected, immediately release brakes and cautiously reapply.

NOTE

A no flap full stop landing using aerobraking to just prior to loss of elevator authority and optimum braking thereafter may double the normal landing distance.

SINGLE-ENGINE APPROACHES

A maximum of 300 KCAS shall be maintained for single-engine non-precision, radar, or ILS approaches during approach maneuvering prior to extending the gear. See Figures 3-15, 3-16, and 3-17. Delay lowering landing gear until just prior to glide slope if heavy fuel loads, engine anti-ice operation, turbulence, or other

conditions cause single-engine MIL thrust to be inadequate for gear down level flight at recommended airspeeds. MAX thrust should be used on single-engine approaches, if necessary.

SINGLE-ENGINE MISSED APPROACH

See Figures 3-15, 3-16, and 3-17 for single-engine approach power settings and configurations. If a single-engine missed approach is necessary, use the procedure for SINGLE-ENGINE GO-AROUND.

SINGLE-ENGINE GO-AROUND

The available altitude and/or runway should be used to accelerate. The aircraft should be rotated at final approach speed or as required to become airborne prior to the end of the runway, whichever comes first. Allow the aircraft to accelerate straight ahead, climbing only as necessary, until reaching 200 KCAS.

If, during the go-around, a touchdown occurs and take-off appears questionable, an abort may be warranted.

1. THROTTLE(S) - MAX



A single-engine go-around should be attempted only at MAX power.

2. FLAPS - 60%



With other than 60% flaps, single engine capability is impaired to such an extent that the combination of temperature, pressure altitude and gross weight may make go-around impossible.

NOTE

- If unable to retract the landing gear, best level flight/climb capability is obtained at 200 KCAS with 60% flaps or at 220 KCAS with the flaps up. At high gross weights, with the landing gear

extended, flap retraction should not be initiated prior to 220 KCAS.

- After flaps are set at 60% the flap indicator should be checked to ensure flaps are within the 60% range (55–65%).

3. AIRSPEED - ATTAIN FINAL APPROACH SPEED MINIMUM

WARNING

- It may be necessary to lower the nose to sacrifice altitude and perhaps allow the aircraft to settle to the runway to attain final approach speed. If the aircraft settles to the runway, lower the nose to facilitate acceleration.
- Attaining final approach airspeed will ensure excess thrust for single-engine flight.

4. GEAR - UP (AS REQUIRED ABOVE FINAL APPROACH SPEED)

NOTE

If the left engine is inoperative but windmilling, generally gear retraction may be accomplished, but will require an extended time period; however, gear doors may not completely close. Gear retraction when initiated between final approach speed and 200 KCAS, may require up to 1 minute.

5. FLAPS - UP (AS REQUIRED ABOVE 200 KCAS)

SINGLE-ENGINE LANDING

A straight-in approach should be flown. See Figure 3-18 for single-engine approaches.

The following considerations apply:

- Under certain conditions, level, configured, single-engine flight may be impossible. Consider delaying configuration until just prior to the glide-lope.
- Operating with one engine may cause yaw, especially in MAX. This can usually be controlled with the use of rudder.

- If the left engine has failed, have the landing gear pinned prior to taxiing clear of the runway (conditions permitting).

The following procedure should be accomplished before landing.

- Landing gear - CHECK DOWN

NOTE

- Power required under single-engine conditions may be in excess of that required to activate the landing gear warning system.
- If the left engine is inoperative, normal windmilling RPM will provide adequate utility hydraulic pressure for a landing gear normal extension in a slightly longer extension time. If utility hydraulic system pressure is depleted, use the landing gear alternate extension system to extend the gear and allow additional time for gear extension.

- FLAPS - 60%
(SET ON FINAL PRIOR TO DESCENT)
- FLAPS - DN WHEN LANDING IS ASSURED (OPTIONAL)

WARNING

Use maximum power, if necessary, to maintain landing pattern airspeeds. See Figure 6-2 section VI, for the effect of bank angle on vertical velocity.

CAUTION

- At high density altitudes and/or high gross weights, limited excess thrust is available to offset full flap drag. If full flaps are selected in the flare, an immediate touchdown and premature landing may occur.
- Aerodynamic braking with less than full flaps is less effective and longer landing distances should be anticipated (as much as 500 feet). If landing distance is computed to be greater than 2/3 of runway length, consider selecting full flaps once below full flaps landing air-speed.

SINGLE-ENGINE

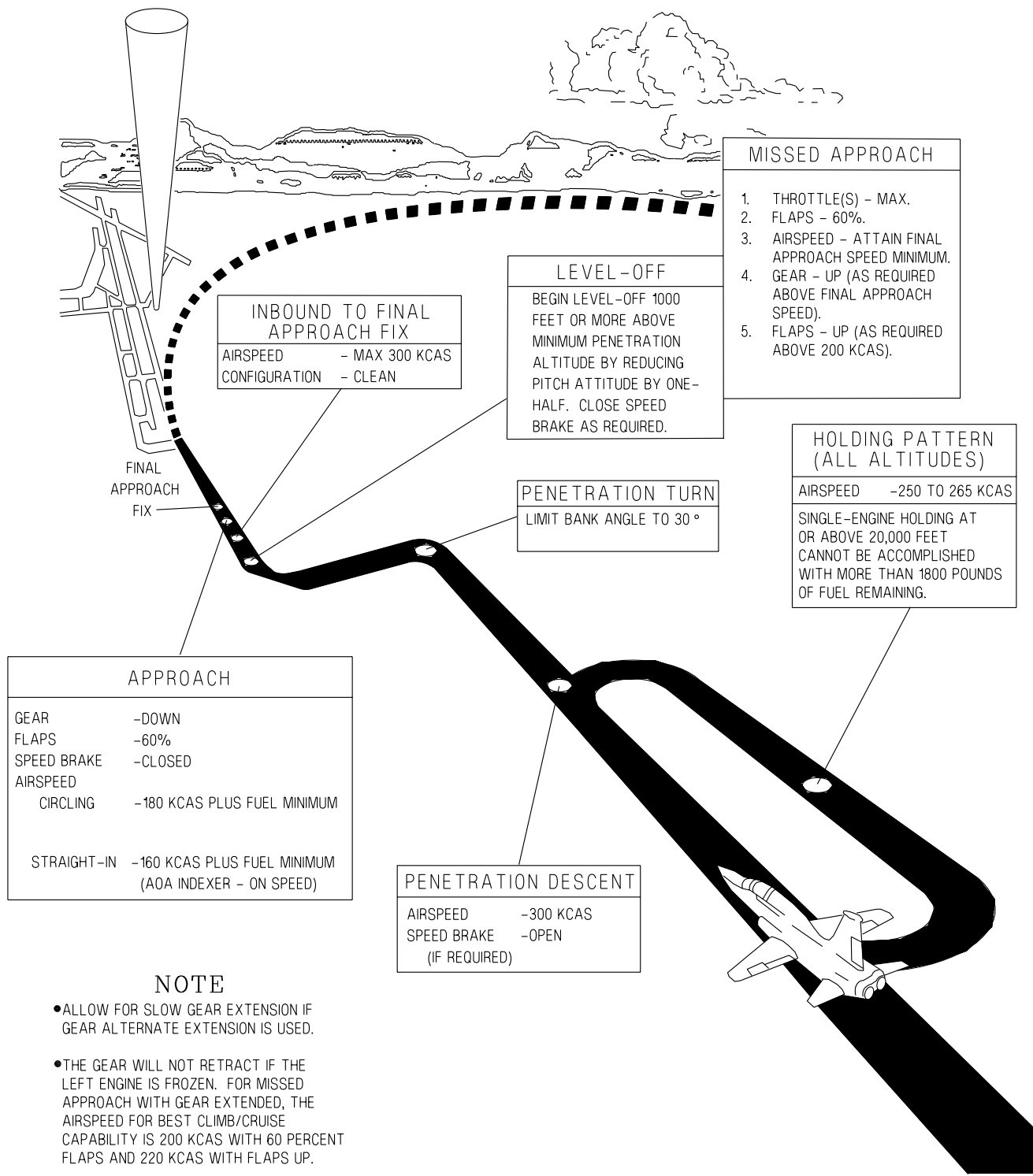

T38002-190-1-021

Figure 3-15. Holding, Penetration, and Approach (Typical)

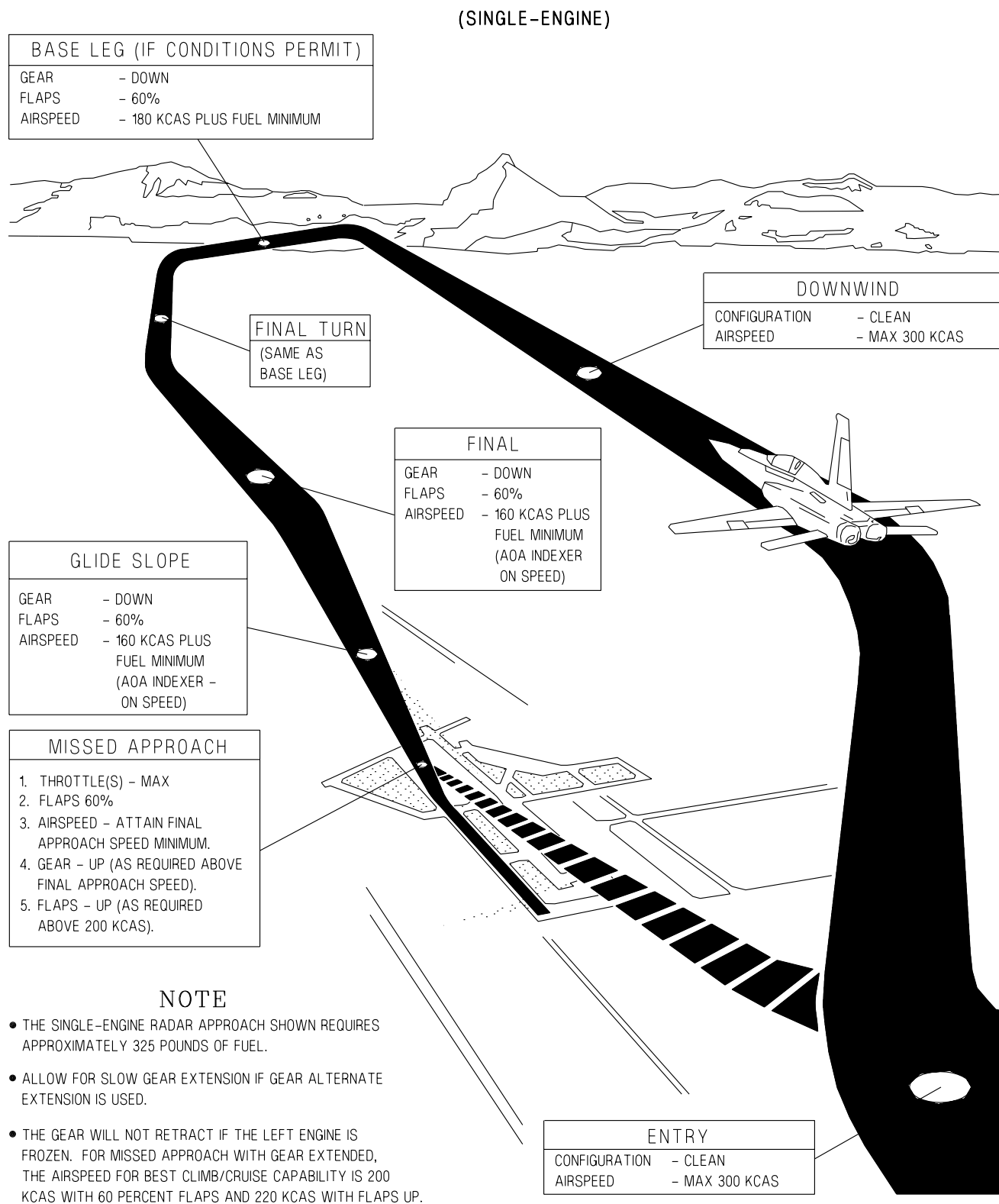

T38002-192-1-021

Figure 3-16. Radar Approach (Typical)

SINGLE-ENGINE

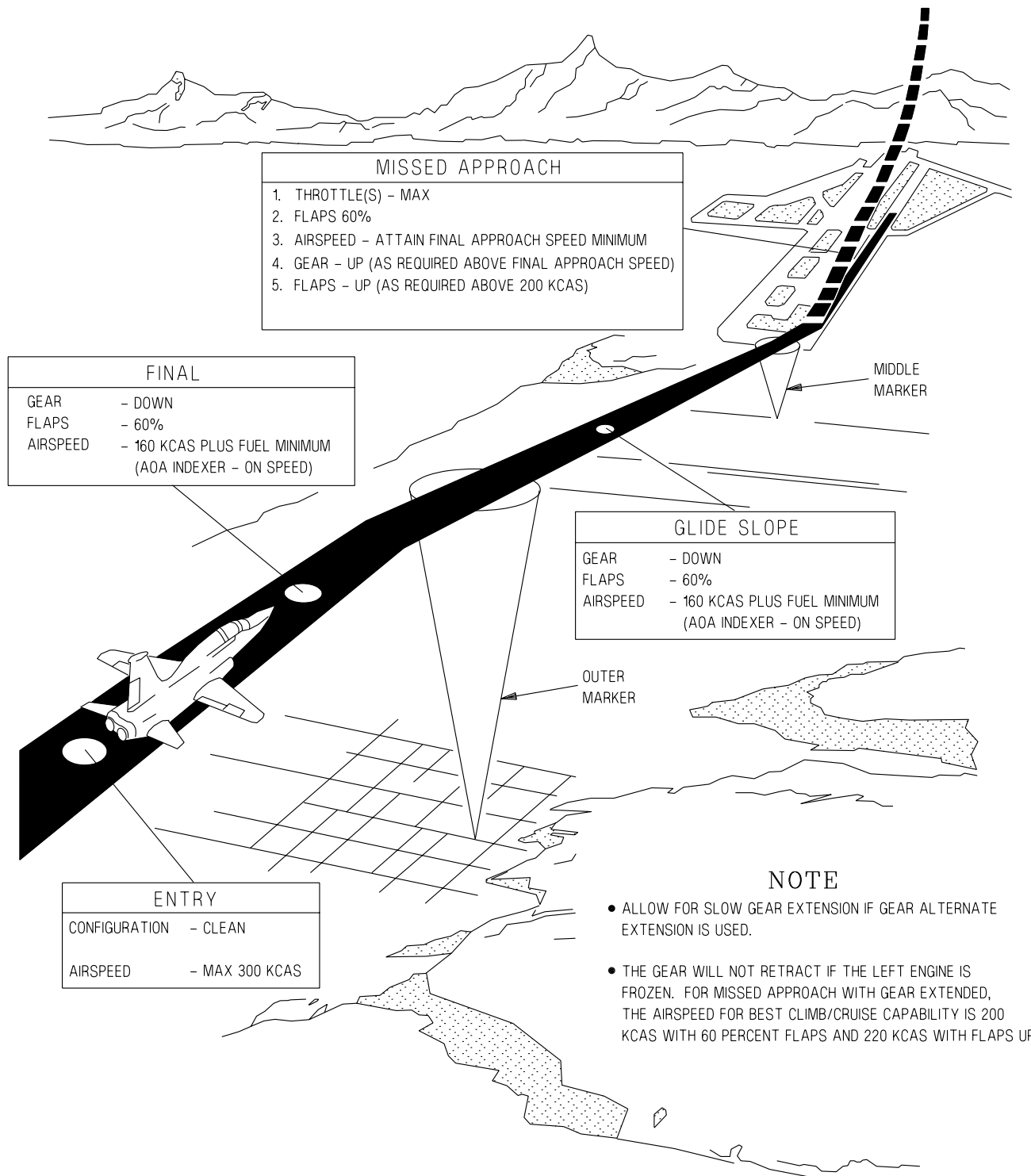

T38002-194-1-021

Figure 3-17. ILS Approach (Typical)

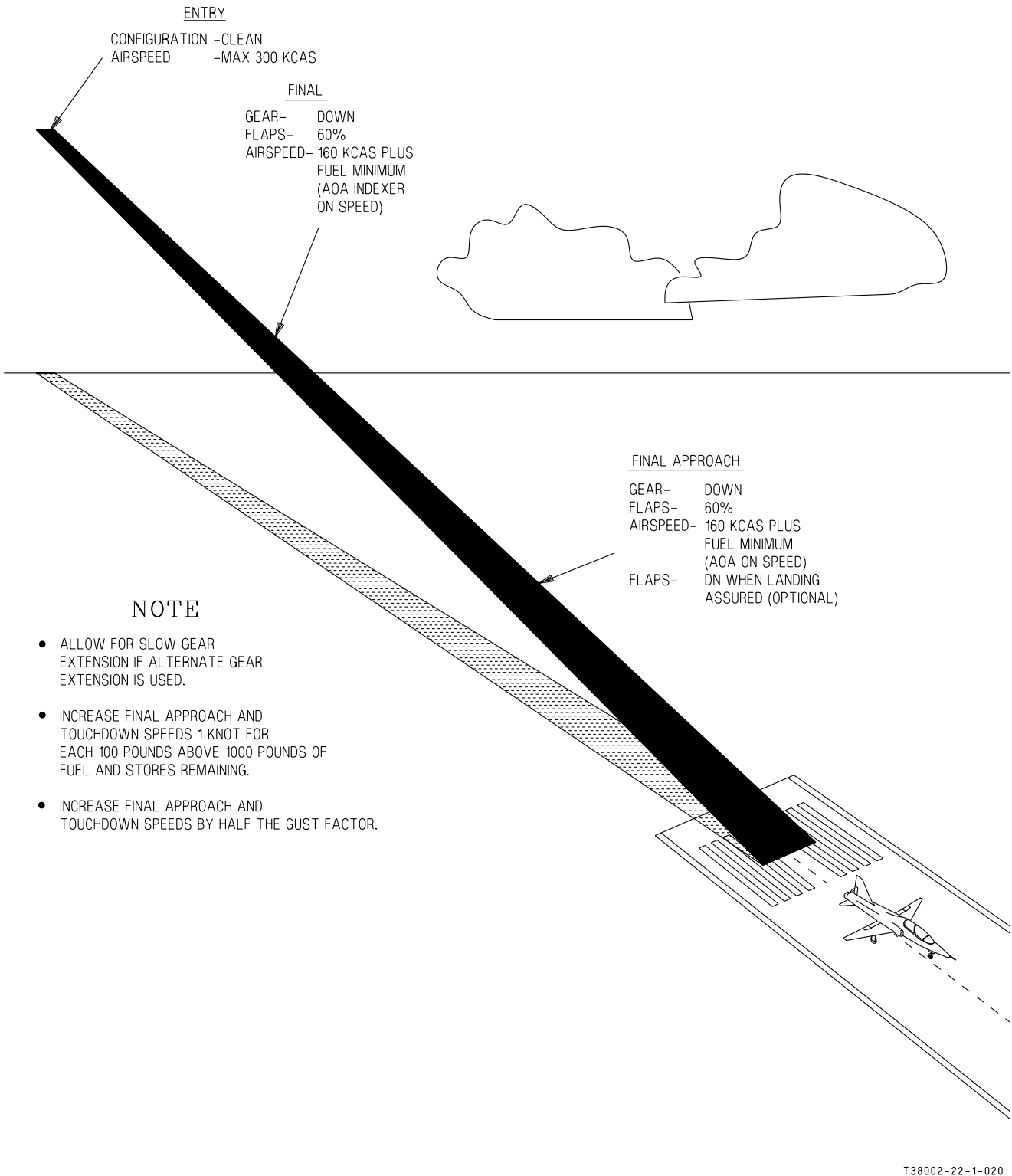

Figure 3-18. Single-Engine Landing Pattern (Typical)

T.O. 1T-38C-1

**LANDING WITH BLOWN TIRE,
LOCKED BRAKE OR DIRECTIONAL
CONTROL DIFFICULTY**

The aircraft may be safely landed with a blown tire, locked brake, or similar directional control difficulty. Plan to land at minimum gross weight unless landing sooner is necessitated. Go-around after touchdown on a blown tire or locked brake should be avoided as rubber or other debris may be ingested by the engines. When it has been determined that a main gear tire has blown or a brake is locked, land on the side of the runway away from the malfunction. Make maximum use of rudder and wheel braking to maintain directional control. Nosewheel steering should be engaged only as a final attempt to maintain or regain directional control.

WARNING

If one brake fails or failure is suspected, with no other directional control problems such as a blown tire or locked brake, plan to land in the center of the runway. Stop the aircraft by using aerodynamic braking followed by a combination of wheel brake and nosewheel steering. Rudder pedals should be neutralized prior to engaging the nosewheel steering to prevent violent swerving and possible loss of directional control.

Once the aircraft is stopped, do not clear the runway or change configuration or activate flight controls. Shut down engines when maintenance/fire equipment are in position.

3-82

AVIONICS MALFUNCTIONS

EED INTERNAL FAILURE

If the EED detects an internal failure that prevents the EED from displaying reliable engine data, FAIL is displayed in place of the digital readout for that gauge and EED FAIL is displayed in the center of the EED. The pointer is also removed on the failed gauge.

NOTE

- For engine and fuel data to display, at least one EED must be on and operating.
- In slave mode, the failed EED continues to display EED FAIL in the center of the display; however, FAIL is removed from all previously failed gauges. Accurate gauge data is provided by the Master EED.

If EED modes do not switch -

1. M pushbutton - PRESS

If EED still failed -

2. EED O/N/D Power Knob - CYCLE OFF THEN DAY OR NIGHT (AS APPROPRIATE)
After switching, wait 15 seconds for displays to re-initialize.

NOTE

If EED still failed, EED data may be viewed on the MFD MENU Display Page (EED Display Page).

If EED still failed -

3. Land as soon as practical.

EED SENSOR FAILURE

If the EED detects no signal from an external sensor (except RPM or EGT), OFF is displayed for that gauge. The RPM and EGT display zero with no sensor signal.

If EED is in Slave -

1. M pushbutton - PRESS

If OFF condition persists -

2. Cycle power on FCP and RCP EEDs.

If OFF condition continues -

3. Land as soon as possible.

EED INTERNAL BIT FAILURE

When the EED detects an internal failure that does not affect an ability to display engine data, BIT FAIL is displayed in the center of the EED.

If failed EED is Master -

1. M pushbutton - PRESS

NOTE

In SLAVE MODE, the failed EED continues to display BIT FAIL in the center of the display. All engine data is provided by the Master EED.

EED HOT

NOTE

- If EED HOT is displayed in the EED message window, display brightness is reduced by 50% in Day mode.
- If hot condition continues to exist 1 minute after EED HOT comes on, the EED lamps shut off.

1. If required, monitor engine instruments via the EED in the other cockpit or via the EED repeater on the MFD.
2. Land as soon as conditions permit.

EGI FAILURE - GPS

Refer to UFCP EGI function page -

1. Confirm EGI source for navigation - EGI

T.O. 1T-38C-1

The EGI mode does not change. The blended EGI solution is based solely on INS. INS attitude information is not affected by the loss of GPS and navigation information is only slightly degraded (drift rate of up to 0.8 NM per hour).

CAUTION

If a GPS failure occurs, do not cycle the EGI power to regain GPS operation. INS is still available provided EGI power is not cycled. Cycling the EGI Power Switch while in flight will force an Air-Align which cannot be accomplished without GPS, forcing the EGI into ATT mode. The EGI supplies only attitude and relative heading data in ATT mode and g is not available.

EGI FAILURE - INS

When only the INS fails, the MDP removes attitude from the HUD and MFD displays. An empty circle replaces the EADI on the MFD. Flight by reference to standby instruments is required. Heading information on the MFD (PFR, HSD, and MFD MENU page) is unreliable. Heading information displayed on the HUD represents GPS-derived ground track. The EGI bearing pointer still displays an accurate course to the steerpoint, but it is not relative to the display. Also, VOR magnetic bearing and distance, ILS localizer, glideslope raw data, TACAN bearing and distance, altitude, airspeed and angle of attack continue to be displayed. Ground based navigation by reference to the standby compass and radial/bearing information from the MFD or NAV backup control panel should be initiated. Following a successful in flight alignment, probability of a repeat failure is increased.

1. Refer to standby instruments for attitude and heading.
2. Maintain unaccelerated level flight.
3. AAP EGI power switch - OFF (10 SECONDS MINIMUM) THEN ON (IN FLIGHT ALIGNMENT BEGINS)

WARNING

When only the INS fails, valid GPS ground track is available in the HUD. By cycling EGI power, it is possible for GPS data to be lost. Pilots should use judgement and consider all factors (i.e. weather, instrument approach options, etc.) before cycling EGI power.

4. LEVEL is displayed in the HUD during EGI ATT mode and into Air-Align mode.
5. Confirm MFD EGI page transitions into ATT mode and Air-Align mode, if not, the in flight alignment has failed.

WARNING

Erroneous attitude indications can be displayed during the EGI IFA process. Consideration should be given to availability of a visible horizon prior to initiating an IFA. If an alignment is required with no visible horizon, refer to standby instruments for attitude and heading information until the alignment is complete.

If In flight alignment fails -

6. Land as soon as practical.

See Figure 3-19 for MFD and HUD displays affected by EGI FAILURE - INS failures.

EGI FAILURE - TOTAL

When the EGI fails, the MDP removes attitude information from the HUD and MFD displays. An empty circle replaces the EADI. 360 will be displayed on the heading scale on the MFD and be blank in the HUD. Flight by reference to standby instruments is required. VOR magnetic bearing and distance, ILS localizer, glideslope raw data, TACAN bearing and distance, altitude, airspeed and angle of attack continue to be displayed. Ground based navigation by reference to the standby compass and radial/bearing information from the MFD or NAV backup control panel should be initiated. Following a successful in flight alignment, probability of a repeat failure is increased. See EGI FAILURE - INS, this section.

MFD SYMBOLOGY	
Calibrated Air Speed	Remains displayed
Flight Director Pitch Steering Bar	Removed
Vertical Deviation Indicator	Remains displayed unless SCA is PNS
Flight Director Bank Steering Bar	Removed
AOA Indicator	Remains displayed
EGI range	GPS based if INS fails, removed if subsystem fails
EGI Bearing Pointer	GPS ground track based if INS fails, removed if subsystem fails
To/From Pointer	GPS ground track based if INS fails, removed if subsystem fails and EGI is PNS
Time - CRN and TOD	Remains displayed
Digital display of ground speed	GPS based if INS fails, GS digits removed if subsystem fails
Radar Altitude	Remains displayed
Altitude Indicator	Remains displayed, but the IVV arc is removed
QNH	Remains displayed
G-meter	Remains displayed, but the needle, G-limit tic marks and current G-digital reading are removed
Bank and side slip	Removed
Wind direction and velocity	Removed
Heading set marker	Remains displayed
Course select window	Remains displayed
VOR bearing pointer	Remains displayed
TACAN bearing pointer and range	Remains displayed
TCAS targets	Displayed if INS fails, removed if subsystem fails
Course Deviation Indicator	Remains displayed - GPS ground track based if INS fails, removed if subsystem fails and EGI is PNS
NAV/COMM data block	Remains displayed
Time to go	Digits are removed, only the TTG remains
TCAS mode	Remains displayed
Instantaneous Vertical Velocity	Removed, only the title VV remains
HSD and HSI	Heading indications are unreliable if INS fails, heading changes to 360 if subsystem fails
Heading on menu pages	Heading indications are unreliable if INS fails, digits removed if subsystem fails

Figure 3-19. MFD AND HUD DISPLAYS AFTER EGI FAILURE - INS OR SUBSYSTEM FAILURE (Sheet 1 of 2)

T.O. 1T-38C-1

HUD SYMBOLOGY	
Course deviation indicator (CDI)	Remains displayed - GPS ground track based if INS fails, removed if subsystem fails and EGI is PNS
Flight path marker	Removed
Climb/dive marker	Removed
Waterline/boresight cross	Remains displayed
Pitch ladder and horizon line	Removed
Target designator box	Removed
Time of day	Remains displayed
Digital fuel block	Remains displayed
Barometric altitude scale/dial and indicator	Remains displayed
Radar altimeter readout	Remains displayed
Altitude warning (F-16 HUD only)	Remains displayed
EGI/NAV data block	EGI range GPS based if INS fails, removed if subsystem fails
Chronometer	Remains displayed
Bank scale and arrow, side slip symbol	Side slip and bank indicator removed
Heading scale and indicator	GPS ground track if INS fails, numbers removed if subsystem fails
Heading set marker (Mil Std HUD only)	Remains displayed
Bearing arrow (Mil Std HUD only)	GPS ground track based if INS fails, removed if subsystem fails
Selected course and range (F-16 HUD)	EGI range GPS based if INS fails, removed if subsystem fails
Selected course and range (Mil Std HUD)	EGI range GPS based if INS fails, removed if subsystem fails
Avionics master mode/submode	Remains displayed
Maximum g (F-16 HUD only)	Remains displayed
Current Mach/groundspeed/TAS	Ground speed GPS based if INS fails, removed if subsystem fails. GS replaced by TAS on F-16 HUD if subsystem fails
Weapon delivery status	Remains displayed
Commanded velocity vector	Removed
Airspeed scale/dial and indicator	Remains displayed
Flight director	Removed
Current AOA	Remains displayed
Current G	Removed
Localizer raw data	Remains displayed
Glideslope raw data	Remains displayed unless SCA is PNS
AOA symbol (staple)	Remains displayed
Vertical velocity scale/digital readout	Removed
2.5° pitch/dive line	Remains displayed
VOR bearing arrow/radial readout	Remains displayed unless EGI/SCA/ILS/LOC/BC is PNS
Time to go	Removed

Figure 3-19. MFD AND HUD DISPLAYS AFTER EGI FAILURE - INS OR SUBSYSTEM FAILURE (Sheet 2)

HUD AND/OR UFCP FAILURE**NOTE**

- With HUD only failure:
Check RCP circuit breaker panel (right console) status to verify HUD circuit breakers are in.
- With UFCP only failure:
AAP - BOTH must be selected to enable UHF, TACAN, and NAV Backup Control Panels.

AC power transients (generator reset or successful crossover after generator failure) may cause HUD blanking for 3-5 seconds. The HUD reappears at default brightness level, which may be too dim for daylight operations and not visible. UFCP display may flash and disappear. HUD brightness level and normal UFCP display recovery should be attempted before assuming HUD/UFCP failure.

1. UFCP RTN key - PRESS
2. HUD brightness level - CHECK
3. TST function key - PRESS
4. UFCP ON/OFF switch - OFF THEN ON (WAIT 5 SECONDS FOR HUD/UFCP TO RE-INITIALIZE)

CAUTION

With HUD only failure or UFCP only failure, current and projected in flight conditions (to include destination weather) should be considered prior to cycling UFCP power.

If HUD/UFCP still failed -

5. Backup Mode Control Knob - BOTH

NOTE

BOTH must be selected to control UHF, NAV and TACAN Backup Control Panels if UFCP failed.

6. Land as soon as practical.

MFD FAILURE

1. MFD O/N/D switch - OFF THEN DAY OR NIGHT (AS APPROPRIATE)

If MFD still failed -

2. MDP switch - OFF THEN ON

CAUTION

Current and projected in flight conditions (to include destination weather) should be considered prior to cycling MDP power.

MAIN AUDIO MODE FAILURE

1. ACP audio backup switch - B/U (BOTH COCKPITS)

If still no audio -

2. Land as soon as practical.

MDP DEGRADED

1. PFL - NOTE DEGRADED EQUIPMENT
2. Displays - CHECK FOR BLANK OR FROZEN DATA
3. Revert to standby instruments for any failed data.
4. Use FCP backup control panel for communication and navigation functions as necessary.
5. MDP switch - OFF THEN ON
REFER TO MDP REBOOT (COLD BOOT)

CAUTION

Current and projected in flight conditions (to include destination weather) should be considered prior to cycling MDP power.



T38002-183-2-021

Figure 3-20. MFD Backup Display

MDP FAILURE

NOTE

If MDP fails, check center pedestal circuit breaker panel for a popped MDP circuit breaker.

When the MDP fails the following occur:

- No HUD display.
- No UFCP operation.
- MFD changes to backup mode (PFR and CDI raw data only), Figure 3-20.
- EGI reverts to backup navigation mode.
- Communications and navigation functions operate via FCP B/U control panels.
- VTR recording stops and DTS is not available.
- No MDP generated audio or visual warnings or caution lights.
- PFL inactive.
- No TCAS aural warnings or displays on B/U PFR display.
- No avionic failure displays.
- No pilot IBIT.
- HOTAS functions are indicated as follows:

Switch/Function	Active	Not Active
Mic switch	X	
Nosewheel steering	X	
Speed brake	X	
Trim button	X	
A/G target designation		X
CMD switch		X
Default display		X
Master mode		X
Trigger		X
Weapon mode		X
Weapon release		X

System will switch to backup mode automatically. Ensure UHF & NAV Backup Control Panels are illuminated.

NOTE

If MDP fails, check center pedestal circuit breaker panel for a popped MDP circuit breaker.

- MDP switch - OFF THEN ON (REFER TO MDP REBOOT [COLD BOOT]).

If MDP still failed and system does not switch automatically -

- Backup mode control knob - BOTH
- Proceed to VMC as soon as possible.
- Land as soon as practical.

MDP REBOOT

During MDP reboot, MFDs will revert to backup display.

If MFD in backup display for approximately 10 seconds (warm boot) -

- UFCP TCAS (IFF) data - RESET
- VTR - CHECK
- SAS - CHECK
- UFCP ALT KEY display - CHECK
- EGI steerpoint - CHECK
- BULLSEYE - CHECK
- TOT data - CHECK

If MFD in backup display for approximately 60 seconds (cold boot) -

- UFCP TCAS (IFF) data - RESET
- VTR - CHECK
- SAS - CHECK
- UFCP ALT KEY display - CHECK
- EGI steerpoint - CHECK
- BULLSEYE - CHECK
- TOT data - CHECK
- UFCP SET KEY display - CHECK

NAV FAILURE

Operational failures can occur in the NAV system if a navigation frequency fails to tune because of an internal system failure when changing frequency or changing PNS. When this occurs the AVIONICS caution flashes on the HUD and MFD.

If the DME fails to tune to the channel commanded by the VOR/ILS within 3 seconds, a PFL is generated indicating the DME failed to tune. If the PNS is ILS and ILS is selected at UR-4 of the NAVAID Sub-Menu Display, the reported DME channel is displayed at window 5 of the MFD NAV data block and the reported range is displayed in the MFD range data block. The range is not displayed in the MIL-STD HUD and F-16 HUD.

T.O. 1T-38C-1

If the PNS is VOR and it fails to tune, then the range is not displayed in window 2 of the MFD range data block or on the HUD. The reported channel is not displayed on the MFD or HUD. There is no UFCP display for VOR autopaired DME and no indication on the UFCP when the VOR autopaired DME fails to tune.

If TACAN is the PNS, window 2 of the UFCP BASIC Menu Display displays the current commanded TACAN channel and the letter T or A as appropriate. If the TACAN fails to tune, the unmatched commanded channel blinks. If the NAVAID Sub-Menu Display is selected, the TACAN window displays the channel that is tuned. When TCN or AAT is selected, the selected channel blinks until the selected channel and the reported channel match.

NAV FAILURE TO TUNE

If VOR/ILS/TACAN fails to tune during frequency or PNS change –

1. AAP backup mode control knob - NAV B/U

VOR/ILS/TACAN FAILURE

1. Appropriate B/U control panel - CYCLE POWER OFF THEN ON

If VOR/ILS/TACAN still failed -

2. AAP backup mode control knob - NAV B/U
3. Use EGI navigation.

TCAS (IFF) FAILURE

1. Verify transponder operation with air traffic control.

If transponder not responding -

2. AAP TCAS switch - CYCLE OFF THEN ON
3. UFCP TCAS (IFF) data - RESET

If transponder still not responding -

4. Continue mission consistent with airspace restrictions.

NOTE

After a short (50-300 msec) power interrupt, the MDP commands the TCAS to STBY mode.

UHF DEGRADE

If static causes UHF reception to become unreadable -

1. COMM ANTENNA - UPPER
2. ACP UHF volume control knob - MIN
3. VHF - SELECT
(ESTABLISH COMMUNICATIONS ON APPROPRIATE VHF FREQUENCY.)

If radio still unusable -

4. AAP Backup mode control knob - UHF B/U
(SELECT APPROPRIATE FREQUENCIES VIA UHF BACK UP CONTROL PANEL.)

UHF TOTAL FAILURE

1. COMM ANTENNA switch - UPPER OR LOWER
2. UHF Backup Control Panel - CYCLE OFF THEN ON

IF UHF still failed -

3. AAP Backup mode control knob - UHF B/U

VHF TOTAL FAILURE

1. NAV Backup Control Panel - CYCLE POWER OFF THEN ON

OTHER EMERGENCIES

EMERGENCY ENTRANCE

See Figure 3-21.

NORMAL ENTRANCE (LEFT SIDE OF FUSELAGE)

- 1 PUSH TWO LATCHES TO OPEN DOOR.
- 2 PULL HANDLE (OR HANDLES) OUT UNTIL ENGAGED.

NOTE
A MODERATE FORCE IS REQUIRED TO ROTATE HANDLES.

- 3 ROTATE HANDLE (OR HANDLES) FULLY CLOCKWISE TO UNLOCK AND RAISE CANOPY TO FULL OPEN.

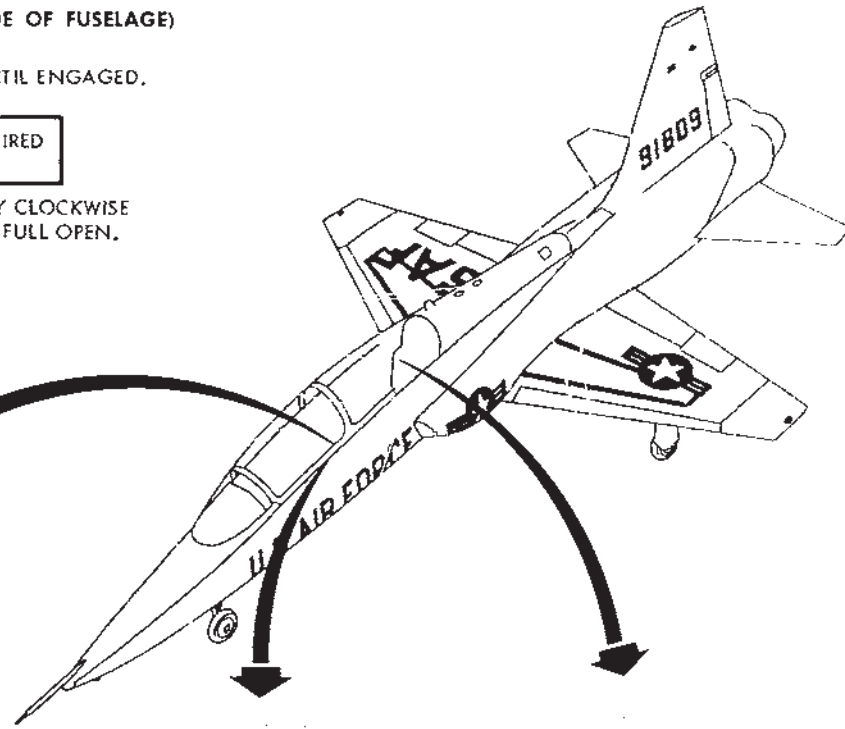
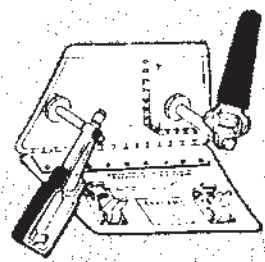

CANOPY JETTISON ENTRANCE (EITHER SIDE OF FUSELAGE)

WARNING

Do not use this method when residual fuel is around cockpit area.

- 1 PUSH LATCH TO OPEN DOOR.
- 2 PULL D-HANDLE OUT TO FULL LENGTH (APPROXIMATELY 6 FEET).

NOTE
BOTH CANOPIES ARE JETTISONED WHEN EMERGENCY D-HANDLE IS PULLED.

IF UNABLE TO OPEN CANOPY

BREAK CANOPY BEHIND PILOT/AIRCREW WITH AX OR SIMILAR IMPLEMENT.

NOTE
SPRAYING CANOPY WITH CO₂ WILL CAUSE THE GLASS TO BECOME BRITTLE AND EASY TO BREAK.

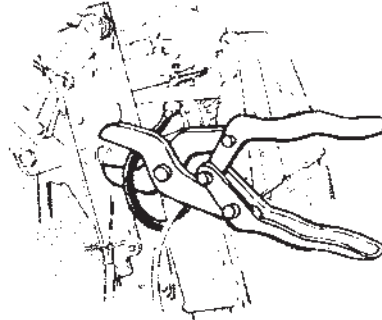
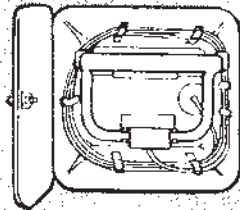

AFTER ACCESS TO COCKPIT IS GAINED

WARNING

Inadvertent seat jettison is possible if handgrips are raised.

CUT CATAPULT HOSE AND DROGUE GUN INITIATOR HOSE, USING WISS BULLDOG SHEARS NO. 5 OR BOLT CUTTER.

NOTE
IF HANDGRIPS HAVE NOT BEEN RAISED, INSERT SAFETY PIN IN RIGHT EJECTION SEAT LEGBRACE TO PREVENT INADVERTENT EJECTION.

T38002-23-1-020

Figure 3-21. Emergency Entrance

SECTION IV

CREW DUTIES AND PROCEDURES

NOT APPLICABLE

SECTION V

OPERATING LIMITATIONS

TABLE OF CONTENTS

	Page
General.....	5-1
Minimum Crew Requirement.....	5-1
Instrument Markings.....	5-1
Engine Operating Limitations.....	5-1
Throttle Setting Thrust Definitions	5-1
Airspeed Limitations	5-1
EED Displays	5-4
Load Factor Limitations	5-7
Prohibited Maneuvers	5-7
Miscellaneous Limitations	5-9
WSSP Limitations.....	5-10

GENERAL

All limitations that must be observed during normal operations are covered herein. Some limitations that are characteristic of only a special phase of operation (emergency procedures, flight through turbulent air, etc.) are not covered here; however, they are included with the discussion of the operation in question.

NOTE

All references to airspeed quoted in knots refer to calibrated airspeed.

MINIMUM CREW REQUIREMENT

The minimum crew requirement for this aircraft is one pilot. Solo flights must be made with the pilot flying the aircraft from the front cockpit.

INSTRUMENT MARKINGS

Aircrew must understand instrument markings in Figures 5-1 and 5-2, since they represent limitations that are not necessarily repeated in the text.

ENGINE OPERATING LIMITATIONS

See Figure 5-3.

THROTTLE SETTING THRUST DEFINITIONS

NORMAL THRUST

Normal (maximum continuous) thrust is the thrust obtained at 98% RPM or 630°C EGT, whichever occurs first.

MILITARY THRUST

MIL thrust is the thrust obtained at 100% RPM without afterburner operation.

MAXIMUM THRUST

MAX thrust is the thrust obtained at 100% RPM with the afterburner operating. Afterburner range extends from minimum afterburner of approximately 5% augmentation above MIL thrust to maximum afterburner, which is approximately 40% augmentation above MIL thrust.

AIRSPEED LIMITATIONS

MAXIMUM ALLOWABLE AIRSPEED

Do not exceed the maximum allowable airspeed of 710 knots equivalent airspeed.

T.O. 1T-38C-1

FLAPS



High speed flap deflection can result in an instantaneous failure of one or both flaps. If one flap fails, the sudden asymmetric condition will result in a severe coupled roll and yaw possibly associated with high negative G's. Immediately return the flap lever to the UP position to ensure recovery.

NOTE

Detection of unintentional flap deployment at high speed is critical to avoiding a flap failure. Upon flap deflection, there will be an uncommanded pitch down associated with a noise of rushing air and possible buffet. If this condition occurs, immediately return the flap lever to the UP position.

Do not exceed the following airspeeds for the flap deflections:

1 % to 45 %	300 KCAS
46 % to 60 %	240 KCAS
Over 60 %	220 KCAS

LANDING GEAR

Do not exceed 240 KCAS with the landing gear extended and/or landing gear doors open.



Extension/retraction of landing gear at bank angles greater than 45° or at load factors greater than 1.5 g can result in overstress failure of the main landing gear sidebrace trunnion.



Figure 5-1. Electronic Engine Display (EED)





OXYGEN PRESSURE

 50 TO 120 PSI NORMAL RANGE



HYDRAULIC PRESSURE

 1500 PSI MINIMUM
 2850 TO 3200 PSI NORMAL RANGE
 3200 PSI MAXIMUM

T38002-226-1-020

Figure 5-2. Instrument Markings

NOSEWHEEL STEERING

Do not exceed 65 knots ground speed with nosewheel steering engaged.

CANOPY

Do not exceed 50 KCAS while taxiing with a canopy open.

Avoid taxi operations with an open canopy with a relative wind greater than 30 knots (relative wind is defined as ground speed plus wind component over the nose).

EED DISPLAYS

ENGINE TACHOMETER (RPM)

The display format is as follows:

a. Analog RPM scale with tic marks equally spaced at 10 % RPM intervals. The tic marks are white except for the arcs adjacent to the numerals 5 and 10, which are light green. The tachometer readings represent percent of maximum RPM.

b. A pointer indicating the current RPM. The color of the pointer is white during normal operations and turns red when RPM limits are exceeded.

c. A white center digital readout that displays up to three digits, from 0 to 110 % in 1 % increments.

- d. Sections of the perimeter are colored as follows:
- (1) Light green arc: 46-50 % (only when WOW)
 - (2) Dark green arc: 99-101 %
 - (3) Dark green arc: 101-104 % (only when weight off wheels)

e. One longer red tic mark is located at the 107 % point.

f. Title RPM is white during normal operations and latches red when RPM limits are exceeded.

ENGINE EXHAUST GAS TEMPERATURE (EGT)

The display format is as follows:

a. An analog scale with white tic marks spaced around the dial.

b. A pointer indicating the current EGT. The color of the pointer is white during normal operations and turns red when engine EGT overtemperature occurs.

c. A digital readout displays up to four digits, from 0-1200°C in 5° increments. The color of the digital readout is white during normal operations and turns red when engine EGT overtemperature occurs.

d. A dark green arc from 630-645°C.

NOTE

EGT limits are 630-650°C for MIL/MAX power.

e. Long white tic marks at 0 and 140°C.

f. Long red tic marks at 845 and 925°C.

g. Title EGT is white during normal operations and latches red if engine EGT overtemperature occurs.

NOZZLE POSITION (NOZ)

The display format is as follows:

a. An analog scale with associated pointer scale indicators equally spaced at 20 % intervals. White tic marks are equally spaced at 10 % intervals. The nozzle position readings represent percent of maximum nozzle position.

- b. A white indicator points to the current nozzle position.
- c. A white center digital readout that displays from 0 to 99% in 1% increments.
- d. Title NOZ (white).

FUEL FLOW (FF)

The display format is as follows:

- a. Two white analog scales, one for each fuel system, with a tic mark at 360 PPH and additional tic marks spaced every 1000 PPH.
- b. Two white solid bar indicators for reading against the scale, one for each fuel system.
- c. Green bands indicating 400-600 PPH and 2100-2500 PPH.

NOTE

PMP aircraft fuel flow limits in MIL power are 2100-2700 PPH.

- d. On the bottom of each scale, a digital representation of the fuel flow of each individual system is displayed in 20 PPH increments (white).

NOTE

The increased fuel flow during afterburner operation is not provided to, or displayed by the EED.

- e. Title FF (white).

ENGINE OIL PRESSURE (OIL)

The display format is as follows:

- a. An analog scale with tic marks equally spaced around the dial at 10 PSI intervals, and numerical dial indicators at 20 PSI intervals. The tic marks are white except for the tic mark adjacent to the 10 psi point which is light green and the tic mark adjacent to the 20, 30, 40, and 50 PSI points which are dark green.
- b. An analog pointer indicating the current oil pressure. The color of the indicator is as follows:

White	5-55 PSI
-------	----------

Red	Above 55 PSI or below 5 PSI (refer to Electronic Engine Display (EED) section I)
-----	--

- c. A white digital readout that displays up to two digits in 1 PSI increments. The color of the display is white.

- d. Different sections of the dial have unique colors as follows:

- (1) Light green arc - 5-19 PSI
- (2) Dark green arcs - 20-55 PSI

- e. Two longer red tic marks are displayed, one at the 55 PSI point and one at the 5 PSI point.

- f. Title OIL:

White	5-55 PSI
Red	Above 55 PSI or below 5 PSI [refer to Electronic Engine Display (EED) section I]

FUEL QUANTITY (FQ)

The display format is as follows:

- a. Two white analog scales, one for each fuel system, with tic marks at every 100 pounds and numerical indicators spaced at 500-pound intervals, labeled in hundreds.

- b. Two solid bar indicators for reading against the scale, one for each fuel system. The color of the bar is white unless the quantity of a system is below 250 pounds for more than 7.5 seconds, then the bar turns to red and the cockpit LOW FUEL warning light illuminates. The bar returns to white when the quantity is greater than 250 pounds and the cockpit LOW FUEL warning light turns off.

- c. On the top of the scale, the total usable fuel quantity (white) in both systems is displayed in 10-pound increments.

- d. On the bottom of each scale, the fuel quantity (white) of each individual system is displayed in 10-pound increments.

- e. Fuel imbalance indication. A digital display of the fuel quantity difference with a leading + sign is displayed in 10-pound increments under the bar of the system with a greater fuel quantity. The maximum display is +910 pounds. The imbalance indication color is as follows:

- (1) 0-50 pound difference - no display
- (2) 60-190 pound difference - white
- (3) 200 pounds and above difference - red

- f. Crossfeed indicator. When the CROSSFEED switch is ON, the tops of the two bars are attached with a solid magenta line.

ENGINE OPERATING LIMITATIONS

CONDITION	EGT °C	RPM %	NOZZLE POSITION %	FUEL FLOW LB/HR	OIL PRESSURE PSI	TIME DURATION (MINUTES)
GROUND STEADY STATE						
START	1 925 (MAX) 845	---	---	3 360 (MAX)	0	---
IDLE	---	46 - 50	77 - 92	400 - 600 (STD DAY)	5 - 20	---
MILITARY	630 - 650	99 - 101	0 - 20	2100 - 2700 (SEA LEVEL)	20 - 55	5
(MAX) AFTERBURNER	630 - 650	99 - 101	50 - 85	---	20 - 55	5
FLIGHT STEADY STATE						
START	1 925 (MAX)	---	---	3 360 (MAX)	0	---
IDLE	---	---	---	200 (MIN) (STD DAY)	5 (MIN)	---
MILITARY	630 - 650	99 - 104	0 - 20	---	20 - 55	30
(MAX) AFTERBURNER	630 - 650	99 - 104	50 - 85	---	20 - 55	15
FLUCTUATION LIMITS (WITHIN STEADY STATE LIMITS)						
IDLE	---	46 - 50	NONE ALLOWED	±25	±2	---
MIL AND AB (GROUND)	2	99 - 101	±3	±50	±2	---
MIL AND AB (FLIGHT)	2	±1	±3	±50	±2	---

SEE S-2

SEE S-2

OTHER LIMITATIONS



To avoid engine damage, abort sortie if EED RPM, EGT or OIL title latches red.

EGT:

- 1 1. Abort start if EGT reaches 845°C to preclude exceeding temperature limits.
- 2. Abort aircraft during ground start if EGT exceeds 925°C momentarily.
- 2 3. Total fluctuations in EGT of 15°C (±7.5°C) are acceptable if the average EGT is between 630°C and 650°C.
- 4. At low compressor inlet temperatures, military and afterburner EGT and RPM may be below normal operating limits.

RPM:

- 1. Maximum allowable transient RPM is 107%.

NOZZLE POSITION:

- 1. Following rapid throttle movements, nozzle position should stabilize within permissible fluctuation range within 10 seconds.
- 2. Nozzle position may be less than 50% when operating the afterburner at less than MAX AB.

FUEL FLOW:

NOTE

Non-PMP aircraft fuel flow limits in MIL power are 2100-2500 PPH.

- 3 1. During engine start the indicated fuel flow may momentarily transit above 360 pph after advancing the throttle to idle during engine sequence but should return to equal to or less than 360 pph prior to EGT rise during actual engine start.

OIL PRESSURE:

- 1. During cold weather starts, oil pressure usually exceeds 55 PSI. To expedite oil warmup, engine may be operated at MIL power or below (do not exceed 5 minute time limit in MIL power). If oil pressure does not return to operating limits within 6 minutes after engine start, shutdown engine.
- 2. If a sudden change of 10 PSI or greater in oil pressure indication occurs at any stabilized RPM, follow engine OIL SYSTEM MALFUNCTION procedures in section III.

TIME DURATION:

- 1. Cool down the affected engine(s) at 70% power for 3 minutes between repeated ground engine runs.

Figure 5-3

LOAD FACTOR LIMITATIONS

Do not exceed the following (see Figures 5-4 and 5-5).

SYMMETRICAL FLIGHT

Load Factor (g)	Weight of Fuel Remaining (Pounds)
-2.3 to +5.7	3500
-2.4 to +5.9	3000
-2.6 to +6.5	2000
-2.9 to +7.2	1000

ASYMMETRICAL FLIGHT

Load Factor (g)	Weight of Fuel Remaining (Pounds)
0 to +4.1	3500
0 to +4.3	3000
0 to +4.7	2000
0 to +5.0	1000

SPECIAL FLIGHT LIMITATIONS

Functional Check Flights (FCFs) and one-time ferry flight authorizations may require limitations or operation different from standard. Prior to flying an aircraft for these missions, a briefing should be

received from appropriate maintenance (quality control) and/or operations personnel. T.O. 1T-38A-3 contains requirements for one-time ferry flights and other special instructions. Certain conditions could exist which may allow continuous operation with restrictions. These conditions and restrictions shall be noted and flight approval from the using command shall be required. These aircraft will be identified by a placard on the cover or the AFTO 781 and cockpit placards.

PROHIBITED MANEUVERS

VERTICAL STALLS

Vertical stalls are prohibited.

SPINS

Intentional spins are prohibited. Refer to section VI for spin recovery procedure in case an inadvertent spin is experienced.

ROLLS

Continuous aileron rolls (more than one complete roll) will be accomplished only at 1.0g and $\frac{3}{4}$ or less stick deflection. Single aileron rolls may be accomplished at any load factor or stick deflection if asymmetric g limits are observed.

SYMMETRICAL FLIGHT

DATE: 1 MARCH 1970
DATA BASIS: FLIGHT TEST

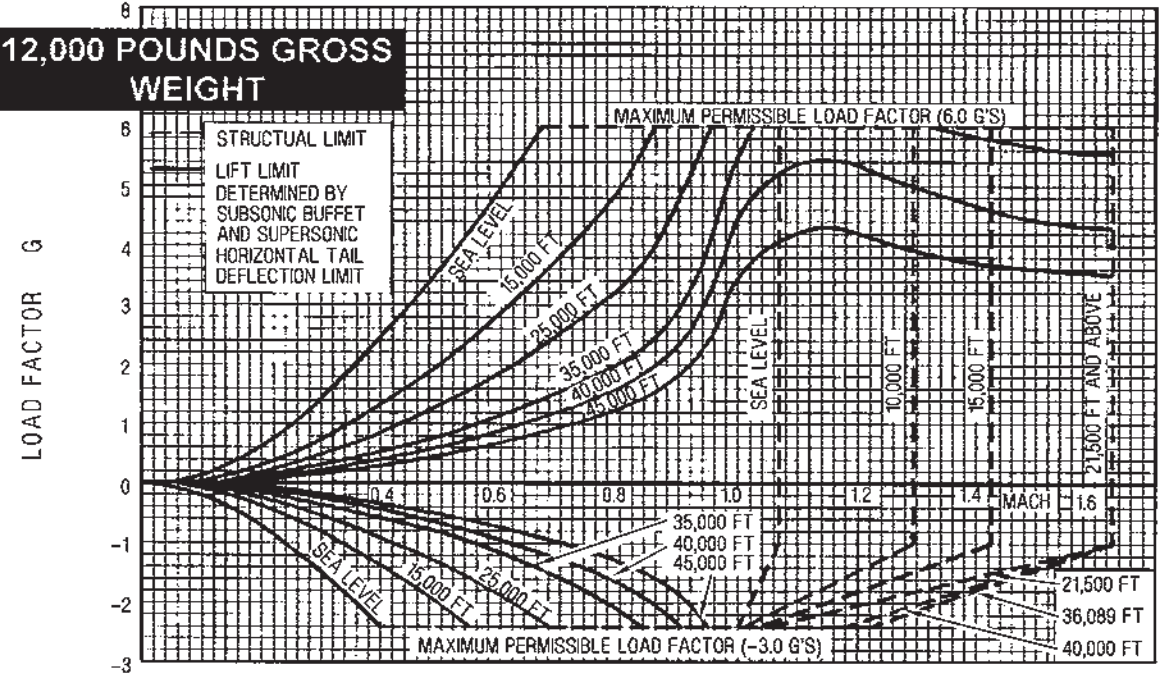
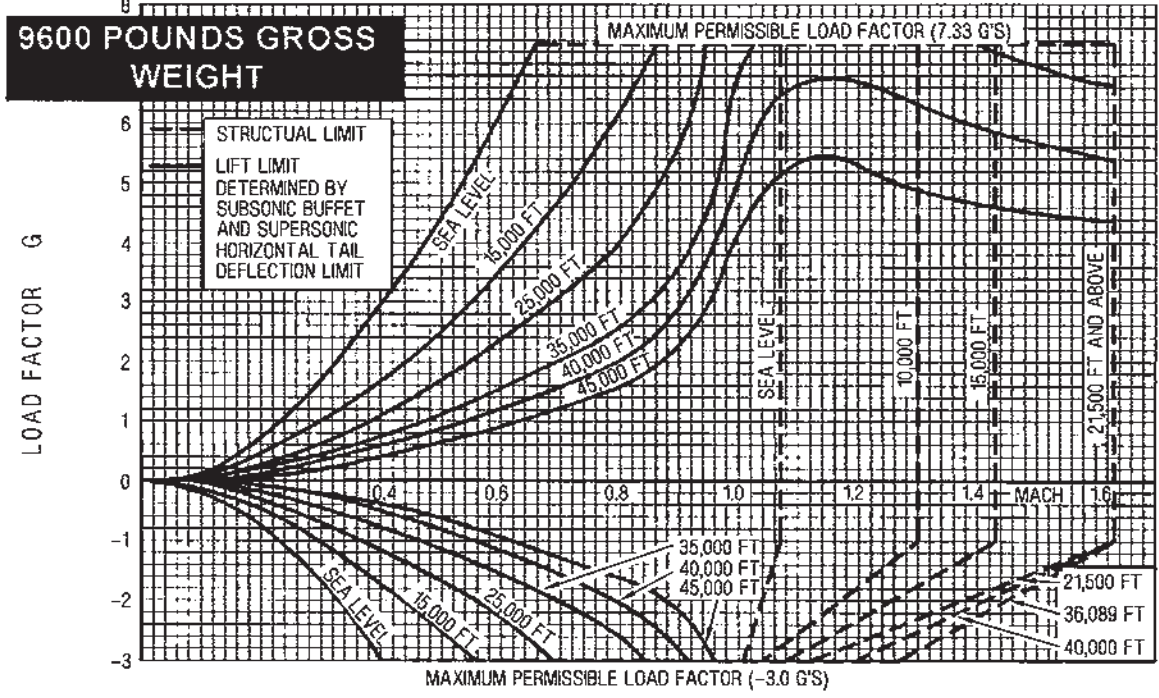

Figure 5-4. Operating Flight Strength

138302 5 3 29

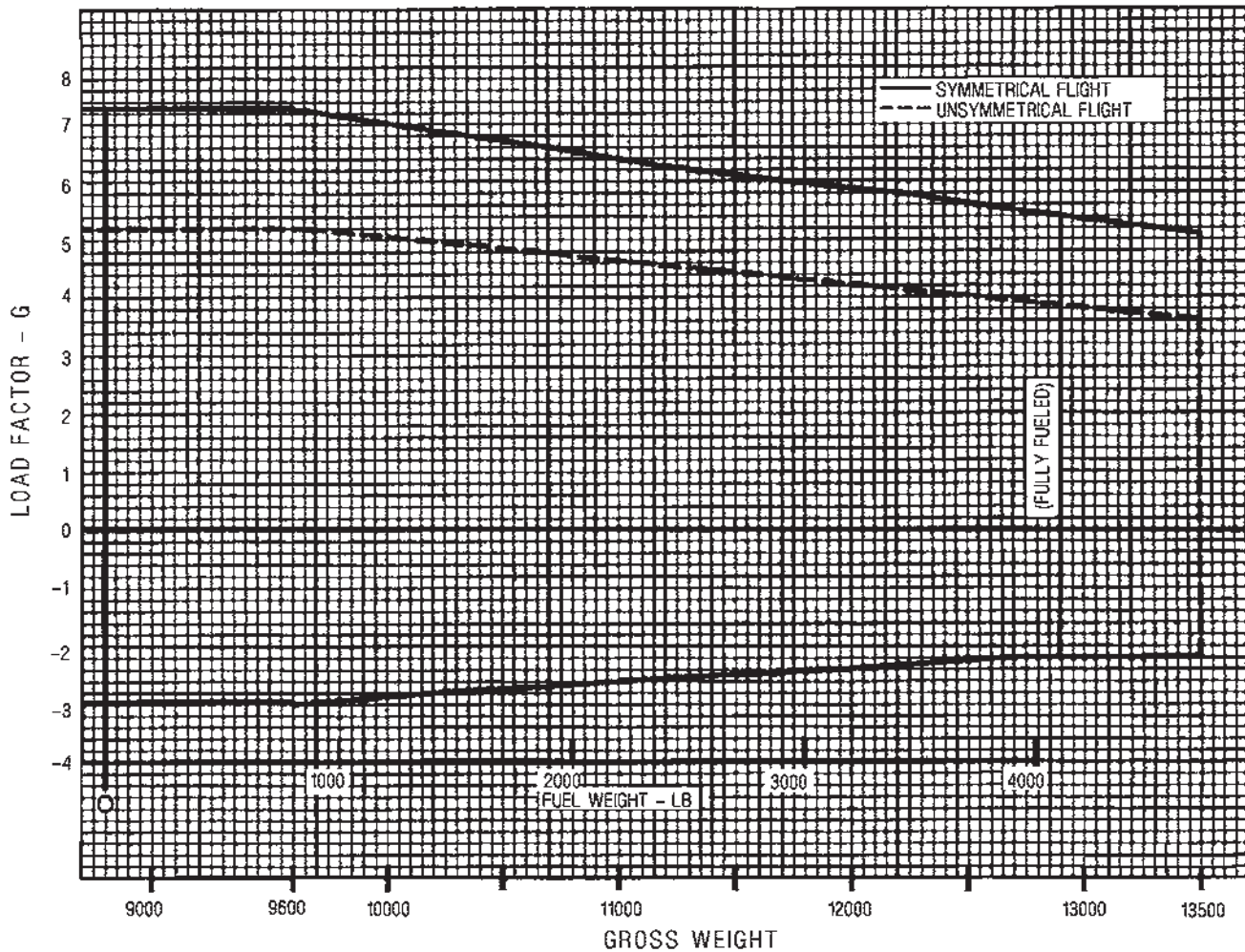

Figure 5-5. Maximum Permissible Load Factor

MISCELLANEOUS LIMITATIONS

pounds of fuel in either supply system, time for successful engine operation is further reduced.

FUEL SYSTEM

To prevent fuel starvation and subsequent engine flameout, do not exceed the following.

- a. Maximum thrust dives with less than 650 pounds of fuel in either fuel supply system.
- b. Maximum thrust power in zero g flight or at negative load factors exceeding 10 seconds at 10,000 feet or 30 seconds at 30,000 feet. With less than 650

NOTE

Lower power settings will result in proportionally longer operating times; however, do not exceed engine oil system supply limitations.

ENGINE OIL SYSTEM

Due to engine oil supply and pressure requirements, zero-g flight is restricted to 10 seconds and negative-g flight (any attitude) to 30 seconds. A momentary drop or loss of oil pressure may be experienced during

T.O. 1T-38C-1

negative-g or inverted flight. Engine oil venting overboard and/or low oil pressure may occur until positive g loads are applied.



If oil pressure does not recover within approximately 10 seconds, return to normal flight conditions. Do not attempt zero-g or negative-g maneuvers again until oil pressure registers at a normal value for at least 30 seconds.

WHEEL BRAKES AND TIRES

If the following minimum time intervals between full stop landings cannot be complied with, brakes, wheels and tires should be allowed to cool with the aircraft parked in an uncongested area and the condition reported in AFTO Form 781.

Minimum Time Interval Between Full Stop Landings

Gear retracted in flight.....45 minutes

Gear extended in flight.....15 minutes

NOSEWHEEL TIRE

The nosewheel tire is rated to 174 knots groundspeed.

MAIN WHEEL TIRE

The main wheel tire is rated to 204 knots (14 ply) or 195 knots (12 ply) groundspeed.

LANDING RATE OF DESCENT

Landing should be made with as low a sink rate as practicable. Do not exceed the following sink rates at touchdown:

a. 590 fpm normal landing, 395 fpm crab landing, with less than 1700 pounds of fuel.

b. 340 fpm normal landing, 200 fpm crab landing, with full fuel.

WEIGHT AND CENTER OF GRAVITY LIMITATIONS

The weight and balance limitations cannot be exceeded by normal operating or loading conditions; however it is possible to attain an aft CG when the right fuel system contains more fuel than the left fuel system. To avoid exceeding the aft CG limit during solo flight, do not allow the right (aft) fuel system quantity to equal more than twice the left (forward) fuel system quantity. If this should occur, longitudinal static stability is reduced and caution should be exercised to prevent overcontrolling during high speed subsonic flight or landings.

HYDRAULIC PRESSURE

Hydraulic pressure readings outside normal range with no demand on the respective system are indicative of a malfunction within the system. High pressures pose the greater danger because of possible fluid overtemperatures. However, operating hydraulically powered equipment (e.g., making rapid flight control movements) will cause pressure fluctuations well outside the static limit. These fluctuations are not considered a malfunction.

WSSP LIMITATIONS

See Figure 5-6.

NOTE

For T-38C PMP modified aircraft operating above FL 300 and 0.92 Mach, with a WSSP installed, the aircraft can experience a slight reduction in lateral directional stability. Turbulent air makes this condition more pronounced. If this condition is encountered, reduce airspeed to below 0.92 Mach and use small rudder inputs as required.

STORE	AIRPEED LIMITATIONS	ACCELERATION-G		STORES CONFIGURATION WEIGHT LBS.	TOTAL DRAG INDEX (INCLUDING PYLON)	REMARKS
	CARRIAGE	CARRIAGE				
		SYM	UNSYM			
WSSP	400	+4.0 0.0	+3.0 0.0	E110 F250	25	Normal load capacity - 140 pounds. Carriage airspeed 350 KCAS in severe turbulence or with speed brake open. Avoid abrupt control movements over 240 KCAS.

Figure 5-6. WSSP Limitations

SECTION VI

FLIGHT CHARACTERISTICS

TABLE OF CONTENTS

	Page
Characteristics.....	6-1
Wake Turbulence	6-1
Stalls.....	6-1
Effect Of Bank Angle On Vertical Velocity	6-4
Spins.....	6-4
Flight Controls.....	6-5
Maneuvering Flight.....	6-6
High Speed Dive Recovery	6-7

CHARACTERISTICS

The addition of an external store shifts the CG forward. This results in increased rotation and lift-off speeds, reduced trim authority, higher aft stick forces, increased deceleration during flare for landing and reduced aerobraking capability.

WAKE TURBULENCE

Avoid wake turbulence. The aircraft, because of the short wingspan, is particularly susceptible to wake turbulence upset. The vortex-produced rolling moment can exceed aileron authority in the takeoff and/or landing configuration. The rapid changes in lift can result in a stall without sufficient altitude to recover.

STALLS

The stall is characterized by airframe buffet and a high sink rate rather than by a clean nose-down pitch motion. As AOA is increased, there is a corresponding increase in buffet intensity. The buffet is most severe with flaps fully extended. The stall condition is immediately preceded by heavy low-speed buffet and moderate wing rock. The wing rock can be controlled with rudder. The actual stall is normally not accompanied

by any abrupt aircraft motion, but is indicated only by the very high sink rate.

WARNING

If the stall condition is aggravated by abrupt control inputs, unusual aircraft attitudes may result.

STALL RECOVERIES

Stall can be terminated by relaxing back stick pressure, rolling wings level, and moving throttles to MAX simultaneously. If in the landing configuration, raise gear and speed brake, allowing flaps to remain extended until stall recovery has been accomplished. While it is normally not necessary to allow the nose to pitch down, relaxation of back pressure is critical in breaking the stall and allowing the aircraft to accelerate, reducing the buffet, eliminating wing rock, and maintaining adequate aileron control. Reducing the bank angle will lower the stall speed and decrease the sink rate (see Figure 6-1, 6-2, and the Effect of Bank Angle on Vertical Velocity charts in T.O. 1T-38C-1-1, Part 7 of the Appendix). Since timely identification of an actual stall is difficult, stall recovery should be initiated at the first indication of increasing buffet or rate of sink. Recovery from a stalled condition can be accomplished with a minimum loss of altitude using the above stall recovery technique.

WARNING

If a high sink rate condition is allowed to develop, excessive altitude loss will occur and recovery may not be possible at traffic pattern altitudes.

NOTE

Refer to ENGINE COMPRESSOR STALLS AND FLAMEOUTS, section I, for engine operating instructions during stall.

POWER - OFF (IDLE THRUST)
 LANDING GEAR UP OR DOWN
 SEA LEVEL TO 5,000 FT

MODEL: T-38
 DATE: 1 AUGUST 1965
 DATA BASIS: FLIGHT TEST

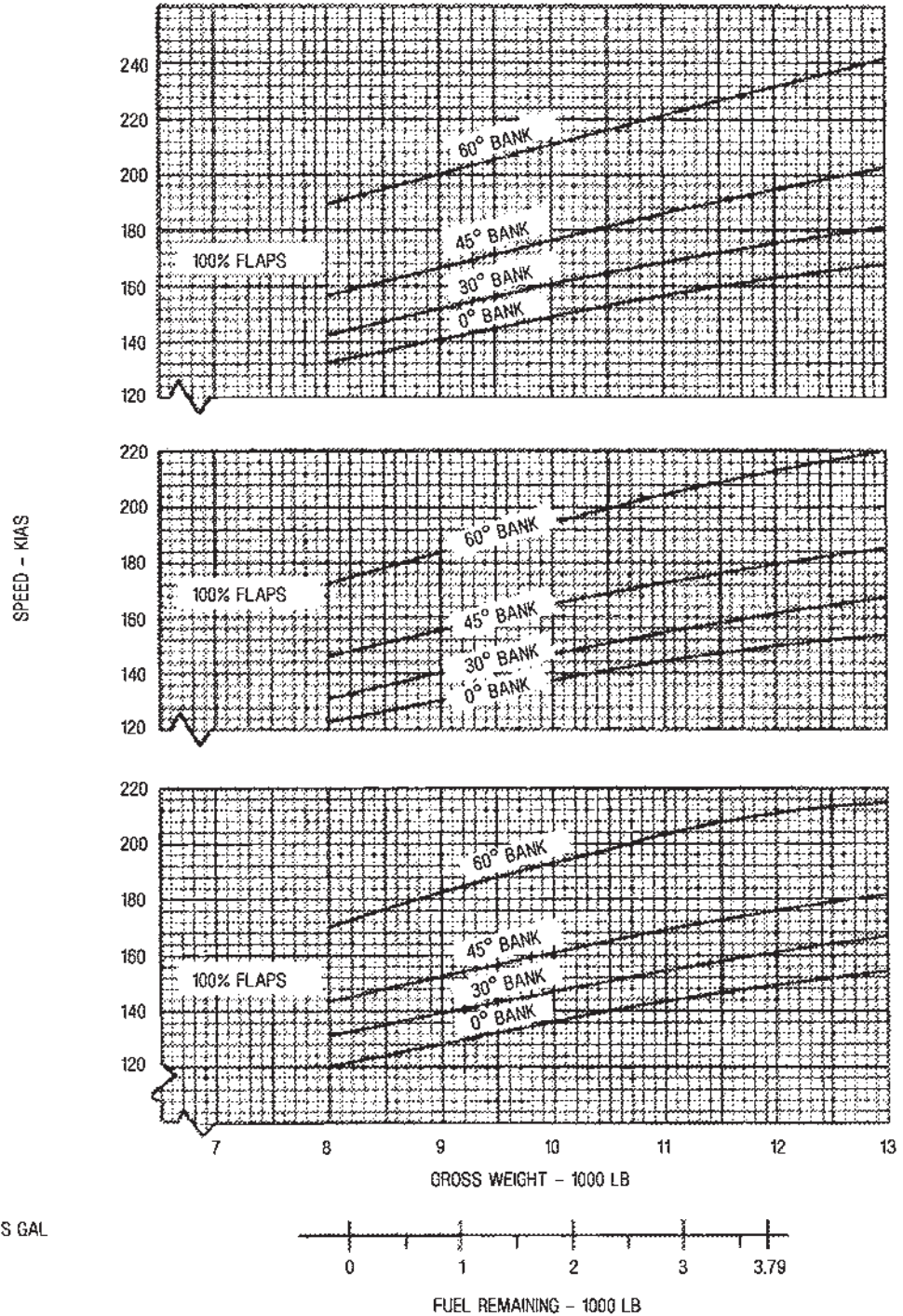

ENGINE: (2) J85-GE-5
 FUEL GRADE: JP-4
 FUEL DENSITY: 6.5 LB/US GAL

Figure 6-1. Stall Speed Chart

SEA LEVEL STANDARD DAY

60% FLAPS AND GEAR DOWN

DATE: 1 APRIL 1969
DATA BASIS: FLIGHT TEST

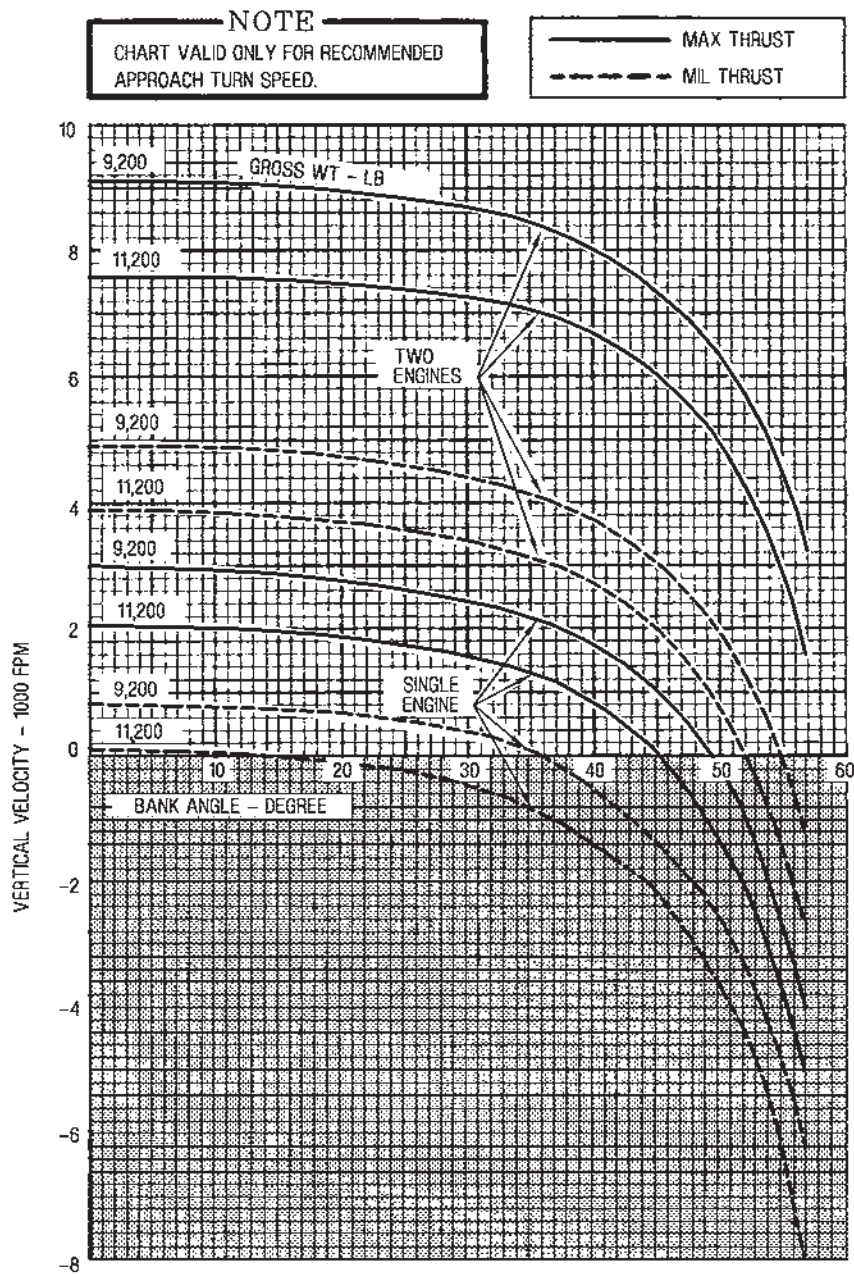

T38002-33-1-020

Figure 6-2. Effect of Bank Angle on Vertical Velocity

EFFECT OF BANK ANGLE ON VERTICAL VELOCITY

Steep bank angles during turn to final approach can cause a very rapid descent rate from which it may be impossible to recover. This is especially true for single engine approaches to landing. Figure 6-2 shows the effects of bank angle on vertical velocity for sea level standard day conditions for light and heavy aircraft gross weights at the recommended final turn speed. Single engine landing patterns should be planned so that steep bank angles are not required. A complete set of charts showing the effects of bank angle on vertical velocity for various conditions can be found in T.O. 1T-38C-1-1, part 7 of the Appendix.

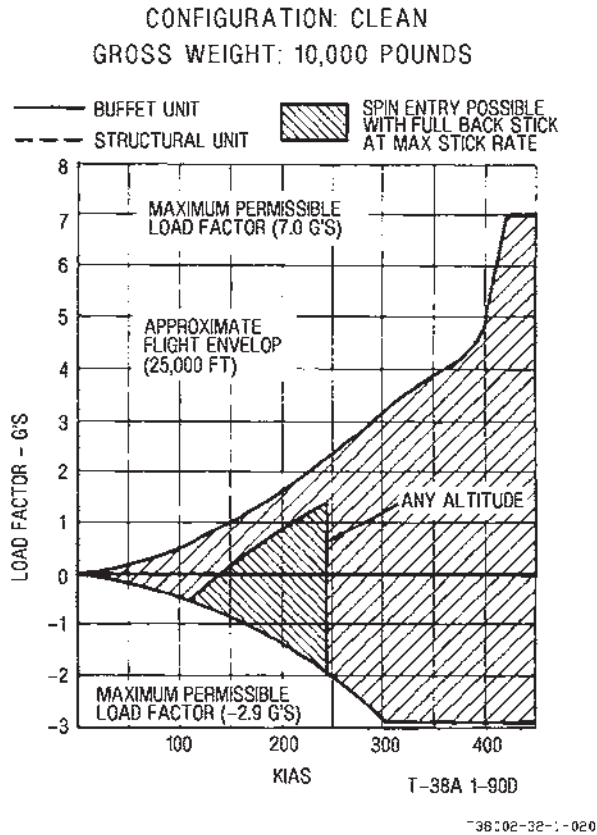

Figure 6-3. Area of Possible Spin Entry

SUBSONIC ACCELERATED STALLS

Accelerated stalls are similar to 1-g stalls.

POST STALL GYRATIONS

Gyrations can be experienced during 1-g stalls, inverted stalls (negative g, negative AOA and stick held forward), accelerated stalls and cross control stalls. These gyrations will not result in a spin (abrupt full aft stick movement at near maximum rate is required for spin entry). The corrective procedure for all unrecognizable gyrations is to smoothly neutralize controls until the aircraft settles into a recognizable maneuver or recovers. Expect a short period of erratic motion and/or negative load factors after controls are neutralized.

SPINS

The aircraft exhibits a high degree of resistance to spin entry; abrupt application of aft stick at close to maximum possible rates within the envelope shown in Figure 6-3 is required to enter a spin. Entry will occur without use of rudder. Normal flight maneuvers, if properly flown, will not cause a spin. During unusual maneuvers (e.g., collision avoidance), the pilot must be aware of airspeed and control inputs relative to those required for a spin entry.

WARNING

Abruptly applying spin recovery controls when the aircraft is not in an actual spin may cause a spin or extremely disorientating aircraft gyrations. Do not apply spin recovery controls unless a spin has been definitely diagnosed.

ERECT SPIN

Once an erect spin has developed, the spin will be flat and may be either oscillatory or very smooth. The aircraft may oscillate about all three axes, and the pilot will experience transverse g loads. Flameout of one or both engines can be expected.

Erect Spin Recovery

The primary antispin control is the aileron, and it is imperative that full aileron deflection be held during recovery.

WARNING

If full aileron deflection in the direction of the spin is not maintained throughout the recovery, spin recovery may be prolonged or prevented.

Immediately upon recognition of the direction of rotation, use the following procedure:

1. Control stick - FULL AILERON, USING BOTH HANDS, IN DIRECTION OF SPIN AND AS MUCH AFT STICK AS POSSIBLE WITHOUT SACRIFICING AILERON.
2. Rudder - FULL OPPOSITE TURN
3. Do not change gear, flaps, and speed brake positions during recovery.
4. Neutralize controls after recovery.

NOTE

Recovery from the spin is normally abrupt and may be followed by some spiraling during the resultant dive.

INVERTED SPIN

An inverted spin is very oscillatory about all axes and is easily recoverable.

Inverted Spin Recovery

Immediately upon experiencing an inverted spin, use the following procedure:

1. All flight controls - NEUTRALIZE

WARNING

- Maintain controls in neutral position throughout the spin recovery. Any aileron or rudder deflection can induce a transition to an erect spin.
- Ejection from either an erect or inverted spin is to be accomplished if a spin recovery is not completed by 15,000 feet above the terrain, or if transverse g loads preclude maintaining antispin controls, whichever occurs first.

FLIGHT CONTROLS

STABILITY AUGMENTATION

The stability augmentor system positions the rudder control surfaces to automatically damp out yaw short period oscillations. The aircraft may be flown safely throughout the flight envelope, Figure 6-4, without the stability augmentor system engaged.

G OVERSHOOT

The horizontal tail control system incorporates a bob-weight to increase stick forces under g loads. Since the pilot does not feel the effect of the bob-weight until the aircraft responds to the stick movement, g overshoots may occur if the stick is deflected too abruptly.

CAUTION

Abrupt forward or aft deflection or “pulsing” of the stick in the Mach range from 0.80 to 0.95 may result in overshoot of the limit load factor.

LATERAL CONTROL.

Aileron deflection does not increase proportionally with stick travel. The first 4.5 inches of stick travel provide $\frac{1}{2}$ aileron deflection, while the remaining 1.5 inches of stick travel provide full aileron deflection.

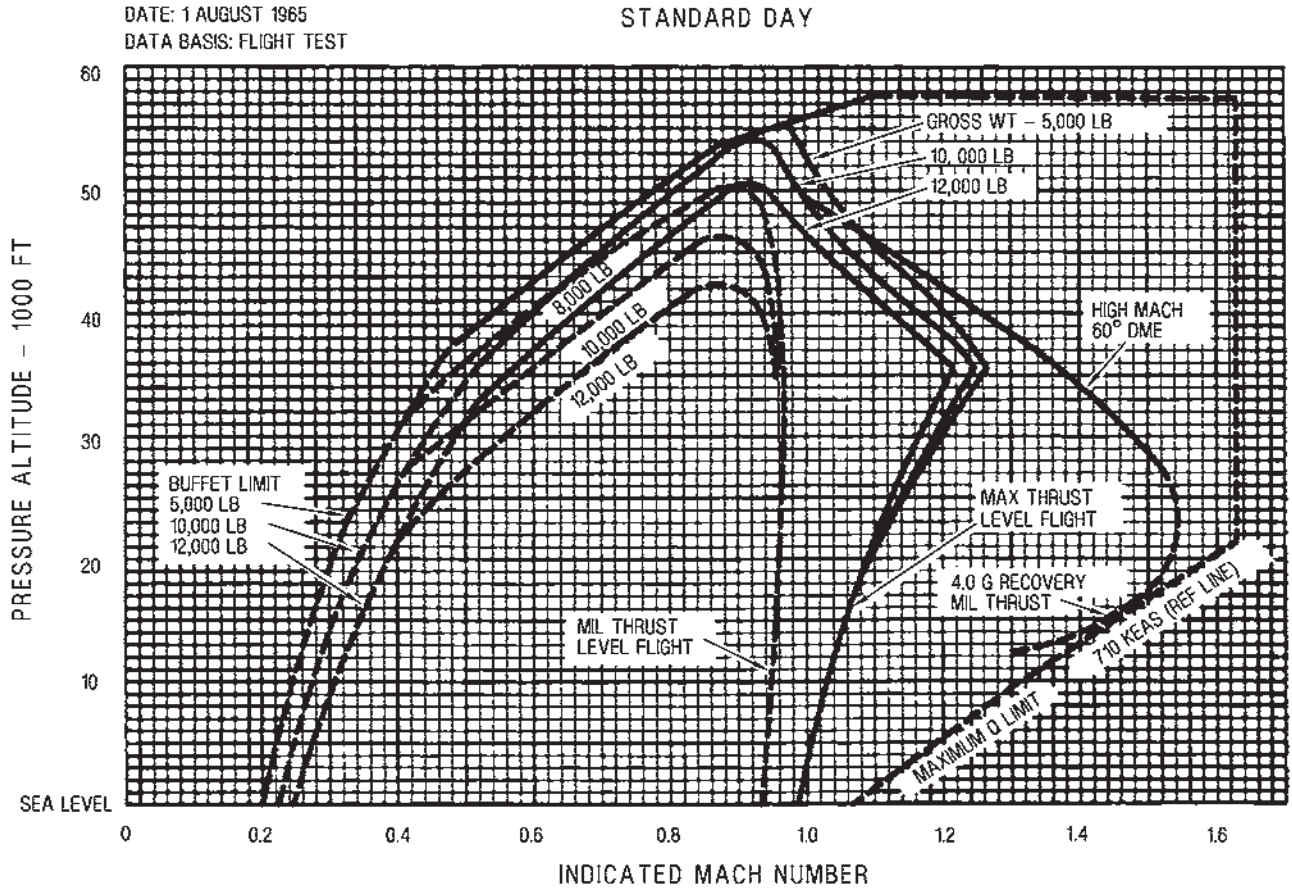

T38302-34-1-C2C

Figure 6-4. Flight Envelope

MANEUVERING FLIGHT

NOTE

Maneuvering and handling qualities are degraded at lower airspeeds; therefore, a minimum of 300 KCAS should be maintained until configuring for instrument approaches, or performing maximum range descents, landings and tactical maneuvering. The objective for establishing a minimum airspeed is to maintain a satisfactory energy state (i.e., g available that will provide desired recovery response if an undesirable flight parameter is encountered below 15,000 feet AGL).

STICK FORCES

Minimum stick forces per g occur at approximately Mach 0.9. Be careful not to over control when maneuvering near this airspeed so that the allowable load factor is not exceeded.

PILOT INDUCED OSCILLATIONS

The relationship between pilot response and aircraft pitch response in high subsonic-low altitude flight is such that over controlling may lead to severe pilot induced oscillations. The oscillation is characterized by a sudden and violent divergence in pitch attitude resulting in a very large positive and negative load factors which are actually made larger by the pilot attempting to control the oscillation. Because the basic aircraft is stable, the pilot should immediately release the stick so that the aircraft can damp itself or, if at very low altitude or close to another aircraft, the pilot should attempt to apply and rigidly hold back-pressure on the stick. In addition to the above, a reduction in airspeed will aid in recovery. It should be noted that if the pilot is not securely strapped into his seat, the above recovery procedures may be difficult to accomplish.

ROLLS

Roll rates obtainable in this aircraft, with full aileron deflection, are extremely high and could cause the

pilot to become disoriented. Caution should be exercised when using rudder in conjunction with aileron application during rapid roll or turn entry. Rapid input of both rudder and half (or more) aileron, can cause large load factor excursions during the maneuver.

EFFECT OF ANGLE OF ATTACK (AOA) ON ROLL PERFORMANCE

Aircraft roll response to control inputs (rudder and/or aileron) is directly affected by the aircraft angle of attack. The aircraft can be flown safely throughout the full AOA envelope. As AOA increases, the most effective surface to control the aircraft changes from aileron to rudder.

Due to wing airflow characteristics, the aileron is more effective rolling the aircraft at lower AOA. As AOA increases, roll rates for the same aileron deflection decreases.

Due to the aircraft swept wing design, the rudder is more effective rolling the aircraft at high AOA. As rudder is applied, the aircraft begins to yaw, increasing lift on the opposite wing, resulting in a roll in the same direction as the rudder deflection. As AOA increases, roll rates for the same rudder deflection increases.



With the gear down, using sustained 30° rudder deflection at high AOA may result in violent and excessively high rates of roll. Additionally the engines may stall, stagnate or flameout.

ASSYMMETRICAL G

Assymmetrical g forces occur anytime the aircraft has a roll rate. A phenomenon known as roll coupling can also superimpose an additional g increment during rolling maneuvers. In steady state banked coordinated flight (roll rate = 0), g forces are symmetrical. When evaluating g limit overshoots as a result of a wingtip vortex or wake turbulence encounter, the assymmetrical acceleration limit applies.



G overshoots as a result of wingtip vortex or wake turbulence (jetwash) may not be of sufficient duration to trigger the MDP generated over g tone due to system processing rates. Pilots will use asymmetric g limits when evaluating a jetwash over g regardless of MDP g status.

HIGH SPEED DIVE RECOVERY

To recover from a high speed dive, simultaneously retard throttles to IDLE, open the speed brake, level the wings, and pull out with sufficient g for a safe recovery. See Figures 6-5, 6-6, and 6-7.

STANDARD DAY

GROSS WEIGHT 10,000 LB

DATE: 15 JANUARY 1965
DATA BASIS: FLIGHT TEST

1. BEGIN 1.5 G's MAX THRUST ENTRY.
2. ATTAIN 60° DIVE ANGLE.
3. REDUCE THRUST TO MIL AND BEGIN 4-G DIVE RECOVERY:
AT 26,400 FT FOR ENTRY AT 45,000 FT.
AT 27,800 FT FOR ENTRY AT 50,000 FT.
4. AND DIVE RECOVERY AT LEVEL FLIGHT ATTITUDE.

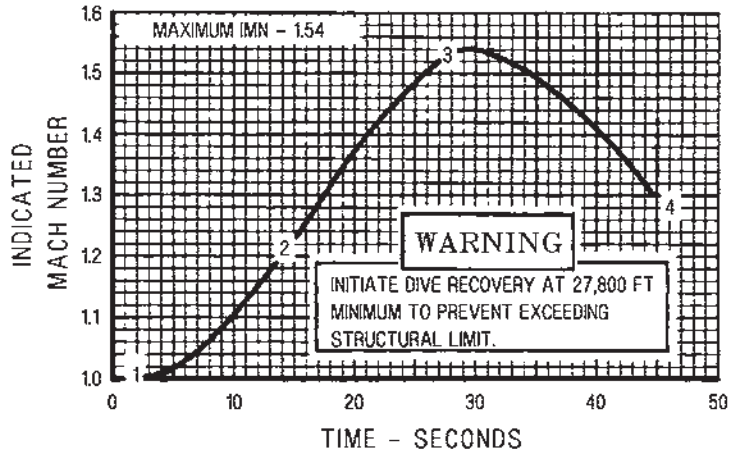
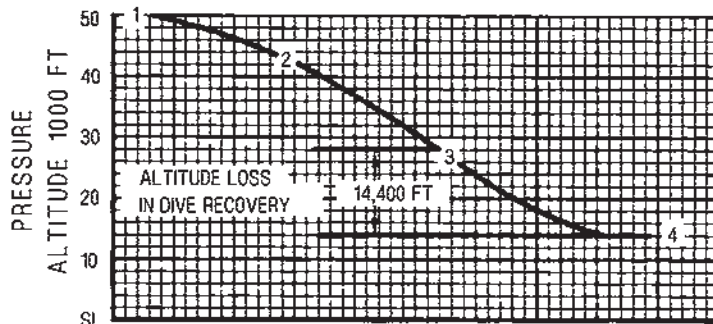
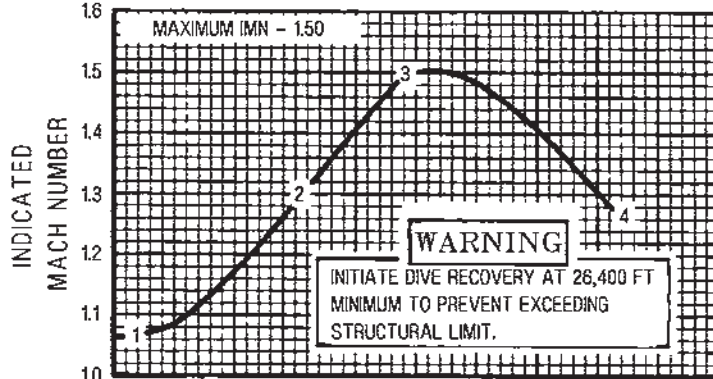
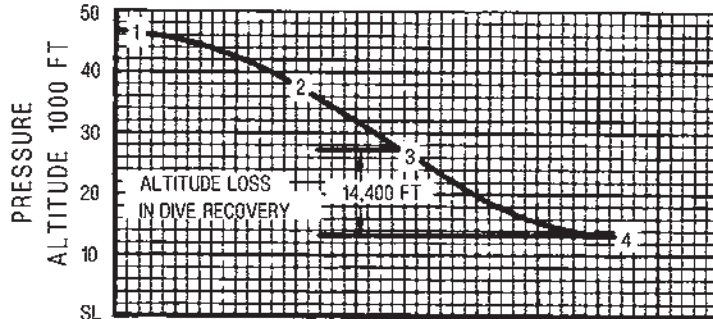

NOTE
ALTITUDE LOSS SHOWN INCLUDES A 4-SECOND TIME ALLOWNACE FOR LOAD FACTOR TO BUILD UP TO 4 G's

Figure 6-5. High Mach 60° Dive

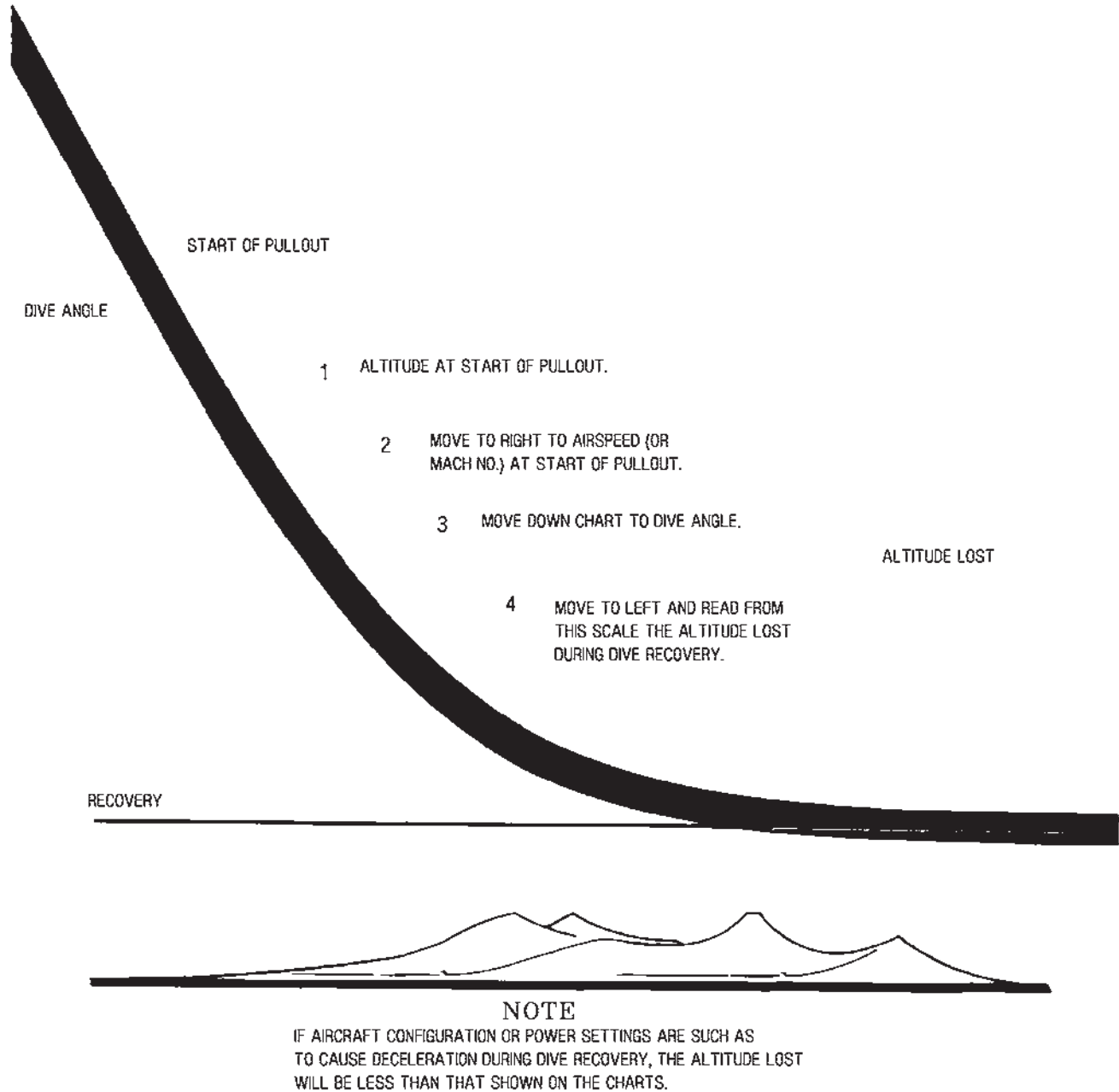

T38002-61-1-020

Figure 6-6. How to Read Dive Recovery Charts

CONSTANT
4.0 G
ACCELERATION

DATE: 15 JANUARY 1965
DATA BASIS: FLIGHT TEST

- SUBSONIC LIFT LIMIT IS DETERMINED BY BUFFET.
- SUPERSONIC LIFT LIMIT IS DETERMINED BY HORIZONTAL TAIL DEFLECTION LIMIT.

THE DASHED LIMITS (LIFT LIMITS) ON THE LEFT OF THE CHART SHOW THE AIRSPEED AT WHICH THE AIRCRAFT WILL ENTER AN ACCELERATED STALL AT THE G'S INDICATED.

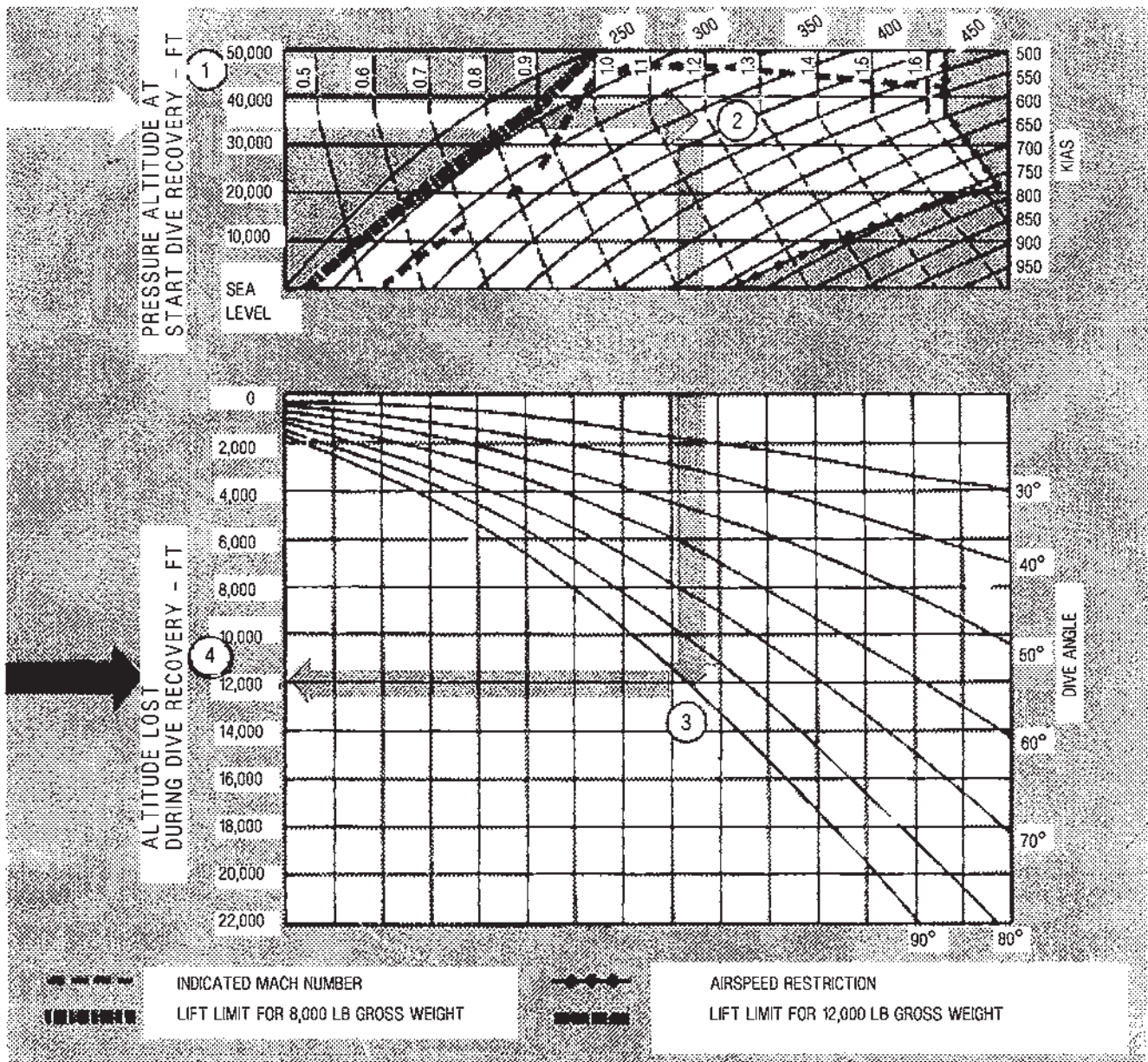

T38002-61-2-020

Figure 6-7. Altitude Lost During Dive Recovery (Sheet 1 of 3)

CONSTANT
6.0 G
 ACCELERATION

DATE: 15 JANUARY 1965
 DATA BASIS: FLIGHT TEST

- SUBSONIC LIFT LIMIT IS DETERMINED BY BUFFET.
- SUPERSONIC LIFT LIMIT IS DETERMINED BY HORIZONTAL TAIL DEFLECTION LIMIT.
- THE DASHED LIMITS (LIFT LIMITS) ON THE LEFT OF THE CHART SHOW THE AIRSPEED AT WHICH THE AIRCRAFT WILL ENTER AN ACCELERATED STALL AT THE G'S INDICATED.

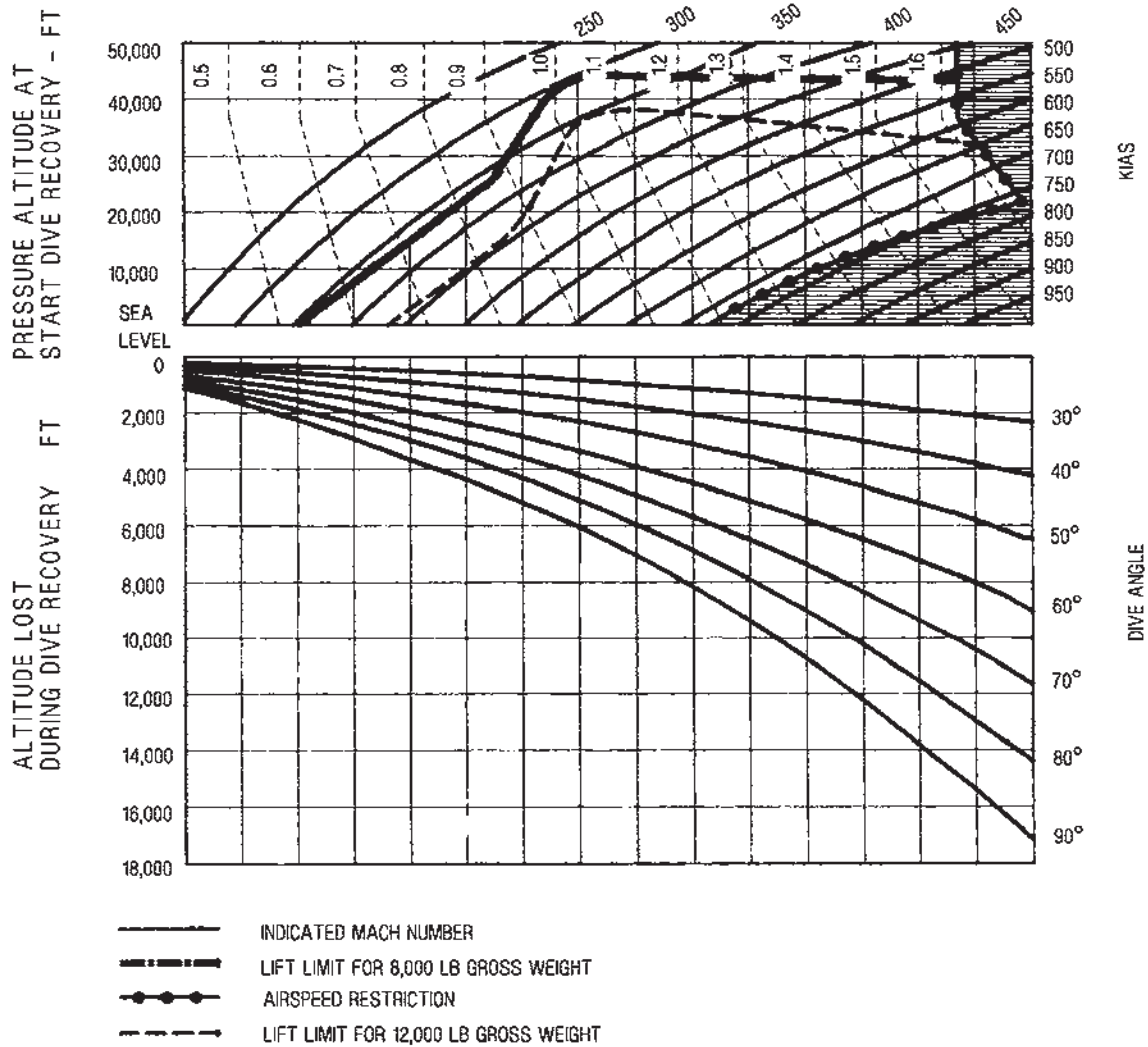

T38002-61-3-020

Figure 67-. Altitude Lost During Dive Recovery (Sheet 2)

CONSTANT
7.33 G
 ACCELERATION

DATE: 15 JANUARY 1965
 DATA BASIS: FLIGHT TEST

- SUBSONIC LIFT LIMIT IS DETERMINED BY BUFFET.
- SUPERSONIC LIFT LIMIT IS DETERMINED BY HORIZONTAL TAIL DEFLECTION LIMIT.
- THE DASHED LIMITS (LIFT LIMITS) ON THE LEFT OF THE CHART SHOW THE AIRSPEED AT WHICH THE AIRCRAFT WILL ENTER AN ACCELERATED STALL AT THE G'S INDICATED.

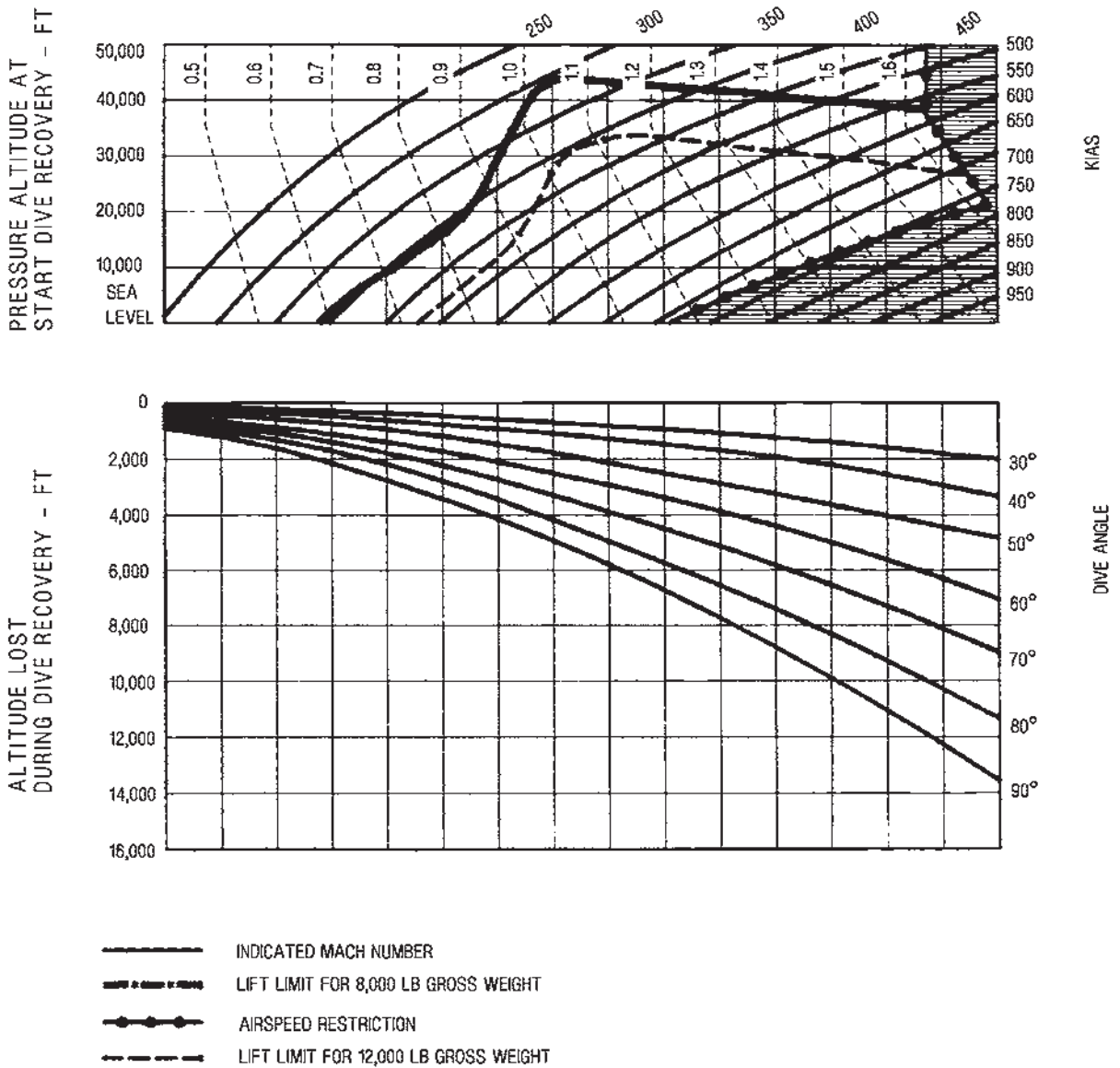

T38002-61-4-020

Figure 6-7. Altitude Lost During Dive Recovery (Sheet 3)

SECTION VII

ADVERSE WEATHER OPERATION

TABLE OF CONTENTS

	Page
Turbulence And Thunderstorms.....	7-1
Snow, Ice, Rain and Slush	7-1
Cold Weather Operation	7-3
Hot Weather/Desert Operation.....	7-4

This section provides for operation in adverse weather. Section II of this manual provides normal instrument flight procedures. These procedures differ from, or are in addition to, those contained in section II.

TURBULENCE AND THUNDERSTORMS



- Pilots should avoid intentional flight in thunderstorms.
- During flight near thunderstorms or in thin cirrus clouds, the UHF radio can become unstable and the MFD flight instruments, and EED fuel displays, distorted. These conditions can cause the aircraft to build up a static electrical charge. Static can overcome the UHF radio to the degree that transmissions to the aircraft are not received clearly. Transmissions from the aircraft are not affected. If UHF noise adversely affects reception, switch to the UPPER COMM ANTENNA, or use the UHF backup

control panel. MFD and EED displays can become temporarily distorted, with EED fuel quantity displays having been observed to vary by as much as 200 pounds. Fly by reference to standby instruments, which are not affected. MFD and EED displays return to normal when flight near thunderstorms or in thin cirrus is terminated.

The recommended penetration airspeed if turbulence and thunderstorms are experienced is 280 KCAS.

When forecast conditions include thunderstorms or high cirrus clouds, set the UHF backup control panel to an appropriate frequency for the planned flight route. Use the preset channels available via the UHF backup control panel. These channels can be programmed during preflight planning.

SNOW, ICE, RAIN AND SLUSH

BEFORE FLIGHT

PREFLIGHT INSPECTION

Remove all protective covers and duct plugs; check to see that all surfaces, ducts, struts, drains, canopy rails, and vents are free of snow, ice, and frost. Brush off light snow and frost. Remove ice and encrusted

snow either by a direct flow of air from a portable ground heater or by using de-icing fluid.



- All ice, snow and frost must be removed from the aircraft before flight is attempted. Takeoff distance and climbout performance can be adversely affected by ice and snow accumulations.

T.O. 1T-38C-1

The roughness and distribution of these accumulations can vary stall speeds and alter flight characteristics to a degree extremely hazardous to safe flight.

- Ensure water does not accumulate in control hinge areas or other critical areas where refreezing may cause damage or binding.



To avoid damage to aircraft surfaces, do not permit ice to be chipped or scraped away.

Check the fuel system vents on the vertical stabilizer for freedom from ice. Remove all dirt and ice from landing gear shock struts, actuating cylinder pistons, and limit switches. Wipe exposed parts of shock struts and pistons with a rag soaked in hydraulic fluid. Inspect aircraft carefully for fuel and hydraulic leaks caused by contraction of fitting or by shrinkage of packages. Inspect area behind aircraft to ensure water or snow will not be blown onto personnel and equipment during engine start.

TAXIING

Nosewheel steering effectiveness is reduced when taxiing on ice and hard packed snow. A combination of nosewheel steering and wheel braking should be used for directional control. The nosewheel will skid sideways easily, increasing the possibility of tire damage. Reduce taxi speeds and exercise caution at all times while operating on these surfaces. Increase the normal interval between aircraft both to ensure safe stopping distance and to prevent icing of the aircraft from melted snow and ice caused by jet blast of preceding aircraft. Minimize taxi time to conserve fuel and reduce the amount of ice fog generated by the engines. If bare spots exist through the snow, skidding onto them should be avoided. Check for sluggish instruments while taxiing.

INFLIGHT

ICING

Anti-icing equipment for the wings, empennage, and inlet ducts is not provided. The aircraft is provided with engine anti-ice, pitot heat, and canopy defog heat, which also provides windshield heat for adverse

weather operation. Icing conditions that may be encountered are trace, light, moderate, and severe. Moderate and severe icing, particularly, can cause rapid buildup of ice on the aircraft and greatly affect performance.



The aircraft should not be flown in icing conditions. If icing is inadvertently encountered, leave the area of icing conditions as soon as possible.

When icing conditions are unavoidable, place the pitot heat switch at PITOT HEAT and turn the canopy defog to full increase. The aircraft is not equipped with windshield anti-icing or rain removal equipment. Instrument approaches in heavy rain are possible, but forward visibility through the windshield may be marginal. Forward visibility in icing conditions is further reduced and may be completely obscured through the windshield.

ICE INGESTION

Engine damage may occur if as little as 0.25 inch of ice accumulates on engine inlet duct lips. Ingestion of accumulated ice into an engine may be evidenced by shaking or noise in the engine and may result in damage to inlet guide vanes and first-stage compressor blades. Engine instrument indications may remain normal, even though ice ingestion has damaged engines.



- After ice ingestion, operate the affected engine at the lowest possible RPM necessary to make a safe landing and avoid abrupt or rapid throttle movements.
- If flight in icing conditions results in ice accumulations on the aircraft, enter this in AFTO Form 781, since the engines must be inspected for ice ingestion damage when this occurs.

ENGINE ICING

Engine inlet duct and/or guide vane icing may occur when the ambient temperature is at or slightly above freezing and either the humidity is high or when

operating in visible moisture. Under these conditions, and when icing conditions are unavoidable, immediately place the engine anti-ice switch to MAN ON, ensuring continuous anti-icing action.

NOTE

To ensure effective anti-icing, maintain a minimum of 80 % RPM when the engine anti-icing system is turned ON.

RAIN



Flight in moderate precipitation may damage the nose cone or vertical stabilizer. Nose cone damage may result in inflight engine FOD. If flight in moderate precipitation is unavoidable, slow to the minimum practical airspeed to negate or lessen damage.

COLD WEATHER OPERATION

Most cold weather operating difficulties are encountered on the ground. Use the following instructions in conjunction with the normal procedures given in section II when cold weather aircraft operation is necessary.

BEFORE FLIGHT

ENGINE START

Use external power for starting to conserve the battery. No preheat or special starting procedures are required; however, at temperatures below -30°F (-34°C), allow the engines to idle 2 minutes before accelerating. Turn on cockpit heat and canopy defog, as required, immediately after engine start. Check flight controls, speed brake, and aileron trim for proper operation. Cycle flight controls four to six times. Check hydraulic pressure and control reaction, and operation of all instruments.

ENGINE OIL PRESSURE

Oil pressure indications above 55 PSI will be observed after engine start. As the oil warms up, pressure

LANDING

Use landing techniques given in section II. When landing on runways that have patches of dry surface, avoid locking the wheels. If the aircraft starts to skid, release brakes until recovery from skid is accomplished.

should reduce to within operating limits. To reduce time for oil pressure to return to normal, the engine may be operated above idle up to military power until oil pressure is within limits. If oil pressure does not return to operating limits, shut down engine and determine cause.

ENGINE IDLE RPM

Low idle RPM can be expected after engine start when the engines are cold and the ground ambient temperature is below -16°F (-26°C). Monitor EGT and increase RPM as necessary to cut in the AC generators. If RPM will not increase when throttle is advanced, shut down engine and determine cause. Idle RPM should be within operating limits after the engine has warmed up and the oil pressure has decreased to normal operating range.

HOT WEATHER/DESERT OPERATION

Operation of the aircraft in hot weather and in the desert requires that precautions be taken to protect the aircraft from damage caused by high temperatures, dust, and sand. Care must be taken to prevent the entrance of sand into aircraft parts and systems such as the engines, fuel system, pitot-static system, etc. All filters should be checked more frequently than under normal conditions. Plastic and rubber segments of the aircraft should be protected both from high temperatures and blowing sand. Canopy covers should be left off to prevent sand from accumulating between the cover and the canopy and acting as an abrasive on the plastic canopy. With a canopy closed, cockpit damage may result when ambient temperature is in excess of 110°F. Desert and hot weather operation require that, in addition to normal procedures, the following precautions be observed.

TAKEOFF

1. Monitor pitch attitude closely to ensure a positive rate of climb during gear and flap retraction and to prevent an excessive angle of attack.

2. Be alert for gusts and wind shifts near the ground.

APPROACH AND LANDING

1. Monitor airspeed closely to ensure recommended approach and touchdown airspeeds are maintained; high ambient temperatures cause speed relative to the ground to be higher than normal.
2. Anticipate a long landing roll due to higher ground speed at touchdown.
3. Use effective aerodynamic braking and all available runway for stopping the aircraft without overheating the wheel brakes.

FOLDOUT ILLUSTRATIONS

TABLE OF CONTENTS

Front Cockpit	FP-3	Avionics Functional Overview	FP-13
Rear Cockpit	FP-7	F-16 HUD	FP-15
UFCP Controls and Displays	FP-11	MIL-STD HUD	FP-17
		Menu Display Selection	FP-19

MAIN INSTRUMENT
PANEL

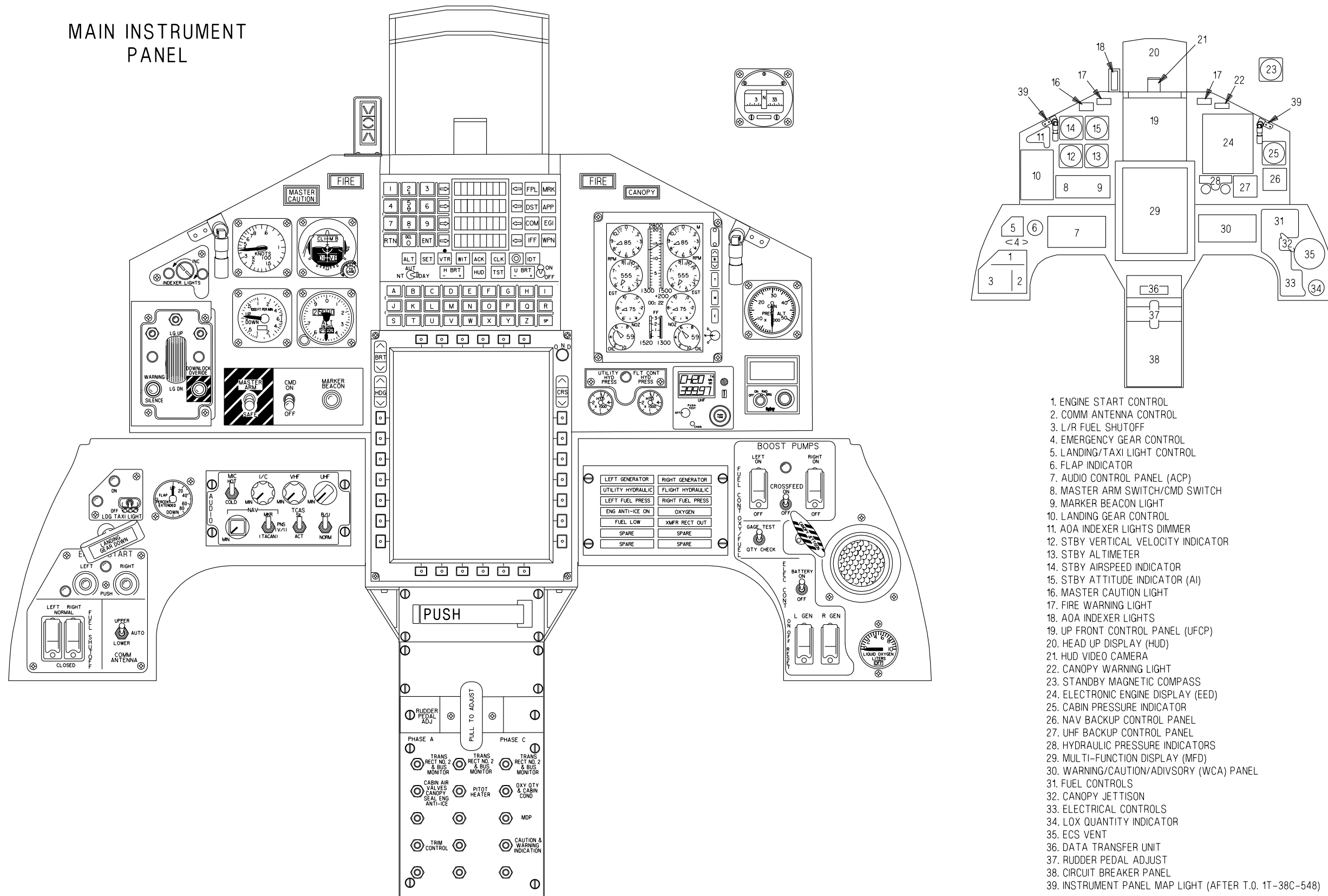

1. ENGINE START CONTROL
2. COMM ANTENNA CONTROL
3. L/R FUEL SHUTOFF
4. EMERGENCY GEAR CONTROL
5. LANDING/TAXI LIGHT CONTROL
6. FLAP INDICATOR
7. AUDIO CONTROL PANEL (ACP)
8. MASTER ARM SWITCH/CMD SWITCH
9. MARKER BEACON LIGHT
10. LANDING GEAR CONTROL
11. AOA INDEXER LIGHTS DIMMER
12. STBY VERTICAL VELOCITY INDICATOR
13. STBY ALTIMETER
14. STBY AIRSPEED INDICATOR
15. STBY ATTITUDE INDICATOR (AI)
16. MASTER CAUTION LIGHT
17. FIRE WARNING LIGHT
18. AOA INDEXER LIGHTS
19. UP FRONT CONTROL PANEL (UFCP)
20. HEAD UP DISPLAY (HUD)
21. HUD VIDEO CAMERA
22. CANOPY WARNING LIGHT
23. STANDBY MAGNETIC COMPASS
24. ELECTRONIC ENGINE DISPLAY (EED)
25. CABIN PRESSURE INDICATOR
26. NAV BACKUP CONTROL PANEL
27. UHF BACKUP CONTROL PANEL
28. HYDRAULIC PRESSURE INDICATORS
29. MULTI-FUNCTION DISPLAY (MFD)
30. WARNING/CAUTION/ADVISORY (WCA) PANEL
31. FUEL CONTROLS
32. CANOPY JETTISON
33. ELECTRICAL CONTROLS
34. LOX QUANTITY INDICATOR
35. ECS VENT
36. DATA TRANSFER UNIT
37. RUDDER PEDAL ADJUST
38. CIRCUIT BREAKER PANEL
39. INSTRUMENT PANEL MAP LIGHT (AFTER T.O. 1T-38C-548)

T38002-53-2-020

Figure FO-1. Front Cockpit (Sheet 1 of 2)

LEFT
CONSOLE

1. TACAN BACKUP CONTROLLER
2. THROTTLE QUADRANT
3. TAKEOFF TRIM PANEL
4. YSAS CONTROL PANEL
5. AVIONICS ACTIVATION PANEL
6. ANTENUATE/ANTI-G PANEL
7. CIRCUIT BREAKER PANEL

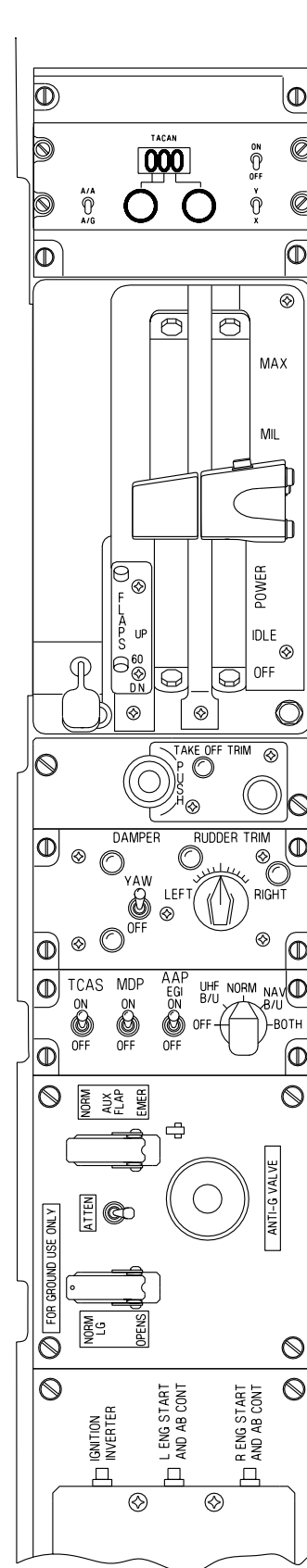
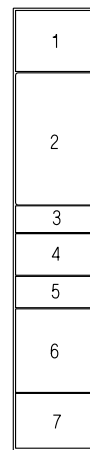

RIGHT
CONSOLE

8. OXYGEN REGULATOR PANEL
9. ECS PANEL
10. LIGHTING CONTROL PANEL
11. MAP CASE
12. BLANK PANEL
13. BLANK PANEL
14. UTILITY LIGHT

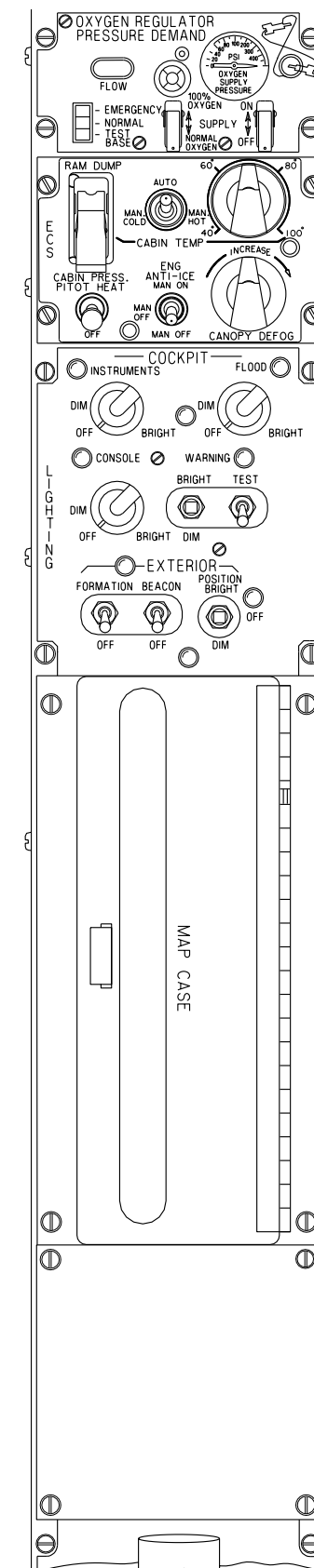
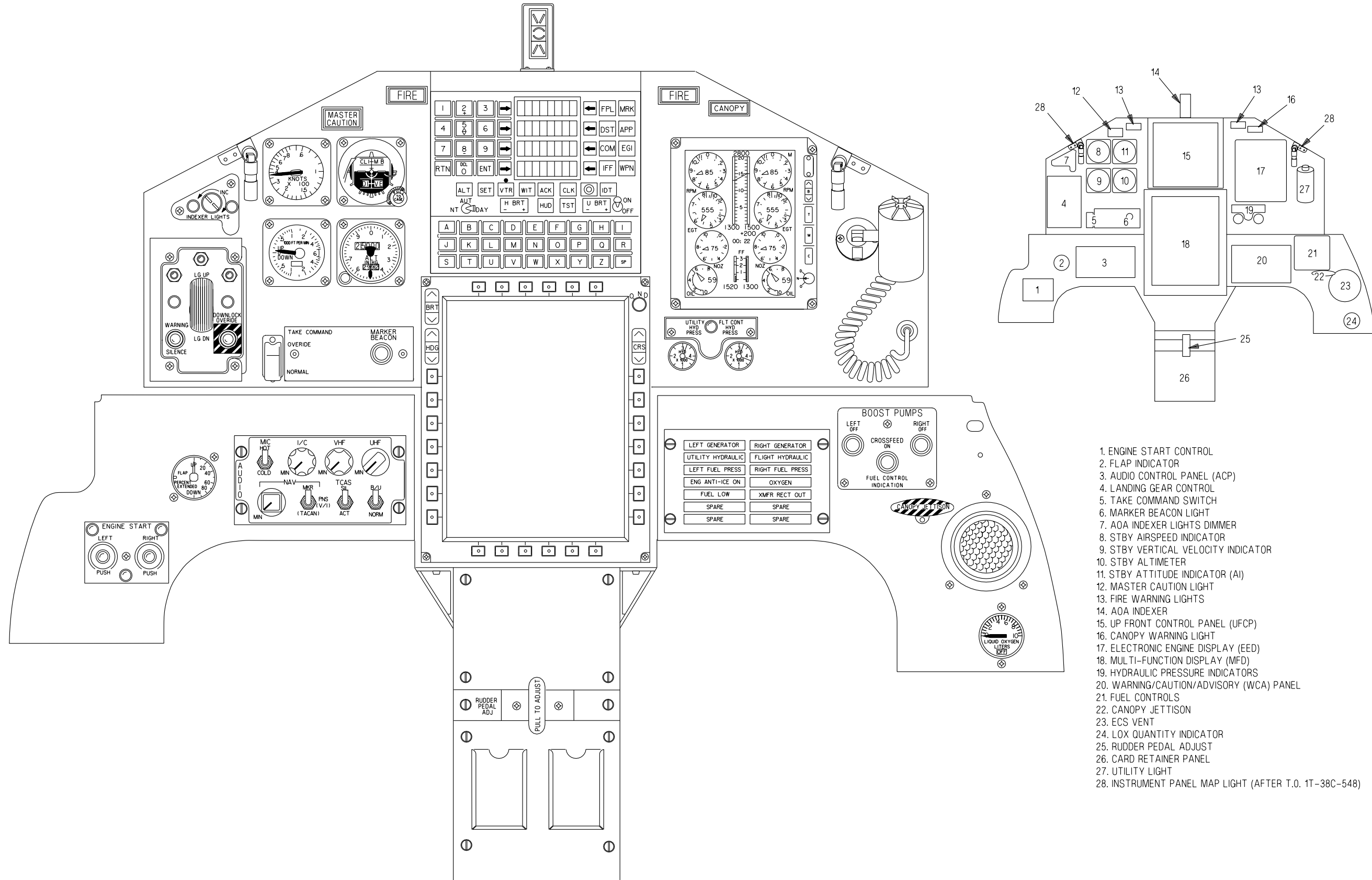

Figure FO-1. Front Cockpit (Sheet 2)

FP-5/(FP-6 blank)



T38002-54-2-020

Figure FO-2. Rear Cockpit (Sheet 1 of 2)

LEFT CONSOLE

1. STOWAGE BOX
2. THROTTLE QUADRANT
3. TAKE-OFF TRIM PANEL
4. MISCELLANEOUS SWITCH PANEL
5. ANTI-G PANEL
6. CIRCUIT BREAKER PANEL

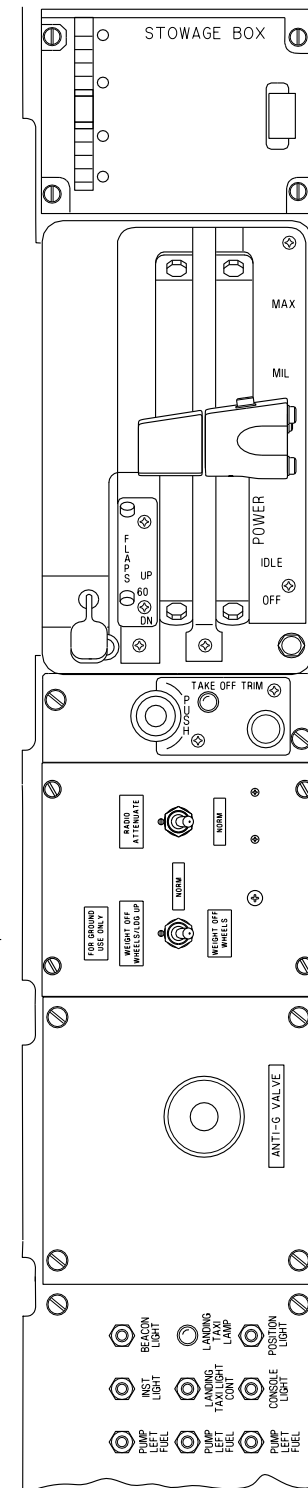
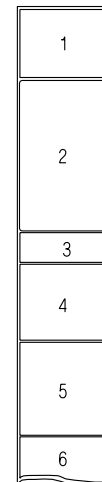

RIGHT CONSOLE

7. OXYGEN REGULATOR PANEL
8. BLANK PANEL
9. LIGHTING CONTROL PANEL
10. VIDEO TAPE RECORDER
11. MAP CASE
12. CIRCUIT BREAKER PANEL

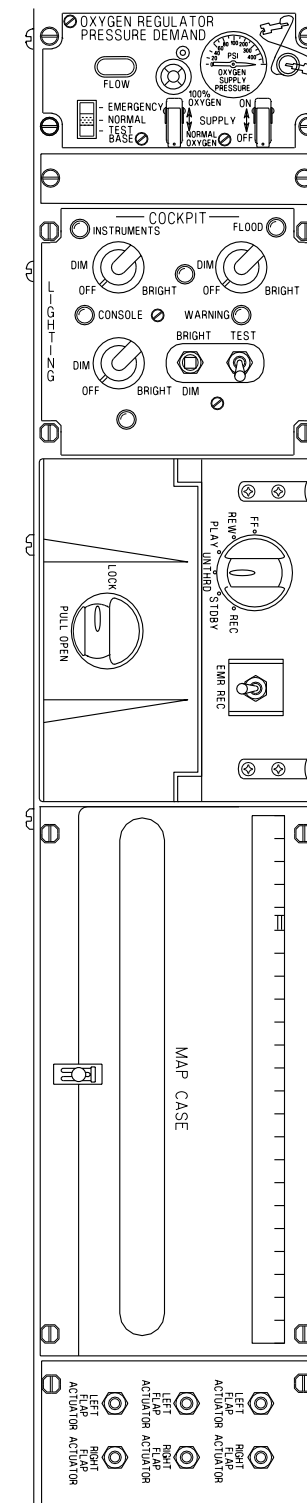
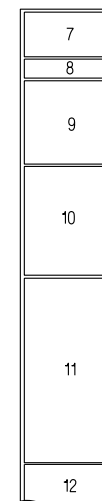

T38002-54-1-020

Figure FO-2. Rear Cockpit (Sheet 2)

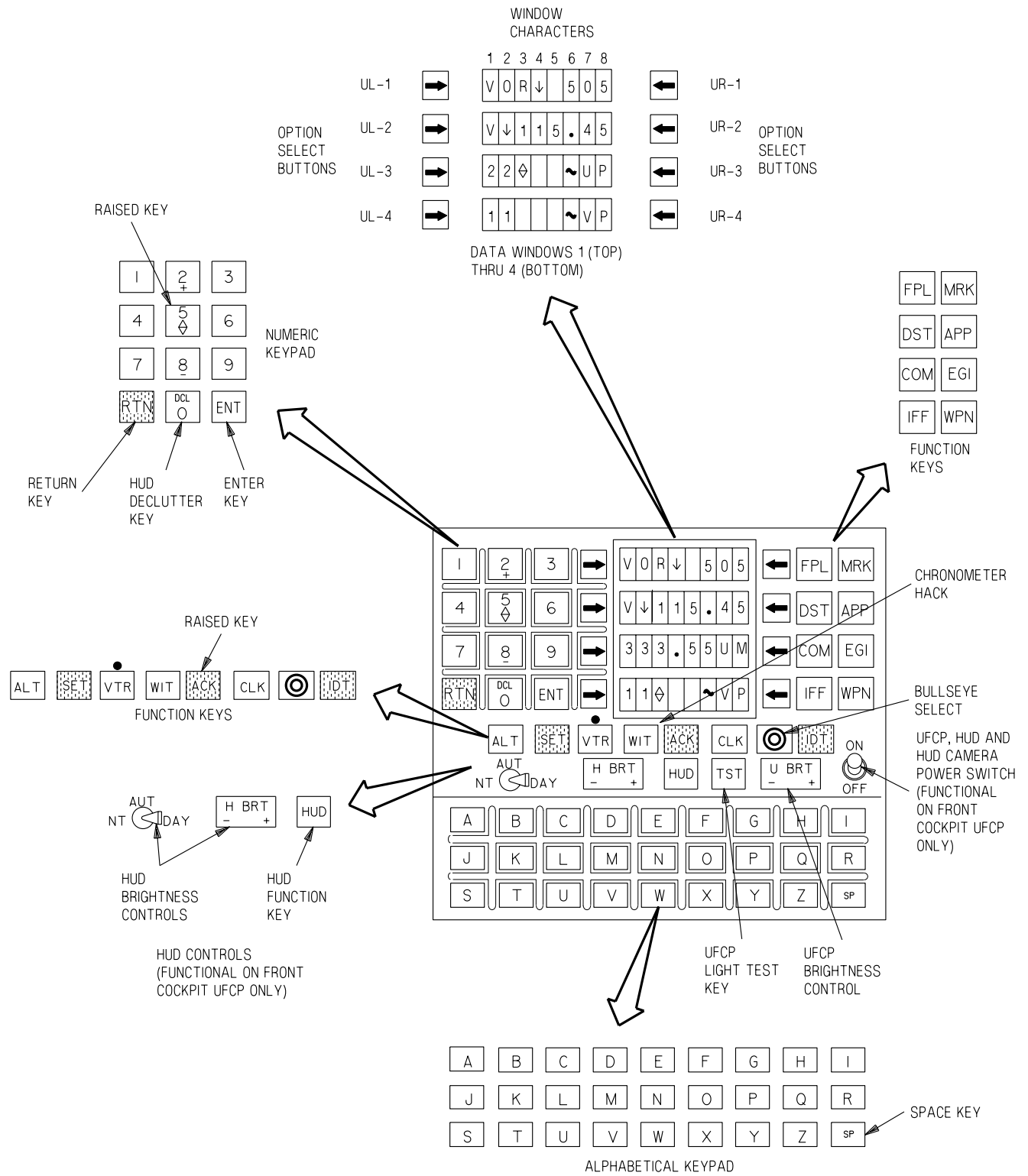

T38002-43-1-020

Figure FO-3. UFCP Controls and Displays

FP-11/(FP-12 blank)

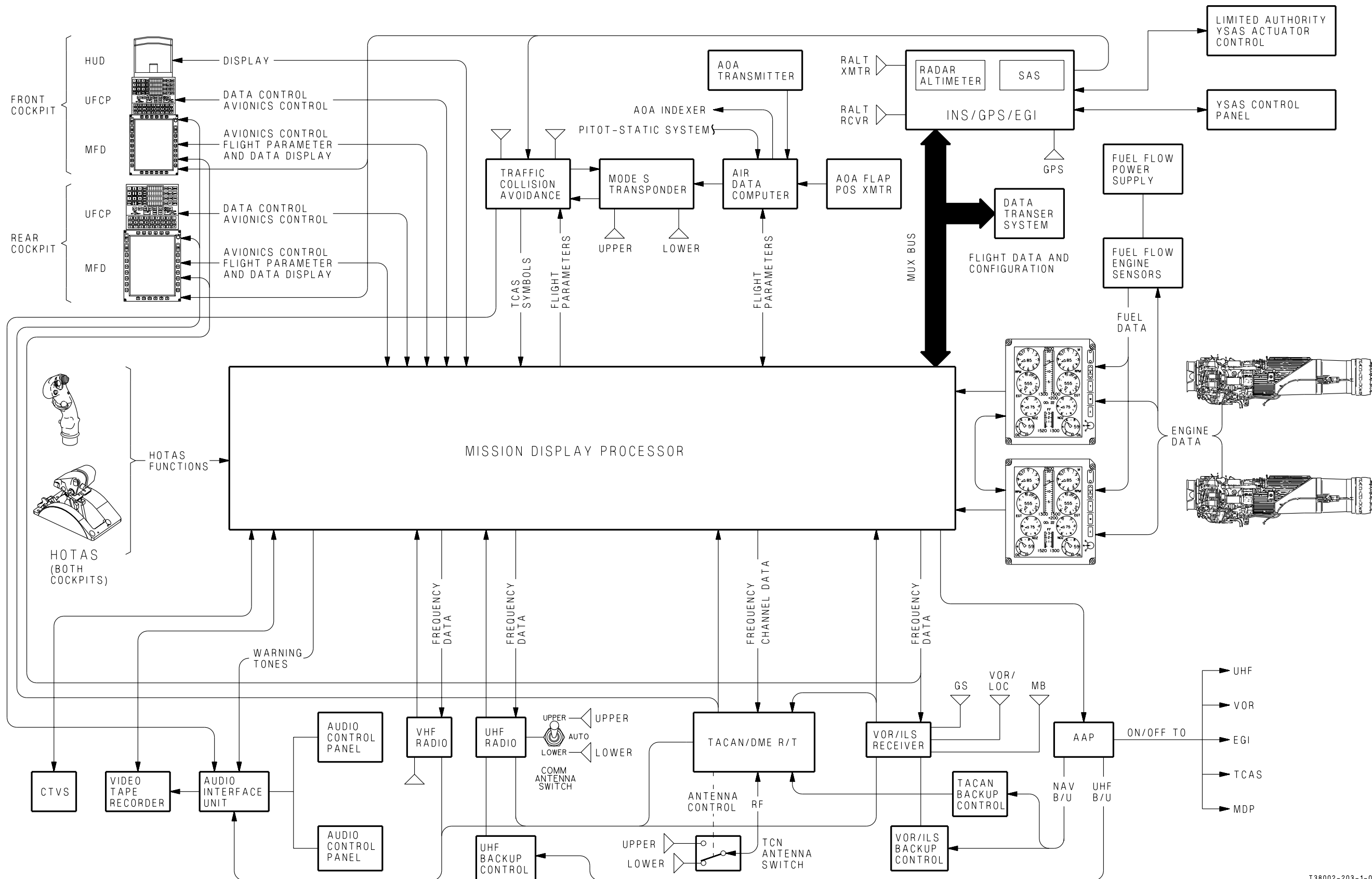

T38002-203-1-021

Figure FO-4. Avionics Functional Overview

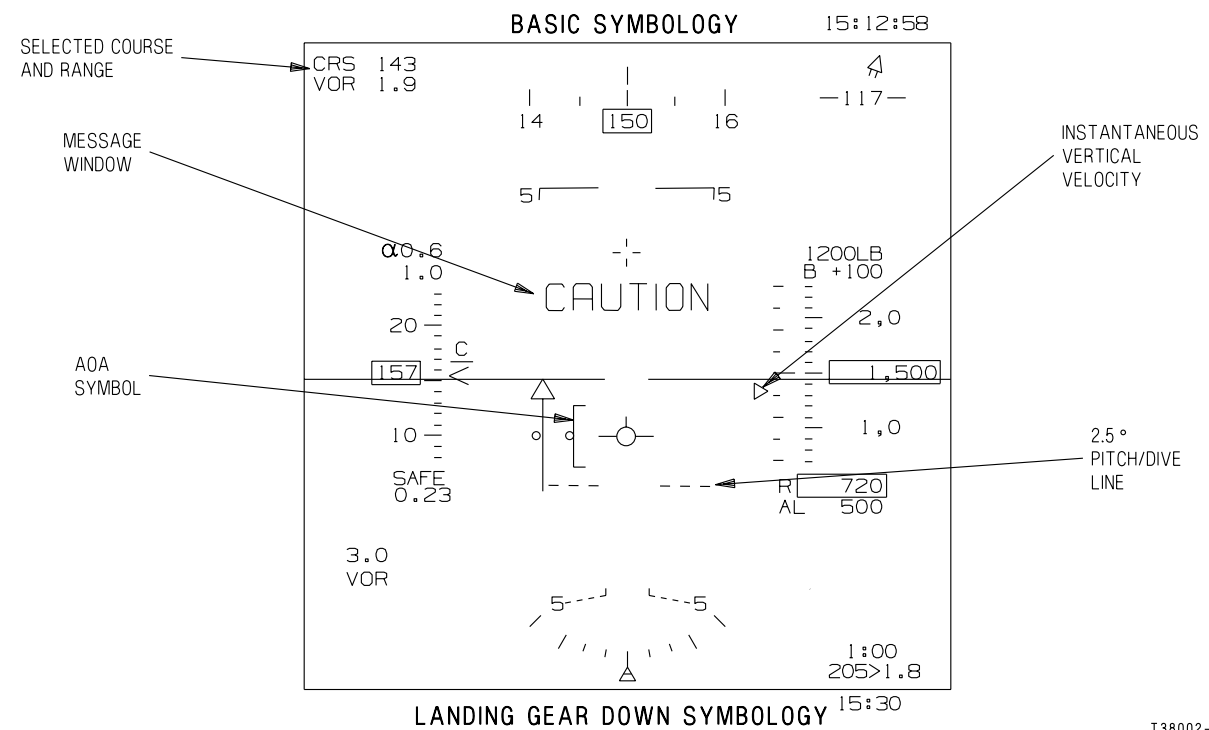
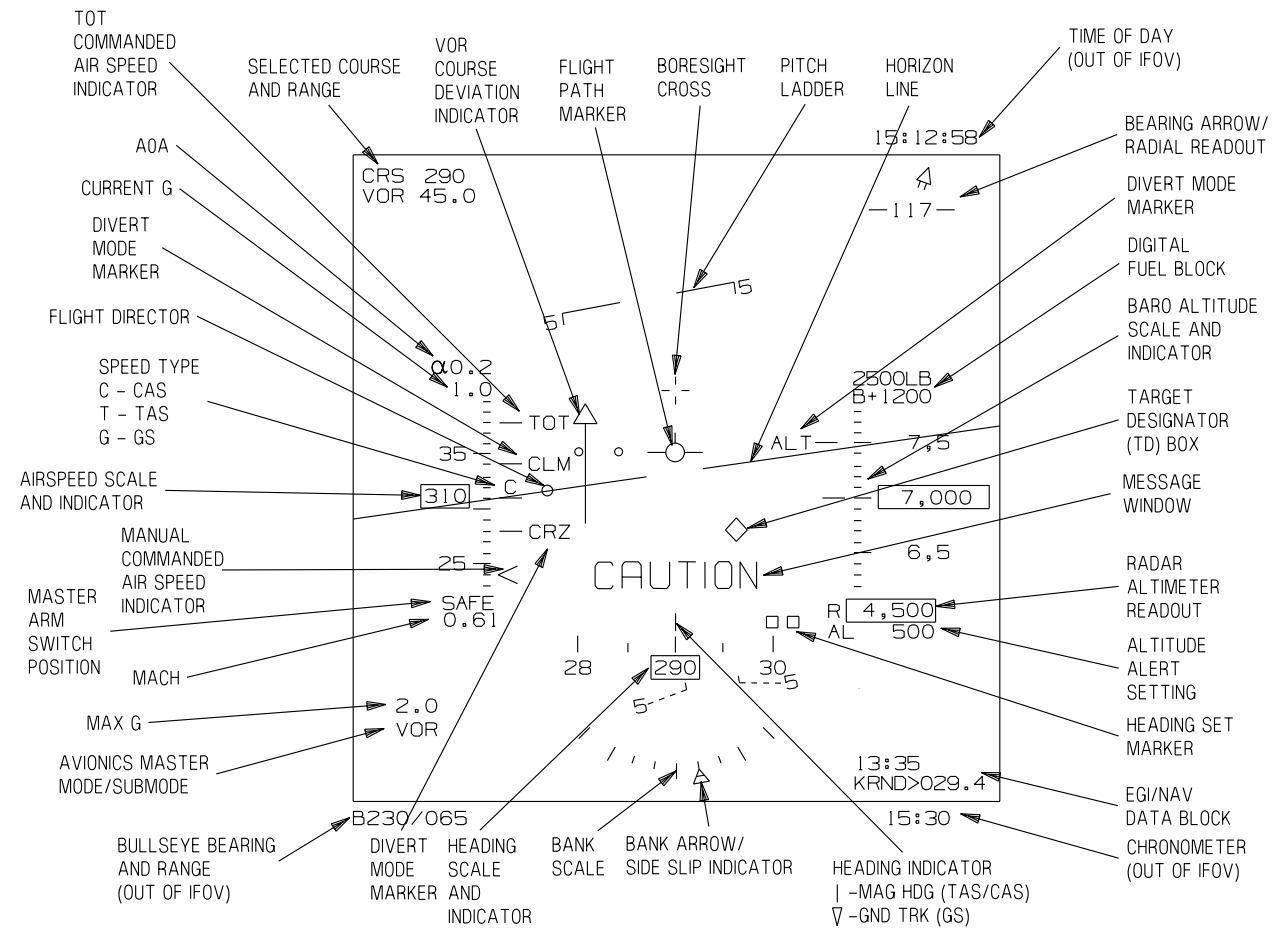

T38002-51-1-020

Figure FO-5. F-16 HUD

FP-15/(FP-16 blank)

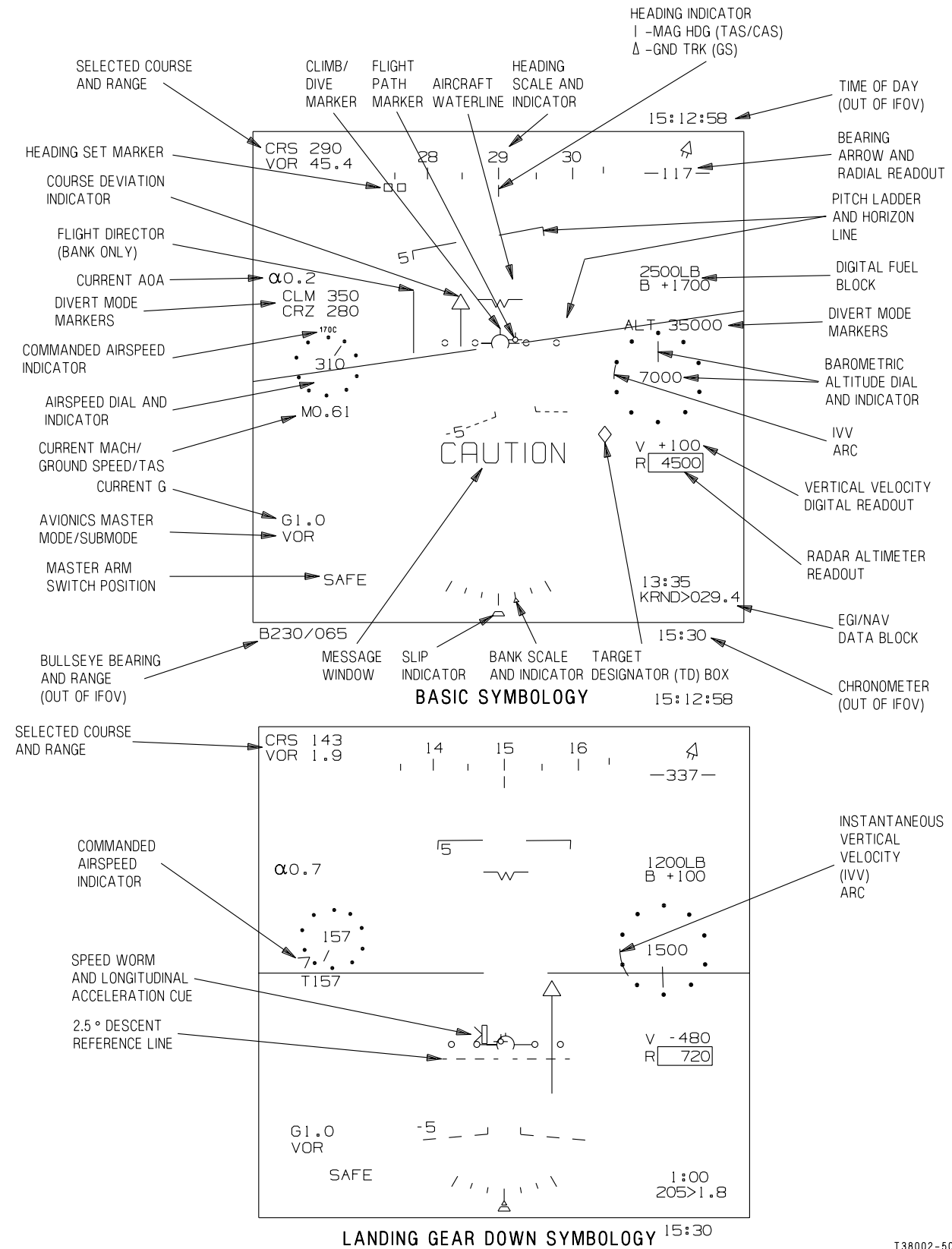

T38002-50-1-020

Figure FO-6. MIL-STD HUD

FP-17/(FP-18 blank)

DEST, FPL, ICAO OPTIONS, TRAINING ZONES, NO-FLY ZONES, NEAREST AIRPORT

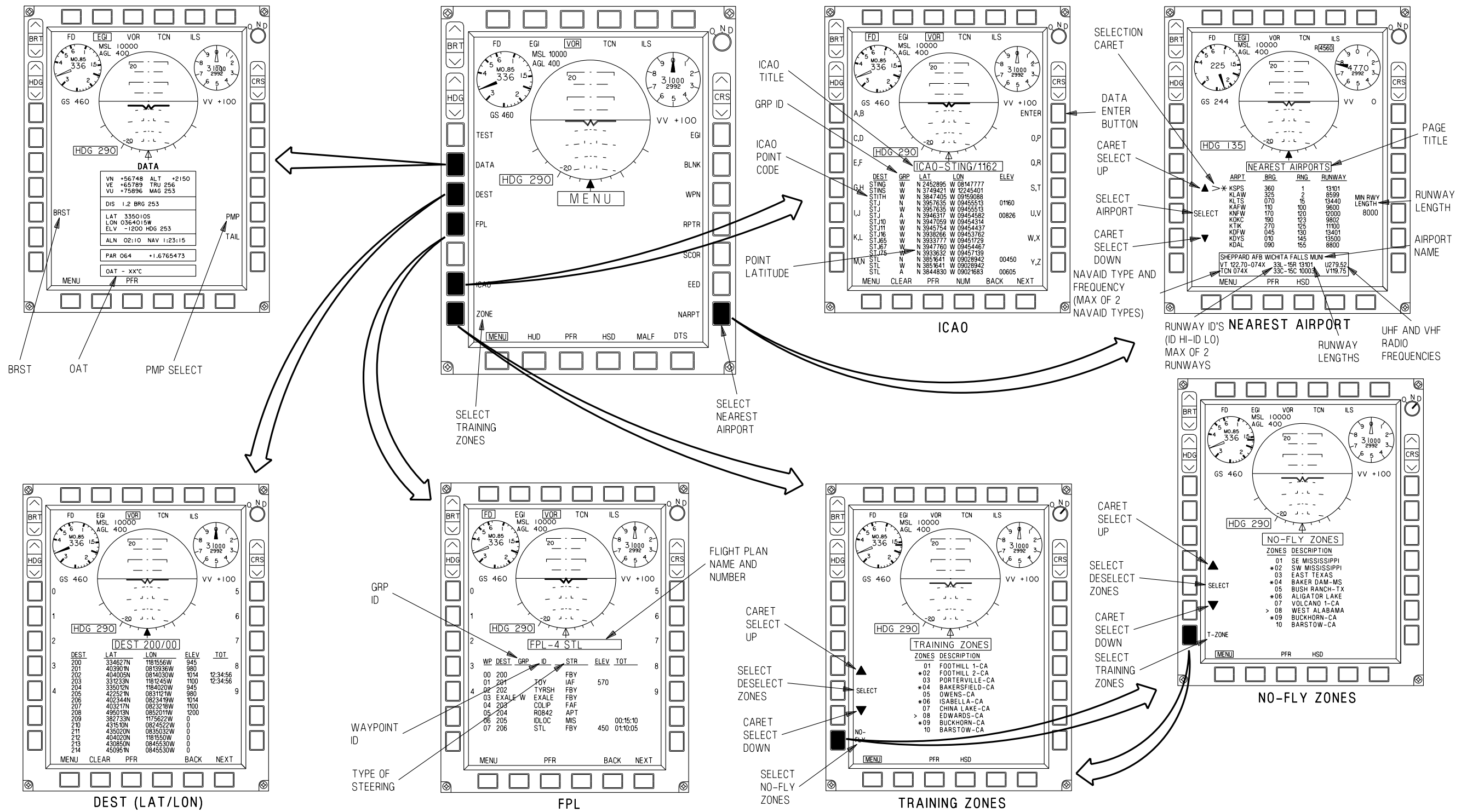

Figure FO-7. Menu Display Selection (Sheet 1 of 4)

T38002-68-1-020

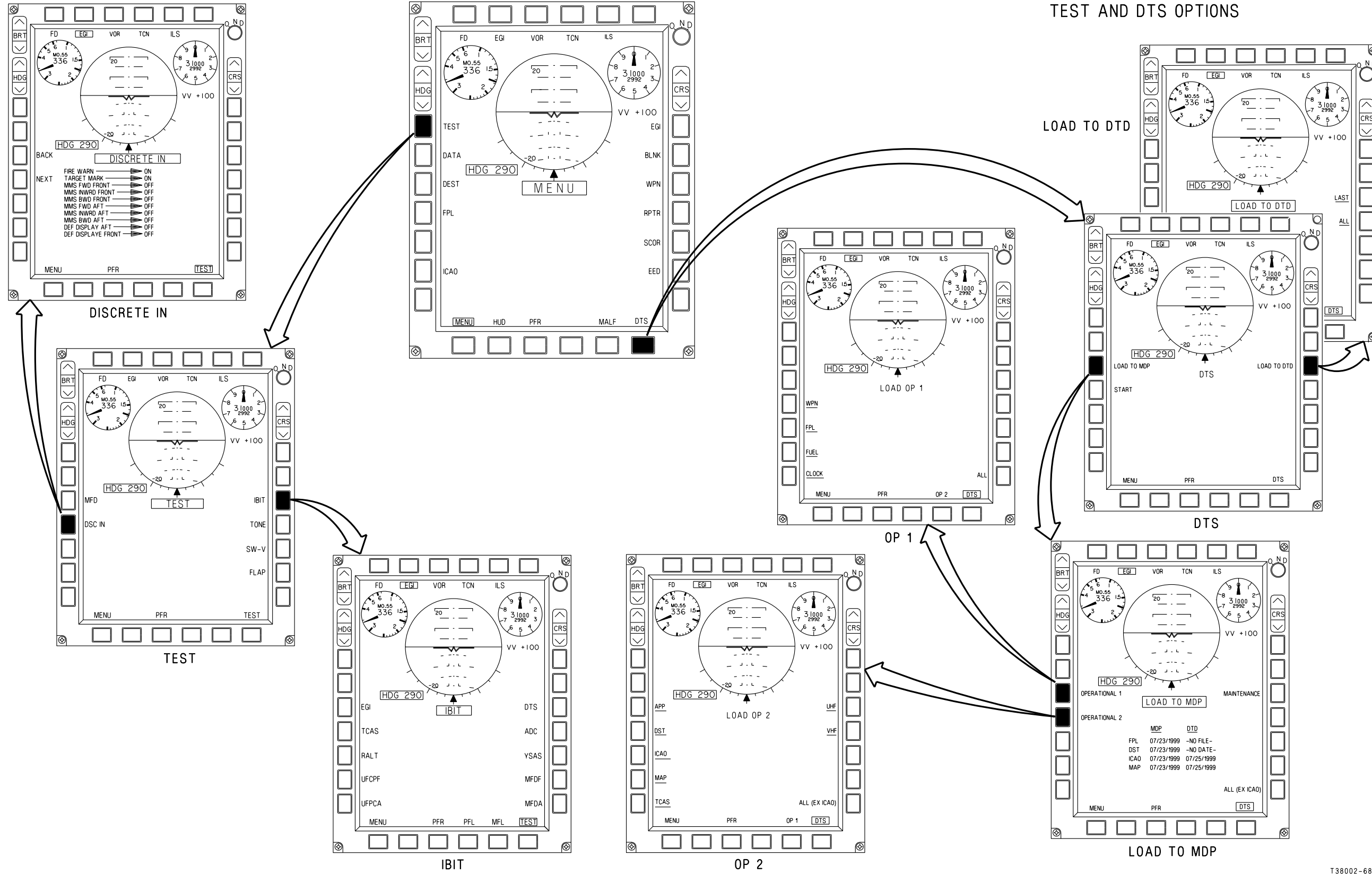

Figure FO-7. Menu Display Selection (Sheet2)

T38002-68-2-020

HUD, PFR/HSD, MALF OPTIONS

NOTE
MB-3 TOGGLES BETWEEN PFR AND HSD DISPLAYS. DEFAULTS TO PFR AT AIRCRAFT POWER UP.

NOTE
FAILURES ARE FOR DISPLAY PURPOSES ONLY AND DO NOT DEPICT A PARTICULAR FAILURE CONFIGURATION

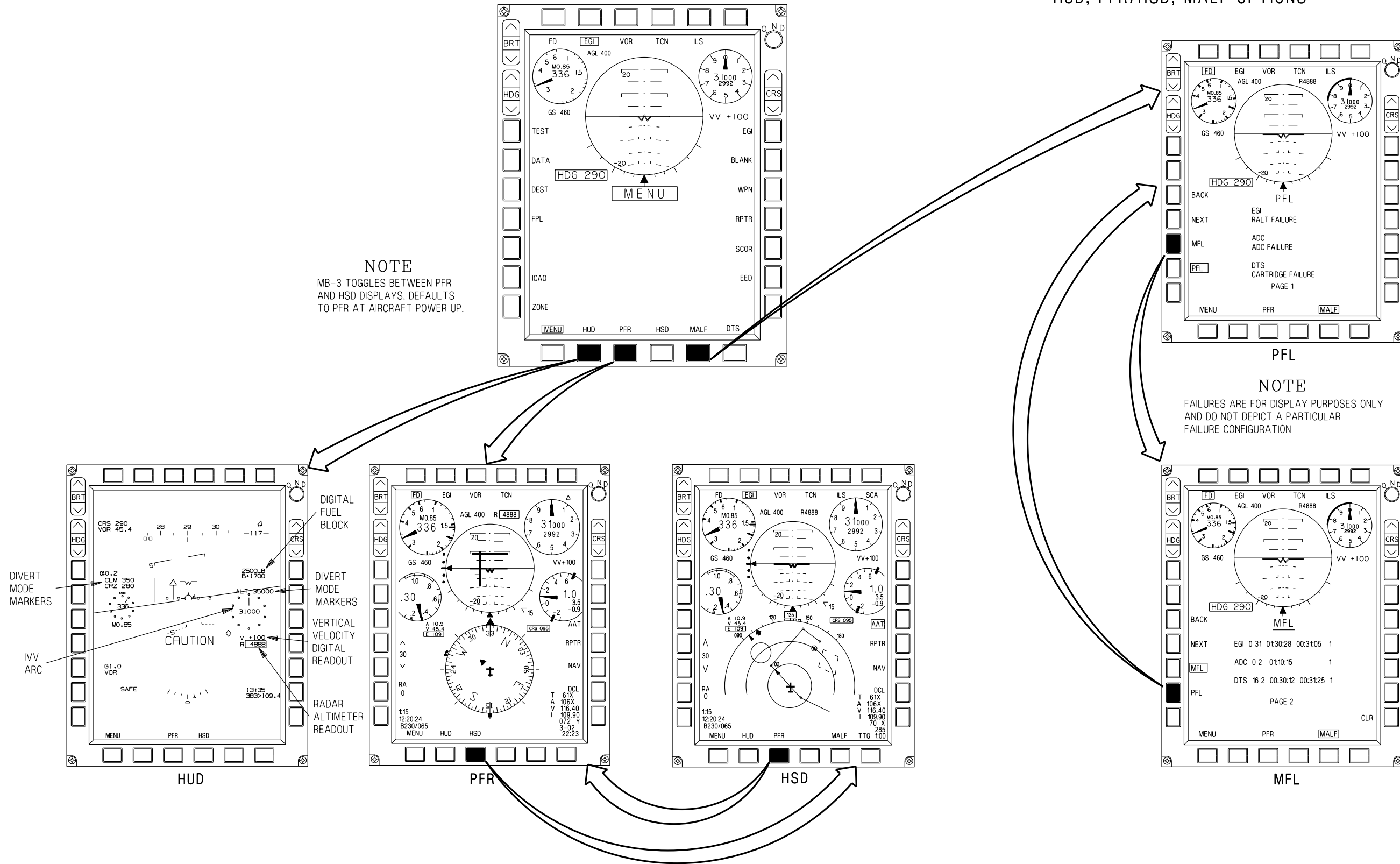
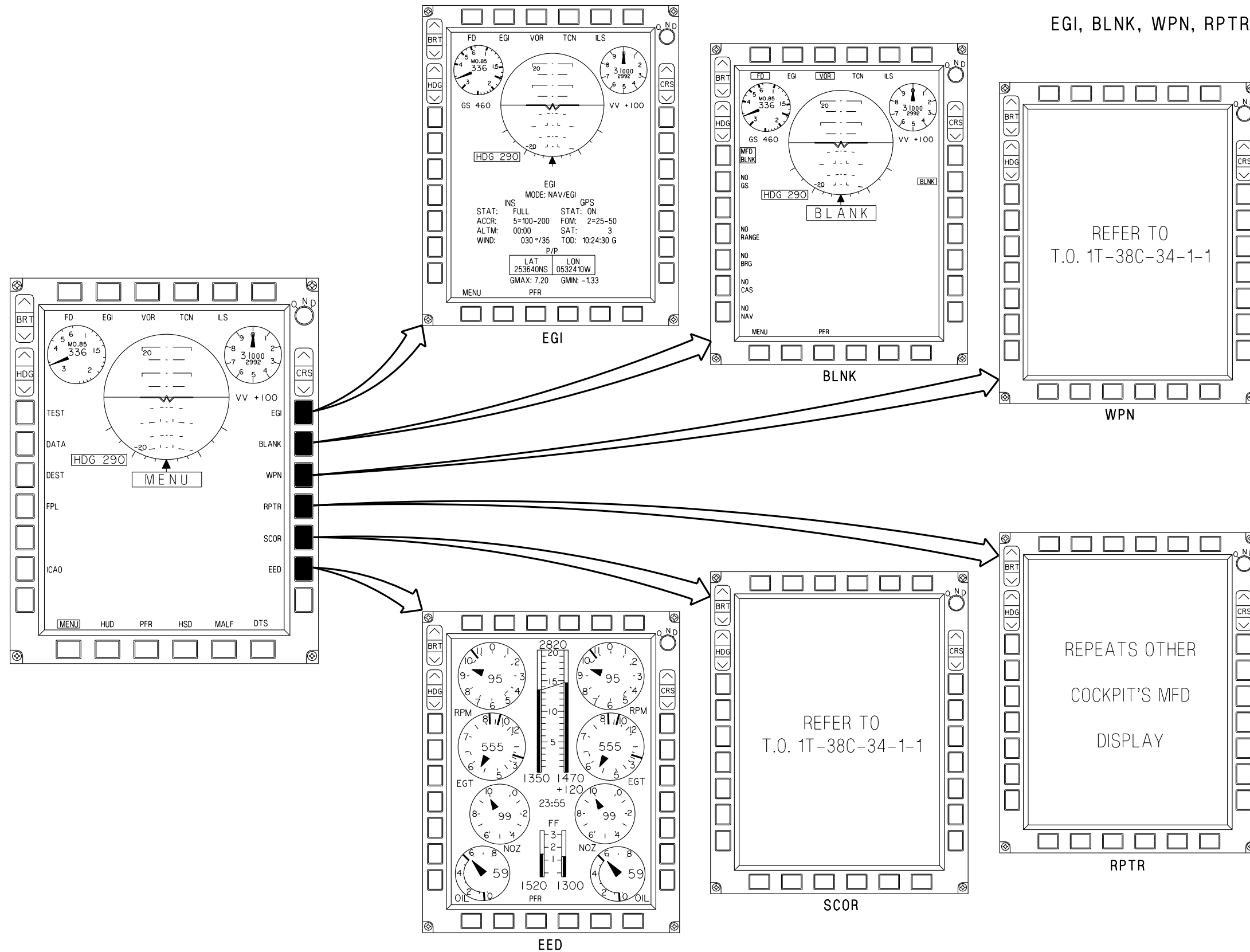

Figure FO-7. Menu Display Selection (Sheet 3)

T38002-68-3-020



EGI, BLNK, WPN, RPTR, SCOR, EED OPTIONS

Figure FO-7. Menu Display Selection (Sheet 4)

FP-25/(FP-26 blank)

GLOSSARY

A

A/A - Air To Air
 A/C - Aircraft
 A/G - Air To Ground
 AAP - Avionics Activation Panel
 ABC - Automatic Brightness Control
 ABV - Above
 AC - Alternating Current
 ACCR - Accuracy
 ACMI - Air Combat Maneuvering Instrumentation
 ACP - Audio Control Panel
 ADU - Automatic deployment unit
 AGL - Above Ground Level
 ARINC - Aeronautical Radio Incorporated
 AIU - Audio Interfacing Unit
 ALFA - Alphabetic
 ALN - Alignment/Align
 ALT - Altitude
 AOA - Angle of Attack
 AP - Approach
 APP - Approach
 ATC - Air Traffic Control
 ATT - Attenuation
 ATT - Attitude
 AUT - Auto
 AUP - Avionics Upgrade Program

Aural Tones - Low - 250 Hz, Medium - 500 to 900 Hz,
 High - 1600 Hz

B

BARO - Barometric
 BC (MFD) or BCRS - Back course
 BFL - Bomb Fall Line
 BGO - Bingo
 BIA - Baro-Inertial Altitude
 BIT - Built-In Test
 BLNK - Blank
 BLW - Below
 BRG - Bearing
 BRT - Bright
 BRST - Boresight
 BSL - Below Sea Level
 BU - Back-Up
 Bullseye - Any defined destination or ICAO point
 BWRD - Backward

C

C - Centigrade
 CAL - Coarse Alignment
 CAS - Calibrated Air Speed
 CCIP - Continuously Computed Intercept Point
 CCRP - Continuously Computed Release Point
 CCTL - Continuously Computed Tracer Line
 CDI - Course Deviation Indicator
 CDM - Climb Dive Marker

T.O. 1T-38C-1

CFOV - Center Field Of View

CG - Center of Gravity

CH - Channel

CHAN - Channel

CLK - Clock

CLM - Climb Airspeed

CLR - Clear

CMB - Combination

CMD - Counter Measures Dispenser

COM - Communication

COMM - Communication

CRN - Chronometer

CRS - Course

CRZ - Cruise Airspeed

CSW - Course Select Window

CTFOV - Center Total Field Of View

CTVS - Color TV Sensor System (HUD Camera)

D

DC - Direct Current

DCL - Declutter

DCLT - Declutter

DCO - Drift Cut Out

DDS - Default Display Switch

DEL - Delete

DEST - Destination

DG - Directional Gyro

DH - Decision Height

DME - Distance Measuring Equipment

DRF - Drift Free

DS - Destination

DST - Destination

DTC - Data Transfer Cartridge

DTD - Data Transfer Drive

DTS - Data Transfer System

E

EADI - Electronic Attitude Director Indicator

EED - Electronic Engine Display

EGI - Embedded GPS/INS

EGT - Exhaust Gas Temperature

EHSI - Electronic Horizontal Situation Indicator

ELV - Elevation

EMER - Emergency

EMR (TCAS Display) - Emergency

EO - Emergency Oxygen Handle

ENT - Enter

F

FAF - Final Approach Fix

FD - Flight Director

FF - Fuel Flow

FIP - Final Interception Point

FL - Flight Level

FLT - Flight

FNL - Final

FOM - Figure Of Merit

FPL - Flight Plan

FPM - Flight Path Marker

Glossary 2

fpm - feet per minute

FQ - Fuel Quantity

FRQ - Frequency

Ft - Feet

FWD - Forward

G

G/S - Glideslope

GC - Gyro Compass

GEO - Geographic

GEM - Graphics Engine Module

GHL - Ghost Horizon Line

GMT - Greenwich Mean Time

GPS - Global Positioning System

GRD - Guard

GRP ID - Group Identification

GS - Ground Speed

H

HDG - Heading

HLD - Hold

HM - Home

HOM - Home

HOTAS - Hands On Throttle And Stick

HSD - Horizontal Situation Display

HUD - Head Up Display

I

I/C - Intercom

IBIT - Initiated Built-In Test

ICAO - International Civil Aviation Organization

ICP - Illumination Control Panel

IFA - In Flight Alignment

ICP - Illumination Control Panel

ID - Identification

IFOV - Instantaneous Field-Of-View

IFR - Instrument Flight Rules

ILS - Instrument Landing System

IMN - Indicated Mach Number

INS - Inertial Navigation System

INSTR - Instrument

INWRD - Inward

ISS - Interseat Sequencing System

IVV - Instantaneous Vertical Velocity

J

JMPS - Joint Mission Planning System

K

KHz - Kilohertz

KIAS - Knots Indicated Airspeed

Kt - Knots

L

LAC - Longitudinal Acceleration Cue

LAT - Latitude

LCD - Liquid Crystal Display

LCOS - Lead Computing Optical Sight

LED - Light Emitting Diode

LOB - Left Out Board

LOC - Localizer

LON - Longitude

T.O. 1T-38C-1

LONG - Longitude

LOS - Line Of Sight

LRU - Line Replaceable Unit

LVL - Level

LWT - Left Wing Tip

M

MA - Master Arm

MACS - Minimum Acceleration Check Speed

MAG - Magnetic

MAINT - Maintenance

MALF - Malfunction

MAN - Manual

Max - Maximum

MB-# - MFD Bottom OSB

MDA - Minimum Decision Altitude

MDP - Mission Display Processor

MFD - Multifunctional Display

MFL - Maintenance Fault List

MGRS - Military Grid Reference System

MH - Manual Heading

MHz - Megahertz

MIC - Microphone

Min - Minimum

MINIMA - Minimum Altitude

ML-# - MFD Left OSB

MMS - Master Mode Switch

MOR - Manual Override Handle

MPC - Mission Planning Center

MR-# - MFD Right OSB

MRK - Mark

mr - Milliradian

mrاد - Milliradian

ms - Millisecond

msec. - Millisecond

MSL - Mean Sea Level

MT-# - MFD Top OSB

N

NACS - Normal Acceleration Check Speed

NARPT- Nearest Airport

NAV - Navigation

NDBS - No Drop Bomb Scoring

NM/NMI - Nautical Mile

NOP - Normal Operation Procedures

NOR - Normal

NORM - Normal

NOZ - Nozzle

NP - Non Precision Approach

NT - Night

NV - Navigation

NWS - Nose Wheel Steering

NXT - Next

O

OSB - Option Select Button

P

PFL - Pilot Fault List

PFR - Primary Flight Reference

Pickle - Weapons Release Button

PNS - Primary Navigation Source

PP - Present Position

PPH - Pounds Per Hour

PSI - Pounds per Square Inch

PST - Preset

PSU - Power Supply Unit

PTT - Push To Talk

PU - Position Update

PUB - Power Up Bit

Q

QNH - Field Elevation Corrected For MSL (altimeter setting)

R

R - RALT In HUD

RA - Resolution Advisory

RAD - Radial

RALT - Radar Altimeter

RB - Relative Bearing

RD - Raw Data

REC - Record

RLG - Ring Laser Gyro

ROB - Right Out Board

RPM - Revolutions Per Minute

RPTR - Repeater

RST - Reset

R/T - Receiver Transmitter

RTN - Return

RWT - Right Wing Tip

RWY - Runway

S

SAT - Satellite

SBY - Standby

SC - Selected Course

SCA - Self Contained Approach

SCANP - Self Contained Approach Non-Precision

SCOR - Score (NDBS Display)

Sec - Second/Seconds

SH - Stored Heading

SMS - Store Management System

SPD - Speed

SQ - Squelch

SRM - Short Range Missile

SSK - Seat Survival Kit

STAT - Status

STBY - Standby

STR - Steer

T

TA - Traffic Advisory

TACAN - Tactical Air Control And Navigation

TAS - True Air Speed

TAT - Total Air Temperature

TBD - To Be Determined

TCAS - Traffic Collision and Avoidance System

TCS - TCAS

TD - Target Designator

T.O. 1T-38C-1

TEMP - Temperature

TFOV - Total Field Of View

TGT - Target

TO - Technical Order

TOD - Time Of Day

TOT - Time-on-Target

TR - Transmit and Receive

T/R - Transmitter/Receiver

TRU - Transformer-Rectifier Unit

TST - Test

TTG - Time To Go

U

UFCP - Up Front Control Panel

UHF - Ultra High Frequency

UL-# - UFCP Left OSB

UM - UHF Manual

UOSB - UFCP OSB

UP - UHF Preset

UR-# - UFCP Right OSB

UTM - Universal Transverse Mercator

V

VAC - Volts, Alternating Current

VDC - Volts, Direct Current

VDI - Vertical Deviation Indicator

VFR - Visual Flight Rules

VHF - Very High Frequency

VID - VOR/ILS/DME

VM - VHF Manual

VOR - VHF Omnidirectional Range

VP - VHF Preset

VTR - Video Tape Recorder

VVI - Vertical Velocity Indicator

W

WDST - Weapon Delivery Status

WGS - World Geodetic System

WLS - Wheels

WLU - Wheels Lock-Up

WOW - Weight-On-Wheels

WPN - Weapon

WSSP - Weapon System Support Pod

Y

YSAS - Yaw Stability Augmentor System

ALPHABETICAL INDEX

2

2.5° DESCENT REFERENCE
 LINE 1-152, 1-166

A

A/A MASTER MODE 1-90
 AAP CONTROLS 1-92
 AAP TCAS CONTROLS 1-352
 ABORT 3-20
 ABRUPT AND UNCOMMANDED
 AIRCRAFT PITCH-UP,
 FLAPS EXTENDED 3-48
 AC ADVISORY DISPLAYS 1-39
 AC POWER SYSTEM 1-39
 ACKNOWLEDGE (ACK) FUNCTION
 KEY 1-123
 ACP TCAS CONTROLS 1-352
 ADC IBIT (MR-4) 1-393
 ADDITIONAL EQUIPMENT 1-396
 ADVISORIES 1-388
 AFTER EJECTION 3-56, 3-64
 AFTER LANDING 2-32
 AFTER TAKEOFF 2-27
 AFTERBURNER FUEL CONTROL 1-29
 AFTERBURNER SYSTEM 1-29
 A/G MASTER MODE 1-90
 AIR DATA COMPUTER (ADC) 1-91
 AIRCRAFT 1-4
 AIRCRAFT WATERLINE 1-157
 AIRCREW INITIATED POST FLIGHT
 DATA TRANSFER FROM
 MDP TO DTC 1-365
 AIRCREW/SEAT SEPARATION 1-85, 3-62
 AIRFRAME MOUNTED GEARBOX 1-29
 AIRSPEED DIAL AND
 DIGITAL READOUT 1-157
 AIRSPEED LIMITATIONS 5-1
 AIR-TO-AIR TACAN (AAT) 1-333
 AIR-TO-AIR TACAN RANGE 1-140, 1-157
 ALIGNMENT 1-240
 ALPHABETIC KEYPAD 1-110
 ALTERNATE AIRSTART/LOSS OF
 THRUST (LOW ALTITUDE) 3-44
 ALTERNATE FUELS 2-43
 ALTIMETER 1-180
 ALTITUDE (ALT) FUNCTION KEY 1-119
 ALTITUDE WARNING 1-143, 1-383
 ALTITUDE WARNING SETTING 1-185

ANGLE OF ATTACK (AOA)
 INDICATOR 1-182
 ANGLE OF ATTACK (AOA) SYSTEM 1-61
 ANTI-G SUIT HOSE 1-69, 1-85
 ANTI-G SUIT SYSTEM 1-58
 ANTI-G VALVE 1-58
 AOA INDEXER 1-61
 AOA INDEXER LIGHTS 1-381
 AOA INDEXER LIGHTS
 DIMMER CONTROL 1-62
 AOA INDICATOR DISPLAY 1-61
 AOA SYMBOL 1-153
 AOA SYSTEM OVERVIEW 1-61
 AOA VANE ANTI-ICING 1-58
 APPROACH AND LANDING 7-4
 APPROACH (APP) FUNCTION KEY 1-135
 ASSYMMETRICAL G 6-7
 ASYMMETRICAL FLIGHT
 ATTENUATION (ATTEN) SWITCHES 1-349
 ATTITUDE (ATT) MODE 1-247
 AUDIO CONTROL
 PANEL (ACP) 1-310, 1-318, 1-328, 1-347
 AUTOMATIC BACKUP UNIT
 OPERATION (ABU) 1-85
 AUTOMATIC POST FLIGHT DATA
 TRANSFER FROM MDP TO DTC 1-365
 AUTOMATIC-OPENING SAFETY BELT 1-69
 AUXILIARY FLAP CONTROL SWITCH 1-55
 AVIONICS ACTIVATION PANEL (AAP) 1-91
 AVIONICS CAUTION 1-387
 AVIONICS MALFUNCTIONS 3-83
 AVIONICS MASTER MODES 1-90
 AVIONICS MASTER MODE/
 SUBMODE BLOCK 1-143, 1-158
 AVIONICS OVERVIEW 1-90
 AVIONICS SYSTEMS 1-90

B

BACKUP CONTROL PANELS 1-337
 BACKUP CONTROL PANELS
 OVERVIEW 1-337
 BANK SCALE/ARROW AND SLIP
 INDICATOR (NAV
 MODE ONLY) 1-143, 1-158
 BANK STEERING 1-280
 BAROMETRIC ALTITUDE DIAL AND
 INDICATOR 1-159
 BAROMETRIC ALTITUDE SCALE AND
 INDICATOR 1-144

T.O. 1T-38C-1

BAROSTATIC TIME RELEASE	
UNIT (BTRU).....	1-84
BARRIER ENGAGEMENT	3-22
BASIC FLIGHT INSTRUMENTS	1-176
BATTERY SWITCH.....	1-40
BEARING ARROW SUB-MENU	
DISPLAY	1-117
BEARING ARROW/RADIAL	
READOUT.....	1-145, 1-159
BEFORE EJECTION	3-56, 3-64
BEFORE EXTERIOR INSPECTION	
(WITH/WITHOUT	
EXTERNAL POWER).....	2-1
BEFORE FLIGHT.....	7-1, 7-3
BEFORE LANDING	2-29
BEFORE TAKEOFF.....	2-25
BEFORE TAXIING.....	2-23
BEFORE TAXIING.....	2-16
BINGO CAUTION.....	1-387
BOOST PUMP INDICATOR LIGHTS	1-381
BOOST PUMPS INDICATOR LIGHTS	1-35
BOOST PUMPS SWITCHES.....	1-35
BORESIGHT CROSS	1-146
BRAKE SYSTEM MALFUNCTION	
(FLUID VENTING)	3-54
BRIGHTNESS (BRT) ROCKER	
SWITCH.....	1-170
BULLSEYE BEARING	
AND RANGE	1-146, 1-160
BULLSEYE BEARING AND RANGE.....	1-191
BULLSEYE SELECT FUNCTION	
KEY.....	1-127

C

CABIN AIR CONDITIONING AND	
PRESSURIZATION SYSTEM.....	1-57
CABIN PRESSURE LOSS.....	3-39
CABIN PRESSURE REGULATOR AND	
INDICATOR	1-57
CABIN PRESSURE SWITCH	1-57
CABIN TEMPERATURE (TEMP).....	1-57
CALIBRATED AIRSPEED INDICATOR....	1-179
CANOPY.....	1-64, 5-4
CANOPY BREAKER TOOL.....	1-67
CANOPY DEFOG KNOB	1-57
CANOPY JETTISON SYSTEM.....	1-65, 1-79
CANOPY OPERATION	1-64
CANOPY WARNING LIGHT.....	1-65, 1-380
CAUTION LIGHT PANEL.....	1-380
CAUTIONS	1-384
CHAFF/FLARE RELEASE TONE	1-388
CHANGING DATA VIA KEYPAD.....	1-110
CHANGING THE ILS FREQUENCY	1-318

CHANGING THE TACAN CHANNEL.....	1-328
CHARACTERISTICS	6-1
CHRONOMETER (CRN)	1-186
CHRONOMETER TIME.....	1-146, 1-161
CIRCLING APPROACHES.....	2-40
CLIMB	2-27
CLIMB/DIVE MARKER (CDM).....	1-161
CLOCK (CLK) FUNCTION KEY	1-125
COLD WEATHER OPERATION	7-3
COLOR TV SENSOR SYSTEM (CTVS).....	1-372
COMMANDED AIRSPEED	
INDICATOR (SPEED BUG).....	1-166
COMMANDED AIRSPEED	
INDICATORS	1-160
COMMANDED SPEED INDICATOR	
(SPEED BUG).....	1-153
COMMANDED SPEED INDICATORS.....	1-146
COMMUNICATION BACKUP MODE	
OPERATIONS	1-350
COMMUNICATION (COMM)	
ANTENNA SWITCH	1-349
COMMUNICATION (COMM)	
DATA BLOCK	1-190
COMMUNICATION EQUIPMENT	1-347
COMMUNICATION SYSTEM	
OVERVIEW.....	1-347
COMPRESSOR STALL.....	3-47
CONSOLE LIGHTS	1-378
CONTROL STICK.....	1-52
CONTROLLABILITY CHECK /	
STRUCTURAL DAMAGE.....	3-52
COURSE (CRS) ROCKER SWITCH	1-170
COURSE DEVIATION	
INDICATOR (CDI)	1-146, 1-161
COURSE SELECT WINDOW	1-188
CREATING/EDITING FPLs	1-298
CROSSFEED.....	2-40
CROSSFEED Indicator Light	1-36
CROSSFEED INDICATOR LIGHT	1-381
CROSSFEED SWITCH	1-36
CROSSFEEDING.....	1-38
CROSSWIND LANDING.....	2-31
CROSSWIND TAKEOFF.....	2-27
CTVS MARK.....	1-374
CURRENT AOA.....	1-161
CURRENT AOA AND CURRENT	
G LOAD	1-148
CURRENT G LOAD	1-162
CURRENT MACH NUMBER	1-148

D

DATA TRANSFER SYSTEM (DTS).....	1-363
DC BUSES.....	1-40

DC POWER SYSTEM	1-39
DECLUTTER (DCL) FUNCTION KEY	1-125
DEPARTING PREPARED SURFACE	3-17
DESCEND CAUTION	1-388
DESCENT	2-27
DEST DISPLAY	1-278
DESTINATION DATABASE	
MANAGEMENT	1-284
DESTINATION (DEST) POINT	1-273
DESTINATION (DST) FUNCTION KEY ...	1-284
DESTINATION (DST) FUNCTION KEY ...	1-129
DESTINATION POINT DEFINITIONS	1-284
DEVIATING FROM A FPL	1-299
DIGITAL AERONAUTICAL FLIGHT	
INFORMATION FILE (DAFIF)	1-364
DIGITAL FUEL INDICATOR	1-148, 1-162
DISPLAY TEST (TST)	
FUNCTION KEY	1-126
DITCHING	3-54
DIVERT MODE COMMANDED	
ALTITUDE INDICATOR	1-161
DME CHANNEL ASSOCIATED	
WITH VOR	1-310
DTS CONTROLS AND DISPLAYS	1-363
DTS IBIT (MR-3)	1-393
DTS OVERVIEW	1-363
DUAL ENGINE FAILURE AT	
LOW ALTITUDE	3-44
DUAL TRANSFORMER-RECTIFIER	
FAILURE	3-34
E	
EED CONTROLS	1-11
EED DISPLAYS	5-4
EED ENGINE AND FUEL INDICATORS ...	1-12
EED HOT	3-83
EED INTERNAL BIT FAILURE	3-83
EED INTERNAL FAILURE	3-83
EED MESSAGE WINDOW	1-20
EED MODES OF OPERATION	1-9
EED OVERVIEW	1-8
EED SENSOR FAILURE	3-83
EED TEST AND IBIT	1-394
EFFECT OF ANGLE OF ATTACK	
(AOA) ON ROLL PERFORMANCE	6-7
EFFECT OF BANK ANGLE ON	
VERTICAL VELOCITY	6-4
EFFECTS OF KEY PRESSES	
DURING DATA ENTRY	1-111
EGI DATA OUTPUTS	1-236
EGI FAILURE - GPS	3-83
EGI FAILURE - INS	3-84
EGI FAILURE - TOTAL	3-84
EGI FUNCTION KEY	1-256
EGI HUD AND MFD DISPLAYS	1-240
EGI IBIT (ML-3)	1-391
EGI INFLIGHT ALIGNMENT (IFA)	1-259
EGI NAVIGATION DEFINITIONS	1-272
EGI NAVIGATION DISPLAYS	1-293
EGI NAVIGATION SOLUTIONS	1-246
EGI OFF OR COMPLETELY FAILED	
OPERATION	1-263
EGI OPERATION	1-239
EGI OPERATIONS WITH MDP	
FAILURE	1-263
EGI POWER SWITCH	1-239
EGI STATUS MESSAGES	1-388
EGI SYSTEM OVERVIEW	1-236
EGI WITH GPS FAILED	1-268
EGI WITH INS FAILED	1-268
EGI/NAV DATA BLOCK	1-148, 1-162
EJECTION	3-56
EJECTION	3-64
EJECTION HANDLE	1-77
EJECTION HANDLE OPERATION	1-77
EJECTION PROCEDURE (AFTER T.O.	
1T-38C-546)	3-62
EJECTION PROCEDURE (BEFORE	
T.O. 1T-38C-546)	3-54
EJECTION SEAT	1-68, 1-77
EJECTION SEAT SAFETY PIN	1-68
EJECTION SYSTEM (AFTER	
T.O. 1T-38C-546)	1-77
EJECTION SYSTEM	
(BEFORE T.O. 1T-38C-546)	1-68
EJECTION VS FORCED LANDING	3-54
ELECTRICAL EMERGENCIES	3-26
ELECTRICAL FAILURE - COMPLETE	3-35
ELECTRICAL FIRE	3-35
ELECTRICAL SYSTEMS	1-39
ELECTRONIC ATTITUDE DIRECTION	
INDICATOR (EADI)	1-176
ELECTRONIC ENGINE DISPLAY	
(EED)	1-8
ELECTRONIC HORIZONTAL	
SITUATION INDICATOR (EHSI)	1-192
EMBEDDED GLOBAL POSITIONING	
SYSTEM (GPS)/INERTIAL NAVIGATION	
SYSTEM (INS) (EGI)	1-236
EMBEDDED GPS/INS (EGI)	
FUNCTION KEY	1-136
EMERGENCY DIVERT MODE	1-191
EMERGENCY DIVERT MODE	1-284
EMERGENCY EGRESS	1-73
EMERGENCY ENTRANCE	3-91
EMERGENCY FUELS	2-43

T.O. 1T-38C-1

EMERGENCY GROUND EGRESS (AFTER T.O. 1T-38C-546).....	3-18
EMERGENCY GROUND EGRESS (BEFORE T.O. 1T-38C-546).....	3-17
EMERGENCY OXYGEN CYLINDER.....	1-78
EMERGENCY OXYGEN (EO) HANDLE (Green Ring).....	1-78
ENGINE ANTI-ICE SYSTEM.....	1-58
ENGINE CAUTION	1-385
ENGINE COMPRESSOR STALL/ FLAMEOUT SUSCEPTIBILITY AREA.....	1-31
ENGINE COMPRESSOR STALLS AND FLAMEOUTS	1-31
ENGINE EMERGENCIES	3-40
ENGINE EXHAUST GAS TEMPERATURE (EGT).....	5-4
ENGINE FAILURE/FIRE WARNING DURING TAKEOFF, TAKEOFF CONTINUED	3-21
ENGINE FAILURE/SHUTDOWN DURING FLIGHT.....	3-42
ENGINE FIRE DURING START.....	3-17
ENGINE ICING	7-2
ENGINE IDLE RPM	7-3
ENGINE INDICATORS.....	1-13
ENGINE OIL PRESSURE	7-3
ENGINE OIL PRESSURE (OIL).....	5-5
ENGINE OIL SYSTEM.....	5-9
ENGINE OPERATING LIMITATIONS	5-1
ENGINE OVERTEMPERATURE (LATCHED EGT).....	3-41
ENGINE SHUTDOWN	2-33
ENGINE START	7-3
ENGINE START AND IGNITION SYSTEM.....	1-6
ENGINE TACHOMETER (RPM).....	5-4
ENGINE TEMPERATURE EXCEEDANCE (NON LATCHED EGT)	3-41
ENGINES.....	1-6
ERECT SPIN	6-4
ERRORS DURING UFCP OPERATION	1-113
EXCESSIVE HYDRAULIC PRESSURE (CAUTION LIGHT OFF) (GROUND).....	3-17
EXCESSIVE HYDRAULIC PRESSURE (CAUTION LIGHT OFF) (IN FLIGHT)....	3-25
EXTERIOR INSPECTION.....	2-5
EXTERIOR LIGHTING	1-378
F	
F-16 HUD BASIC SYMBOLS.....	1-140
F-16 HUD DECLUTTER.....	1-154
F-16 HUD GEAR DOWN SYMBOLS.....	1-152
FAILS-TO-TUNE.....	1-335
FIRE WARNING	1-383
FIRE WARNING AND DETECTION SYSTEM.....	1-31
FIRE WARNING DURING FLIGHT (AFFECTED ENGINE)	3-40
FIRE WARNING LIGHTS	1-380
FLAP ASYMMETRY	3-49
FLAP HORIZONTAL TAIL LINKAGE MALFUNCTION	3-50
FLAP SYSTEM	1-55
FLAP-HORIZONTAL TAIL (FLAP- SLAB) INTERCONNECT SYSTEM	1-55
FLAPS.....	5-2
FLAPS LEVER AND POSITION INDICATOR	1-55
FLIGHT CONTROL EMERGENCIES	3-48
FLIGHT CONTROL SYSTEM	1-52
FLIGHT CONTROL SYSTEM OVERVIEW.....	1-52
FLIGHT CONTROLS.....	6-5
FLIGHT DATA BLOCKS	1-185
FLIGHT DIRECTOR (FD)	1-148, 1-162
FLIGHT DIRECTOR LOGIC AND USAGE.....	1-280
FLIGHT LEVEL (FL).....	1-353
FLIGHT PATH MARKER (FPM)	1-149, 1-163
FLIGHT PLAN DATABASE MANAGEMENT	1-297
FLIGHT PLAN DEFINITIONS.....	1-297
FLIGHT PLAN (FPL) FUNCTION KEY	1-127
FLIGHT PLAN NAVIGATION.....	1-298
FLIGHT PLAN OPERATIONS IF EGI IS NOT THE PNS	1-305
FLIGHT PLAN WAYPOINT	1-273
FLIGHT PLANS (FPL)	1-274
FLOOD LIGHT.....	1-378
FLUCTUATING NOZZLE.....	3-42
FORMATION LIGHTS	1-379
FPL DISPLAY	1-278
FPL NAVIGATION DISPLAYS.....	1-299
FREQUENCY SELECTION	2-41
FUEL BALANCING	2-40
FUEL BOOST PUMPS.....	1-35
FUEL CONTROL SYSTEM	1-29
FUEL CROSSFEED	1-36
FUEL DISPLAYS.....	1-36
FUEL EMERGENCIES	3-37
FUEL FLOW AND FUEL QUANTITY.....	1-36
FUEL FLOW (FF).....	5-5
FUEL INDICATORS.....	1-18
FUEL LOW CAUTION LIGHT.....	1-36
FUEL MANAGEMENT.....	1-38

FUEL PRESSURE CAUTION LIGHTS 1-35
 FUEL QUANTITY (FQ)..... 5-5
 FUEL QUANTITY INDICATOR AND
 LOW-LEVEL CAUTION LIGHT
 SYSTEM MALFUNCTION..... 3-37
 FUEL SHUTOFF SWITCHES..... 1-36
 FUEL SYSTEM 1-35, 5-9
 FUEL SYSTEM OVERVIEW..... 1-35

G

G METER 1-183
 G OVERSHOOT..... 6-5
 GEAR WARNING 1-384
 GEARBOX FAILURE - AIRFRAME
 MOUNTED 3-25
 GEARBOX FAILURE TO SHIFT..... 3-34
 GENERAL 5-1
 GENERATOR FAILURE - PARTIAL 3-34
 GENERATOR FAILURE (IN FLIGHT) 3-33
 GENERATOR FAILURE
 (NO AC CROSSOVER)..... 3-33
 GENERATOR SWITCHES AND
 CAUTION LIGHTS..... 1-39
 GO-AROUND 2-32
 GPS/INS BASED NAVIGATION 1-284
 GROUND BASED NAVIGATION..... 1-307
 GROUND BASED NAVIGATION
 OVERVIEW..... 1-307
 GROUND EGRESS..... 1-73, 1-85
 GROUND EMERGENCIES 3-17
 GROUND SPEED 1-186

H

HANDGRIPS..... 1-68
 HANDS ON THROTTLE AND
 STICK (HOTAS) 1-93
 HEADING (HDG) SET MARKER
 ROCKER SWITCH 1-170
 HEADING SCALE AND INDICATOR 1-149,
 1-153, 1-163
 HEADING SET MARKER 1-149, 1-163
 HEAD-UP DISPLAY (HUD)..... 1-139
 HEAD-UP DISPLAY (HUD)
 FUNCTION KEY..... 1-124
 HIGH SPEED DIVE RECOVERY 6-7
 HOLDING PATTERNS..... 2-35
 HORIZON LINE..... 1-150, 1-163
 HORIZONTAL SITUATION
 DISPLAY (HSD) 1-198
 HOT KEYS 1-138
 HOT WEATHER/DESERT OPERATION 7-4

HSD MFD OPTION SELECT
 BUTTON (MOSB) LABELS
 AND FUNCTIONS 1-204
 HSD NAVIGATION SYMBOLS 1-200
 HUD and HUD CTVS CAMERA
 POWER SWITCH 1-140
 HUD AND/OR UFCP FAILURE..... 3-87
 HUD BRIGHTNESS (H BRT)
 ROCKER SWITCH 1-140
 HUD CONTROLS 1-140
 HUD CONTROLS AND DISPLAYS..... 1-139
 HUD FUNCTION KEY 1-140
 HUD SYSTEM OVERVIEW..... 1-139
 HUD TCAS DISPLAYS 1-356
 HYDRAULIC CAUTION LIGHTS 1-47
 HYDRAULIC EMERGENCIES..... 3-24
 HYDRAULIC MALFUNCTION
 (CAUTION LIGHT(S) ON)..... 3-24
 HYDRAULIC PRESSURE 5-10
 HYDRAULIC PRESSURE INDICATORS 1-47
 HYDRAULIC SYSTEMS..... 1-47
 HYDRAULIC SYSTEMS
 MALFUNCTIONS 3-24

I

ICAO DISPLAY 1-278
 ICAO POINTS..... 1-273
 ICE INGESTION 7-2
 ICING 7-2
 IDENT (IDT) 1-353
 IDENT (IDT) FUNCTION KEY 1-127
 IDENTIFICATION FRIEND OR
 FOE (IFF) FUNCTION KEY 1-133
 IDENTIFICATION FRIEND OR
 FOE (IFF)/ TRAFFIC COLLISION
 AVOIDANCE SYSTEM (TCAS) 1-351
 IFF SYSTEM OVERVIEW 1-351
 IFF/TCAS CONTROLS 1-352
 IFF/TCAS MODES 1-352
 ILS APPROACH..... 2-36
 ILS CONTROLS..... 1-317
 ILS COURSE SELECTION..... 1-320
 ILS DISPLAYS..... 1-315
 ILS MFD/HUD CDI DATA DISPLAY..... 1-320
 ILS NAVIGATION 1-320
 ILS NAVIGATION BACKUP
 OPERATIONS 1-320
 ILS NORMAL/BACKUP MODE
 CONTROL 1-317
 ILS POWER CONTROL 1-317
 ILS/DME DISPLAYS 1-320
 INCREMENT/DECREMENT 1-111
 INERTIAL REEL LOCK..... 1-69

MAXIMUM ALLOWABLE AIRSPEED 5-1
 MAXIMUM THRUST 5-1
 MDP DEGRADED..... 3-87
 MDP FAILURE 3-89
 MDP OPERATION DURING
 ELECTRICAL POWER
 INTERRUPTIONS 1-90
 MDP REBOOT 3-89
 MENU DISPLAY OPTIONS 1-207
 MESSAGE WINDOW 1-150, 1-153, 1-164
 MFD BACKUP DISPLAY..... 1-231
 MFD CONTROLS 1-169
 MFD DISPLAYS 1-171
 MFD FAILURE 3-87
 MFD ILS CONTROLS AND DISPLAYS 1-317
 MFD LOAD OP 1 DISPLAY PAGE 1-364
 MFD LOAD OP 2 DISPLAY PAGE 1-364
 MFD LOAD TO MDP DATA
 TRANSFER PAGES 1-363
 MFD MENU AND FUNCTION
 DISPLAY PAGES 1-206
 MFD MULTILEVEL MENU CONTROL 1-206
 MFD NAV AND COMM DATA..... 1-188
 MFD NAVIGATION CONTROLS AND
 DISPLAYS..... 1-278
 MFD OPTION SELECT
 BUTTONS (MOSBs)..... 1-170
 MFD OVERVIEW 1-169
 MFD TACAN CONTROLS 1-328
 MFD TCAS CONTROLS AND
 DISPLAYS..... 1-353
 MFD VOR CONTROLS 1-310
 MFD WITNESS MARK..... 1-374
 MFDA IBIT (MR-7) 1-393
 MFDF IBIT (MR-6)..... 1-393
 MILITARY THRUST..... 5-1
 MIL-STD HUD BASIC SYMBOLS..... 1-154
 MIL-STD HUD DECLUTTER..... 1-168
 MIL-STD HUD GEAR DOWN SYMBOLS... 1-166
 MINIMUM CREW REQUIREMENT..... 5-1
 MINIMUM ROLL LANDING 2-31
 MISCELLANEOUS COMMUNICATION
 EQUIPMENT CONTROLS..... 1-349
 MISCELLANEOUS EMERGENCIES 3-54
 MISCELLANEOUS EQUIPMENT 1-396
 MISCELLANEOUS LIMITATIONS..... 5-9
 MISSED APPROACH PROCEDURE..... 2-40
 MISSION DISPLAY PROCESSOR (MDP).... 1-90
 MODE A 1-353
 MODE C 1-353
 MULTIFUNCTIONAL DISPLAY (MFD).... 1-169

N

NAV BACKUP CONTROL PANEL 2-41
 NAV BACKUP CONTROL PANEL 1-337
 NAV DATA BLOCK 1-190
 NAV FAILURE..... 3-89
 NAV FAILURE TO TUNE 3-90
 NAV MASTER MODE..... 1-90
 NAV SOURCE SUB-MENU DISPLAY 1-117
 NAV SUB-MENU DISPLAY 1-116
 NAVAID (BACKUP MODE) SUB-MENU
 DISPLAY 1-117
 NAVAID SUB-MENU DISPLAY..... 1-117
 NAVIGATION CONTROLS 1-272
 NAVIGATION CONTROLS
 AND DISPLAYS..... 1-277
 NAVIGATION DATA LOADING 1-276
 NAVIGATION DISPLAYS 1-272
 NAVIGATION OVERVIEW 1-272
 NAVIGATION SOURCE 1-274
 NAVIGATION TO A STEERPOINT 1-293
 NAVIGATION TUNING 1-335
 NAVIGATION USING THE
 LOCALIZER AND BACK COURSE..... 1-320
 NEAREST AIRPORTS..... 1-297
 NEAREST AIRPORTS DATABASE 1-273
 NEAREST AIRPORTS DISPLAY..... 1-278
 NO BREAK (BRK) X CAUTION 1-388
 NO FLAP LANDING 3-76
 NON PRECISION APPROACHES 2-36
 NORMAL EGRESS 1-73, 1-85
 NORMAL LANDING 2-29
 NORMAL THRUST 5-1
 NORMAL TUNING 1-335
 NOSEWHEEL CENTERING
 MECHANISM..... 1-51
 NOSEWHEEL STEERING 5-4
 NOSEWHEEL STEERING
 (NWS) SYSTEM 1-51
 NOSEWHEEL TIRE..... 5-10
 NOZZLE FAILURE..... 3-41
 NOZZLE POSITION (NOZ) 5-4
 NOZZLE STUCK CLOSED
 (AT OR NEAR ZERO) 3-42
 NOZZLE STUCK OPEN (IN THE
 OPEN RANGE, 20-100 %) 3-42
 NT/AUT/DAY SWITCH 1-140
 NUMERIC KEYPAD 1-110
 NWS SWITCH 1-51

O

OFF/NIGHT/DAY (OND) POWER
 KNOB 1-170

T.O. 1T-38C-1

OIL SYSTEM	1-29
OIL SYSTEM MALFUNCTION	3-41
OTHER BUILT-IN TEST (BIT) MODES ...	1-393
OTHER EMERGENCIES	3-91
OWNSHIP AIRCRAFT SYMBOL	1-355
OXYGEN AND COMMUNICATION	
QUICK DISCONNECT ASSEMBLY	1-68
OXYGEN CHECK SYSTEM	1-88
OXYGEN, COMMUNICATION AND	
ANTI-G SUIT DISCONNECT	1-85
OXYGEN EMERGENCIES	3-39
OXYGEN LOW LEVEL CAUTION LIGHT ..	1-88
OXYGEN QUANTITY	1-88
OXYGEN QUANTITY INDICATOR	1-88
OXYGEN REGULATOR PANEL	1-88
OXYGEN SUPPLY PRESSURE GAUGE	1-88
OXYGEN SYSTEM	1-88
OXYGEN SYSTEM EMERGENCY	
OPERATION	3-39

P

PARACHUTE ASSEMBLY	1-79
PARACHUTE STEERING LINES	1-85
PENETRATION DESCENTS	2-35
PERSONAL LOCATOR BEACON	1-85
PERSONNEL LOCATOR BEACON	1-71
PFR OPTION SELECT BUTTONS	
(OSB) LABELS AND FUNCTIONS	1-194
PILOT FAULT LIST	3-3
PILOT INDUCED OSCILLATIONS	6-6
PITCH LADDER	1-150, 1-164
PITCH STEERING	1-281
PITOT BOOM ANTI-ICING	1-60
PITOT STATIC SYSTEM	
MALFUNCTION	3-72
PITOT-STATIC SYSTEM	1-60
PITOT-STATIC SYSTEM OVERVIEW	1-60
PNEUMATIC SYSTEM	1-57
PNEUMATIC SYSTEM OVERVIEW	1-57
POSITION LIGHTS	1-379
POST STALL GYRATIONS	6-4
PPA DATA	1-341
PPA DATA LOADING	1-341
PPA OVERVIEW	1-341
PPA SELECTION	1-341
PPA VOR/ILS/DME APPROACHES	1-344
PREFLIGHT CHECK	2-1
PREFLIGHT INSPECTION	7-1
PREFLIGHT PLANNED MISSION DATA	
TRANSFER FROM DTC TO MDP	1-363
PREPROGRAMMED APPROACHES	
(PPA)	1-341
PRESET CHANNEL SELECTION	2-40

PRIMARY EGI SOURCE	1-276
PRIMARY FLIGHT REFERENCE (PFR) ...	1-192
PRIMARY NAVIGATION SOURCE	
(PNS)	1-274
PROGRAMMING PRESET OR GUARD	
CHANNELS	2-41
PROHIBITED MANEUVERS	5-7

R

RA VERTICAL MANEUVERING	
COMMAND DISPLAY	1-355
RADAR ALTIMETER (RALT)	
READOUT	1-150, 1-165
RADAR ALTITUDE (RALT)	1-185
RADAR APPROACHES	2-35
RAIN	7-3
RALT IBIT (ML-5)	1-391
RANGE DATA BLOCK	1-188
RANGE SCALES	1-355
RELATIVE ALTITUDE DISPLAY	
LIMITS	1-353
RESOLUTION ADVISORY (RA)	1-352
RESTART DURING FLIGHT	3-43
REVIEWING FPLs	1-298
RIGHT ESSENTIAL 28 VOLT DC BUS	
FAILURE	3-36
ROLLS	5-7, 6-6
ROTATING BEACON LIGHTS	1-379
RPM EXCEEDANCE (LATCHED RPM)	3-41
RUDDER LIMITER	1-53
RUDDER PEDAL ADJUSTMENT	
T-HANDLE	1-53
RUDDER SYSTEM	1-53
RUDDER SYSTEM MALFUNCTIONS	3-51
RUDDER TRIM	1-53

S

SAFE/ARM LEVER	1-77
SCA CONTROLS AND DISPLAYS	1-342
SCA NAVIGATION	1-344
SEAT ADJUST SWITCH	1-78
SEAT ADJUSTMENT SWITCH	1-68
SEAT PACK	1-71
SEAT SURVIVAL KIT (SSK)	1-78
SECONDARY NAVIGATION SOURCE	1-275
SECONDARY SPEED DISPLAY	1-160
SELECTED COURSE AND	
RANGE	1-151, 1-165
SELECTING A FLIGHT PLAN	
AS THE EGI SOURCE	1-298
SELECTING A FPL	1-298
SELECTING A STEERPOINT	1-293

SELECTING A WAYPOINT	1-298		
SELF CONTAINED APPROACH (SCA).....	1-342		
SERVICING DIAGRAM.....	1-396		
SET FUNCTION KEY	1-120		
SHOULDER HARNESS INERTIA			
REEL LEVER.....	1-78		
SINGLE-ENGINE APPROACHES.....	3-76		
SINGLE-ENGINE FLIGHT			
CHARACTERISTICS	3-40		
SINGLE-ENGINE GO-AROUND	3-76		
SINGLE-ENGINE LANDING	3-77		
SINGLE-ENGINE MISSED APPROACH.....	3-76		
SMOKE, FUMES, OR ODORS IN			
COCKPIT (GROUND)	3-71		
SMOKE, FUMES, OR ODORS IN			
COCKPIT, IN FLIGHT	3-39		
SNOW, ICE, RAIN AND SLUSH	7-1		
SPECIAL FLIGHT LIMITATIONS	5-7		
SPEED BRAKE SWITCH.....	1-56		
SPEED BRAKE SYSTEM.....	1-56		
SPEED SCALE	1-153		
SPEED SCALE AND INDICATOR	1-151		
SPEED WORM.....	1-167		
SPINS	5-7		
SPINS	6-4		
STABILITY AUGMENTATION.....	6-5		
STABILITY AUGMENTOR			
MALFUNCTION	3-51		
STALL RECOVERIES	6-1		
STALL WARNING	1-383		
STALLS	6-1		
STANDBY	1-353		
STANDBY AIRSPEED INDICATOR.....	1-376		
STANDBY ALTIMETER	1-376		
STANDBY ATTITUDE INDICATOR.....	1-375		
STANDBY COMPASS	1-377		
STANDBY INSTRUMENTS	1-375		
STANDBY VERTICAL VELOCITY			
INDICATOR (VVI)	1-377		
STARTING ENGINES.....	2-16, 2-23		
STATIC INVERTER.....	1-40		
STEERPOINT	1-272		
STEERPOINT	1-191		
STICK FORCES.....	6-6		
STICK GRIP SWITCHES.....	1-93		
STRANGE FIELD PROCEDURES.....	2-42		
STRAP IN CONNECTIONS.....	1-69, 1-79		
SUBSONIC ACCELERATED STALLS.....	6-4		
SURVIVAL KIT.....	1-71		
SYMMETRICAL FLIGHT			
SYSTEMS MONITORING AND TEST	1-391		
		T	
		TACAN CONTROLS.....	1-327
		TACAN COURSE SELECTION.....	1-330
		TACAN DISPLAYS.....	1-325, 1-330
		TACAN IBIT (MR-2)	1-393
		TACAN MFD/HUD CDI DATA DISPLAY...	1-330
		TACAN NAVIGATION	1-330
		TACAN NAVIGATION BACKUP	
		OPERATIONS	1-330
		TACAN NORMAL/BACKUP	
		MODE CONTROL.....	1-327
		TACAN POWER CONTROL	1-327
		TAKE COMMAND SWITCH.....	1-93
		TAKEOFF	2-26, 7-4
		TAKEOFF EMERGENCIES.....	3-20
		TAKEOFF TRIM LIGHT	1-381
		TARGET DESIGNATOR	
		(TD) BOX.....	1-152, 1-153, 1-165, 1-166
		TAT PROBE.....	1-60
		TAXIING	2-25, 7-2
		TCAS AURAL ALERTS.....	1-358
		TCAS DISPLAY DECLUTTER, ML-6.....	1-355
		TCAS IBIT (ML-4)	1-391
		TCAS (IFF) FAILURE.....	3-90
		TCAS INTRUDER DISPLAY.....	1-354
		TCAS INTRUDER DISPLAY	
		PRIORITIES	1-354
		TCAS LIMITATIONS.....	1-359
		TCAS MODE DISPLAY.....	1-353
		TCAS MODES AND DISPLAYS.....	1-353
		TCAS RA TRAFFIC AURAL ALERTS.....	1-358
		TCAS RESOLUTION ADVISORY	1-355
		TCAS SYSTEM OVERVIEW.....	1-351
		TCAS TA TRAFFIC AURAL ALERT	1-358
		TERRAIN CLEARANCE.....	3-63
		TEST DISPLAY PAGE	1-391
		THROTTLE BINDING	3-71
		THROTTLE MOVEMENT	1-32
		THROTTLE SETTING	
		THRUST DEFINITIONS	5-1
		THROTTLE SWITCHES	1-93
		THROTTLES	1-7
		TIME DELAY UNIT (TDU).....	1-85
		TIME OF DAY (TOD)	1-152, 1-166, 1-186
		TIME TO GO (TTG).....	1-191
		TIRE FAILURE DURING TAKEOFF,	
		TAKEOFF CONTINUED	3-22
		TOT CALCULATIONS	1-305
		TOUCH AND GO LANDINGS.....	2-32
		TRAFFIC ADVISORY (TA)	1-352
		TRAINING ZONES/NO-FLY	
		ZONES DISPLAY	1-278
		TRIM BUTTON.....	1-53

T.O. 1T-38C-1

TRIM MALFUNCTION.....	3-50
TRIM SYSTEM	1-53
TURBULENCE AND THUNDERSTORMS	7-1

U

UFCP APPROACH (APP) FUNCTION KEY.....	1-342
UFCP BASIC MENU DISPLAY	1-113
UFCP CONTROLS AND DISPLAYS.....	1-99
UFCP DATA ENTRY.....	1-110
UFCP DISPLAY WINDOWS AND OPTION SELECT BUTTONS (OSBs).....	1-100
UFCP FUNCTION KEYS	1-118
UFCP IFF FUNCTION KEY	1-352
UFCP IFF/TCAS CONTROLS AND DISPLAYS.....	1-352
UFCP ILS CONTROLS AND DISPLAYS....	1-317
UFCP NAVIGATION CONTROLS AND DISPLAYS.....	1-277
UFCP OVERVIEW	1-99
UFCP POWER SWITCH.....	1-99
UFCP TACAN CONTROLS	1-327
UFCP VOR CONTROLS	1-310
UFCP VTR Display Indications	1-372
UFCPF IBIT (ML-6).....	1-393
UFCP/HUD DISPLAY BRIGHTNESS CONTROL	1-99
UFCPR IBIT (ML-7).....	1-393
UHF BACKUP CONTROL PANEL.....	1-339
UHF CONTROL VIA UHF BACKUP CONTROL PANEL	2-40
UHF DEGRADE.....	3-90
UHF TOTAL FAILURE.....	3-90
UHF/VHF CONTROLS AND DISPLAYS, UFCP	1-350
UHF/VHF DISPLAYS, MFD	1-350
UNCOMMANDED SMOOTH PITCH-UP DURING FLAP EXTENSION.....	3-48
UP FRONT CONTROL PANEL (UFCP)	1-99
USE OF CANOPY BREAKER TOOL	3-19
USE OF WHEEL BRAKES.....	2-31
USING FD WITH A FPL	1-299
UTILITY LIGHTS.....	1-378

V

VALIDITY CHECK.....	1-112
VERTICAL DEVIATION INDICATOR (VDI)	1-147, 1-166
VERTICAL STALLS.....	5-7
VHF TOTAL FAILURE.....	3-90
VIDEO TAPE RECORDER (VTR).....	1-371

VIDEO TAPE RECORDER (VTR) FUNCTION KEY.....	1-121
VOR CONTROLS.....	1-310
VOR COURSE SELECTION	1-312
VOR DISPLAYS.....	1-307
VOR MFD/HUD CDI DATA DISPLAY.....	1-312
VOR NAVIGATION	1-312
VOR NAVIGATION BACKUP OPERATIONS	1-312
VOR NORMAL/BACKUP MODE CONTROL.....	1-310
VOR POWER CONTROL	1-310
VOR/DME DISPLAYS	1-312
VOR/ILS/DME CONTROLS AND DISPLAYS.....	1-344
VOR/ILS/DME NAVIGATION	1-344
VOR/ILS/TACAN FAILURE	3-90
VTR AUTOMATIC RECORDING	1-374
VTR CONTROLS AND DISPLAYS.....	1-371
VTR OPERATING MODES	1-371
VTR RECORDING MODES.....	1-371
VTR SYSTEM OVERVIEW	1-371

W

WAKE TURBULENCE	6-1
WARNING BRIGHT/DIM SWITCH.....	1-381
WARNING TEST SWITCH	1-381
WARNING/CAUTION/ADVISORY DISPLAYS.....	3-3
WARNING/CAUTION/ADVISORY (WCA) INDICATORS.....	1-380
WARNING/CAUTION/ADVISORY (WCA) LIGHTS CONTROLS.....	1-381
WARNING/CAUTION/ADVISORY (WCA) SYSTEM.....	1-380
WARNINGS.....	1-383
WAYPOINT SWITCHING	1-300
WCA TONES.....	1-382
WCA VISUAL AND AURAL TONE PRIORITIES	1-382
WCAs DISPLAYED ON THE HUD AND MFD.....	1-381
WEAPON RELEASE TONE.....	1-388
WEAPONS (WPN) FUNCTION KEY.....	1-137
WEIGHT AND CENTER OF GRAVITY LIMITATIONS.....	5-10
WEIGHT OFF WHEELS/LDG UP SWITCH	1-51
WHEEL BRAKE SYSTEM.....	1-51
WHEEL BRAKES AND TIRES.....	5-10
WIND DIRECTION AND SPEED	1-186
WITNESS (WIT) FUNCTION KEY.....	1-123

WSSP LIMITATIONS 5-10

Y

YAW STABILITY AUGMENTOR

SYSTEM (YSAS) 1-53

YSAS IBIT (MR-5) 1-393

Z

ZENITH/NADIR SYMBOLS 1-150, 1-164

